

LabelWorks LW-600P User's Guide

Contents

LabelWorks LW-600P User's Guide	7
Introduction to Your LabelWorks Printer	8
Product Box Contents	8
Notations Used in the Documentation	9
Label Printer Parts.....	9
Setting Up the Printer.....	11
Connecting the AC Adapter.....	11
Installing Batteries	11
Inserting and Removing Tape Cartridges.....	13
Turning the Printer On and Off	16
Using the Label Printer With Your Mobile Device.....	17
Installing iLabel	17
Enabling Bluetooth Discovery Mode.....	17
Connecting the Label Printer to Your Mobile Device	18
Connecting the Printer to Your Android Device	18
Connecting the Printer to Your iOS Device.....	19
Using the Printer With Your Computer	20
Connecting the Printer to Your Computer.....	20
Using Label Editor for Windows	20
Getting Started With Label Editor	21
Installing Label Editor.....	21
Starting Label Editor	21
Label Editor Main Window	23
Label Editor Toolbars.....	24
Designing Labels With Label Editor.....	26
Creating a Basic Label in Label Editor	27
Setting Default Preferences in Label Editor	30
Working With Blocks in Label Editor	30
Adding Borders in Label Editor	32
Inserting Images in Label Editor.....	33

Inserting Symbols in Label Editor.....	34
Inserting Barcodes in Label Editor	35
Inserting QR Codes in Label Editor.....	37
Inserting Tables in Label Editor.....	39
Inserting the Date and Time in Label Editor	40
Inserting a Background Pattern in Label Editor	41
Inserting Lines and Shapes in Label Editor	43
Inserting Text Art in Label Editor	45
Editing Layout in Label Editor	46
Editing Text Design in Label Editor	48
Creating Special Format Labels Using Label Editor	48
Creating Labels from Imported Data in Label Editor	49
Creating Ribbons With Repeated Patterns in Label Editor.....	53
Creating Equipment Management Labels in Label Editor	54
Using the Label Editor Catalog	56
Creating Numbered Label Sequences in Label Editor	58
Printing Labels With Label Editor.....	60
Printing Labels in Label Editor	60
Label Editor Printer Settings	62
Print-Paste Printing in Label Editor	65
Using Label Editor Lite for OS X.....	68
Getting Started With Label Editor Lite.....	68
Installing Label Editor Lite.....	68
Starting Label Editor Lite.....	69
Label Editor Lite Main Window.....	70
Designing Labels With Label Editor Lite	71
Setting Default Preferences in Label Editor Lite.....	71
Creating a Basic Label in Label Editor Lite.....	73
Formatting Text in Label Editor Lite	74
Inserting Images in Label Editor Lite.....	75
Inserting the Date and Time in Label Editor Lite.....	76
Adding Borders in Label Editor Lite.....	76
Inserting QR Codes in Label Editor Lite	77

Using the Label Editor Lite Wizard	78
Feeding and Cutting the Tape in Label Editor Lite	79
Printing Labels With Label Editor Lite	80
Applying Your Labels.....	81
Applying Standard Labels	81
Iron-on Labels	82
Applying Iron-on Labels	82
Iron-on Label Tips.....	83
Cleaning the Printer	85
Cleaning the Outside of the Printer.....	85
Cleaning the Print Head	85
Solving Problems	87
Checking for Software Updates.....	87
Product Error Messages.....	87
Solutions to Problems Pairing with Bluetooth	89
Solutions When the Printer Does Not Print.....	89
Solutions to Computer Printing Problems.....	90
Solutions When Print Quality Is Poor.....	90
Solutions to Tape Cutting Problems	91
Solutions to Problems With Saved Labels.....	91
Solutions to Problems Attaching Labels	91
Solutions to Problems With Iron-on Labels.....	92
Where to Get Help.....	92
Technical Specifications	94
Label Editor Software System Requirements.....	94
Label Editor Lite Software System Requirements	94
Mobile Device System Requirements.....	95
Label Printer Specifications.....	96
Label Printer Power Supply Specifications.....	96
Notices	98
Important Safety Instructions.....	98
General Label Printer Safety Instructions	98

Tape Cartridge Safety Instructions	99
AC Adapter Safety Instructions.....	100
Battery Safety Instructions.....	100
FCC Compliance Statement.....	101
Trademarks	102
Copyright Notice.....	102
Copyright Attribution	103

LabelWorks LW-600P User's Guide

Welcome to the LabelWorks LW-600P *User's Guide*.

Introduction to Your LabelWorks Printer

See these sections to learn more about your label printer and this manual.

[Product Box Contents](#)

[Notations Used in the Documentation](#)

[Label Printer Parts](#)

Product Box Contents

Make sure your label printer box included all of these parts:

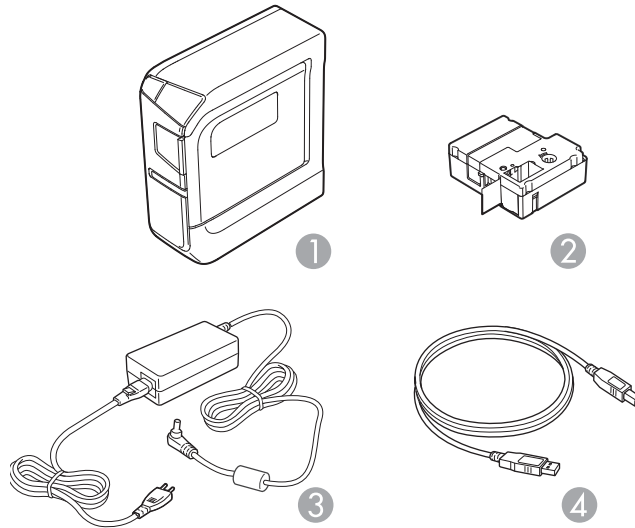

- 1 Printer
- 2 Sample tape cartridge
- 3 AC adapter
- 4 USB cable

Parent topic: [Introduction to Your LabelWorks Printer](#)

Notations Used in the Documentation

Follow the guidelines in these notations as you read your documentation:

- **Warnings** must be followed carefully to avoid bodily injury.
- **Cautions** must be observed to avoid damage to your equipment.
- **Notes** contain important information about your label printer.
- **Tips** contain additional label printing information.

Parent topic: [Introduction to Your LabelWorks Printer](#)

Label Printer Parts

Front

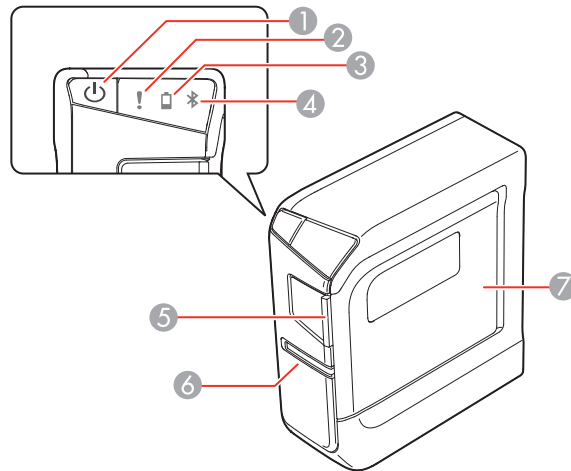

- 1 The ⏻ power button
- 2 The ! error light
- 3 The 🔋 battery light
- 4 The 📶 Bluetooth light
- 5 Tape cover tab

- 6 Tape ejection slot
- 7 Tape cover

Back

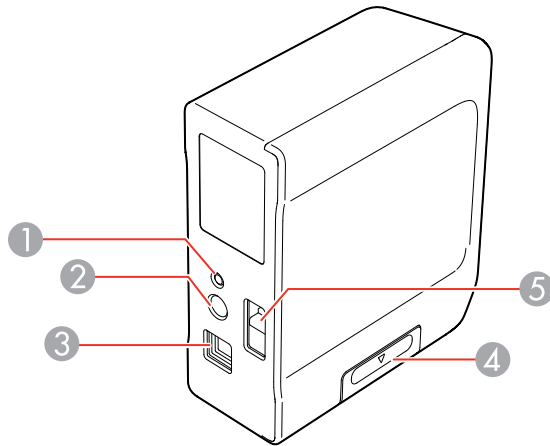

- 1 Bluetooth button
- 2 Power port
- 3 USB port
- 4 Battery cover
- 5 Security cable attachment point

Parent topic: [Introduction to Your LabelWorks Printer](#)

Setting Up the Printer

Follow the instructions in these sections to set up your label printer.

[Connecting the AC Adapter](#)

[Installing Batteries](#)

[Inserting and Removing Tape Cartridges](#)

[Turning the Printer On and Off](#)

Connecting the AC Adapter

Use the AC adapter to power the printer without batteries.

1. Connect the adapter to the printer's AC adapter port.

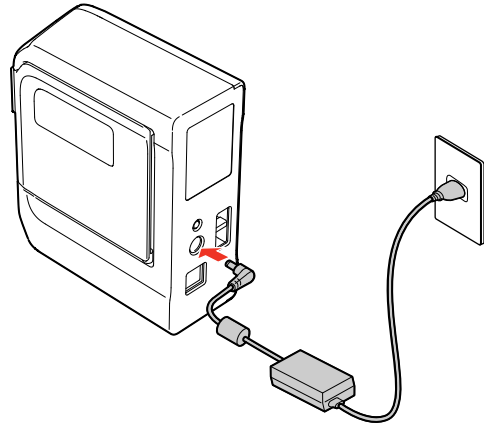

2. Plug the other end of the adapter into an electrical outlet

Parent topic: [Setting Up the Printer](#)

Installing Batteries

You can use batteries instead of the AC adapter when you are not near a power source. The printer requires 6 AA alkaline batteries.

Caution: Make sure the power is off before you install batteries.

Note: Batteries are not included.

1. Press the tab and open the battery cover.

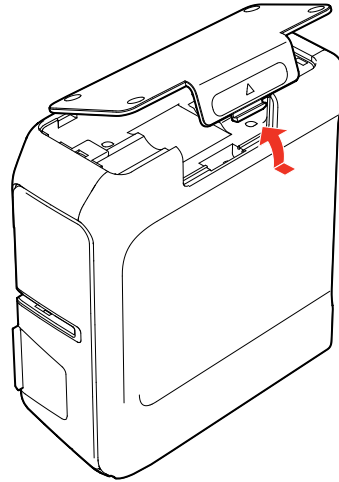

2. Insert the batteries with the + and – ends facing as shown.

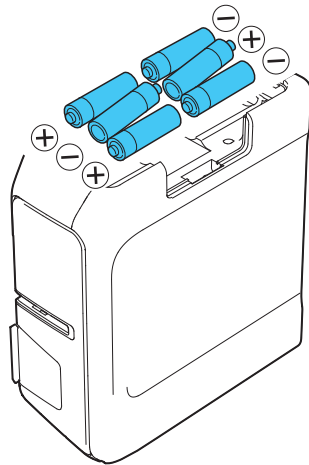

3. Replace the battery cover.

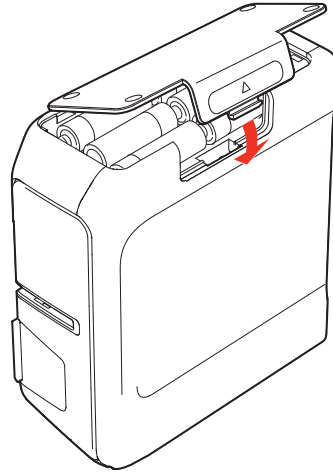

Parent topic: [Setting Up the Printer](#)

Inserting and Removing Tape Cartridges

You can use LabelWorks tapes with widths ranging from approximately 0.25 inch (6 mm) to 1 inch (24 mm). Use only tape cartridges with this mark:



For a complete list of available tape cartridges, go to epson.com/labelworks (U.S.) or epson.ca/labelworks (Canada).

1. Make sure the power is off before you install or remove a tape cartridge.

2. Remove any slack from the tape using a pencil or pen.

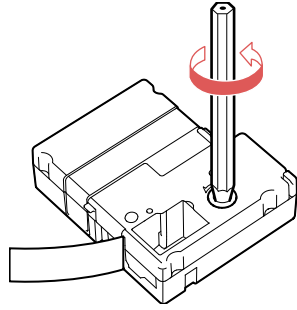

3. Lift up the tape cover.

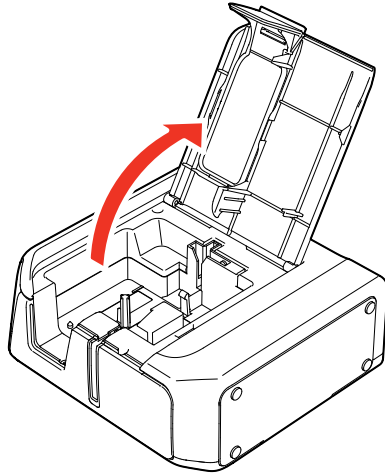

4. Insert the cartridge as shown and press it down firmly until it snaps into place.
Make sure the end of the tape slides into the ejection slot.

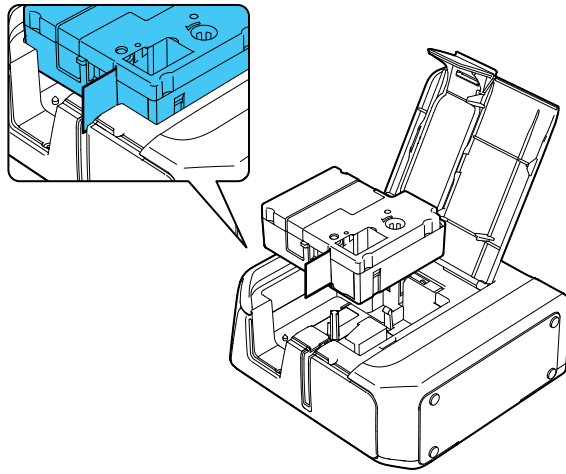

5. Close the tape cover.

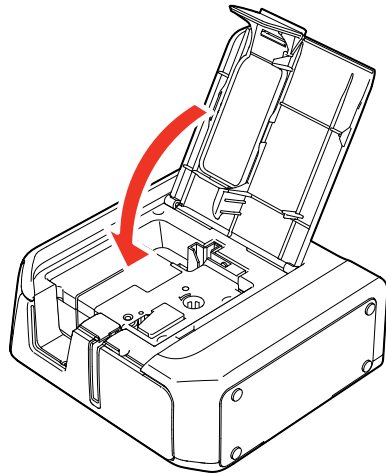

To remove a tape cartridge, open the cover, grasp the sides of the tape, then lift it out of the printer.

Parent topic: [Setting Up the Printer](#)

Turning the Printer On and Off

Make sure the AC adapter is connected or batteries are installed.

- To turn on the printer, press the  power button.

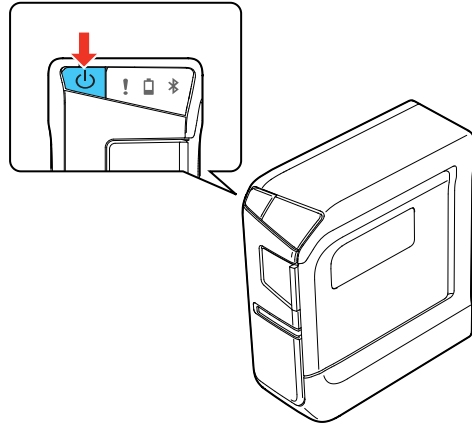

The  Bluetooth light turns on.

Note: The  Bluetooth light flashes at differing intervals depending on the Bluetooth status.

- To turn off the printer, press the  power button.

The printer turns off automatically if it is not used within these time periods:

- 8 hours on AC power
- 20 minutes on battery power

Parent topic: [Setting Up the Printer](#)

Related references

[Product Error Messages](#)

Related tasks

[Connecting the AC Adapter](#)

[Installing Batteries](#)

Using the Label Printer With Your Mobile Device

Follow the instructions in these sections to use the label printer with your mobile device.

[Installing iLabel](#)

[Enabling Bluetooth Discovery Mode](#)

[Connecting the Label Printer to Your Mobile Device](#)

Installing iLabel

Download the Epson iLabel app from the Google Play Store or the App StoreSM.

Parent topic: [Using the Label Printer With Your Mobile Device](#)

Enabling Bluetooth Discovery Mode

Check that Bluetooth is enabled on the printer before connecting.

The ✱ Bluetooth light pulses when Bluetooth is enabled.

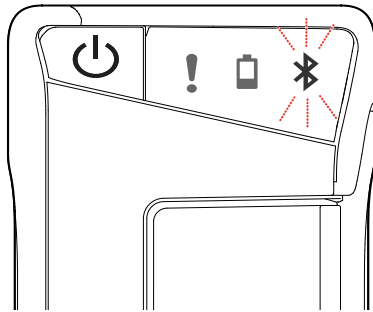

If Bluetooth is disabled, enable it by following the steps below:

1. Press the  power button to turn off the printer.

2. Press the  power button and the Bluetooth button at the same time.

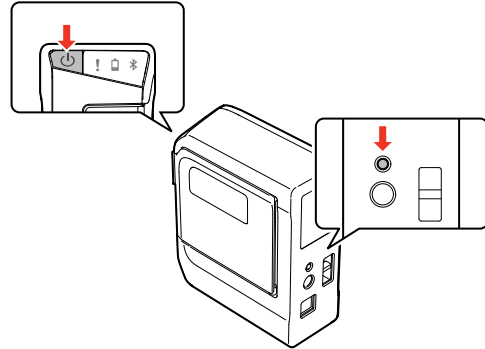

The printer powers on and the  Bluetooth light pulses.

3. Pair your device to the printer using the instructions for your device's operating system.

Parent topic: [Using the Label Printer With Your Mobile Device](#)

Connecting the Label Printer to Your Mobile Device

Follow the instructions in these sections to connect the printer to your mobile device.

[Connecting the Printer to Your Android Device](#)

[Connecting the Printer to Your iOS Device](#)

Parent topic: [Using the Label Printer With Your Mobile Device](#)

Related references

[Solutions to Problems Pairing with Bluetooth](#)

Connecting the Printer to Your Android Device

You can connect the label printer to your Android device using Bluetooth.

1. Turn on your mobile device.
2. Go to **Settings > Wireless & Network** and turn on Bluetooth.
3. Wait while your device scans for the printer.
The printer is displayed when your device finds it.
4. Tap the printer.

Pairing is complete when the printer is listed in the paired devices list.

Note: The  Bluetooth icon in the status bar on your device does not change after pairing is complete, nor does the connection status display on the Bluetooth settings screen.

5. Open iLabel.
6. Tap the  icon.
7. Tap **Printer**.
8. Tap **LW-600P**.

The printer is ready to use when you see this icon on the main screen of iLabel:



Parent topic: [Connecting the Label Printer to Your Mobile Device](#)

Connecting the Printer to Your iOS Device

You can connect the label printer to your iOS device using Bluetooth.

1. Turn on your mobile device.
2. Go to **Settings** > **Bluetooth** and turn on Bluetooth.
3. Wait while your device scans for the printer.

The printer is displayed under **Devices** when the printer is found.

4. Tap the printer.

Pairing is complete when the Bluetooth light on the printer is lit (not flashing).

Parent topic: [Connecting the Label Printer to Your Mobile Device](#)

Using the Printer With Your Computer

Follow the instructions in these sections to use the label printer with your computer.

[Connecting the Printer to Your Computer](#)

[Using Label Editor for Windows](#)

[Using Label Editor Lite for OS X](#)

Connecting the Printer to Your Computer

To use the software with your LabelWorks printer, you need to connect the printer to your computer with the included USB cable.

1. After you install the software (or during the software installation if prompted), connect the USB cable to the printer and your computer.

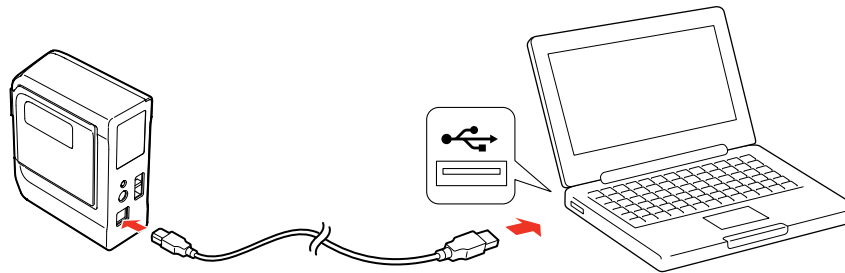

2. Press the  power button on the printer.

Parent topic: [Using the Printer With Your Computer](#)

Using Label Editor for Windows

The Label Editor software makes it easy to create labels and ribbons using your Windows computer, as described in these sections.

[Getting Started With Label Editor](#)

[Designing Labels With Label Editor](#)

[Creating Special Format Labels Using Label Editor](#)

[Printing Labels With Label Editor](#)

Parent topic: [Using the Printer With Your Computer](#)

Getting Started With Label Editor

Follow the instructions in these sections to get started using Label Editor for Windows.

[Installing Label Editor](#)

[Starting Label Editor](#)

[Label Editor Main Window](#)

[Label Editor Toolbars](#)

Parent topic: [Using Label Editor for Windows](#)

Installing Label Editor

Download the software from Epson's support website. Visit the driver download site ([U.S. downloads](#) or [Canadian downloads](#)).

1. Follow the instructions on the screen to install both the application and the driver.
2. When you are prompted to connect the printer to your computer, connect it using the included USB cable.

Parent topic: [Getting Started With Label Editor](#)

Related tasks

[Connecting the Printer to Your Computer](#)

Starting Label Editor

After you have installed the Label Editor software and connected the printer to your computer, you can start using Label Editor.

1. Double-click the  **Label Editor** icon on your Windows Desktop.

You see this window:

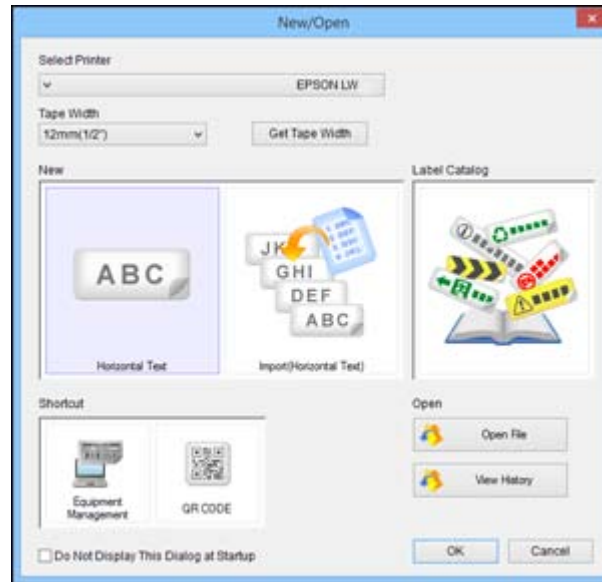

Note: If you want to go directly to the main screen when you start Label Editor, check **Do Not Display This Dialog at Startup**.

2. Select your printer and tape width, if necessary.
3. Do one of the following and click **OK** (or click **Cancel** to go straight to the main Label Editor screen):
 - To start with a blank label, select **Horizontal Text**.
 - To create labels with text from a spreadsheet or other file, select **Import (Horizontal Text)**.
 - To start with a ready-made label from the catalog, select **Label Catalog**.
 - To create an equipment management label or QR code label, select one of the Shortcut options.
 - To open a previously created label, select **Open File** and locate the file on your computer, or select **View History** and select from a list of existing labels.

Parent topic: [Getting Started With Label Editor](#)

Label Editor Main Window

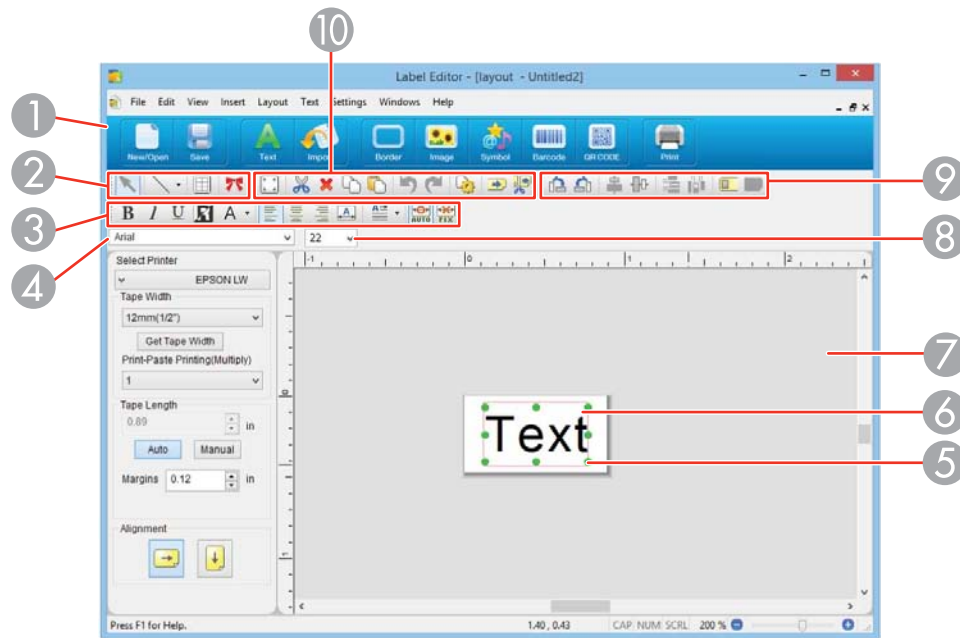

- 1 Operation guide bar
- 2 Edit toolbar
- 3 Text toolbar
- 4 Font box
- 5 Green handle
- 6 Label area (The red line indicates the area that will be printed.)
- 7 Workspace (You can temporarily move a block to this area outside the label.)
- 8 Font size box
- 9 Layout toolbar
- 10 Standard toolbar





Parent topic: [Getting Started With Label Editor](#)

Label Editor Toolbars

The toolbars on the main window provide easy access to the main features of Label Editor.







Edit toolbar







	Select a block for editing
	Draw a line or shape on your label Click the arrow next to the icon to see the available shapes, including polygons, stars, freehand lines, and Bézier curves
	Open a window that lets you design a table to insert on your label
	Open a window that lets you design a ribbon with repeated text or graphic elements, to be printed on ribbon tape

Standard toolbar











	Resize the selected block to fill the label area
	Cut the selected block
	Delete the selected block
	Copy the selected block
	Paste data from the clipboard
	Undo the last action

	Redo the last undo action
	Open the properties window for the selected block
	Feed the tape
	Feed and cut the tape









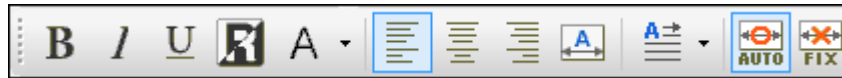



Layout toolbar



	Rotate the selected block 90° counterclockwise
	Rotate the selected block 90° clockwise
	Center the selected block vertically on the label
	Center the selected block horizontally on the label
	Evenly distribute multiple blocks horizontally
	Evenly distribute multiple blocks vertically
	Align the selected block at the beginning of the label
	Align the selected block at the end of the label

Text toolbar



	Make the selected text bold
	Make the selected text italic
	Underline the selected text
	Reverse the selected text and background (change black text on white background to white on black)
	Change the text style Click the arrow next to the icon to select outlining and other special effects
	Align the text with the left side of the block
	Align the text in the center of the block
	Align the text with the right side of the block
	Justify the text so it is spaced evenly in the block
	Change the text direction from horizontal to vertical by clicking the arrow next to the icon
	Resize the text box to fit the contents
	Resize the text to fill the text box

Parent topic: [Getting Started With Label Editor](#)

Designing Labels With Label Editor

Follow the instructions in these sections to design a variety of labels and ribbons.

[Creating a Basic Label in Label Editor](#)

Setting Default Preferences in Label Editor
Working With Blocks in Label Editor
Adding Borders in Label Editor
Inserting Images in Label Editor
Inserting Symbols in Label Editor
Inserting Barcodes in Label Editor
Inserting QR Codes in Label Editor
Inserting Tables in Label Editor
Inserting the Date and Time in Label Editor
Inserting a Background Pattern in Label Editor
Inserting Lines and Shapes in Label Editor
Inserting Text Art in Label Editor
Editing Layout in Label Editor
Editing Text Design in Label Editor

Parent topic: [Using Label Editor for Windows](#)

Creating a Basic Label in Label Editor

You can easily create a label with text and graphics and print it on your label printer.

1. Start Label Editor, select **Horizontal Text**, and click **OK**.

You see a blank label on the main Label Editor screen:

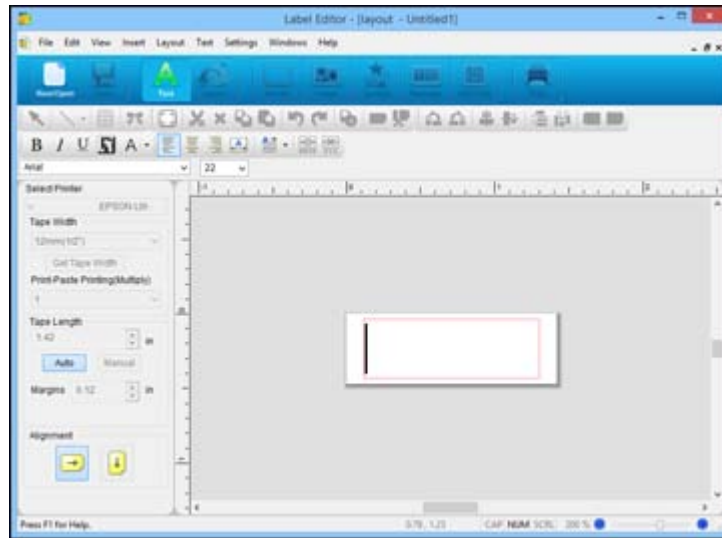

2. Enter text in the label, then click outside the label.
You see your text on the label surrounded by a red line with green handles like this:

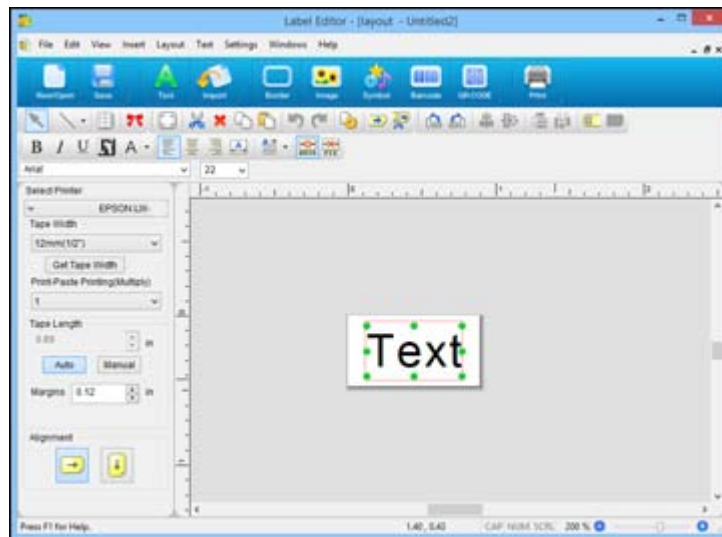

3. To change the font and size, select the text box and select the font name and font size from the selection boxes. (You can use any font installed on your computer.)
4. To save your label, click the **Save** icon, enter a file name, and click **Save**.
5. When you are ready to print, click the **Print** icon.

You see a window like this:

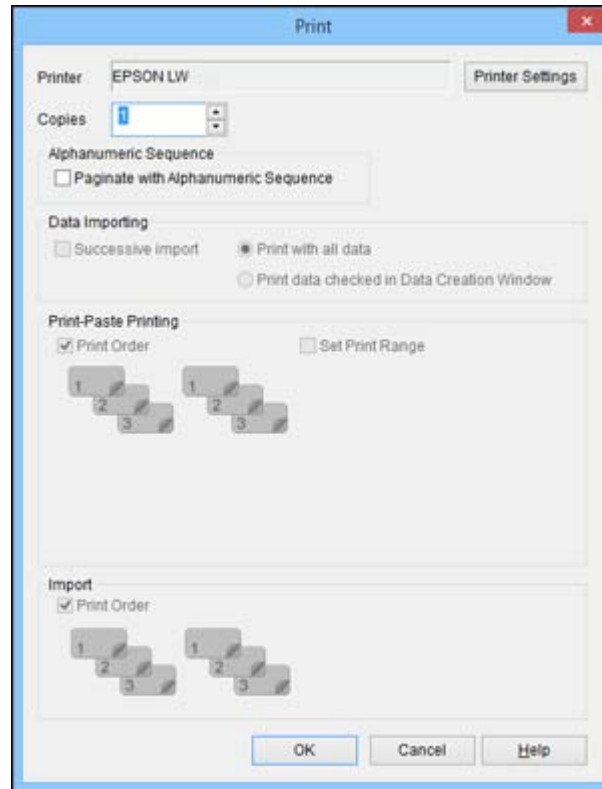

6. Select the number of labels you want in the **Copies** box.
7. Click **OK** to print.

Parent topic: [Designing Labels With Label Editor](#)

Related tasks

[Editing Layout in Label Editor](#)

Editing Text Design in Label Editor

Setting Default Preferences in Label Editor

You can define default settings for the Label Editor screen, text formatting and printing options, and other features.

1. Open the **Settings** menu and select **Preferences**.

You see a window like this:

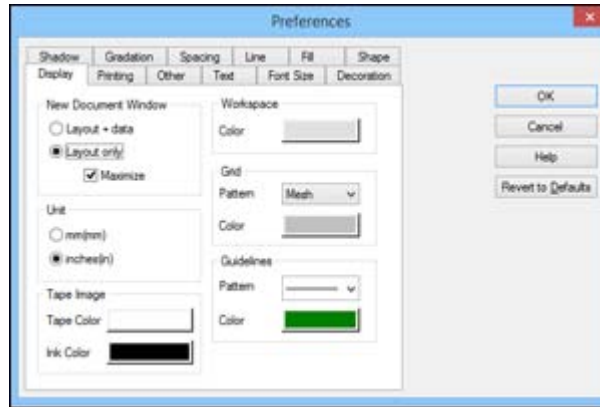

2. Select any of the tabs to display the available options.
3. Select the options you want to use as default settings.
4. To select colors, click the **Color** bar and select from the color chart that appears.
5. When you finish selecting default preferences, click **OK**.

Note: Some settings take effect immediately, some are applied to the next object you create, and others are applied the next time you start Label Editor.

Parent topic: [Designing Labels With Label Editor](#)

Working With Blocks in Label Editor

Every element that you can add to a label is a block. You can format individual blocks of text or other elements such as graphic symbols, dates, and tables.

1. To add a text block to a label, click the **Text** icon.
2. Begin typing anywhere on the workspace.

Your text appears as you type it in.

3. To select the text block you have typed, click outside the text.
Green handles appear around the text block:

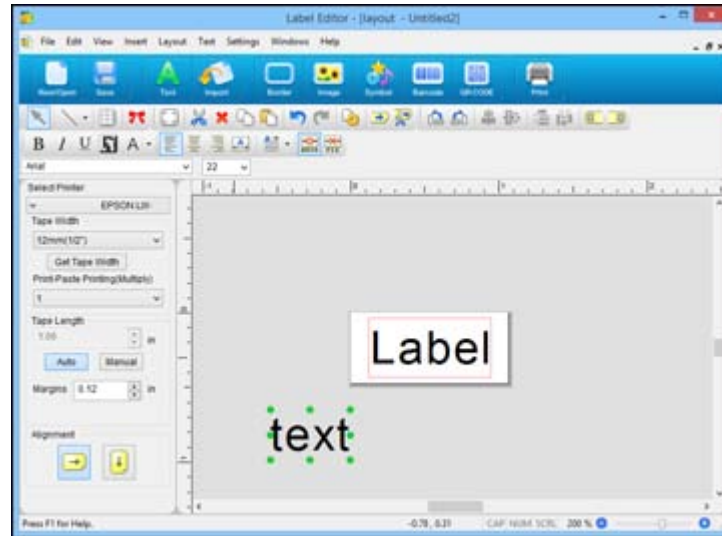

4. Do any of the following:
 - To move the block, simply click and drag it as desired. You can add multiple blocks to a label by dragging them to the right of an existing block on the label area. The label automatically expands to accommodate the new block.
 - To add text to an existing text block, click the **Text** icon, click within the block, and type in the text.
 - To format the text block, click the block to select it and use any of the tools on the text toolbar or the font selection boxes. You can also click the  Properties icon to open a window with formatting options.
 - To resize the text block, click the block to display the green handles. Click and drag one of the handles on the left or right side to the size you want.

Parent topic: [Designing Labels With Label Editor](#)

Related tasks

[Editing Layout in Label Editor](#)

Adding Borders in Label Editor

You can select from a variety of borders for your labels and ribbons.

1. Enter the text for your label.
2. Click the **Border** icon.

You see this window:

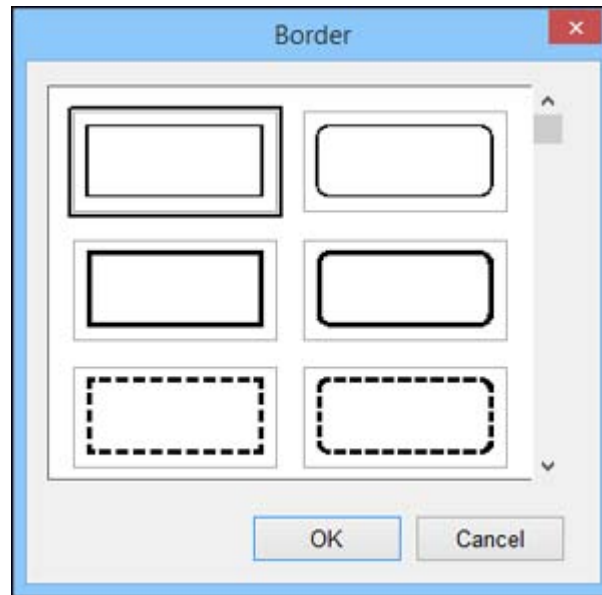

3. Select the border you want and click **OK**.
The border appears on your label.
4. Do the following to adjust the size of the border and position of the text, if necessary:
 - To make the border wider, click and drag on the right side of the border. The white label area expands as you drag the border.
 - To adjust the position of the text, click and drag the text block.
5. When you are finished, click **OK**.

Parent topic: [Designing Labels With Label Editor](#)

Related tasks

[Working With Blocks in Label Editor](#)

Inserting Images in Label Editor

You can add your own logos, photos, or graphics to your labels and ribbons.

1. Click the **Image** icon.
2. Locate and select the file you want to use on your computer and click **Open**.

You see an outline of your image block.

Note: Color photos or other images appear in black and white only.

3. Drag the block where you want the image to appear, and click the block to display it on your label.
4. Adjust the size and position of the image and text.
5. To adjust the image format if necessary, double-click the image.

You see a window like this:

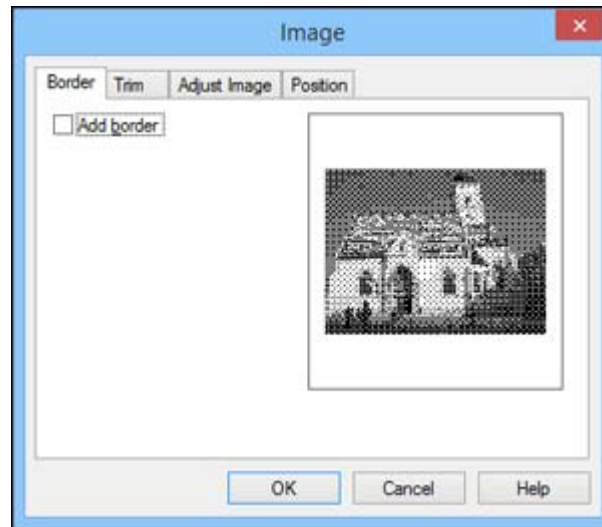

6. Select any of the tabs to display the available options.
7. Select the options you want.

8. When you are finished, click **OK**.

Parent topic: [Designing Labels With Label Editor](#)

Related tasks

[Working With Blocks in Label Editor](#)

Inserting Symbols in Label Editor

You can select from a variety of ready-made graphic symbols to use in your labels and ribbons.

1. Click the **Symbol** icon.

You see this window:

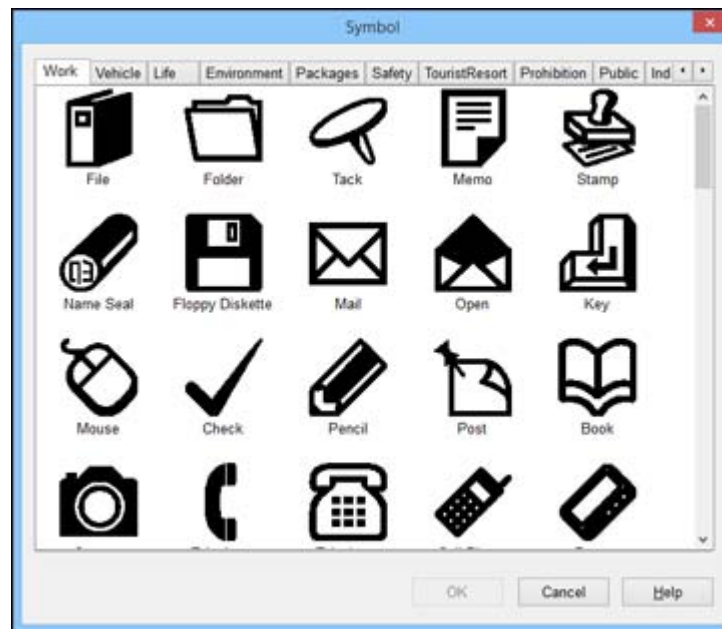

2. Use the arrows at the top of the window to scroll through the available categories. Use the scroll bar on the right to scroll through the available symbols in each category.

3. Select the symbol you want and click **OK**.

You see the outline of the symbol block on the screen.

4. Drag the block where you want it to appear on your label, and click the block to display the symbol.

5. Adjust the size and position of the symbol and text.
6. To adjust the symbol format, if necessary, double-click the symbol.

You see this window:

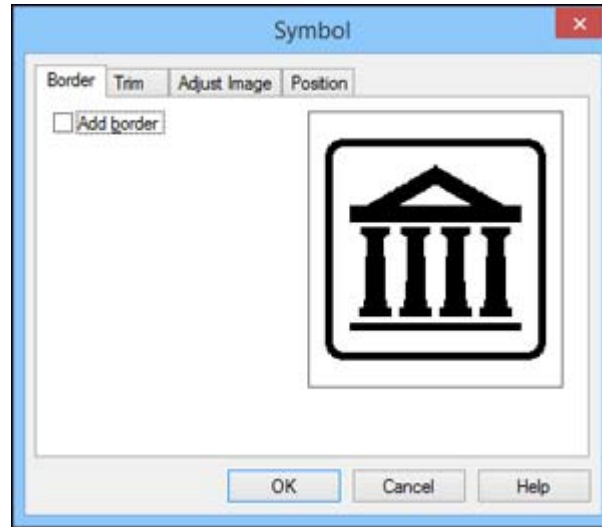

7. Select any of the tabs to display the available options.
8. Select the options you want.
9. When you are finished, click **OK**.

Parent topic: [Designing Labels With Label Editor](#)

Related tasks

[Working With Blocks in Label Editor](#)

Inserting Barcodes in Label Editor

You can create labels with a variety of barcode types for inventory management and asset tagging, such as this one:



1. Click the **Barcode** icon.

You see this window:

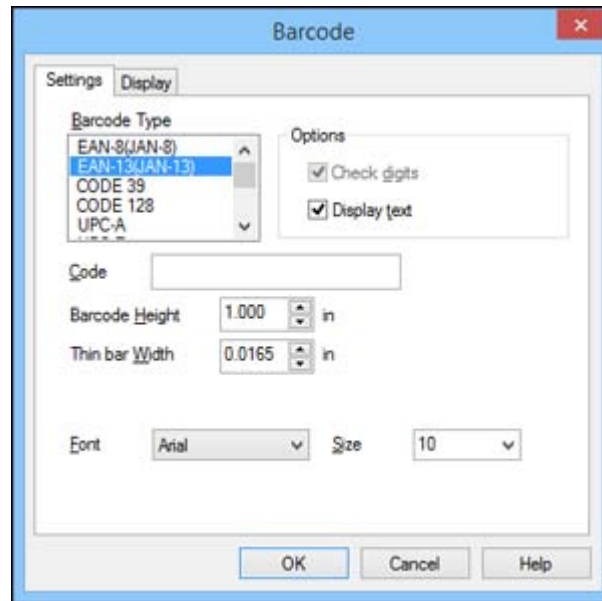

2. Select the type of barcode you want to create.
3. To include the code number beneath the barcode, select the **Display text** checkbox.
4. Enter the code number for your barcode in the **Code** box.
5. Enter the barcode size, positioning, and font information as necessary, and click **OK**.

You see a message about adding margins on the sides of your barcode.

Note: If you do not want to see this message, select the **Display** tab on the Barcode window and uncheck **Message On**.

6. Click **OK**.
You see the outline of your barcode block.
7. Drag the block where you want your barcode to appear, then click the block to display it on your label.

Parent topic: [Designing Labels With Label Editor](#)

Related tasks

[Working With Blocks in Label Editor](#)

Inserting QR Codes in Label Editor

You can create labels with a QR code for many purposes, such as linking to URLs, file storage services, or social media applications. One-inch (24 mm) wide black-on-white tape is recommended for the fastest QR code recognition.



Note: When embedding content from social media applications, consider your privacy settings. When embedding content from file storage services, check the sharing settings to ensure that other people can view the content.

1. Click the **QR Code** icon.

You see this window:

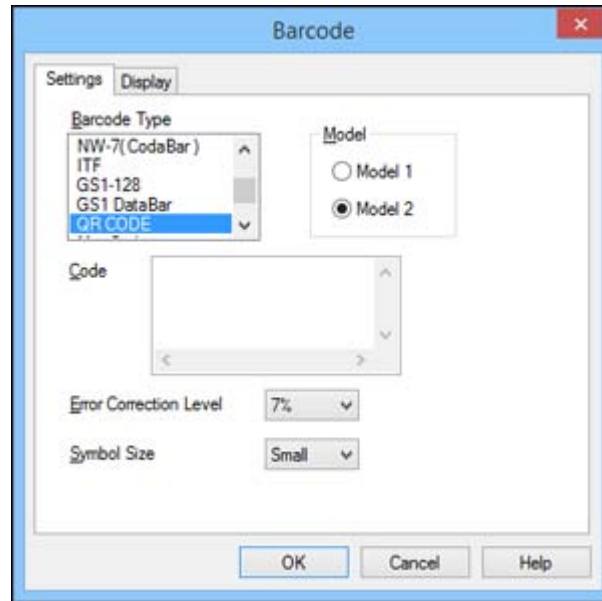

2. Select the type of QR code you want to create.
3. Enter the URL or other text in the Code box.
4. Select the **Error Correction Level** and **Symbol Size** options as necessary, and click **OK**.

Note: **Small** or **Medium** Symbol Size settings are recommended.

You see a message about adding margins around the QR code.

Note: If you do not want to see this message, select the **Display** tab on the Barcode window and deselect the **Message On** checkbox.

5. Click **OK**.
You see the outline of your QR code block.
6. Drag the block where you want your QR code to appear, then click the block to display it on your label.

Parent topic: [Designing Labels With Label Editor](#)

Related tasks

[Working With Blocks in Label Editor](#)

Inserting Tables in Label Editor

You can add customized tables to your labels.

1. Click the  Table icon.

You see this window:

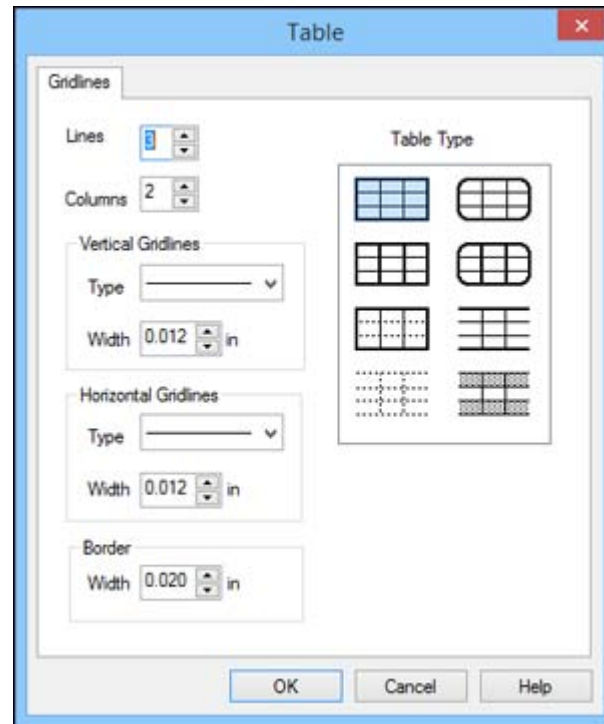

2. Select the table settings you want to use and click **OK**.
The table appears on your label.
3. To resize the table, click and drag one of the green dots to the size you want.
4. To format the table, select it and click the  Properties icon.
You see a window like this:

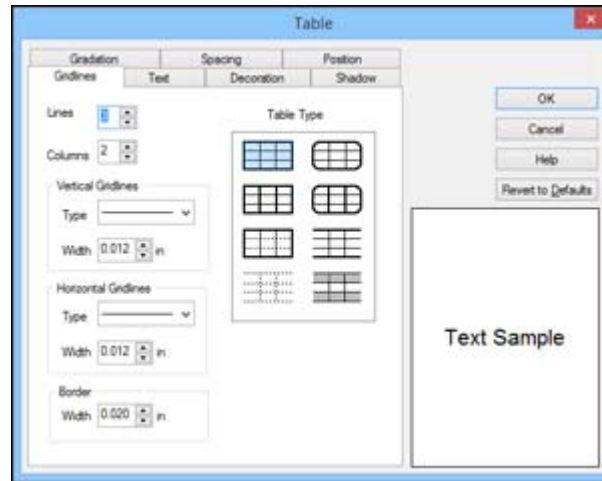

5. Select any of the tabs to display the available options.
6. Select the options you want.
7. When you are finished, click **OK**.

Parent topic: [Designing Labels With Label Editor](#)

Related tasks

[Working With Blocks in Label Editor](#)

Inserting the Date and Time in Label Editor

You can add the date and/or time to your labels and have it automatically updated.

1. Open the **Insert** menu and select **Date and Time**.

You see this window:

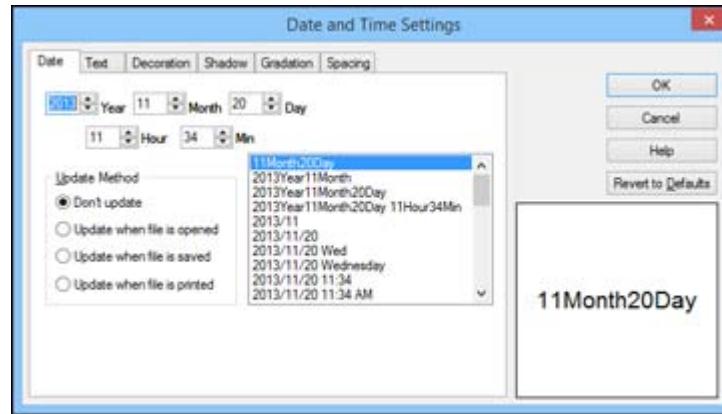

2. Select the date, update method, and display format options you want to use.
3. Select any of the tabs to display additional text formatting options.
4. Select the options you want.
5. Click **OK**.
You see the outline of your date block.
6. Drag the block where you want the date and/or time to appear, then click the block to display it on your label.
7. If you need to adjust the size, click and drag one of the green handles.

Parent topic: [Designing Labels With Label Editor](#)

Related tasks

[Working With Blocks in Label Editor](#)

[Editing Text Design in Label Editor](#)

Inserting a Background Pattern in Label Editor

You can select from several background patterns for your labels and ribbons, or create your own graphic or text background.

Note: All background elements print in light gray.

1. Open the **Insert** menu and select **Background Pattern**.

You see this window:

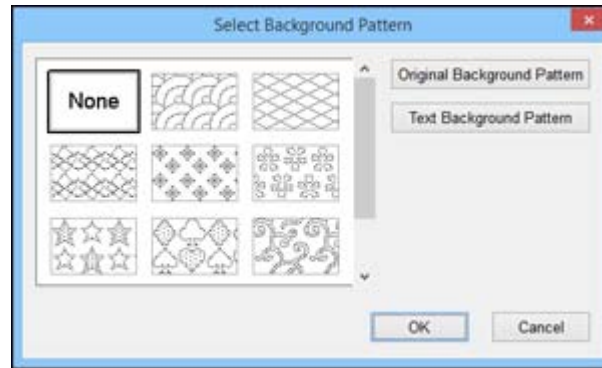

2. Do one of the following:
- Select one of the available background patterns.
 - To create your own pattern, click **Original Background Pattern**, and click **New**. You see this window:

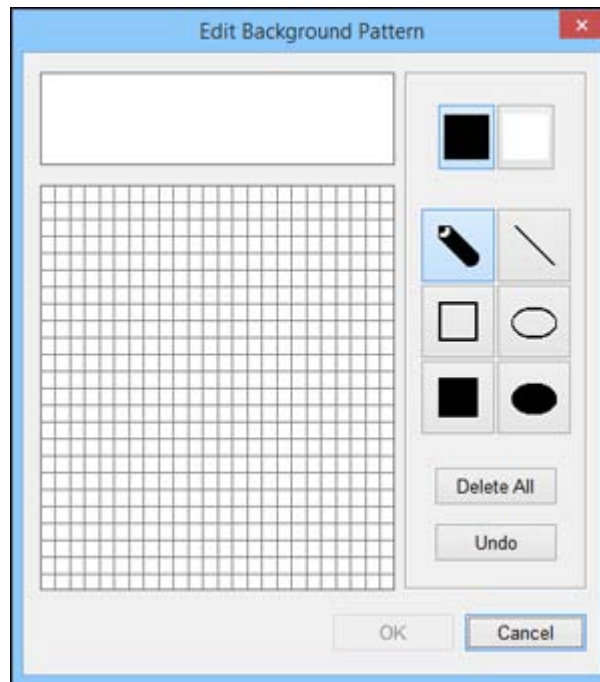

Use the tools to design your pattern and click **OK**. Once you have designed a pattern, Label Editor saves it with the ready-made background patterns you can use it again.

- To create a text background pattern, click **Text Background Pattern**. You see this window:

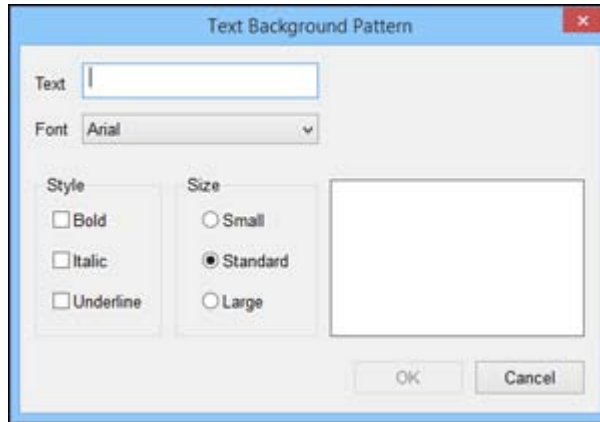

Enter the text for your background, then select the Font, Style, and Size options you want to use.

3. Click **OK**.

You see your background pattern on the Label Editor main screen.

Parent topic: [Designing Labels With Label Editor](#)

Inserting Lines and Shapes in Label Editor

You can add graphics using a variety of lines and shapes to your labels and ribbons.

1. Click the arrow next to the  Straight Line icon.

You see this window:



2. Click the line or shape you want to draw.

Note: If you select the regular polygon shape, you can choose a polygon (and set the number of sides) or a star (and set the number and ratio of points).

3. Click on your label on the screen.
Your cursor turns into a pencil.
4. Drag the pencil to draw your line or shape.

Note: For some lines, you need to click to anchor the line segment, then double-click to finish the line.

5. To format the line or shape, double-click it.

You see a window like this:

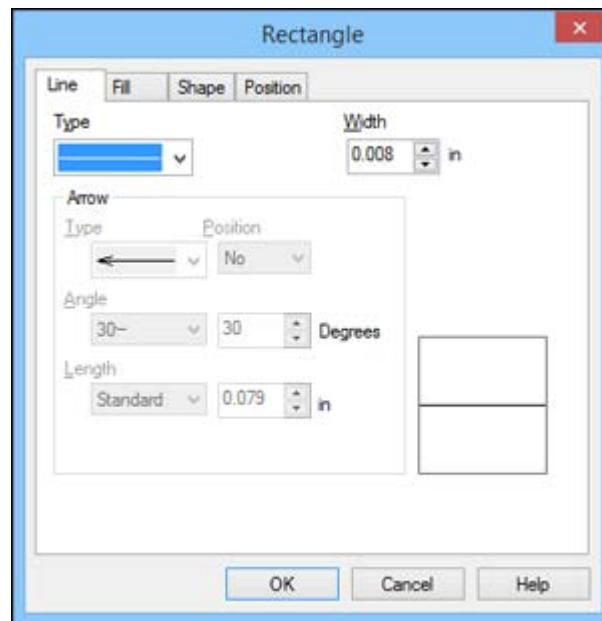

Note: The available options vary depending on the line or shape you select.

6. Select any of the tabs to display the available options.
7. Select the options you want.
8. When you are finished, click **OK**.

Parent topic: [Designing Labels With Label Editor](#)

Related tasks

[Working With Blocks in Label Editor](#)

Inserting Text Art in Label Editor

You can add curves or other special effects to text on your labels and ribbons.

1. Open the **Insert** menu and select **Text Art**.

You see this window:

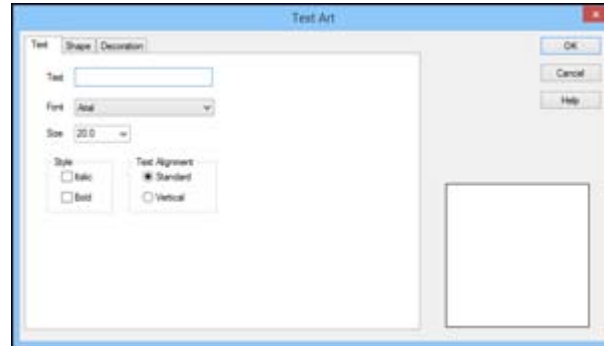

2. Enter the text for the art, then select the Font, Size, Style, and Text Alignment options you want to use.
3. Click the **Shape** tab.

You see this window:

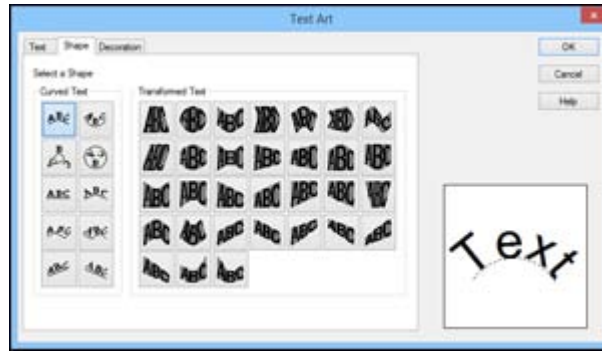

4. Select the curve and transformation options you want to use.
You see a preview of your text art in the window.
5. Click the **Decoration** tab.
6. Select any Fill, Border, and Reverse settings you want to use.
7. Click **OK**.
You see the outline of your text art block.
8. Drag the block where you want the text art to appear, then click the block to display it on your label.

Parent topic: [Designing Labels With Label Editor](#)

Related tasks

[Working With Blocks in Label Editor](#)

Editing Layout in Label Editor

You can rearrange and adjust the layout of the blocks of text and other elements on your labels.

1. To edit the layout of a block, click the  Edit block icon, and click the block on the Label Editor main screen.

Note: To select more than one block, press and hold the **Shift** key on your computer keyboard while you click the blocks (or choose **Select All** from the Edit menu).

You see green handles around the selected block.

2. Open the **Layout** menu.

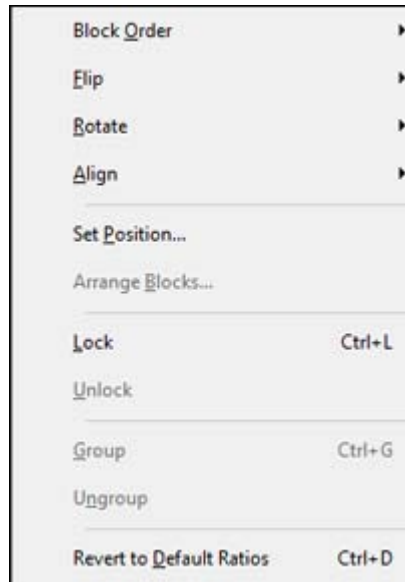

3. Do any of the following.

- To reposition overlapping blocks, click **Block Order** and select any of the available options.
- To flip a block horizontally or vertically, click **Flip** and select one of the options.
- To rotate a block, click **Rotate** and select one of the options.
- To align one or more blocks, click **Align** and select one of the options.
- To reposition a block interactively, click **Set Position**, select one of the options, click **OK**, and click on the label where you want to position the block.
- To reposition multiple blocks interactively, click **Arrange Blocks**, select one of the options, click **OK**, and click one of the blocks.
- To restore the original aspect ratio of an image, click **Revert to Default Ratios**.

Note: You can also use the icons on the Layout toolbar to perform many of the same functions.

Parent topic: [Designing Labels With Label Editor](#)

Related tasks

[Working With Blocks in Label Editor](#)

Editing Text Design in Label Editor

You can use the Text Settings window to apply more text formatting options to your label than those available in the Text toolbar or Text menu.

1. Click a text block on the Label Editor main screen to select it.

You see green handles around the selected block.

2. Click the  Properties icon.

You see this window:

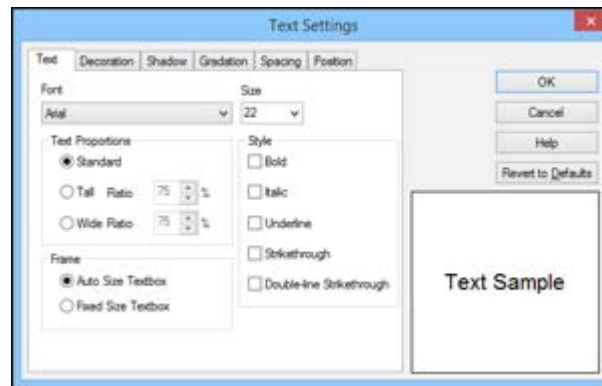

3. Select any of the tabs to display the available options.

4. Select the options you want.

You see a preview of the text in the window.

5. When you finish selecting text settings, click **OK**.

Parent topic: [Designing Labels With Label Editor](#)

Creating Special Format Labels Using Label Editor

Follow the instructions in these sections to create special format labels using Label Editor.

[Creating Labels from Imported Data in Label Editor](#)

[Creating Ribbons With Repeated Patterns in Label Editor](#)

[Creating Equipment Management Labels in Label Editor](#)

[Using the Label Editor Catalog](#)

Creating Numbered Label Sequences in Label Editor

Parent topic: [Using Label Editor for Windows](#)

Creating Labels from Imported Data in Label Editor

You can create a series of labels using the data from one or more spreadsheet columns. This lets you quickly create address labels from your entire address book, for example.

The following file formats are supported: .csv, .txt, .xls, .xlsx, and .xlsm.

Note: To use .xls, .xlsx, or .xlsm file formats, you must have Microsoft Excel installed on your computer.

1. On the New/Open screen, select **Import(Horizontal text)** and click **OK**.

You see this window:

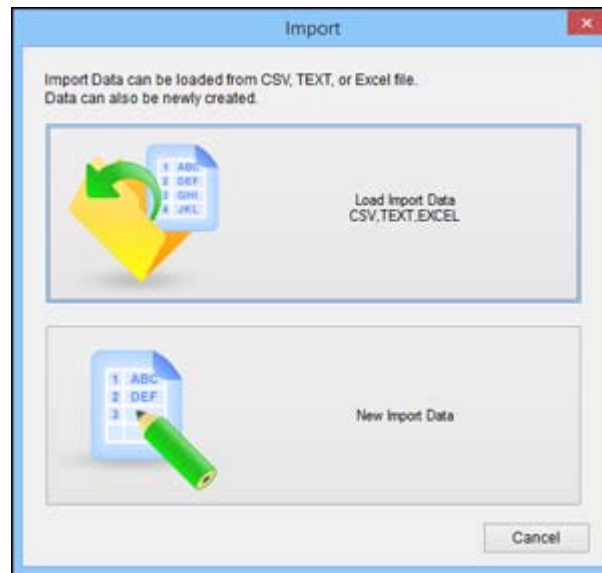

2. Click **Load Import Data**, select the file you want to import, and click **Open**.
3. Select **Overwrite Current Data** and choose a data sheet, if necessary.

You see a Layout window and a Data window side by side:

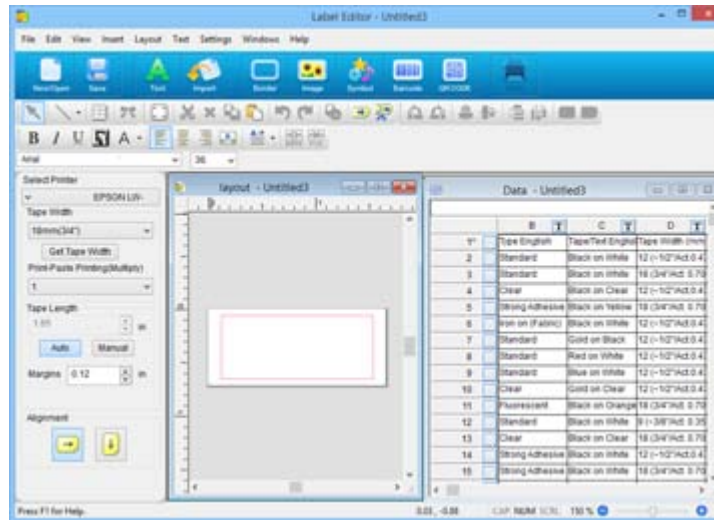

4. Click the **Import** icon.
You see a window like this:

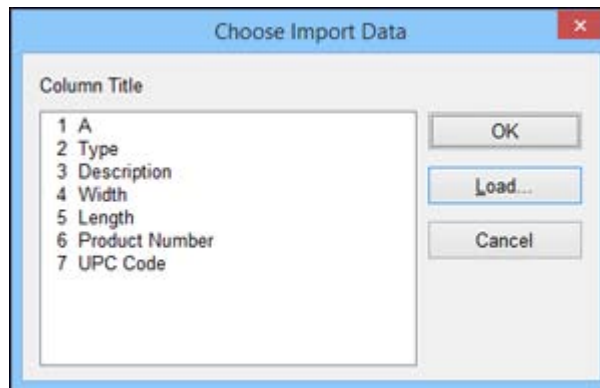

5. Select one of the columns that you want to import and click **OK**.
You see the outline of an import frame.
6. Drag the frame where you want the data to appear on your label.

You see the data from the current row on the label layout:

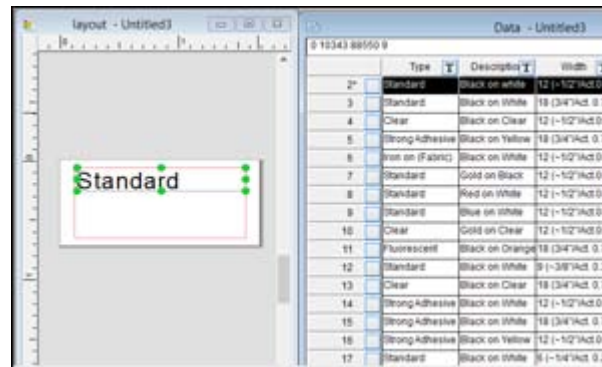

7. Repeat steps 5 and 6 until all the data you want to import appears on the label.
8. Adjust the size and position of the import frames as necessary.
9. To save your label project, click the **Save** icon, enter a file name, and click **Save**.
10. To select specific rows to print, click the checkbox to the right of the row number in the Data window. A green check mark appears next to the row number.

Note: You can select a row in the Data window and see a preview of your label in the Layout window.

11. Click the **Print** icon.

You see a window like this:

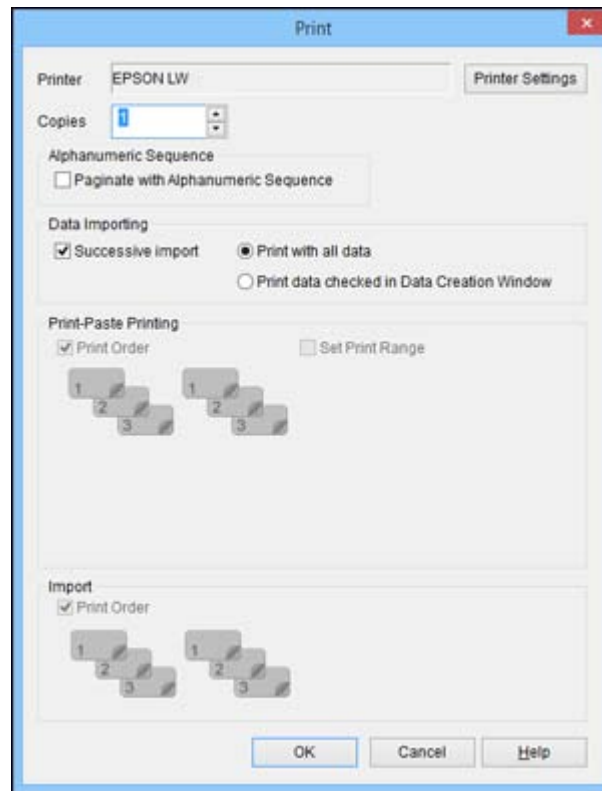

12. Select the number of labels you want in the **Copies** box.
13. Select the options you want in the **Data Importing** section.
14. Click **OK** to print your labels.

Parent topic: [Creating Special Format Labels Using Label Editor](#)

Related tasks

[Creating Equipment Management Labels in Label Editor](#)

[Printing Labels in Label Editor](#)

[Print-Paste Printing in Label Editor](#)

Creating Ribbons With Repeated Patterns in Label Editor

You can easily create ribbons with repeated patterns of text and graphics. Load ribbon tape in your label printer before you print.

Note: For best results, turn off the auto cutter and use scissors to cut the ribbon.

1. Enter the text for your label. You can use normal text or text art for curved or transformed text.
2. Select the font and size for the text.
3. Add symbols, images, or a border, if desired.
4. Click the  Ribbon icon.

You see this window:

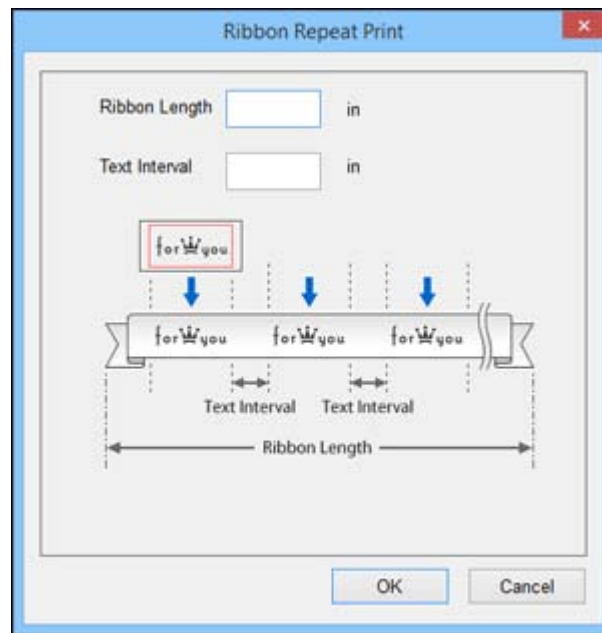

5. Enter the length of the ribbon and interval between each repeated block.
6. Click **OK**.

You see a preview of your ribbon design.

Parent topic: [Creating Special Format Labels Using Label Editor](#)

Related tasks

[Inserting Images in Label Editor](#)

[Inserting Symbols in Label Editor](#)

[Adding Borders in Label Editor](#)

[Printing Labels in Label Editor](#)

Creating Equipment Management Labels in Label Editor

You can select from several templates for equipment management labels and modify the templates as necessary. You can create a series of equipment management labels by entering the text manually or by importing it from a file.

1. On the New/Open screen, select **Equipment Management** and click **OK**.

You see this window:



The screenshot shows a dialog box titled "Equipment Management" with a close button (X) in the top right corner. The dialog contains three previewable label templates, each with a scroll bar on the right side. The first template is a 2x5 grid with the following data:

Asset class	Fixed asset
Equipment name	Laptop
Admin no.	ABC0123
Date	04/01/20XX
Section	Information System Department

The second template is a 3x2 grid with the following data:

Asset name	Laptop
Admin no.	ABC0123
Date	04/01/20XX

The third template is a 4x2 grid with the following data:

Asset number	ABC0123
Asset name	Laptop
Date	04/01/20XX
	XX Co., Ltd.

At the bottom of the dialog box, there are two buttons: "OK" and "Cancel".

2. Scroll down to view the available templates, select the one you want to use, and click **OK**.
You see a window like this:

The screenshot shows a window titled "Equipment Management" with a "Data Entry" tab selected. On the left, there is a preview of a label with a QR code. On the right, there are six input fields labeled 1 through 6: 1. Company name, 2. Asset name, 3. Admin no., 4. Date, 5. Section, and 6. QR CODE. Below the fields, there is a "Recommended Tape Width" dropdown set to "24mm(*)" and a "Data Importing (for Multiple Labels)" section with a "Reference" button. At the bottom right are "OK" and "Cancel" buttons.

3. Do one of the following:
 - Select **Data Entry**, enter the text for each field, and click **OK**.
 - Select **Data Importing (for Multiple Labels)**, click **Reference**, and select the data file you want to use. Follow the instructions for importing data.

You see a screen like this:

The screenshot shows two windows. The left window is a layout editor showing a label with a QR code and the following data: Asset name: Epson, Admin no.: 34237, Date: 1/25/14, Section: Information. The right window is a data editor titled "Data - Untitled5" showing a table with the following data:

	Company na	Asset nam	Ad
1*	Epson	PC	34237
2			

4. Do any of the following:
 - To edit the default field labels, double-click each text block and enter the text you want.
 - To format the text you entered, double-click it on the layout window.
 - To create additional labels using the same template, enter the text in the Data window. After you complete each row, a blank row appears below it.
5. To save your label project, click the **Save** icon, enter a file name, and click **Save**.
6. Click the **Print** icon.
7. Select the number of copies and any other settings you want.
8. Click **OK** to print your labels.

Parent topic: [Creating Special Format Labels Using Label Editor](#)

Related tasks

[Creating Labels from Imported Data in Label Editor](#)

[Printing Labels in Label Editor](#)

[Print-Paste Printing in Label Editor](#)

Using the Label Editor Catalog

Label Editor includes a catalog containing a variety of ready-made labels. You can print the existing labels or customize them as necessary.

1. From the New/Open screen, select **Label Catalog**, and click **OK**.

You see this window:

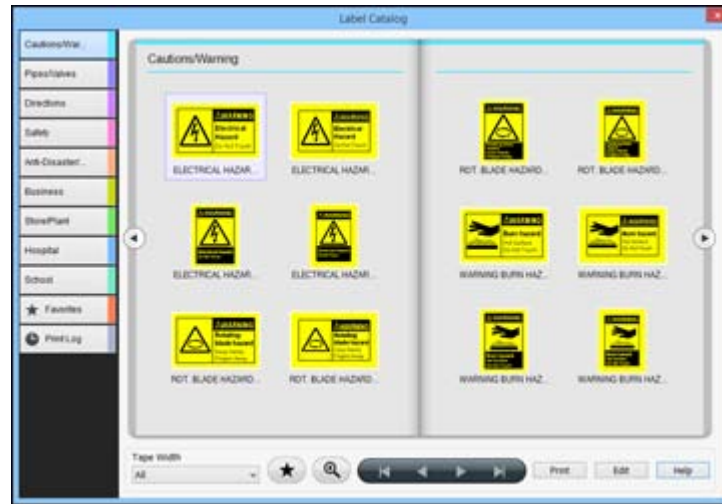

2. Select a category on the left, then scroll through the label images to select the one you want.

Note: To limit your selection to the tape width you are using, click the arrow under **Tape Width** and select the width.

3. To edit a selected label, click **Edit**.
You see the label on the Label Editor screen. You can use any of the available editing tools to edit the label blocks.
4. To print a selected label, click **Print**.
5. Select the number of copies and any other settings you want.
6. Click **OK** to print.

Parent topic: [Creating Special Format Labels Using Label Editor](#)

Related tasks

[Editing Layout in Label Editor](#)

[Editing Text Design in Label Editor](#)

[Printing Labels in Label Editor](#)

Creating Numbered Label Sequences in Label Editor

You can create copies of a label that are automatically numbered in sequence using numerals or letters of the alphabet.

1. Create the text for your label.
2. Open the **Insert** menu and select **Alphanumeric Sequence**.

You see this window:

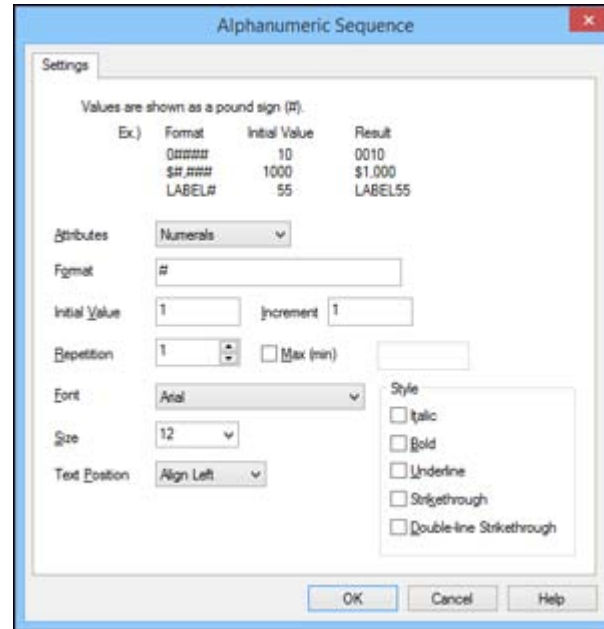

3. Select **Numerals** or **Alphabetic Value** as the Attributes option.
4. Enter one or more **#** symbols as the Format option to represent the number of digits you want in your sequence.
5. For **Initial Value**, enter the starting number or letter for your sequence.
6. For **Increment**, enter the value to add for each subsequent label. To create a decreasing sequence, enter a minus number.
7. For **Repetition**, enter the number of times to repeat an item in the sequence. To specify a maximum or minimum value for your sequence, select the **Max (min)** checkbox and enter the value.

8. Select the Font, Size, Text Position, and Style options as necessary for the sequence.
9. Click **OK**.
You see the outline of your sequence number block on the Label Editor main screen.
10. Drag the sequence block where you want the number to appear, then click to display it on your label.
11. If you need to adjust the size, click and drag one of the green handles.
12. To save your label project, click the **Save** icon, enter a file name, and click **Save**.
13. Click the **Print** icon.

You see a window like this:

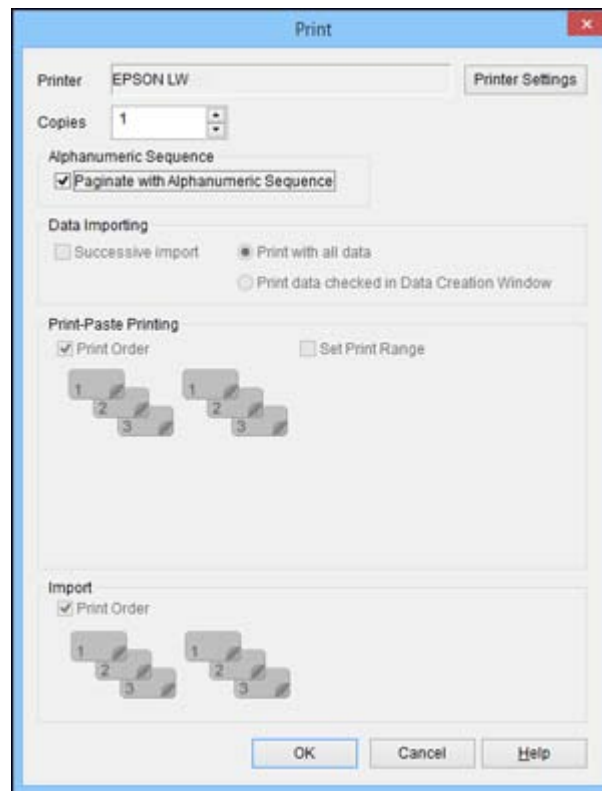

14. Select the number of copies of each label you want to print.

15. Select the **Paginate with Alphanumeric Sequence** checkbox.
16. Click **OK** to print.

Parent topic: [Creating Special Format Labels Using Label Editor](#)

Printing Labels With Label Editor

Follow the instructions in these sections to print using Label Editor.

[Printing Labels in Label Editor](#)

[Label Editor Printer Settings](#)

[Print-Paste Printing in Label Editor](#)

Parent topic: [Using Label Editor for Windows](#)

Printing Labels in Label Editor

When you have finished designing a label, you are ready to print.

1. Click the **Print** icon.

You see a window like this:

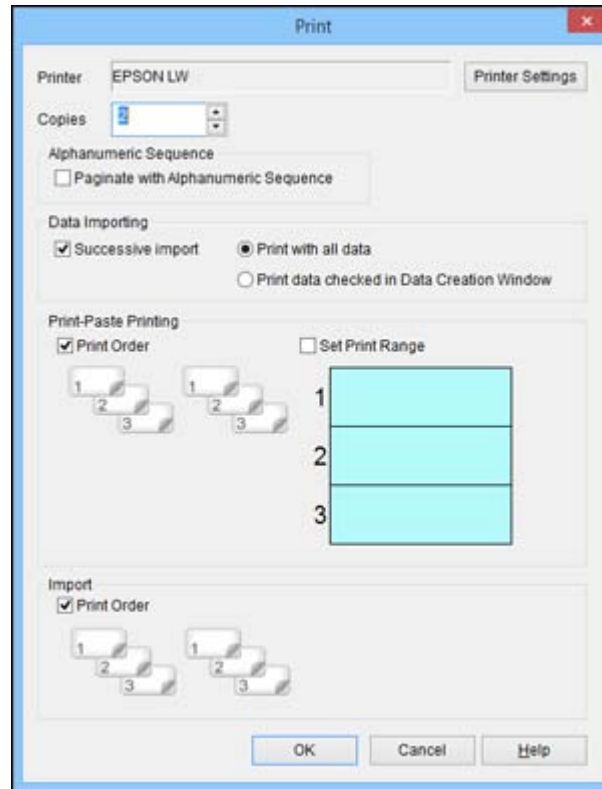

2. Select the number of copies.
3. If you are printing a numbered sequence of labels, select the **Paginate with Alphanumeric Sequence** checkbox.
4. If you are printing a series of labels with imported data, select the options you want in the Data Importing section.
5. To turn off collation when printing multiple copies of labels with imported data, select the **Print Order** checkbox in the Import section.
6. If you are using Print-Paste Printing, select the **Set Print Range** checkbox, then select the sections you want to print.
7. To turn off collation when printing multiple copies with Print-Paste Printing, select the **Print Order** checkbox in the Print-Paste Printing section.

8. To select additional printing options, click **Printer Settings**.

You see this window:

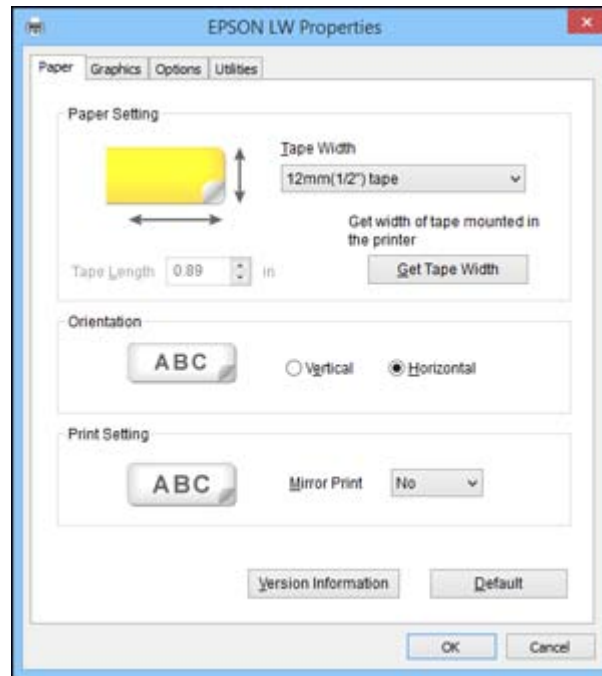

9. Select any of the tabs to display the available options.
10. Select the options you want.
11. Click **OK** to close the window.
12. Click **OK** to print.

Parent topic: [Printing Labels With Label Editor](#)

Related references

[Label Editor Printer Settings](#)

Label Editor Printer Settings

The Printer Settings options let you adjust many label features as you print, including the orientation of text and mirror printing.

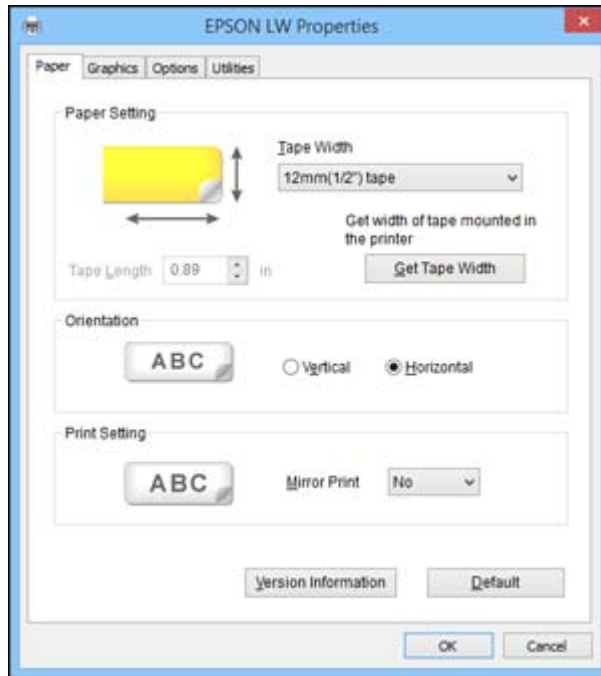

Setting	Options	Description
Paper tab		
Tape Width	Various widths available	Sets the width of the loaded tape Get Tape Width: detects the width of the loaded tape automatically
Orientation	Vertical Horizontal	Sets the orientation of the label text
Print Setting	Mirror Print	Select Yes for mirror-image printing on clear labels for use on transparent surfaces
Graphics tab		

Setting	Options	Description
Resolution	180 dpi	Sets the print quality automatically
Dithering	Rough Fine Line Art BW	Sets the method for printing imported images BW : lets you set the threshold for turning grayscale images into black and white
Concentration	-3 to +3	Decreases or increases the print density
Options tab		
Cut Setting	Cut each label Cut after job Don't cut	Sets how the label is cut Cut each label : cuts each label as it is printed Cut after job : prints multiple labels in a print job without cutting Don't cut : prints all labels without cutting, so you can cut them manually
View Setting	Display tape width confirmation message Print Preview	Displays selected information before printing
Unit	mm(mm) inches(in)	Selects the units of measurement used in Label Editor
Utilities tab		
Feed and Cut	Select to feed, or feed and cut labels, or to restart the printer driver	
Feed		
Printer Drivers Restart		

Parent topic: [Printing Labels With Label Editor](#)

Print-Paste Printing in Label Editor

You can create labels from imported data and select individual data fields or columns to print on separate labels. For example, instead of including the item name, code, and price on one label, you can create three separate labels, one for each item. This is called print-paste printing in Label Editor.

1. Create or open a label project with imported data.
You see a label with the layout you have selected.
2. Select the layout window.
3. Click the arrow under **Print-Paste Printing(Multiply)** on the left side of the screen.
4. Select the number of labels you want to create from each existing label.

You see an expanded area on the layout window, like this:

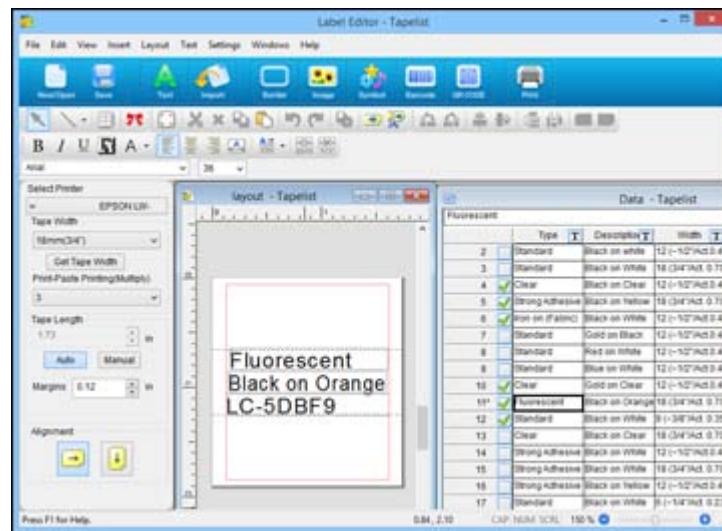

5. Drag the import frames from the original label to the additional labels in the display window.
You see your individual print-paste labels, like this:

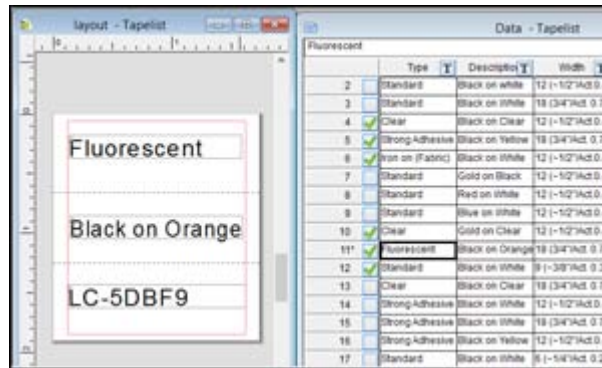

- Click the **Print** icon.
You see a window like this:

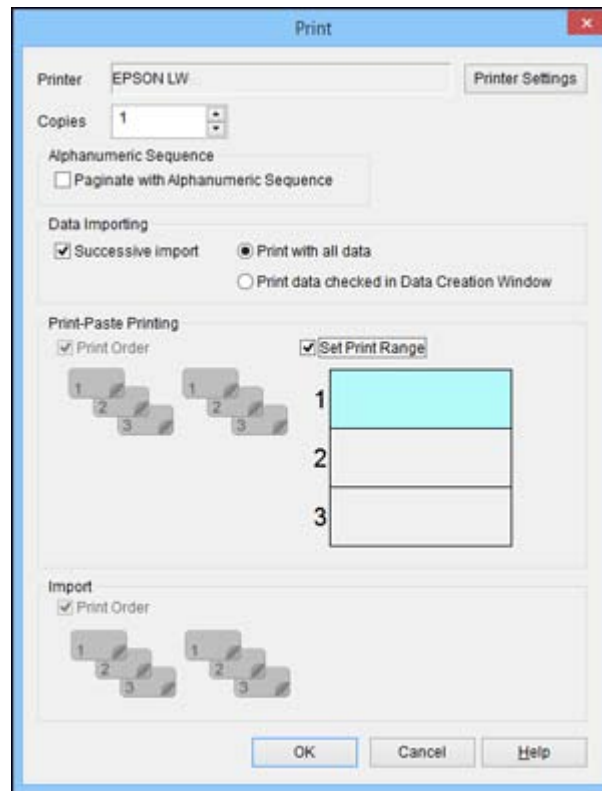

7. Select the **Set Print Range** checkbox in the Print-Paste Printing section.
8. Select the individual labels you want to print.
9. To turn off collation when printing multiple copies, select the **Print Order** checkbox in the Print-Paste Printing section.
10. Select additional print options as necessary.
11. Click **OK** to print.

Parent topic: [Printing Labels With Label Editor](#)

Related references

[Label Editor Printer Settings](#)

Using Label Editor Lite for OS X

The Label Editor Lite software makes it easy to create labels using a Mac, as described in these sections.

[Getting Started With Label Editor Lite](#)

[Designing Labels With Label Editor Lite](#)

[Feeding and Cutting the Tape in Label Editor Lite](#)

[Printing Labels With Label Editor Lite](#)

Parent topic: [Using the Printer With Your Computer](#)

Getting Started With Label Editor Lite

Follow the instructions in these sections to get started using Label Editor Lite for OS X.

[Installing Label Editor Lite](#)

[Starting Label Editor Lite](#)

[Label Editor Lite Main Window](#)

Parent topic: [Using Label Editor Lite for OS X](#)

Installing Label Editor Lite

Install the Label Editor Lite software from the App Store. If you can not access the App Store, you can download the software from Epson's support website.

1. Open the App Store.
2. Enter **Epson Label Editor Lite** in the search field and press the  button.
3. Click **Epson Label Editor Lite** in the list of apps.
4. Click **Free**.

The button name changes to **Install App**.

5. Click **Install App**.
6. Download the printer driver from Epson's support website and install it. Visit the driver download site ([U.S. downloads](#) or [Canadian downloads](#)).

Label Editor Lite installs on your Mac.

Parent topic: [Getting Started With Label Editor Lite](#)

Starting Label Editor Lite

After you have installed the Label Editor Lite software and connected the printer to your computer, you can start using Label Editor Lite.

1. Choose **Applications > Label Editor Lite**.

You see the main screen:

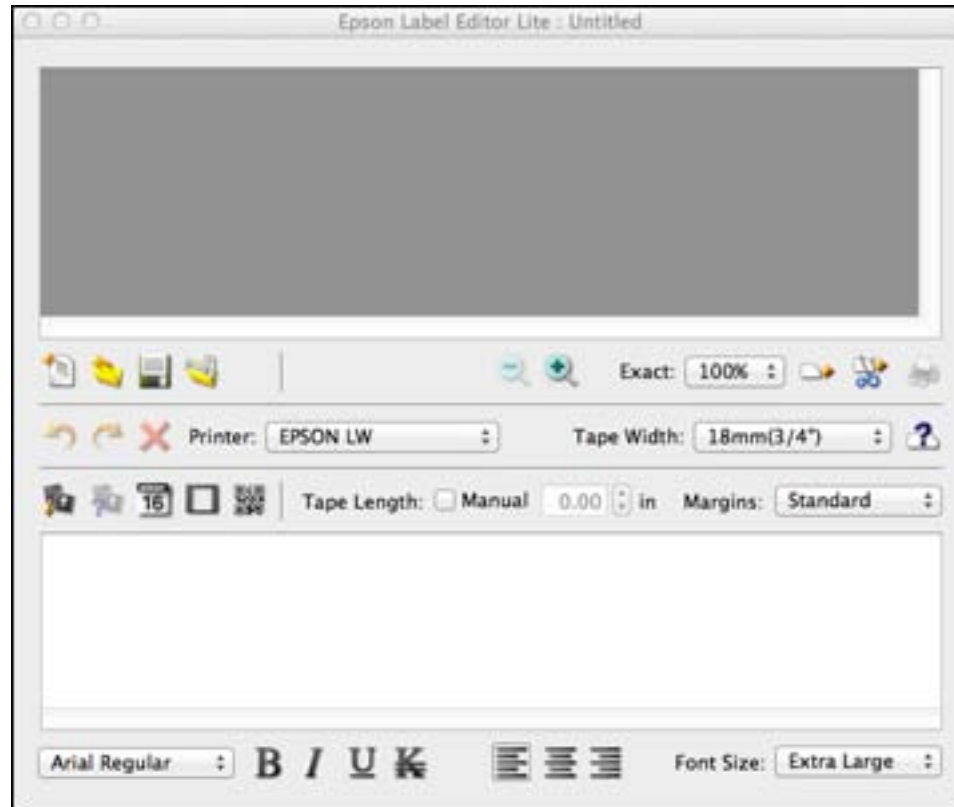

Parent topic: [Getting Started With Label Editor Lite](#)

Related tasks

[Connecting the Printer to Your Computer](#)

Label Editor Lite Main Window

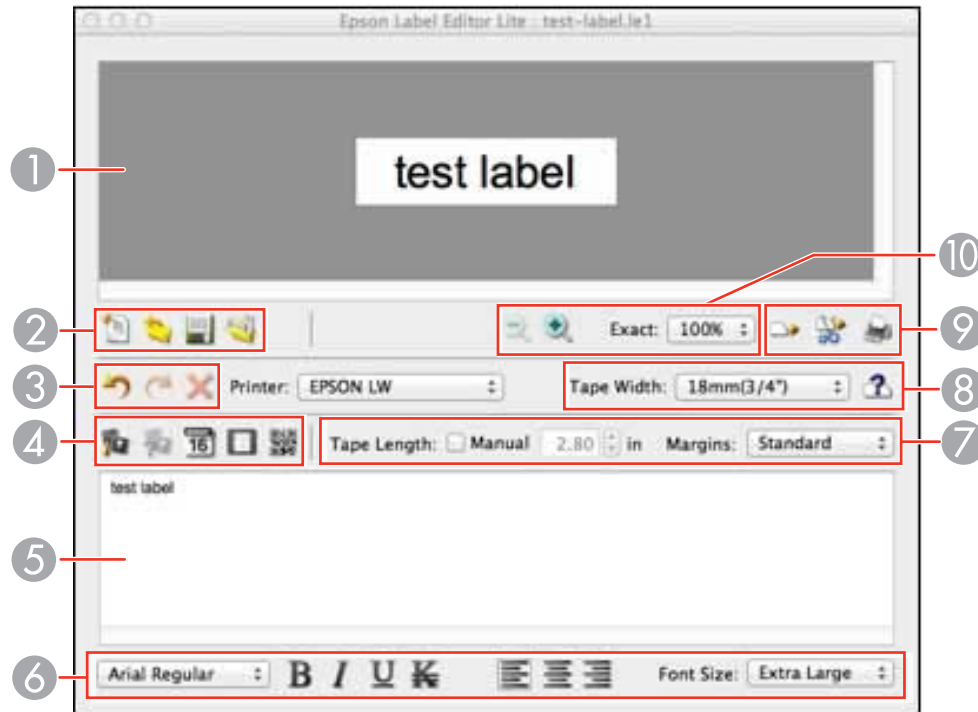

- 1 Label preview area
- 2 File area
- 3 History area
- 4 Insert area
- 5 Text editing area
- 6 Font settings list
- 7 Tape length settings area
- 8 Tape width settings area
- 9 Printing area
- 10 Zoom area

Parent topic: [Getting Started With Label Editor Lite](#)

Designing Labels With Label Editor Lite

Follow the instructions in these sections to design a variety of label and ribbon types.

[Setting Default Preferences in Label Editor Lite](#)

[Creating a Basic Label in Label Editor Lite](#)

[Formatting Text in Label Editor Lite](#)

[Inserting Images in Label Editor Lite](#)

[Inserting the Date and Time in Label Editor Lite](#)

[Adding Borders in Label Editor Lite](#)

[Inserting QR Codes in Label Editor Lite](#)

[Using the Label Editor Lite Wizard](#)

Parent topic: [Using Label Editor Lite for OS X](#)

Setting Default Preferences in Label Editor Lite

You can define default settings for the Label Editor Lite screen, text formatting and printing options, and other features.

1. Open the **Epson Label Editor Lite** menu and select **Preferences**.

You see a window like this:

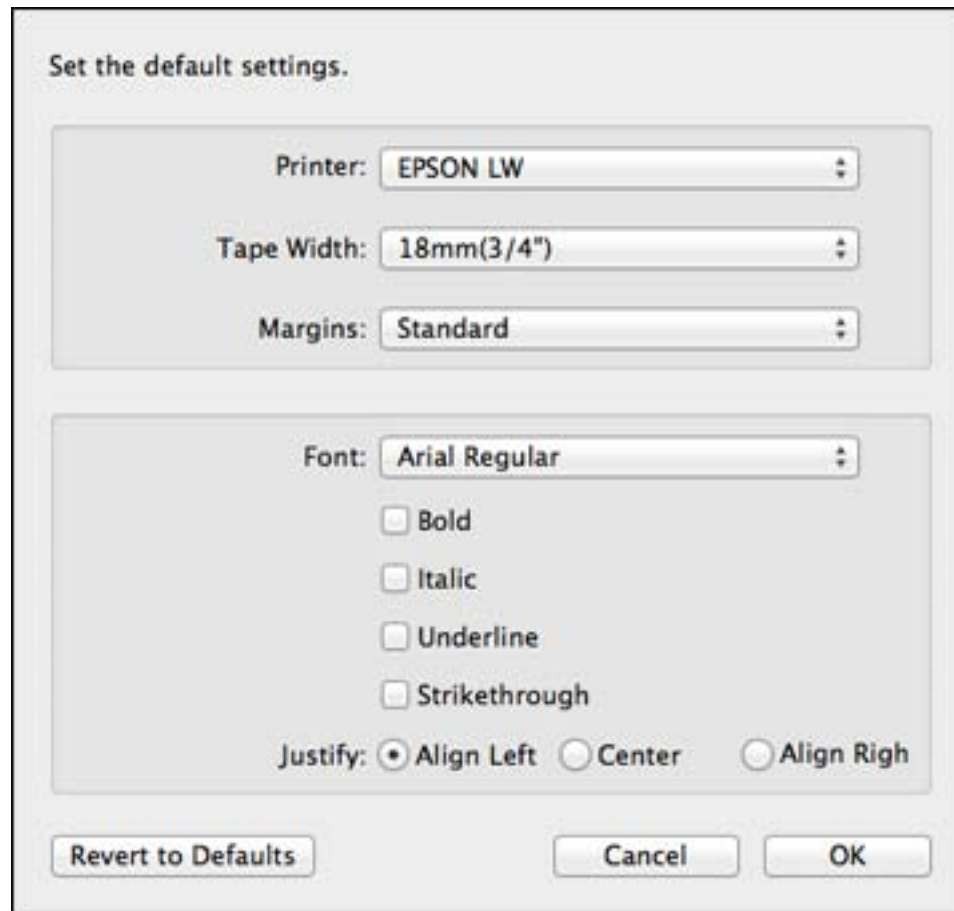

2. Select the options you want to use as default settings.

Note: The settings are applied to the next object you create.

3. Click **OK**.
4. Click **OK** again.

You return to the main window.

Parent topic: [Designing Labels With Label Editor Lite](#)

Creating a Basic Label in Label Editor Lite



You can easily create a label with text and graphics and print it on your label printer.

1. Start Label Editor Lite.

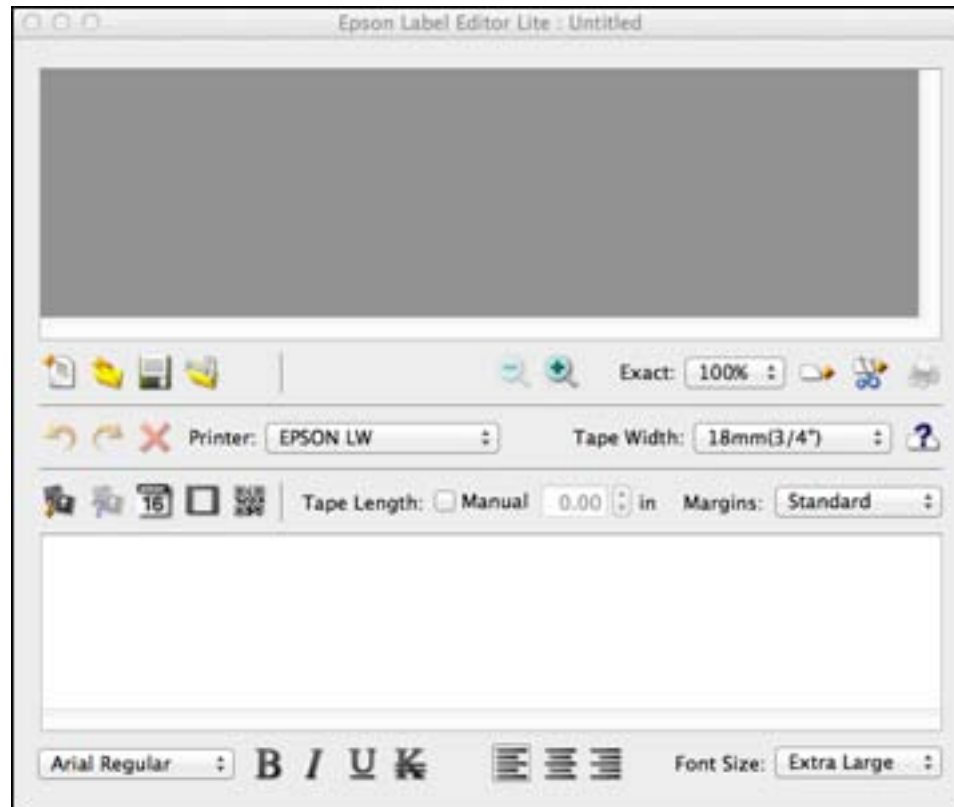
You see the main Label Editor Lite screen:



2. Select the printer and tape width,
3. Enter the text for your label in the text field.
The text appears in the text editing area and the label preview area.
4. To change the font and size, select the text box, and select the font name and font size from the selection boxes. (You can use any font installed on your computer.)

5. To save your label, click the  save icon, enter the file name, select any tags, and click **Save**.
6. When you are ready to print, click the  print icon.

You see a window like this:

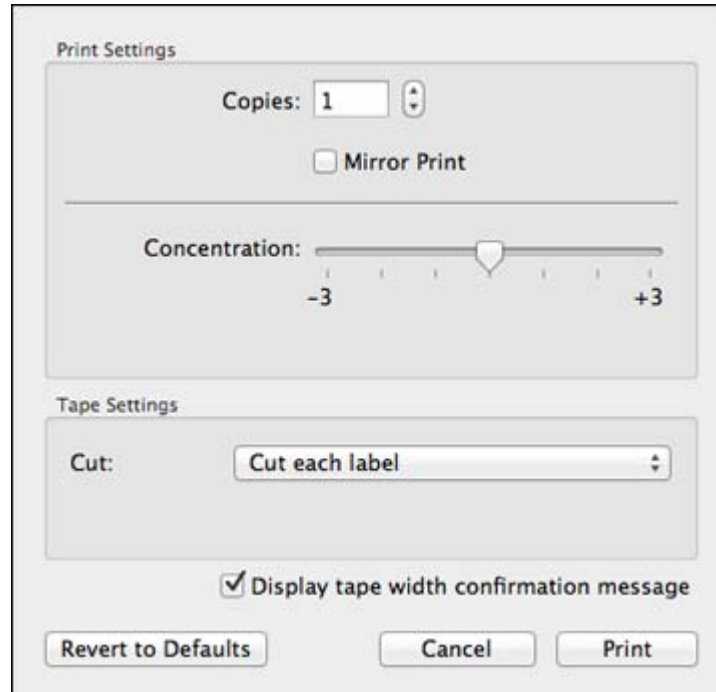



7. Select the number of labels you want in the **Copies** box.
8. Click **Print**.
You see a tape width confirmation message.
9. Click **OK** to print.

Parent topic: [Designing Labels With Label Editor Lite](#)

Formatting Text in Label Editor Lite

You can use the Text toolbar or the Text menu to format the alignment or basic style of your text.

1. Enter text or click the text in a label.

2. Do any of the following:
 - Change the font by selecting it in the font list
 - Emphasize the text using the **B** bold, *I* italic, U underline, or ~~K~~ strikethrough buttons or menu options
 - Change the text justification using the  left justify,  center, or  right justify buttons or menu options
 - Change the font size in the Font Size list

The text is updated as you select font options.

Parent topic: [Designing Labels With Label Editor Lite](#)

Inserting Images in Label Editor Lite

You can add your own logos, photos, or graphics to your labels and ribbons.

1. Click the  insert image icon.
2. Locate and select the file you want to use on your computer and click **Insert**.

Note: Color photos or other images appear in black and white only.

The image appears in the label.

3. Click the  image properties icon.

You see this window:

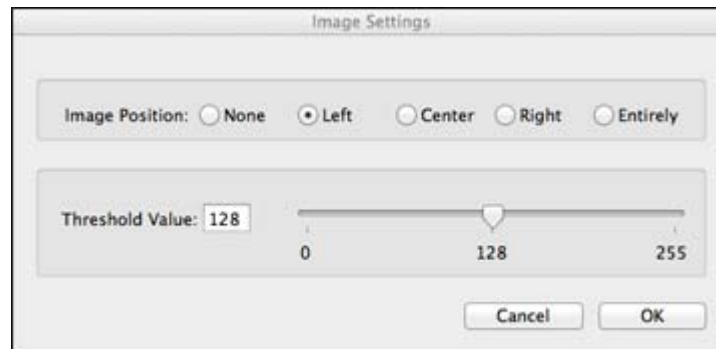

4. Select the Image Position and Threshold Value options you want to use.

5. Click **OK**.

Parent topic: [Designing Labels With Label Editor Lite](#)

Inserting the Date and Time in Label Editor Lite

You can add the date and/or time to your labels and have it automatically updated.

1. Click the  date icon.

You see this window:

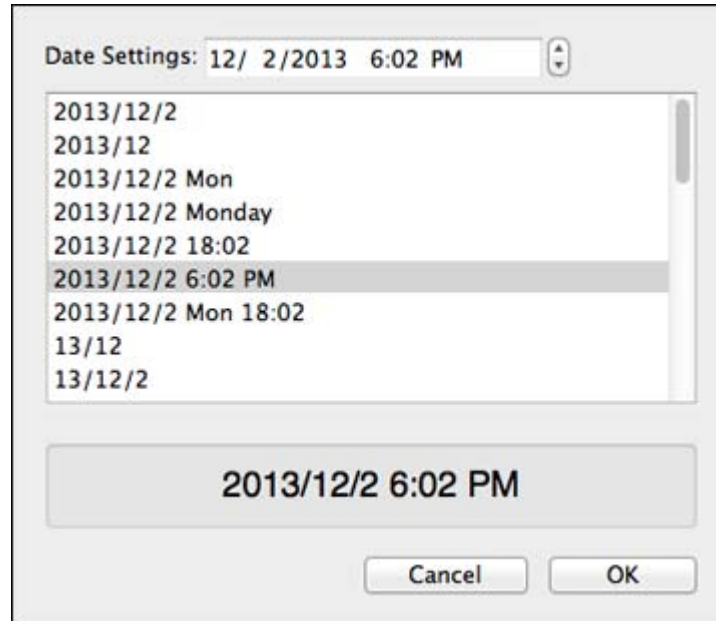

2. Select the date format option you want to use.
3. Click **OK**.

The date appears in the label.

Parent topic: [Designing Labels With Label Editor Lite](#)

Adding Borders in Label Editor Lite

You can select from a variety of borders for your labels and ribbons.

1. Enter text in a label.

2. Click the  border icon.

You see this window:

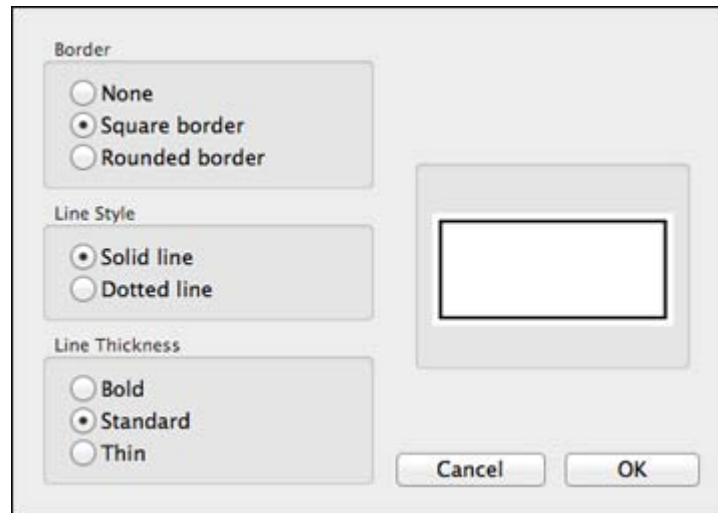

3. Select the Border, Line Style, and Line Thickness options you want to use.
4. Click **OK**.

The border appears in the label.

Parent topic: [Designing Labels With Label Editor Lite](#)

Inserting QR Codes in Label Editor Lite

You can create labels with a QR code for many purposes, such as linking to URLs, file storage services, or social media applications. One-inch (24 mm) wide black-on-white tape is recommended for the fastest QR code recognition.



Note: When embedding content from social media applications, consider your privacy settings. When embedding content from file storage services, check the sharing settings to ensure that other people can view the content.

1. Click the  QR code icon.

You see this window:

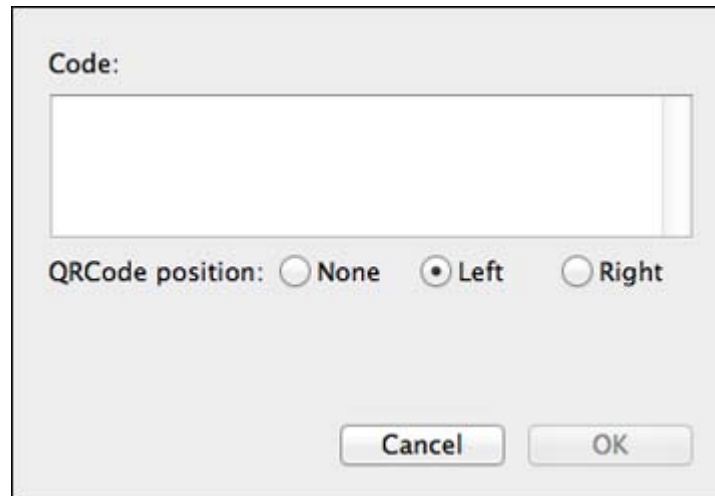

The screenshot shows a dialog box with a light gray background. At the top left, the label "Code:" is followed by a large, empty text input field. Below the input field, the text "QRCode position:" is followed by three radio button options: "None", "Left", and "Right". The "Left" option is selected, indicated by a filled circle. At the bottom of the dialog box, there are two buttons: "Cancel" on the left and "OK" on the right.

2. Enter the URL or other text in the Code box.
3. Select the QRCode position option you want to use.
4. Click **OK**.

The QR code appears in the label.

Parent topic: [Designing Labels With Label Editor Lite](#)

Related tasks

[Printing Labels With Label Editor Lite](#)

Using the Label Editor Lite Wizard

You can choose from a variety of templates to help you design your labels and ribbons.

1. Click the  wizard icon.

You see a window like this:

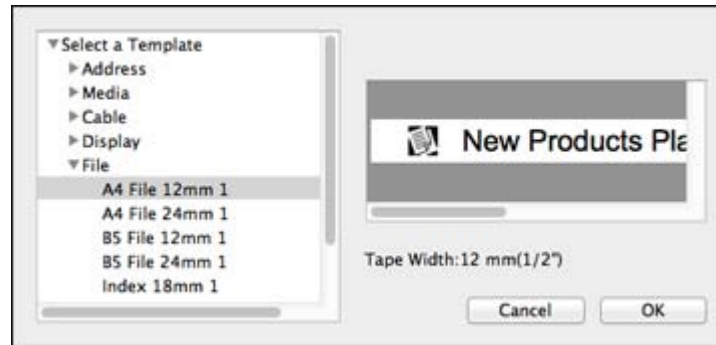

2. Click the arrow to expand the list of template files.

Note: Template previews appear in the template window.

3. Select a template and click **OK**.

The template opens on the Label Editor Lite main screen.

4. Edit the template as you would any other label.

Parent topic: [Designing Labels With Label Editor Lite](#)

Related tasks

[Printing Labels With Label Editor Lite](#)

[Formatting Text in Label Editor Lite](#)

Feeding and Cutting the Tape in Label Editor Lite

You can manually feed the tape or ribbon, or feed and automatically cut it.

- Click the  feed icon.

The printer feeds a short length of tape or ribbon.

- Click the  feed and cut icon.

The printer feeds a short length of tape or ribbon and cuts it.

Parent topic: [Using Label Editor Lite for OS X](#)

Printing Labels With Label Editor Lite

When you have finished designing a label, you are ready to print.

1. Click the  print icon.

You see a window like this:

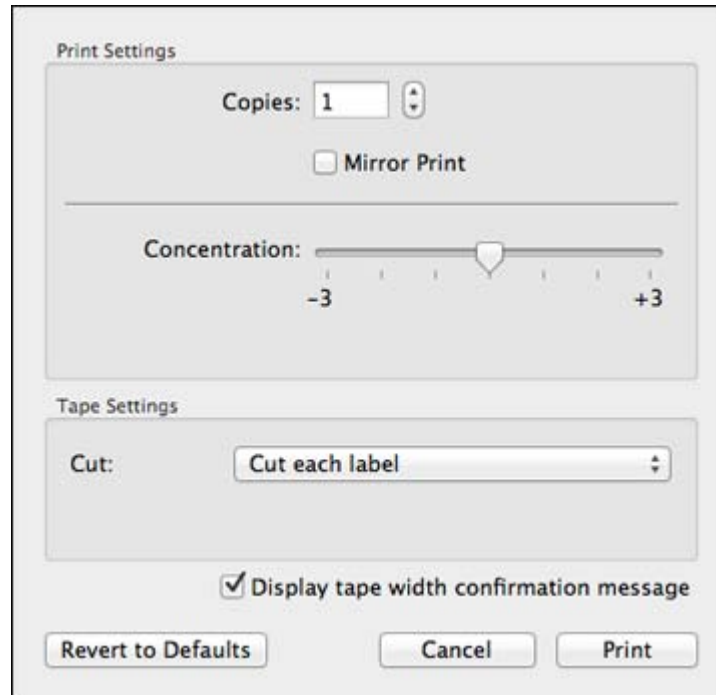

2. Select the number of copies.
3. Select the **Mirror Print** checkbox if you want the label to print on clear tape to be used on a transparent surface.
4. Select the **Concentration** setting to decrease or increase the print density.
5. Select the Cut option you want to use.
6. Click **Print**.

Parent topic: [Using Label Editor Lite for OS X](#)

Applying Your Labels

Follow the instructions in these sections to apply your printed labels.

[Applying Standard Labels](#)

[Iron-on Labels](#)

Applying Standard Labels

Your printed labels are easy to attach to most surfaces.

Caution: Depending on the environment and the surface to which you attach them, labels may peel off or become discolored, and the adhesive may remain on or damage the surface. Epson is not responsible for any damage or loss due to these causes.

Do not attach labels to human bodies or other living things, or to surfaces that you are not authorized to modify.

1. Peel off the backing.

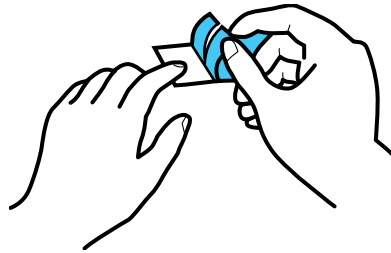

2. Place the label on the desired surface and press it down firmly.

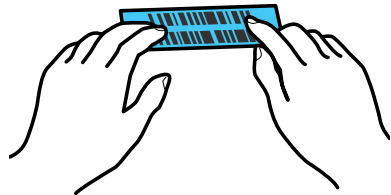

Parent topic: [Applying Your Labels](#)

Iron-on Labels

You can apply iron-on labels to the following types of fabric:

- 100% cotton
- 100% linen
- 100% polyester
- Cotton/polyester blends
- Fabrics with a flat, smooth surface

Note: Do not apply iron-on labels to textured fabrics such as terry cloth, corduroy, or flannel; roughly woven fabrics; fabrics with a rough surface such as denim; waterproof fabrics; or fabrics which require a cool iron.

[Applying Iron-on Labels](#)

[Iron-on Label Tips](#)

Parent topic: [Applying Your Labels](#)

Applying Iron-on Labels

Press the entire label firmly and do not use steam or a press cloth.

1. Set your iron to 284–320 °F (140–160 °C), without steam.
2. Make sure the area where you want to apply the label is not wrinkled.
3. Place the label in the desired location with the printed side up.
4. Gently press the iron down on one end of the label to temporarily attach it in place.

5. Press the iron firmly down on the entire label, holding the iron still for about 10 to 15 seconds. Repeat this step 3 or 4 times.

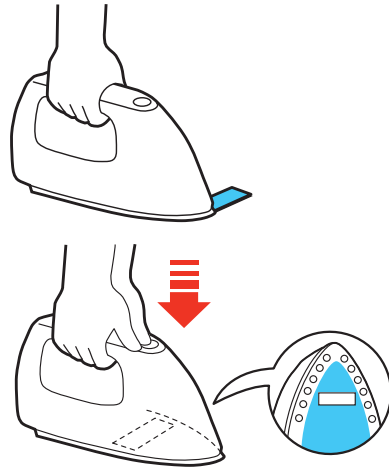

Parent topic: [Iron-on Labels](#)

Iron-on Label Tips

Keep this information in mind when using iron-on labels:

- Labels are made from non-toxic materials; however, attached labels are stiff, and may rub or scratch the skin if direct contact occurs.
- Labels are dry-cleanable and machine washable.
- Keep the label length short (up to about half the width of the iron soleplate). Labels that are too long may be difficult to attach or may look distorted due to the expansion and contraction of the fabric.
- Trimming the corners of the label before attaching it may help prevent it from peeling off the fabric.
- If a label does peel, you can re-apply by ironing; however, it may not adhere as securely to the fabric.
- When applying a label to fabric that may be frequently washed or dry-cleaned, it is recommended that the label be sewn on.
- When using a steam iron, turn the steam off when ironing on the label.
- Once a label is applied, it cannot be easily removed.

- Never clean the labels with chemicals or solvents such as benzine, thinner, or alcohol. Otherwise, the print on the label may become faint or distorted.
- If labels are exposed to direct sunlight for long periods of time, yellowing may occur.
- Iron-on labels do not adhere to non-fabric materials such as paper or leather.
- When using bleach or spot detergent, make sure you test it in advance.

Parent topic: [Iron-on Labels](#)

Cleaning the Printer

Follow the instructions in these sections to clean your label printer.

[Cleaning the Outside of the Printer](#)

[Cleaning the Print Head](#)

Cleaning the Outside of the Printer

Before cleaning the printer, turn off the power and unplug the AC adapter.

- To remove dust or dirt, use a soft, dry, lint-free cloth.
- To remove stubborn dirt, use a soft cloth moistened with water.

Caution: Do not use benzene, paint thinner, alcohol, or other chemicals to clean the printer. Do not use canned air or chemical dusters.

Parent topic: [Cleaning the Printer](#)

Cleaning the Print Head

If streaks or white lines appear on your labels, you can clean the print head.

Caution: Do not use benzene, paint thinner, or other chemicals to clean the printer. Do not use canned air or chemical dusters.

1. Turn off the power and unplug the AC adapter.
2. Lift up the tape cover.
3. Grasp the sides of the tape and lift it out of the printer.

4. Use a dry cotton swab to gently clean the print head as shown.

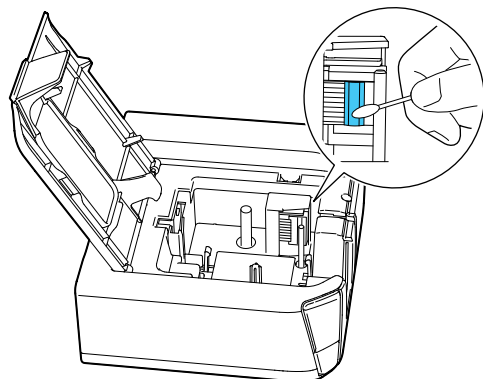

Parent topic: [Cleaning the Printer](#)

Related tasks

[Inserting and Removing Tape Cartridges](#)

Solving Problems

Check the solutions in this section if you have any problems using the printer.

[Checking for Software Updates](#)

[Product Error Messages](#)

[Solutions to Problems Pairing with Bluetooth](#)

[Solutions When the Printer Does Not Print](#)

[Solutions to Computer Printing Problems](#)

[Solutions When Print Quality Is Poor](#)

[Solutions to Tape Cutting Problems](#)

[Solutions to Problems With Saved Labels](#)

[Solutions to Problems Attaching Labels](#)

[Solutions to Problems With Iron-on Labels](#)

[Where to Get Help](#)

Checking for Software Updates

Periodically, it's a good idea to check Epson's support website for free updates to your product software. Visit the driver download site ([U.S. downloads](#) or [Canadian downloads](#)).

Parent topic: [Solving Problems](#)

Product Error Messages

You can often diagnose problems with your label printer by checking the status lights.

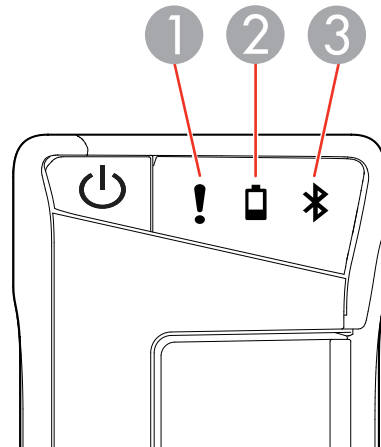

- 1 Error light
- 2 Battery light
- 3 Bluetooth light

Light	Condition	Printer status
Bluetooth	Plusing	Bluetooth enabled
	On	Bluetooth connection established
	Flashing quickly	Performing operations such as printing or label cutting
	Flashing once every 5 seconds	Bluetooth disabled
battery	On	Low batteries; replace batteries soon
	Flashing quickly	Replace batteries
! error	Flashing quickly	Printer error; check the message displayed on the connected computer or mobile device for error information

Parent topic: [Solving Problems](#)

Related references

[Where to Get Help](#)

Related tasks

[Inserting and Removing Tape Cartridges](#)

[Installing Batteries](#)

Solutions to Problems Pairing with Bluetooth

If you connected your mobile device to your printer using Bluetooth, try these solutions:

- Make sure the mobile device's Bluetooth is turned on.
- Check to see if the printer's Bluetooth light is pulsing. If not, enable Bluetooth on the printer and try pairing with the printer again.
- Check if the printer is communicating with another mobile device. The printer can only communicate with one device at a time.
- If the printer is connected to a computer with a USB cable, it cannot communicate using Bluetooth. Disconnect the USB cable and try pairing the printer again.
- Check your mobile device for any messages.

Parent topic: [Solving Problems](#)

Related tasks

[Installing iLabel](#)

Related topics

[Connecting the Label Printer to Your Mobile Device](#)

Solutions When the Printer Does Not Print

If labels do not print or a print job stops, try these solutions:

- Check for messages on the computer or mobile device's display.
- Check that the cables are connected properly or the Bluetooth connection is active.
- Make sure the printer is selected in the software.
- Make sure you have entered text for your label.
- Replace the tape cartridge if necessary. Make sure the cartridge is correctly inserted.
- Replace the batteries or connect the AC adapter.

Parent topic: [Solving Problems](#)

Related tasks[Installing Batteries](#)[Inserting and Removing Tape Cartridges](#)[Connecting the AC Adapter](#)[Turning the Printer On and Off](#)

Solutions to Computer Printing Problems

If you are having trouble printing from your computer, try these solutions:

- Check for messages on the computer screen.
- Make sure the printer is connected to your computer.
- Make sure the printer driver is installed and the computer has been restarted after installation.
- Make sure the correct printer is selected in your software, and the printer is not set as offline.
- Make sure graphics are within the margins of the label.

Parent topic: [Solving Problems](#)

Related tasks[Connecting the Printer to Your Computer](#)[Installing Label Editor](#)[Installing Label Editor Lite](#)

Solutions When Print Quality Is Poor

If you see lines or broken text on your labels or ribbons, try these solutions:

- Clean the print head.
- Make sure there is no slack in the tape.
- Try adjusting the print density or concentration.
- Try using a different font for your label or ribbon design.

Parent topic: [Solving Problems](#)

Related references[Label Editor Printer Settings](#)**Related tasks**[Cleaning the Print Head](#)

[Creating a Basic Label in Label Editor Lite](#)

[Creating a Basic Label in Label Editor](#)

[Printing Labels in Label Editor](#)

[Printing Labels With Label Editor Lite](#)

Solutions to Tape Cutting Problems

If the printer does not cut after printing, try these solutions:

- Make sure the cut setting is selected in the software.
- If you are printing from your computer, make sure the cut setting option is set.
- If the cutter blade is dull, contact Epson for technical support.

Parent topic: [Solving Problems](#)

Related references

[Where to Get Help](#)

[Label Editor Printer Settings](#)

Related tasks

[Feeding and Cutting the Tape in Label Editor Lite](#)

[Printing Labels With Label Editor Lite](#)

[Printing Labels in Label Editor](#)

Solutions to Problems With Saved Labels

If you cannot find a saved label or ribbon design, try these solutions:

- Make sure you have not accidentally deleted the label or ribbon design.
- If you are using the mobile app, check the History list to see if the label has been automatically saved.

Parent topic: [Solving Problems](#)

Solutions to Problems Attaching Labels

If you are having trouble attaching a label, try these solutions:

- Make sure you peel off the backing paper before attaching the label.
- Make sure the surface you are attaching the label to is clean and dry. Labels may not adhere to some materials, rough or uneven surfaces, or surfaces subject to extreme environmental conditions, such as high humidity or heat.

Parent topic: [Solving Problems](#)

Related tasks

[Applying Standard Labels](#)

Solutions to Problems With Iron-on Labels

If you are having trouble applying an iron-on label, try these solutions:

- If labels curl after ironing or fall off after washing, try raising the iron temperature (within the suggested temperature range).
- Make sure you press the iron down on the entire label.
- Try holding the iron down for 15 to 20 seconds.
- Try trimming the corners of the label.
- If an item needs frequent washing, you may need to sew on the label instead of ironing it.

Parent topic: [Solving Problems](#)

Related references

[Iron-on Label Tips](#)

Related tasks

[Applying Iron-on Labels](#)

Where to Get Help

If you need to contact Epson for technical support services, use the following support options.

Internet Support

Visit Epson's support website at epson.com/support (U.S.) or epson.ca/support (Canada) for solutions to common problems. You can download drivers and documentation, get FAQs and troubleshooting advice, or e-mail Epson with your questions.

Speak to a Support Representative

Before you call Epson for support, please have the following information ready:

- Product name
- Product serial number (located on a label on the product)
- Proof of purchase (such as a store receipt) and date of purchase
- Computer configuration

- Description of the problem

Then call:

- U.S.: (562) 276-7245, 6 AM to 8 PM, Pacific Time, Monday through Friday, and 7 AM to 4 PM, Pacific Time, Saturday
- Canada: (905) 709-2567, 6 AM to 8 PM, Pacific Time, Monday through Friday, and 7 AM to 4 PM, Pacific Time, Saturday

Days and hours of support are subject to change without notice. Toll or long distance charges may apply.

Purchase Supplies and Accessories

Epson offers a wide array of tapes and ribbons for multiple uses. You can purchase tape cartridges and accessories at epson.com/labelworks (U.S.) or epson.ca/labelworks (Canada). You can also purchase supplies from an Epson authorized reseller. To find the nearest one, call 800-GO-EPSON (800-463-7766).

Parent topic: [Solving Problems](#)

Technical Specifications

These sections list the technical specifications of your printer.

- [Label Editor Software System Requirements](#)
- [Label Editor Lite Software System Requirements](#)
- [Mobile Device System Requirements](#)
- [Label Printer Specifications](#)
- [Label Printer Power Supply Specifications](#)

Label Editor Software System Requirements

To use the Label Editor software, your computer should meet these requirements:

Operating system	Windows 8.x (32- and 64-bit) Windows 7 (32- and 64-bit) SP1 Windows Vista (32- and 64-bit) SP2 Windows XP (32- and 64-bit) SP3
Hard drive space	About 300MB
Display	1024 x 768 (XGA) or higher resolution
Interface	USB 1.1 Full-speed

Note: Visit Epson's support website at epson.com/support (U.S.) or epson.ca/support (Canada) for the latest in compatibility and drivers for your product.

Parent topic: [Technical Specifications](#)

Label Editor Lite Software System Requirements

To use the Label Editor Lite software, your Mac should meet these requirements:

Operating system	OS X 10.9 OS X 10.8.x OS X 10.7.x OS X 10.6.x
Hard drive space	About 40MB
Display	1024 x 768 (XGA) or higher resolution
Interface	USB 1.1 Full-speed

Note: Visit Epson's support website at epson.com/support (U.S.) or epson.ca/support (Canada) for the latest in compatibility and drivers for your product.

Parent topic: [Technical Specifications](#)

Mobile Device System Requirements

To use the iLabel app, your mobile device should meet the following requirements:

Operating system	Android iOS
Communication method	Conforms to Bluetooth Specification Version 2.1 + EDR
Output	Bluetooth Specification Version Power Class 2
Maximum communication distance	About 32 feet (10 m)
Frequency band	2.4 GHz band (2.4 to 2.4835 GHz)
Profile	SPP

Parent topic: [Technical Specifications](#)

Label Printer Specifications

Dimensions (approximate)	Width: 2.1 inches (54 mm) Depth: 5.2 inches (132 mm) Height: 5.7 inches (146 mm)
Weight (approximate; excluding batteries and tape cartridge)	0.97 lb (440 g)
Supported tape widths	1/4, 3/8, 1/2, 3/4, and 1 inch (6, 9, 12, 18, and 24 mm)
Interfaces	USB 1.1, Full-speed Bluetooth
Temperature	Operating: 41 to 95 °F (5 to 35 °C) Storage: 14 to 131 °F (−10 to 55 °C)

Parent topic: [Technical Specifications](#)

Label Printer Power Supply Specifications

AC adapter type	AST1116Z1-1 dedicated adapter, power cable only
Manufacturer	Seiko Epson Corp.
Input	AC100–240V, 0.4A, 50–60Hz
Output	DC11V, 1.64A
Total output power	18 W

Battery

AA alkaline battery × 6

Parent topic: [Technical Specifications](#)

Notices

Check these sections for important notices about your label printer.

Note: Epson offers a recycling program for end of life products. Please go to [epson.com/recycle](https://www.epson.com/recycle) for information on how to return your products for proper disposal.

[Important Safety Instructions](#)

[FCC Compliance Statement](#)

[Trademarks](#)

[Copyright Notice](#)

Important Safety Instructions

Before using your label printer, read and follow these safety instructions.

[General Label Printer Safety Instructions](#)

[Tape Cartridge Safety Instructions](#)

[AC Adapter Safety Instructions](#)

[Battery Safety Instructions](#)

Parent topic: [Notices](#)

General Label Printer Safety Instructions

- Always use the product as instructed in the manual. Otherwise, damage or injury may occur.
- Do not subject the product to any strong force or shock such as dropping, hitting, or standing on the product.
- Do not spill liquid on the product or use the product with wet hands.
- Do not open any covers on the product other than the tape cover or battery cover.
- Do not touch the print head.
- Turn the product off, unplug the AC adapter and remove the batteries, and refer servicing to qualified service personnel under the following conditions: if liquid or foreign objects get inside the product; if the product does not operate normally or exhibits a distinct change in performance. Continuing to use the product may result in damage or injury.
- To avoid injury, keep your fingers away from the tape ejection slot when printing or using the cutter.

- Do not block or insert objects into the AC adapter port or tape ejection slot.
- Avoid locations that are subject to rapid changes in heat or humidity, shocks or vibrations, or dust.
- Do not place or store the product in the following locations: outdoors or in direct sunlight; near sources of excessive heat, humidity, shocks, vibrations, or dust; where it may get wet or be exposed to excessive humidity; on an unstable place such as a shaky or inclined surface; near potential sources of electromagnetic interference such as loudspeakers or the base units of cordless telephones.
- The product and product manuals may come packaged in plastic bags. Keep plastic bags away from small children to avoid any risk of suffocation.
- If you will not be using the product for a long period, unplug the power cord and remove the batteries.
- Before cleaning, unplug the power cord and remove the batteries. Use only a dry, soft cloth to clean the product; do not use liquid or chemical cleaners.
- Take care not to cut your fingers when cutting tape with scissors.
- Turn the power off after use.

WARNING: The cords included with this product contain chemicals, including lead, known to the State of California to cause birth defects or other reproductive harm. ***Wash hands after handling.*** (This notice is provided in accordance with Proposition 65 in Cal. Health & Safety Code § 25249.5 and following.)

Parent topic: [Important Safety Instructions](#)

Tape Cartridge Safety Instructions



- Use only compatible LC tape cartridges with this label: **TAPE**.
- To avoid damage, do not drop or disassemble tape cartridges.
- Feed the tape using the software commands. Do not forcibly pull out the tape. Otherwise, you may damage the tape cartridge.
- Do not try to print with an empty tape cartridge; this may overheat the print head and damage the product.

Note: Tape cartridges contain ink ribbons. Make sure to follow local ink disposal regulations.

Parent topic: [Important Safety Instructions](#)

Related references

[Label Editor Printer Settings](#)

Related tasks

[Printing Labels With Label Editor Lite](#)

AC Adapter Safety Instructions

- Use only the AC adapter and power cord that came with your product. Do not use the AC adapter with any other equipment and use only with the specified voltage. Using the wrong AC adapter and power cord may result in damage, overheating, fire, or electric shock.
- Plug the power cord firmly into the outlet. When removing the plug from the outlet, grasp the plug firmly and do not pull on the cord.
- Make sure the plug is not dusty when inserting it into an outlet.
- Do not hold the plug with wet hands.
- Do not make any modifications to the AC adapter or power cord.
- Place the AC adapter and power cord to avoid abrasions, cuts, fraying, crimping, and kinking. Do not place heavy objects on top of the AC adapter or power cord.
- Do not use the AC adapter in a confined space or cover it with a cloth. Make sure the AC adapter has sufficient ventilation so that it does not overheat and become damaged.
- Do not forcibly bend or twist the power cord.
- Do not place the AC adapter or power cord near a heater.
- To avoid fire or electric shock, do not use a damaged AC adapter or power cord.
- Turn off the product before unplugging the AC adapter. Otherwise, it may not function properly or may become damaged.

Parent topic: [Important Safety Instructions](#)

Battery Safety Instructions

- Use batteries properly to avoid injury or fire caused by leaking, overheating, explosion, erosion, or any other damage to the product.
- Keep batteries out of reach of children. If battery acid gets into your eyes or on your skin, immediately rinse the affected area thoroughly with water and seek medical treatment. If a battery is swallowed, seek medical treatment immediately.
- If battery acid leaks from a battery, wipe it off with a cloth and replace the battery with a new one.
- Use AA alkaline batteries.
- Do not use new and old batteries together or mix different types of batteries.

- Insert batteries so that the polarities (+ and –) are correct.
- Remove dead batteries promptly.
- Do not heat batteries or throw them in fire or water.
- Do not remove batteries with metal objects such as tweezers or the tip of a pen.
- Make sure to follow local battery disposal regulations.

Parent topic: [Important Safety Instructions](#)

FCC Compliance Statement

This device complies with Part 15 of the FCC Rules. Operation is subject to the following two conditions: (1) This device may not cause harmful interference, and (2) this device must accept any interference received, including interference that may cause undesired operation.

Caution

Changes or modifications not expressly approved by the party responsible for compliance could void the user's authority to operate this equipment.

An AC adapter with ferrite core must be used for RF interference suppression.

For United States Users

This equipment has been tested and found to comply with the limits for a Class B digital device, pursuant to Part 15 of the FCC Rules. These limits are designed to provide reasonable protection against harmful interference in a residential installation. This equipment generates, uses, and can radiate radio frequency energy and, if not installed and used in accordance with the instructions, may cause harmful interference to radio or television reception. However, there is no guarantee that interference will not occur in a particular installation. If this equipment does cause interference to radio and television reception, which can be determined by turning the equipment off and on, the user is encouraged to try to correct the interference by one or more of the following measures:

- Reorient or relocate the receiving antenna.
- Increase the separation between the equipment and receiver.
- Connect the equipment into an outlet on a circuit different from that to which the receiver is connected.
- Consult the dealer or an experienced radio/TV technician for help.

WARNING

The connection of a non-shielded equipment interface cable to this equipment will invalidate the FCC Certification or Declaration of this device and may cause interference levels which exceed the limits

established by the FCC for this equipment. It is the responsibility of the user to obtain and use a shielded equipment interface cable with this device. If this equipment has more than one interface connector, do not leave cables connected to unused interfaces. Changes or modifications not expressly approved by the manufacturer could void the user's authority to operate the equipment.

For Canadian Users

CAN ICES-3(B)/NMB-3(B).

Parent topic: [Notices](#)

Trademarks

EPSON® is a registered trademark, LabelWorks™ and LC TAPE™ are trademarks, and EPSON Exceed Your Vision is a registered logomark of Seiko Epson Corporation.

Mac and OS X are trademarks and App Store is a service mark of Apple Inc., registered in the U.S. and other countries.

General Notice: Other product names used herein are for identification purposes only and may be trademarks of their respective owners. Epson disclaims any and all rights in those marks.



Parent topic: [Notices](#)

Copyright Notice

All rights reserved. No part of this publication may be reproduced, stored in a retrieval system, or transmitted in any form or by any means, electronic, mechanical, photocopying, recording, or otherwise, without the prior written permission of Seiko Epson Corporation. The information contained herein is designed only for use with this Epson product. Epson is not responsible for any use of this information as applied to other products.

Neither Seiko Epson Corporation nor its affiliates shall be liable to the purchaser of this product or third parties for damages, losses, costs, or expenses incurred by purchaser or third parties as a result of: accident, misuse, or abuse of this product or unauthorized modifications, repairs, or alterations to this product, or (excluding the U.S.) failure to strictly comply with Seiko Epson Corporation's operating and maintenance instructions.

Seiko Epson Corporation shall not be liable for any damages or problems arising from the use of any options or any consumable products other than those designated as Original Epson Products or Epson Approved Products by Seiko Epson Corporation.

Seiko Epson Corporation shall not be held liable for any damage resulting from electromagnetic interference that occurs from the use of any interface cables other than those designated as Epson approved Products by Seiko Epson Corporation.

This information is subject to change without notice.

[Copyright Attribution](#)

Parent topic: [Notices](#)

Copyright Attribution

© 2014 Epson America, Inc.

1/14

CPD-40145R1

Parent topic: [Copyright Notice](#)