

MX240P/ MX340P/ MX640P Series

**THERMAL TRANSFER / DIRECT THERMAL
BAR CODE PRINTER**

**USER'S
MANUAL**

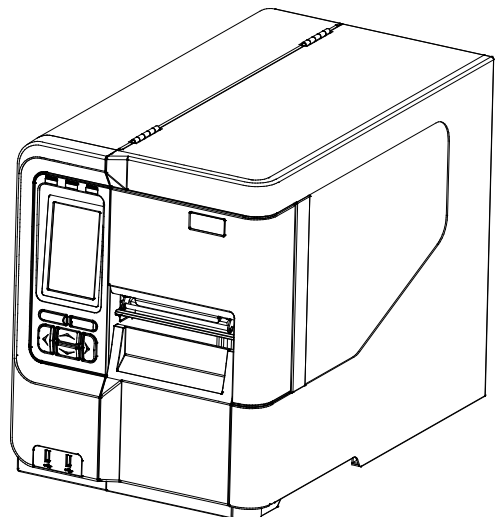

Copyright Information

©2016 TSC Auto ID Technology Co., Ltd,









The copyright in this manual, the software and firmware in the printer described therein are owned by TSC Auto ID Technology Co., Ltd, All rights reserved.

CG Triumvirate is a trademark of Agfa Corporation. CG Triumvirate Bold Condensed font is under license from the Monotype Corporation. Windows is a registered trademark of Microsoft Corporation.

All other trademarks are the property of their respective owners.

Information in this document is subject to change without notice and does not represent a commitment on the part of TSC Auto ID Technology Co. No part of this manual may be reproduced or transmitted in any form or by any means, for any purpose other than the purchaser's personal use, without the expressed written permission of TSC Auto ID Technology Co.

Agency Compliance and Approvals

	EN 55022, Class B EN 55024 EN 60950-1 EN 55032 EN 61000-3-2 EN 61000-3-3
	FCC part 15B, Class B
	AS/NZS CISPR 22/ 32, Class B
	UL 60950-1
	EN 60950-1
	GB 4943.1 GB 9254 GB 17625.1
	TP TC 004 TP TC 020
	IS 13252(Part 1)/ IEC 60950-1
	ENERGY STAR Imaging Equipment 2.0

Important safety instructions:

1. Read all of these instructions and keep them for later use.
2. Follow all warnings and instructions on the product.
3. Disconnect the power plug from the AC outlet before cleaning or if fault happened.

Do not use liquid or aerosol cleaners. Using a damp cloth is suitable for cleaning.

4. The mains socket shall be installed near the equipment and easily accessible.
5. The unit must be protected against moisture.
6. Ensure the stability when installing the device, Tipping or dropping could cause damage.
7. Make sure to follow the correct power rating and power type indicated on marking label

provided by manufacture.

8. Please refer to user manual for maximum operation ambient temperature.

WARNING:

Hazardous moving parts, keep fingers and other body parts away.

CAUTION:

(For equipment with RTC (CR2032) battery or rechargeable battery pack)

Risk of explosion if battery is replaced by an incorrect type.

Dispose of used batteries according to the Instructions as below.

1. DO NOT throw the battery in fire.
2. DO NOT short circuit the contacts.
3. DO NOT disassemble the battery.
4. DO NOT throw the battery in municipal waste.
5. The symbol of the crossed out wheeled bin indicates that the battery should not be placed in municipal waste.



Caution: The printhead may be hot and could cause severe burns. Allow the printhead to cool.

FCC STATEMENT :

This equipment has been tested and found to comply with the limits for a Class B digital device, pursuant to part 15 of the FCC Rules. These limits are designed to provide reasonable protection against harmful interference in a residential installation. This equipment generates, uses and can radiate radio frequency energy and, if not installed and used in accordance with the instructions, may cause harmful interference to radio communications. However, there is no guarantee that interference will not occur in a particular installation. If this equipment does cause harmful interference to radio or television reception, which can be determined by turning the equipment off and on, the user is encouraged to try to correct the interference by one or more of the following measures:

- Reorient or relocate the receiving antenna.
- Increase the separation between the equipment and receiver.
- Connect the equipment into an outlet on a circuit different from that to which the receiver is connected.
- Consult the dealer or an experienced radio/ TV technician for help.

This device complies with Part 15 of the FCC Rules. Operation is subject to the following two conditions: (1) This device may cause harmful interference, and (2) this device must accept any interference received, including interference that may cause undesired operation.

This Class B digital apparatus complies with Canadian ICES-003

Cet appareil numérique de la classe B est conforme à la norme NMB-003 du Canada.

CAUTION:

Any changes or modifications not expressly approved by the grantee of this device could void the user's authority to operate the equipment.

Contents

- 1. Introduction 1
 - 1.1 Product Introduction 1
 - 1.2 Product Features 2
 - 1.2.1 Printer Standard Features 2**
 - 1.2.2 Printer Optional Features 4**
 - 1.3 Printer Specifications 4
 - 1.4 Print Specifications 5
 - 1.5 Ribbon Specifications 5
 - 1.6 Media Specifications 6
- 2. Operations Overview 7
 - 2.1 Unpacking and Inspection 7
 - 2.2 Printer Overview 8
 - 2.2.1 Front View 8**
 - 2.2.2 Interior view 9**
 - 2.2.3 Rear View 10**
 - 2.3 Operator Control 12
 - 2.3.1 LED Indication and Keys 12**
 - 2.3.2 Main page Icons 13**
 - 2.3.3 Touch Screen 14**
- 3. Setup 15
 - 3.1 Setting up the printer 15
 - 3.2 Loading the Ribbon 16
 - 3.3 Loading the Media 19
 - 3.3.1 Loading the Media 19**
 - 3.3.2 Loading the Fan-fold/External Media 22**
 - 3.3.3 Loading Media in Peel-off Mode (Option) 23**
 - 3.3.4 Loading Media in Rewind Mode (Option) 26**
- 4. Moveable Print Head Pressure Adjustment Knob 28
 - 4.1 Mechanism Fine Adjustment to Avoid Ribbon Wrinkles 28
- 5. Ribbon Tension Adjustment Knob 30
 - 5.1 Suggestion of Ribbon Tension Adjustment 31
- 6. Diagnostic Tool 33
 - 6.1 Start the Diagnostic Tool 33

6.2 Printer Function	34
6.3 Setting Ethernet by Diagnostic Tool.....	35
6.3.1 Using USB interface to setup Ethernet interface.....	35
6.3.2 Using RS-232 interface to setup Ethernet interface.....	36
6.3.3 Using Ethernet interface to setup Ethernet interface.....	37
7. LCD Menu Function	39
7.1 Enter the Menu	39
7.2 Menu Overview.....	40
7.3 Setting.....	41
7.3.1 TSPL.....	41
7.3.2 ZPL2	43
7.4 Sensor	46
7.5 Interface.....	47
7.5.1 Serial Comm.....	47
7.5.2 Ethernet	48
7.5.3 Wi-Fi.....	49
7.5.4 Bluetooth.....	49
7.6 Advanced.....	50
7.7 File Manager.....	52
7.8 Diagnostic.....	53
7.9 Favorites.....	55
8 Troubleshooting.....	56
9 Maintenance.....	59
Revise History	60

1. Introduction

1.1 Product Introduction

Thank you very much for purchasing TSC bar code printer.

The new high performance MX240P Series was designed to deliver 24x7 high volume performance. It features a die-cast aluminum print mechanism housed in a very strong yet lightweight cabinet. This new design results in a more durable printer that is suited for your most heavy-duty demand cycles.

There are three models available with the MX240P Series. The MX240P prints at 203 dpi at speeds up to an amazing 18 inches per second, MX340P offers higher 300 dpi resolution at speeds up to 14 inches per second, and the MX640P features 600 dpi high resolution which makes it ideal for printing very small 2D barcodes, graphics, fine print and other ultra-high-resolution images.

The MX240P Series printers are loaded with standard features including a color touch display with new GUI design and six menu buttons to provide a great user experience, support for 600 meter ribbons, 8" OD media rolls, built-in Ethernet, two USB hosts for keyboard and scanner connections, and USB 2.0 and serial interfaces. Parallel and GPIO ports are available as an option.

This document provides an easy reference for operating the MX240P series. To print label formats, please refer to the instructions provided with your labeling software; if you need to write the custom programs, please refer to the TSPL/TSPL2 programming manual that can be found on the accessories CD-ROM or on TSC website at <http://www.tscprinters.com>.

- Applications
 - High volume printing
 - Work in process
 - Compliance labeling
 - Inventory management
 - Shipping/ receiving
 - Asset management
 - Electronics & Jewelry labeling

1.2 Product Features

1.2.1 Printer Standard Features

The printer offers the following standard features.

Product standard feature	
Printing method	Thermal transfer/ or direct thermal
Mechanism	Die-cast based print mechanism and frame / Aluminum cover with large clear media view window
LCD display/ Operation buttons	Multi-language selectable Large Backlit LCD display (LCD: 16 bits Color, Resolution 480 x 272 ; Resistive Touch Screen) with 6 buttons & 3 LEDs
Processor	32-bit RISC high performance processor (BGA 536Mhz)
Memory	<ul style="list-style-type: none"> ▪ 512 MB Flash memory ▪ 512 MB SDRAM memory (DDR2) ▪ Micro SD card reader for memory expansion, up to 32GB
Interface	<ul style="list-style-type: none"> ▪ RS-232 (Max. 115,200 bps) ▪ USB 2.0 (High speed mode) ▪ Internal Ethernet print server (10/100 Mbps) ▪ USB host *2 (Front side/ support USB HID only)
Sensors	<ul style="list-style-type: none"> ▪ Gap transmissive sensor (Position adjustable, 15mm -> 98mm) ▪ Black mark reflective sensor (Position adjustable, 15mm -> 92mm) ▪ Ribbon end sensor (transmissive) ▪ Ribbon encoder sensor ▪ Head open sensor ▪ Media capacity sensor
Internal font	<ul style="list-style-type: none"> ▪ 8 alpha-numeric bitmap fonts ▪ One Monotype Imaging® CG Triumvirate Bold Condensed scalable font
Supported code page	<ul style="list-style-type: none"> ▪ Codepage 437 (English - US) ▪ Codepage 737 (Greek) ▪ Codepage 850 (Latin-1) ▪ Codepage 852 (Latin-2) ▪ Codepage 855 (Cyrillic) ▪ Codepage 857 (Turkish) ▪ Codepage 860 (Portuguese) ▪ Codepage 861 (Icelandic) ▪ Codepage 862 (Hebrew) ▪ Codepage 863 (French Canadian) ▪ Codepage 864 (Arabic) ▪ Codepage 865 (Nordic) ▪ Codepage 866 (Russian) ▪ Codepage 869 (Greek 2) ▪ Codepage 950 (Traditional Chinese) ▪ Codepage 936 (Simplified Chinese) ▪ Codepage 932 (Japanese) ▪ Codepage 949 (Korean) ▪ Codepage 1250 (Latin-2) ▪ Codepage 1251 (Cyrillic) ▪ Codepage 1252 (Latin-1) ▪ Codepage 1253 (Greek) ▪ Codepage 1254 (Turkish) ▪ Codepage 1255 (Hebrew) ▪ Codepage 1256 (Arabic)

	<ul style="list-style-type: none"> ▪ Codepage 1257 (Baltic) ▪ Codepage 1258 (Vietnam) ▪ ISO-8859-1: Latin-1 (Western European) ▪ ISO-8859-2: Latin-2 (Central European) ▪ ISO-8859-3: Latin-3 (South European) ▪ ISO-8859-4: Latin-4 (North European) ▪ ISO-8859-5: Cyrillic ▪ ISO-8859-6: Arabic ▪ ISO-8859-7: Greek ▪ ISO-8859-8: Hebrew ▪ ISO-8859-9: Turkish ▪ ISO-8859-10: Nordic ▪ ISO-8859-15: Latin-9 ▪ UTF-8 	
Supported bar code	1D bar code Code128 subsets A.B.C, Code128UCC, EAN128, Interleave 2 of 5, Code 39, Code 93, EAN-13, EAN-8, Codabar, POSTNET, UPC-A, UPC-E, EAN and UPC 2(5) digits, MSI, PLESSEY, China Post, ITF14, EAN14, Code 11, TELPEN, PLANET, Code 49, Deutsche Post Identcode, Deutsche Post Leitcode, LOGMARS	2D bar code CODABLOCK F mode, DataMatrix, Maxicode, PDF-417, Aztec, MicroPDF417, QR code, RSS Barcode (GS1 Databar)
Font & bar code rotation	0, 90, 180, 270 degree	
Command set	TSPL-EZ™	
Others	<ul style="list-style-type: none"> ▪ Standard for real time clock ▪ Standard for buzzer ▪ Standard industry emulations right out of the box including Eltron® and Zebra® language support ▪ Built-in Monotype True Type Font engine ▪ Downloadable fonts from PC to printer memory ▪ Print head pressure force & pressure location adjustable ▪ Ribbon supply spindle tension adjustable ▪ Automatic media/ribbon sensor selecting ▪ Heater element damage detection ▪ Clean print head warning 	

1.2.2 Printer Optional Features

The printer offers the following optional features.

Product option feature	User option	Dealer option	Factory option
Option Card (GPIO + Parallel)		<input type="radio"/>	
Internal full rewinding kit (Max. 8" OD)			<input type="radio"/>
Peel-off module assembly (Max.4 ips)		<input type="radio"/>	
Regular guillotine cutter (Max.4 ips) 0.06~0.25 mm thickness		<input type="radio"/>	
Heavy duty cutter Paper weight <300g/m ²		<input type="radio"/>	
Internal Bluetooth 4.0		<input type="radio"/>	
Wi-Fi a/b/g/n band (Slot-in)	<input type="radio"/>		
KP-200 Plus keyboard display unit	<input type="radio"/>		
KU-007 Plus programmable smart keyboard	<input type="radio"/>		

1.3 Printer Specifications

Printer Specifications	
Physical dimensions	298 mm (W) x 393 mm (H)x 510 mm (D)
Weight	18 kg (39.68 lbs)
Power	Auto sensing power supply (20% print ratio) • Input: AC 100-240V, 4-2A, 50-60Hz • Output: DC 5V, 5A; DC 24V, 7A; DC 36V, 1.4A; Total 243W Note: ▪ The max. full web black bar is limited to 5 mm only, otherwise printer may stop printing to protect power supply. ▪ Default delay time to power saver mode for standard model is 60 minutes.
Environmental condition	Operation: 5 ~ 40 °C (41 ~ 104 °F), 25~85% non-condensing Storage: -40 ~ 60 °C (-40 ~ 140 °F), 10~90% non-condensing

1.4 Print Specifications

Print Specifications	MX240P	MX340P	MX640P
Print head resolution (dots per inch/mm)	203 dots/inch (8 dots/mm)	300 dots/inch (12 dots/mm)	600 dots/inch (24 dots/mm)
Printing method	Thermal transfer/ or direct thermal		
Dot size (width x length)	0.125 x 0.125 mm (1 mm = 8 dots)	0.084 x 0.084 mm (1 mm = 12 dots)	0.042 x 0.042 mm (1 mm = 24 dots)
Print speed (inches per second)	2,3,4,5...18 ips selectable	2,3,4,5...14 ips selectable	1.5,2,3.... 6 ips selectable
	Up to 18 IPS	Up to 14 IPS	Up to 6 IPS
	Max. 4 ips for peeler mode		
Max. print width	4.09" (104 mm)		
Max. print length	1000" (25400 mm)	450" (11430 mm)	100" (2540 mm)
Printout bias	Vertical: 0.3 ~ 1 mm max. Horizontal: 1 mm max.		

1.5 Ribbon Specifications

Ribbon Specifications	
Ribbon outside diameter	Max. 90 OD
Ribbon length	600 meter
Ribbon core inside diameter	1" (25.4 mm)
Ribbon width	25.4 mm ~ 114.3 mm (1"~4.5")
Ribbon wound type	Ink coated outside wound, ink coated inside wound
Ribbon end type	Transparency

1.6 Media Specifications

Media Specifications	MX240P	MX340P	MX640P
Media roll capacity	Max. 8" (203.2 mm) OD		
Media core diameter	3" (76.2 mm) ID core		
Media type	Continuous, die-cut, black mark, external fan-fold, notch		
Media wound type	Outside wound		
Media width	20 mm ~ 114 mm (0.78" ~ 4.49")		
Media thickness	0.076 mm ~ 0.305 mm (2.99 ~ 12.01 mil)		
Label length	3 mm ~		
Label length (peeler mode)	25 mm ~ 152 mm (1" ~ 6")		
Label length (cutter mode)	200dpi: 25.4~2,286 mm (1" ~ 90")	300dpi & 600dpi: 25.4~1016 mm (1" ~ 40")	
Black mark	Min. 8 mm (W) x Min. 2 mm (H)		
Gap height	Min. 2 mm		

2. Operations Overview

2.1 Unpacking and Inspection

This printer has been specially packaged to withstand damage during shipping. Please carefully inspect the packaging and printer upon receiving the bar code printer. Please retain the packaging materials in case you need to reship the printer.

Unpacking the printer, the following items are included in the carton.

- One printer unit
- One Windows labeling software/Windows driver CD disk
- One quick installation guide
- One power cord
- One USB interface cable

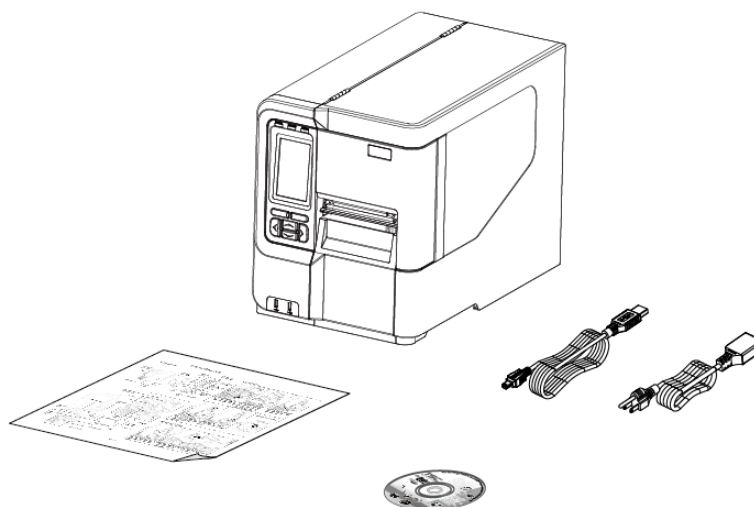

If any parts are missing, please contact the Customer Service Department of your purchased reseller or distributor.

2.2 Printer Overview

2.2.1 Front View

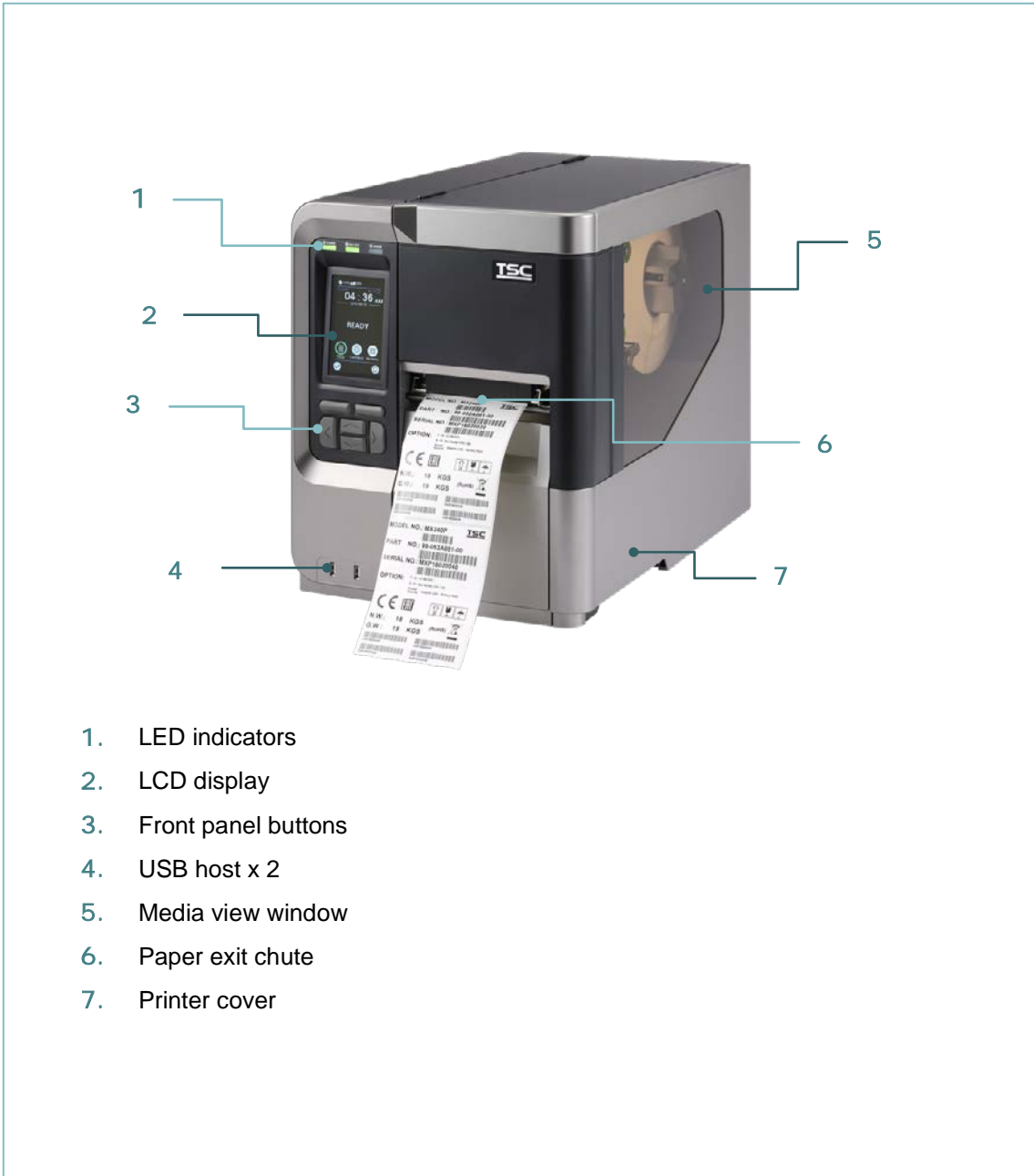

1. LED indicators
2. LCD display
3. Front panel buttons
4. USB host x 2
5. Media view window
6. Paper exit chute
7. Printer cover

2.2.2 Interior view

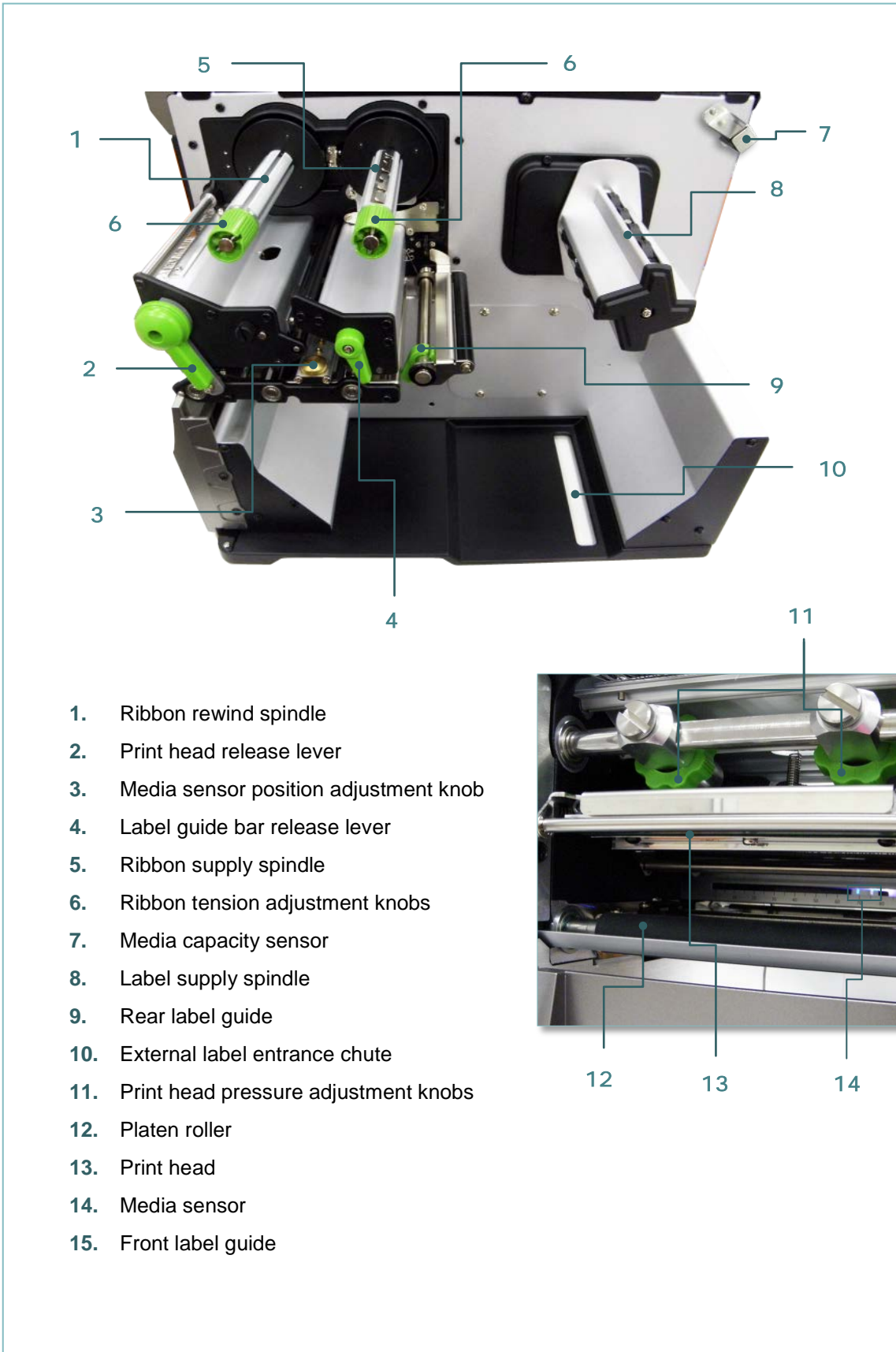

2.2.3 Rear View

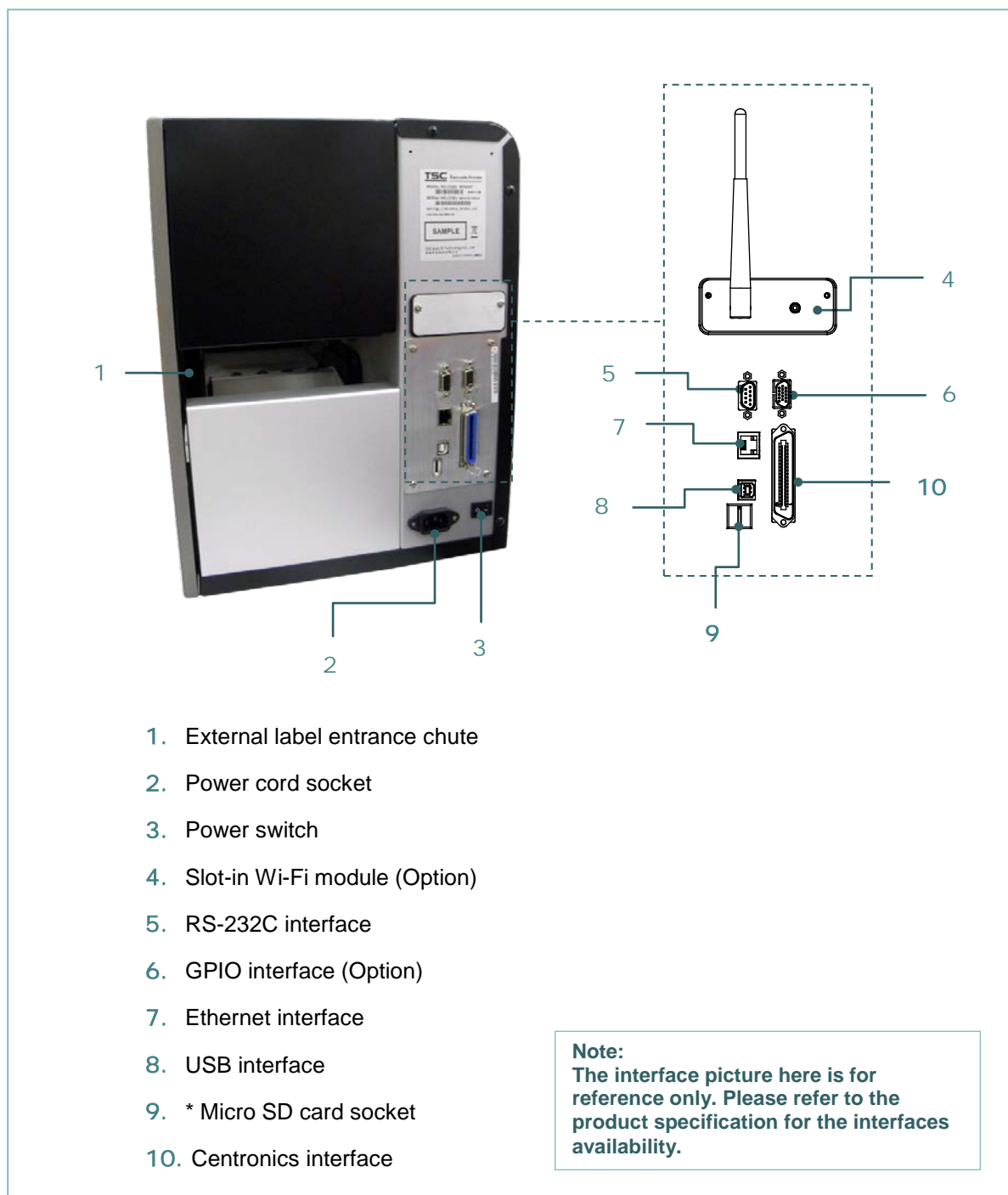

* Recommended SD card specification.

Type	SD card spec	SD card capacity	Approved SD card manufacturer
Micro SD	V2.0 Class 4	4G	Transcend
	V2.0 Class 4	8G	Transcend
	V3.0 Class 10 UHS-I	16G	Transcend
	V3.0 Class 10 UHS-I	32G	Transcend
	V3.0 Class 10	16G	Kingston
	V2.0 Class 4	16G	Scandisk
	V3.0 Class 10 UHS-I	16G	Scandisk

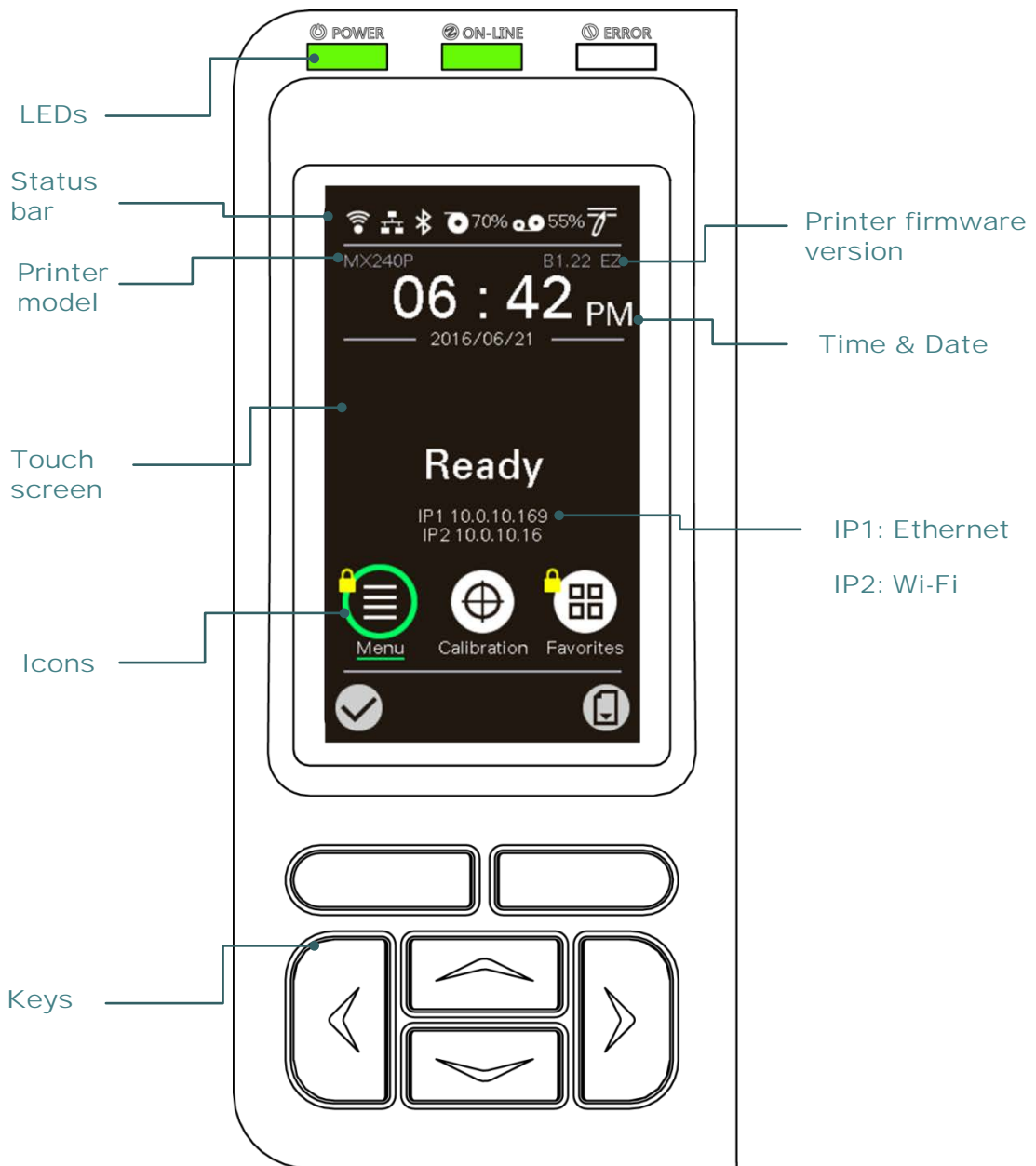

- The DOS FAT file system is supported for the SD card.
- Folders/files stored in the SD card should be in the 8.3 filename format.
- The miniSD/microSD card to SD card slot adapter is required.

2.3 Operator Control















2.3.1 LED Indication and Keys

LED	Status	Indication
POWER	Off	Printer power off
	On	Printer power on
ON-LINE	On	Printer is ready
	Blinking	Printer is paused
		Printer is downloading data

ERROR	Off	Printer is ready
	On	Carriage open or cutter error
	Blinking	No paper, paper jam or no ribbon
Keys		Function
Soft keys 		The labels on the footer of the UI will explain the function for left and right soft key. Check the labels on the footer of the UI screen. The meaning of the soft keys will vary.
Navigational keys 		Used to select icons, menu selection, and navigation in the UI.

2.3.2 Main page Icons

Indicated icon	Indication
	Wi-Fi device is ready (option)
	Ethernet is connected
	Bluetooth device is ready (option)
	Media capacity %
	Ribbon capacity %
	TPH cleaning
	Security lock
Icon button	Function
	Enter the menu
	Calibrate the media sensor
	Enter the “Favorites” option (please refer to section 7.9)
	Enter cursor (be marked in green) located option
	Feed button (advance one label)

2.3.3 Touch Screen

Tap an item to open/use it.



Note:
For LCD Menu panel, please refer to section 7 for more details.

3. Setup

3.1 Setting up the printer

1. Place the printer on a flat, secure surface.
2. Make sure the power switch is off.
3. Connect the printer to the computer with the provided USB cable.
4. Plug the power cord into the AC power cord socket at the rear of the printer, and then plug the power cord into a properly grounded power outlet.

Note: Please switch OFF printer power switch prior to plug in the power cord to printer power jack.

3.2 Loading the Ribbon



1. Open the printer right side cover.



2. Install the ribbon and paper core onto ribbon supply spindle and ribbon rewind spindle.

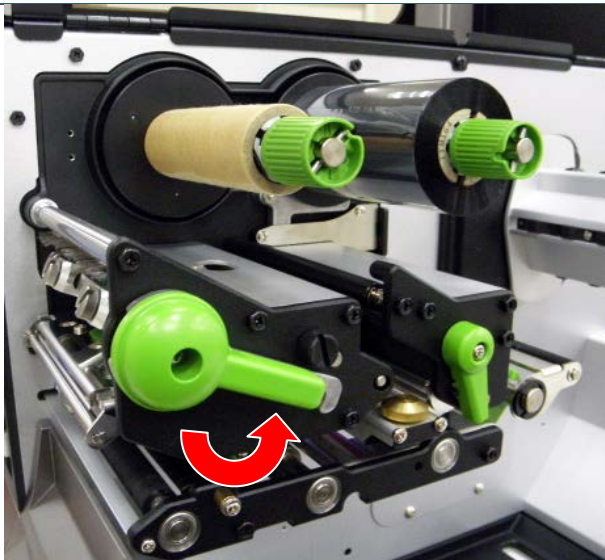

3. Push print head release lever to open print head mechanism.

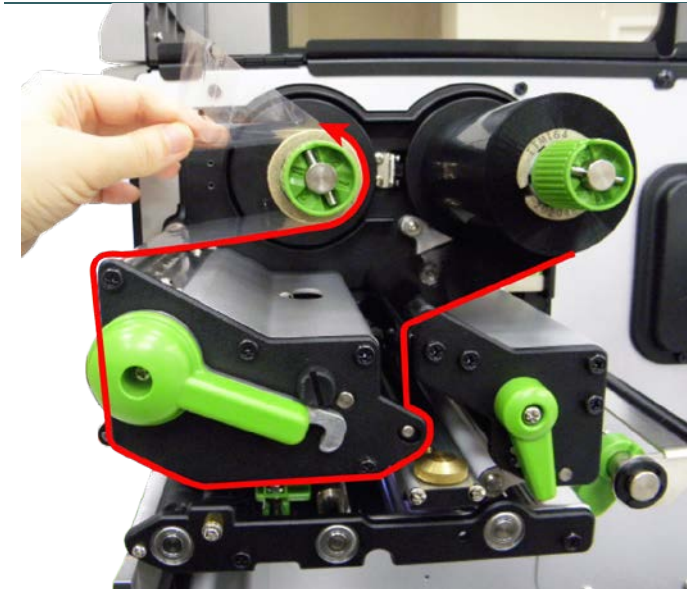

4. Thread ribbon above the ribbon guide bar and through ribbon sensor slot. (Please refer to "Loading path for ribbon" as following fig.)

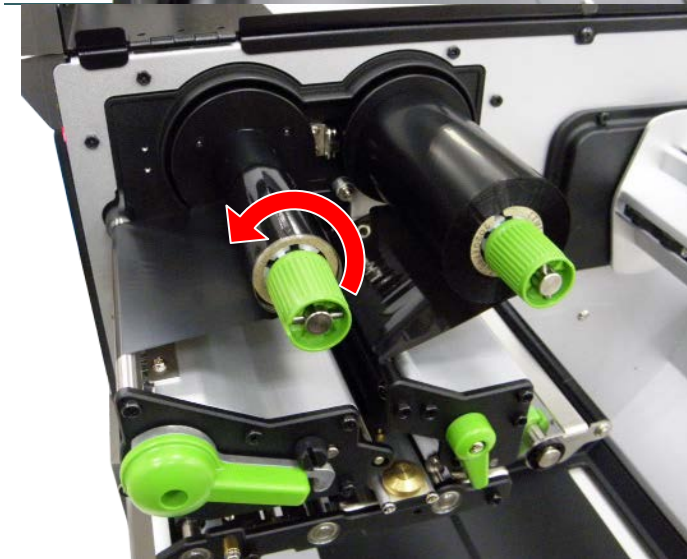

5. Wind the ribbon rewind spindle counterclockwise roughly 3~5 circles until ribbon is smooth, properly stretched and wrinkle-free.

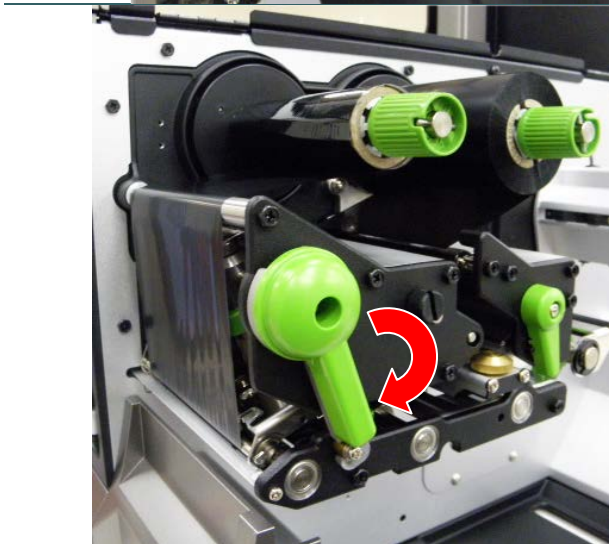

6. Close the print head mechanism by pushing the print head release lever.

Note:

* Please refer to video on [TSC YouTube](#).

Loading path for ribbon

* Ink coated outside wound

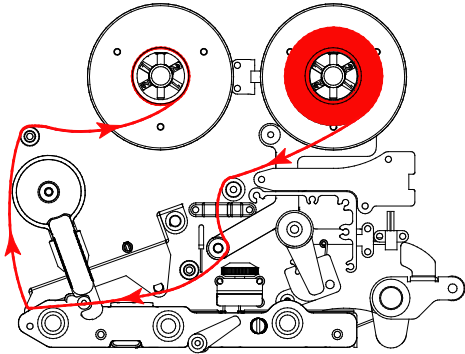

* Ink coated inside wound

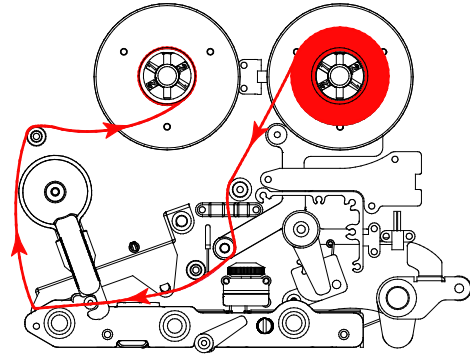

3.3 Loading the Media

3.3.1 Loading the Media



1. Open the printer right side cover.

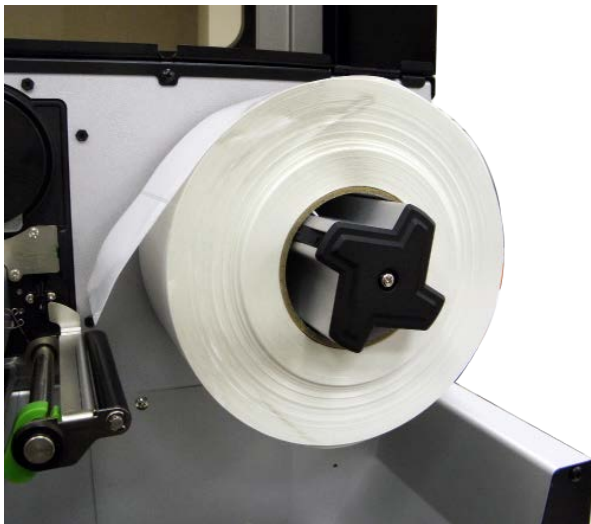

2. Place the roll of media on the label supply spindle.
Note:
For 1"~2.5" width media, please install label roll guard on the supply spindle to fix media.

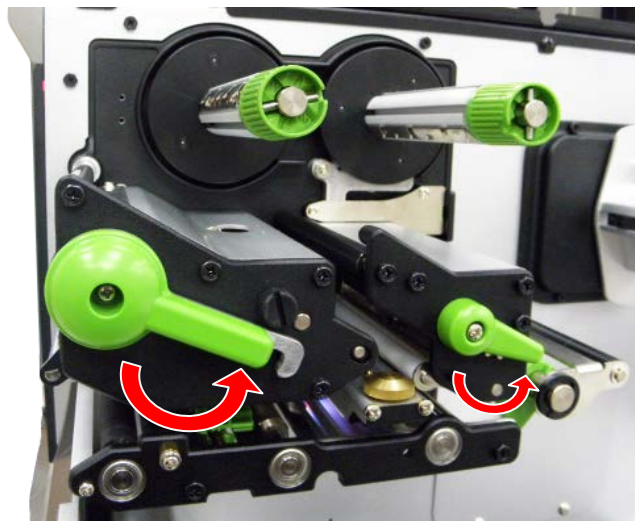
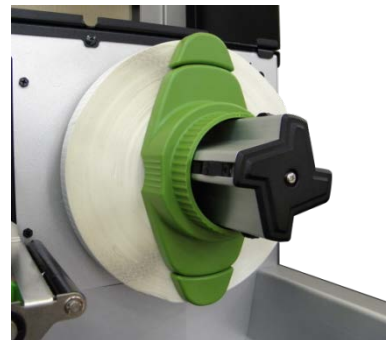

3. Push open the print head release lever and label guide bar release lever for loading media.



4. Pull the leading edge of the label forward through the media guide bar pass media sensor, and place the leading edge onto the platen roller.



5. Adjust the rear label guide (green) to fit the label width.

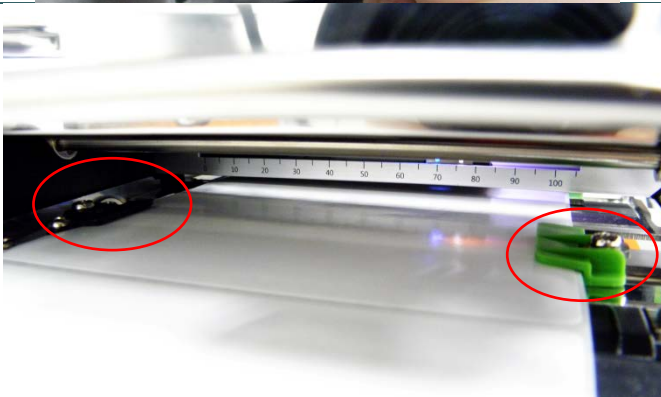

6. Adjust the front label guide (green) to fit the label width.

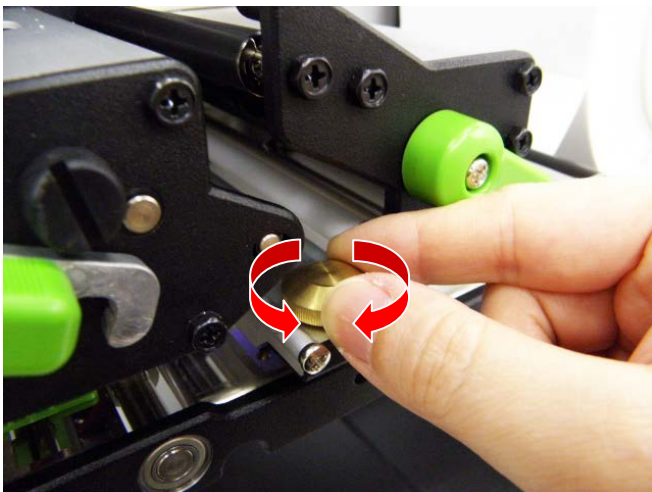

7. Move the media sensor by adjusting the media sensor position adjustment knob, make sure the gap or black mark sensor is at the location where media gap/black mark will pass through for sensing.

Black mark (Blue) **GAP (White)**

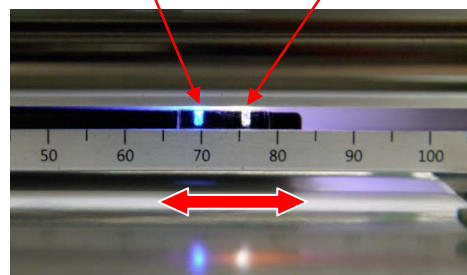

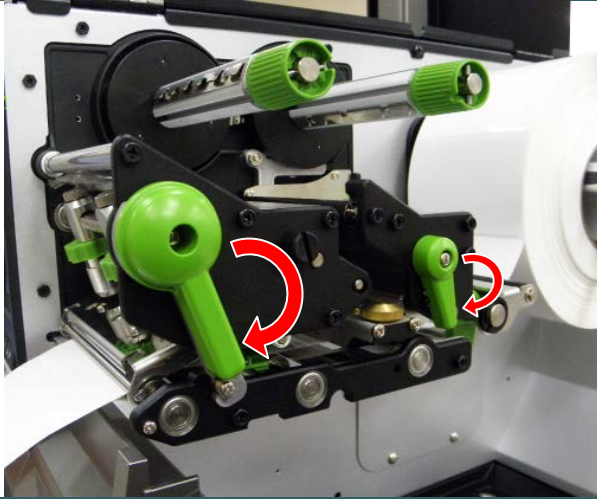

8. Close print head release lever and label guide bar release lever.
9. Set media sensor type and calibrate the selected sensor.

Note:

- * Please calibrate the gap/black mark sensor when changing media.
- * Please refer to video on [TSC YouTube](#) or driver CD.

Loading path for media

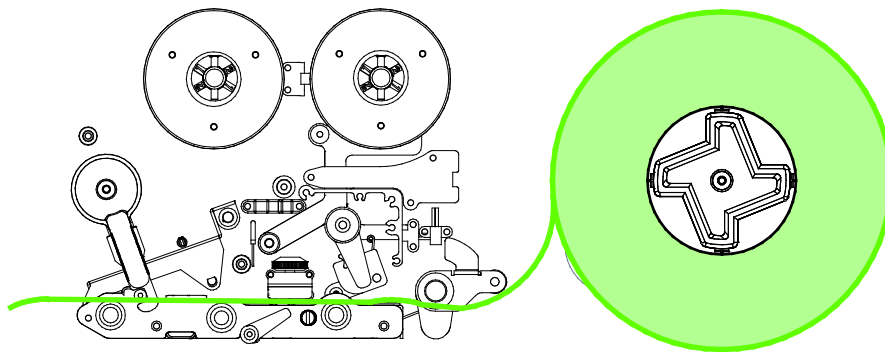

3.3.2 Loading the Fan-fold/External Media



1. Open the printer right side cover.
2. Insert the fan-fold media through the bottom or rear external label entrance chute.
3. Please refer to section 3.3.1 step 3-9 for loading media.

Note:
Please calibrate the gap/black mark sensor when changing media.

Loading path for fan-fold labels

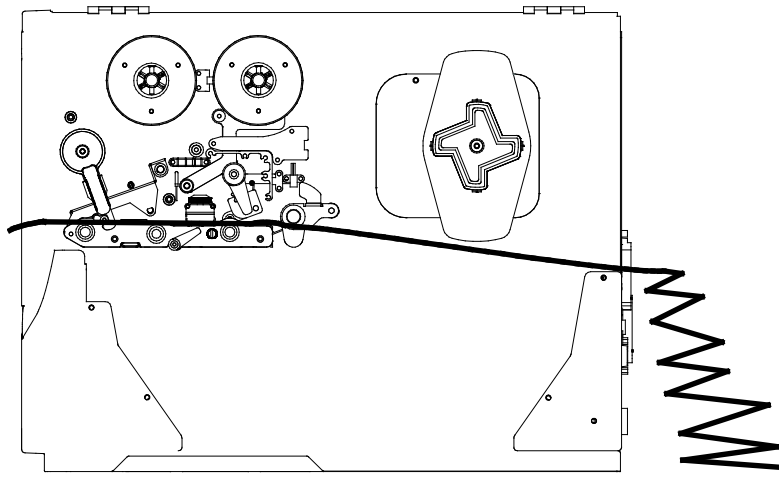

3.3.3 Loading Media in Peel-off Mode (Option)



1. Open the printer right side cover.
2. Please refer to section 3.3.1 step 3~9 for loading media.
3. Using the front display panel to do the calibration first and set the printer mode to peeler mode.

Note:

Please calibrate the gap/black mark sensor before loading media in peel-off mode to avoid paper jam.



4. Open print head release lever and label guide bar release lever to pull approximately 650mm of label through the front of the printer.
5. Remove several labels to leave liner.



6. Install the paper core onto the liner rewind spindle. Open the peel-off roller release lever.

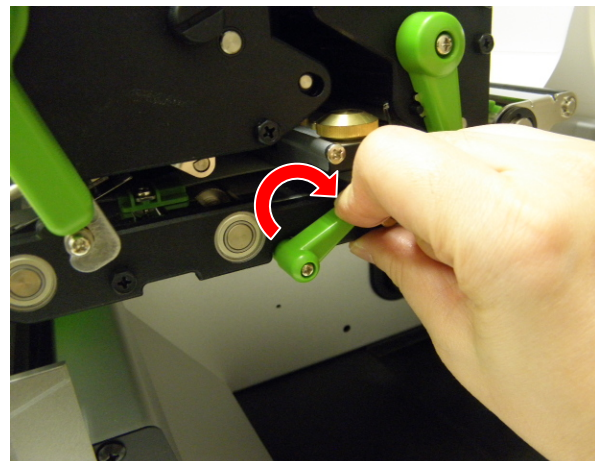

7. Feed the leading edge of liner through the peeler sensor and peel-off roller.

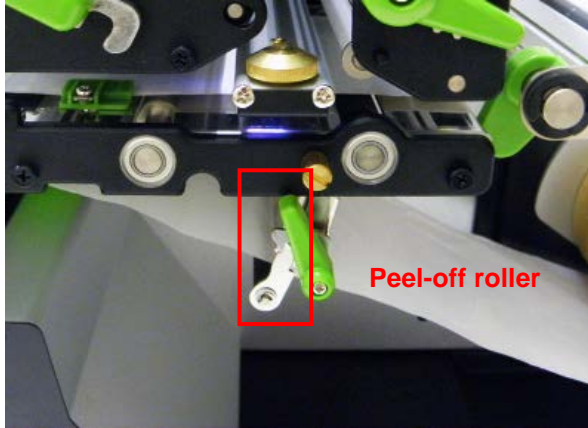
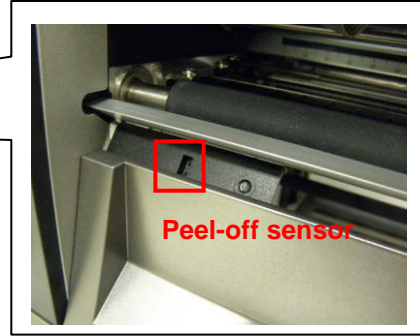
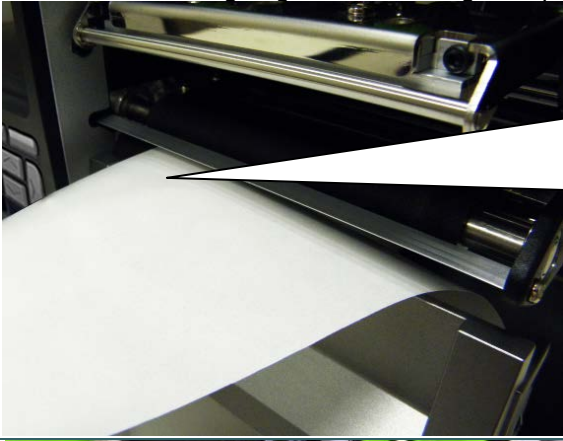

8. Wrap the liner onto the paper core and wind the spindle until the liner stretched properly.

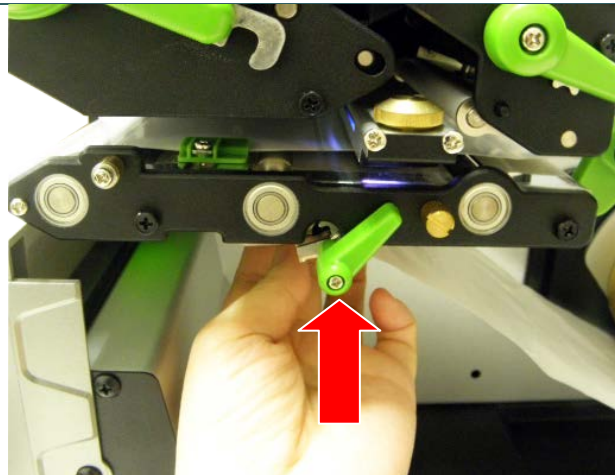

9. Press the middle of the peel-off roller to close the peel-off roller release lever.

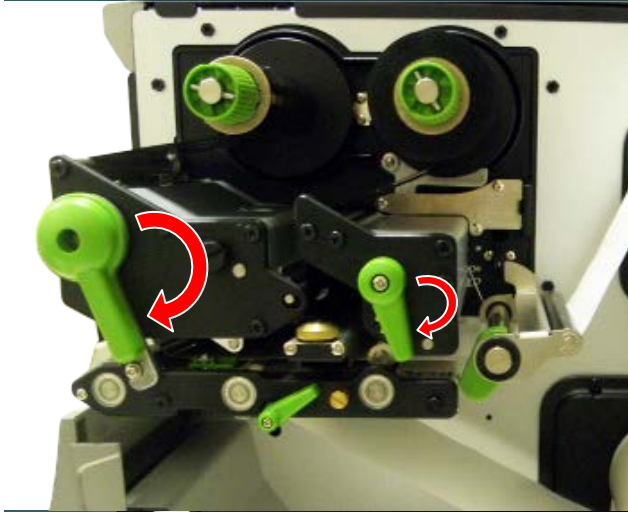

10. Close print head release lever and label guide bar release lever.



11. Press the FEED button to test.

3.3.4 Loading Media in Rewind Mode (Option)



1. Open the printer right side cover.
2. Please refer to section 3.3.1 step 3~9 for loading media.
3. Using the front display panel to do the calibration and set the printer mode to rewind mode.



4. Install the paper core onto the rewind spindle.



5. Open print head release lever and label guide bar release lever to pull approximately 650mm of label through the front of the printer.
6. Feed the leading edge of media through the redirect front panel as picture shown.



7. Wrap the label onto the internal rewind spindle and stick the label onto the paper core. Wind the spindle until the label stretched properly.

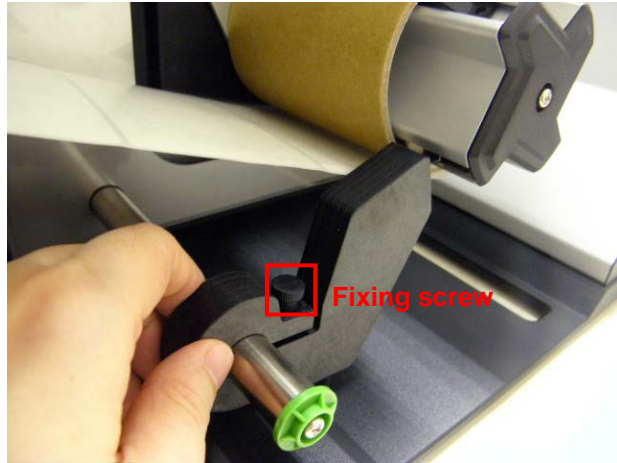

8. Adjust the supply holder guide to fit the supply width. Turn the screw to fix the supply holder guide.

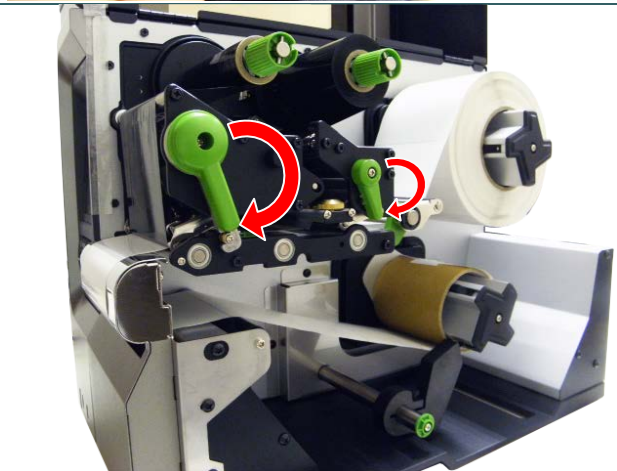

9. Close print head release lever and label guide bar release lever.

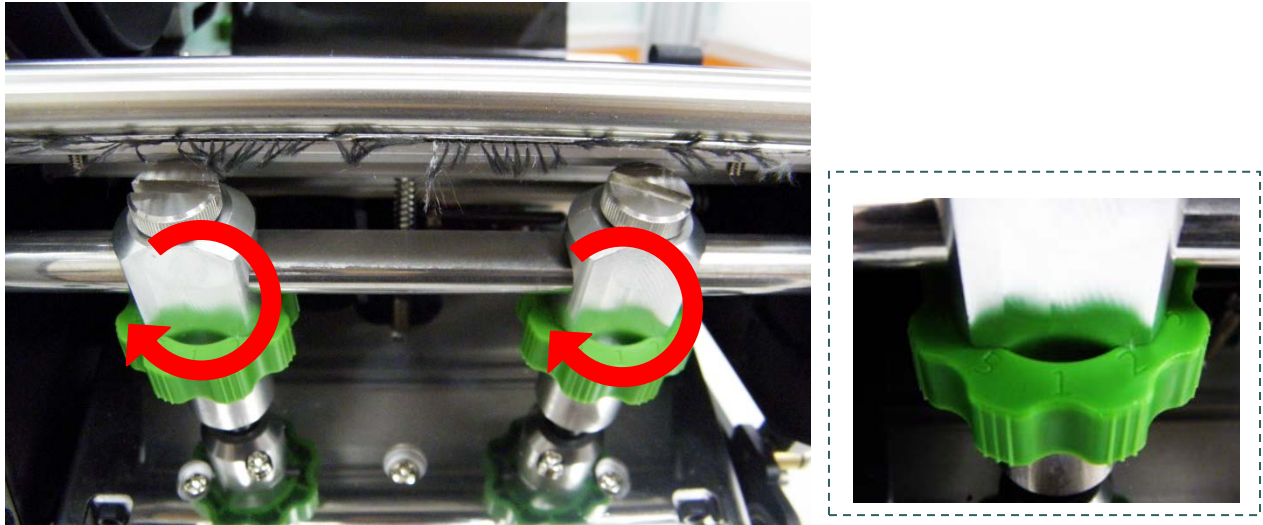

4. Moveable Print Head Pressure Adjustment Knob



The moveable print head pressure adjustment knob has 5 levels of adjustment. Because the printer's paper alignment is to the left side of mechanism, different media widths require different pressure to print correctly. Therefore it may require to adjust the pressure knob to get your best print quality. For example, if the label width is 4", adjust both print head pressure adjustment knobs to the same level. If the label is less than 2" wide, increase the left side print head pressure by rotating the adjustment knob clockwise and decrease the right side pressure by rotating the adjustment knob counter-clockwise to level 1.

4.1 Mechanism Fine Adjustment to Avoid Ribbon Wrinkles

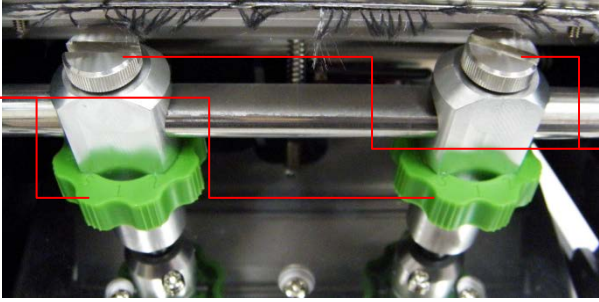
This printer has been fully tested before delivery. There should be no ribbon wrinkle presented on the media for general-purpose printing application. Ribbon wrinkle is related to the media thickness, print head pressure balance, ribbon film characteristics, print darkness setting...etc. In case the ribbon wrinkle happens, please follow the instructions below to adjust the printer parts.

<p>Adjustable Printer Parts</p>	<p>The print head pressure adjustment knob has 5 levels of settings. Clockwise direction adjustment is to increase the print head pressure. Counter Clockwise adjustment can decrease the print head pressure.</p> <div style="display: flex; align-items: center; justify-content: center;"> <div style="margin-right: 20px;">Print head pressure adjustment knobs</div>  <div style="margin-left: 20px;">Fixing screws</div> </div>	
<p>Symptom</p>	<p>1. Wrinkle happens from label lower left to upper right direction (“ ´ ”)</p>	<p>2. Wrinkle happens from label lower right to upper left direction (“ ` ”)</p>
<p>Wrinkle Example</p>	<div style="display: flex; align-items: center; justify-content: center;"> <div style="border: 1px solid black; padding: 5px; margin-right: 20px;"> <p>MODEL NO.:</p> <p>SERIAL NO.: XXXXXXXXXXXX</p> <p>INPUT: 115/230V~,5/3A,50/60Hz</p> <p>This device complies with Part 15 of the FCC Rules. Operation is subject to the following two conditions. (1) This device may not cause harmful interference, and (2) This device must accept any interference received, including interference that may cause undesired operation.</p> <p>THIS DEVICE COMPLIES WITH CANADA ICES-003 CLASS A</p> <p>UL LISTED I.T.E. E178707</p> <p>TUV SUD</p> <p>CE</p> <p>RoHS</p> <p>MADE IN TAIWAN</p> </div> <div style="margin-right: 20px; text-align: center;">  </div> <div style="border: 1px solid black; padding: 5px; margin-right: 20px;"> <p>Feed direction</p> </div> <div style="border: 1px solid black; padding: 5px; margin-left: 20px;"> <p>MODEL NO.:</p> <p>SERIAL NO.: XXXXXXXXXXXX</p> <p>INPUT: 115/230V~,5/3A,50/60Hz</p> <p>This device complies with Part 15 of the FCC Rules. Operation is subject to the following two conditions. (1) This device may not cause harmful interference, and (2) This device must accept any interference received, including interference that may cause undesired operation.</p> <p>THIS DEVICE COMPLIES WITH CANADA ICES-003 CLASS A</p> <p>UL LISTED I.T.E. E178707</p> <p>TUV SUD</p> <p>CE</p> <p>RoHS</p> <p>MADE IN TAIWAN</p> </div> </div>	
	<p>If the wrinkle on the label starts from the lower left side to upper right side, please do following adjustment.</p> <ol style="list-style-type: none"> 1. Decrease the right side print head pressure adjustment knob setting 1 level per each adjustment then print the label again to check if wrinkle is gone. 2. If the right side print head adjustment knob setting has been set to index 1 (the lowest pressure index), please increase the left side print head pressure. 	<p>If the wrinkle on the label starts from the lower right side to upper left side, please do following adjustment.</p> <ol style="list-style-type: none"> 1. Decrease the left side print head pressure adjustment knob setting 1 level per each adjustment then print the label again to check if wrinkle is gone. 2. If the left side print head adjustment knob level has been set to index 1 (the lowest index), please increase the right side print head pressure.

5. Ribbon Tension Adjustment Knob

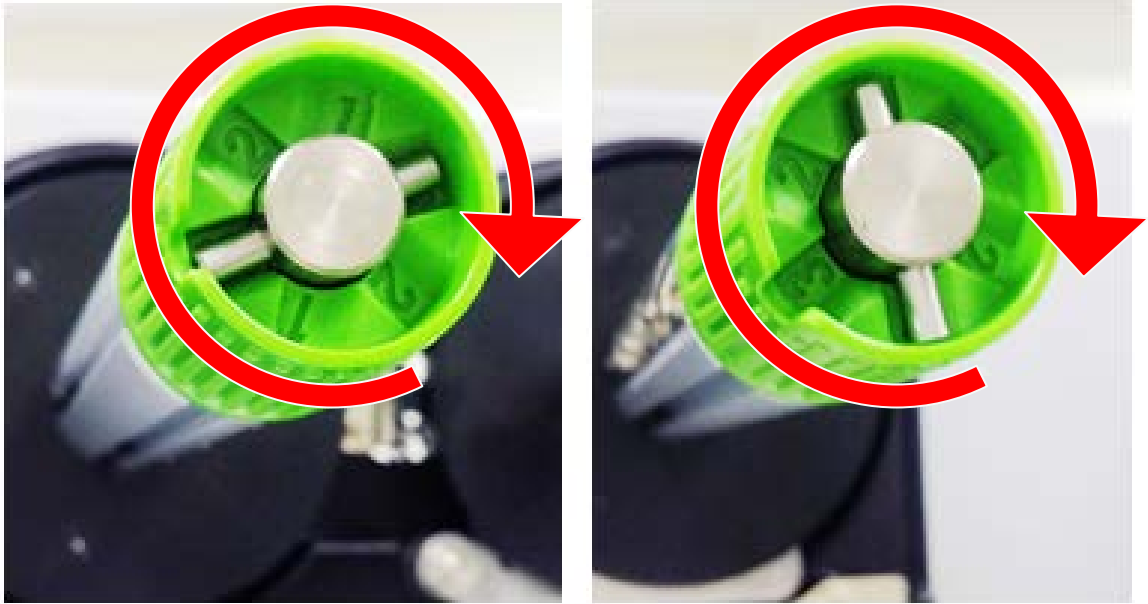

The ribbon tension adjustment knob has 3 levels of adjustment. Because the printer's ribbon alignment is to the left side of mechanism, different ribbon width require different tension to print correctly. Therefore it may require to adjust the ribbon tension knob to get your best print quality. The biggest tension is #1. Adjust the tension by turning the knobs to suitable # (1, 2 or3) on both ribbon supply & rewind spindles, suggest the tension # to be the same on both spindles. Factory default tension is #1.

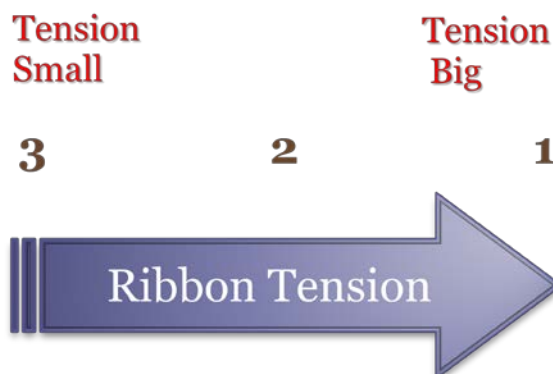

5.1 Suggestion of Ribbon Tension Adjustment

For 4" width ribbon

If the ribbon width is 4", adjust both ribbon tension adjustment knobs to the #1 on ribbon supply & rewind spindles. (Factory default tension is #1)

Ribbon Rewind Spindle
Tension # 1



Ribbon Supply Spindle
Tension # 1



For 3" width ribbon

If the ribbon width is 3", adjust both ribbon tension adjustment knobs to the #2 on ribbon supply & rewind spindles.

Ribbon Rewind Spindle
Tension # 2



Ribbon Supply Spindle
Tension # 2



For 2" width ribbon

If the ribbon width is 2", adjust both ribbon tension adjustment knobs to the #3 on ribbon supply & rewind spindles.

Ribbon Rewind Spindle
Tension # 3



Ribbon Supply Spindle
Tension # 3



6. Diagnostic Tool

TSC's Diagnostic Utility is an integrated tool incorporating features that enable you to explore a printer's settings/status; change a printer's settings; download graphics, fonts and firmware; create a printer bitmap font; and send additional commands to a printer. With the aid of this powerful tool, you can review printer status and setting in an instant, which makes it much easier to troubleshoot problems and other issues.

6.1 Start the Diagnostic Tool

1. Double click on the Diagnostic tool icon  `DiagTool.exe` to start the software.
2. There are four features (Printer Configuration, File Manager, Bitmap Font Manager, Command Tool) included in the Diagnostic utility.

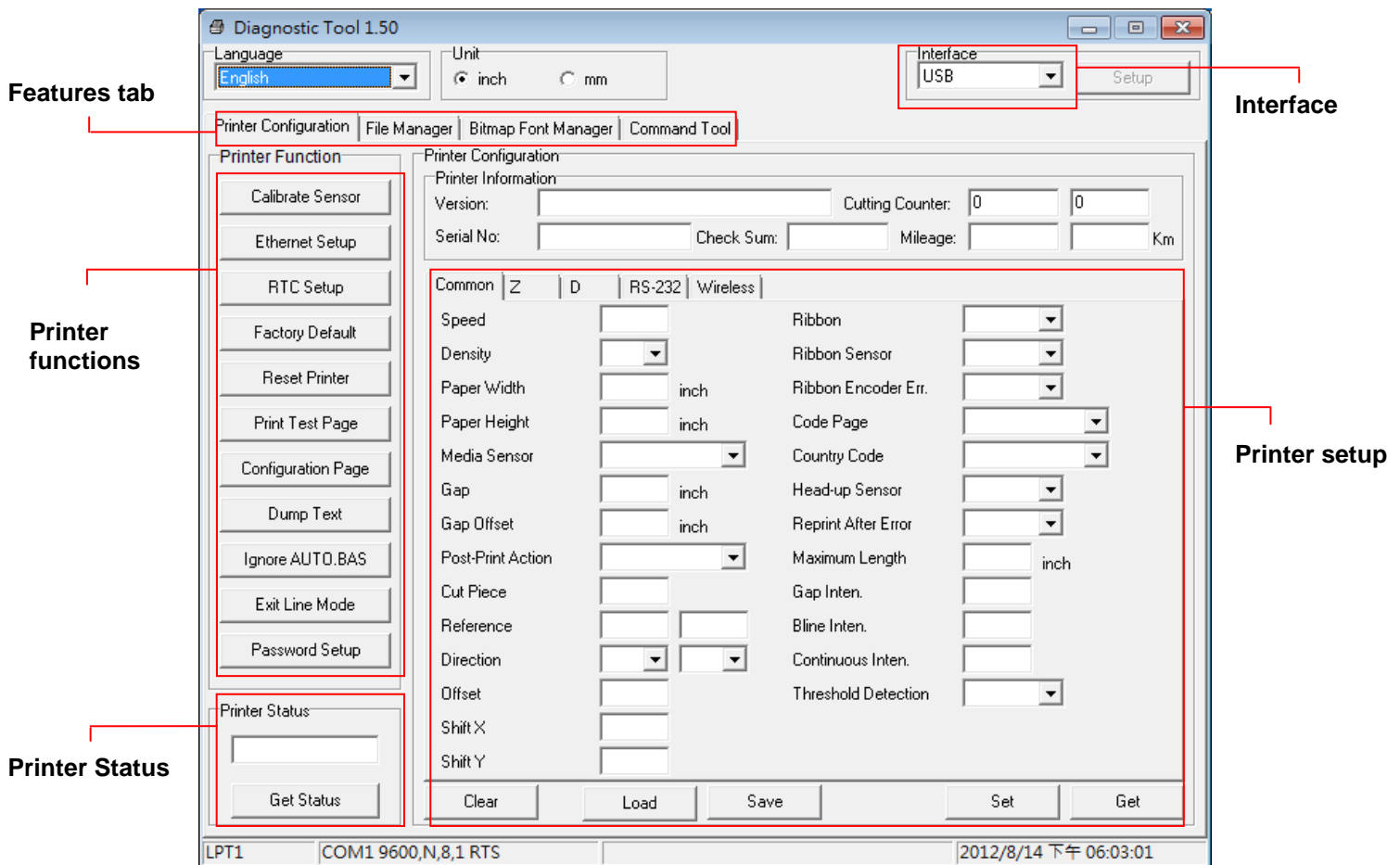

6.2 Printer Function

1. Connect the printer and computer with a cable.
2. Select the PC interface connected with bar code printer.

USB cable	Other cable
Interface USB <input type="button" value="Setup"/>	Interface COM <input type="button" value="Setup"/> 2 USB COM 1 LPT ETHERNET
The default interface setting is USB interface. If USB interface is connected with printer, no other settings need to be changed in the interface field.	

3. Click the “Printer Function” button to setup.
4. The detail functions in the Printer Function Group are listed as below.

Printer Function	Function	Description
<input type="button" value="Calibrate Sensor"/>	Calibrate Sensor	Calibrate the sensor specified in the Printer Setup group media sensor field
<input type="button" value="Ethernet Setup"/>	Ethernet Setup	Setup the IP address, subnet mask, gateway for the on board Ethernet
<input type="button" value="RTC Setup"/>	RTC Setup	Synchronize printer Real Time Clock with PC
<input type="button" value="Factory Default"/>	Factory Default	Initialize the printer and restore the settings to factory default.
<input type="button" value="Reset Printer"/>	Reset Printer	Reboot printer
<input type="button" value="Print Test Page"/>	Print Test Page	Print a test page
<input type="button" value="Configuration Page"/>	Configuration Page	Print printer configuration
<input type="button" value="Dump Text"/>	Dump Text	To activate the printer dump mode.
<input type="button" value="Ignore AUTO.BAS"/>	Ignore AUTO.BAS	Ignore the downloaded AUTO.BAS program
<input type="button" value="Exit Line Mode"/>	Exit Line Mode	Exit line mode.
<input type="button" value="Password Setup"/>	Password Setup	Set the password to protect the settings

For more information about Diagnostic Tool, please refer to the diagnostic utility quick start guide in the CD disk \ Utilities directory.

6.3 Setting Ethernet by Diagnostic Tool

The Diagnostic Utility is enclosed in the CD disk \Utilities directory. Users can use Diagnostic Tool to setup the Ethernet by RS-232, USB and Ethernet interfaces. The following contents will instruct users how to configure the Ethernet by these three interfaces.

6.3.1 Using USB interface to setup Ethernet interface

1. Connect the printer and computer with USB cable.
2. Turn on the printer power switch.
3. Start the Diagnostic Utility by double clicking on the  icon.
4. The Diagnostic Utility default interface setting is USB interface. If USB interface is connected with printer, no other settings need to be changed in the interface field.

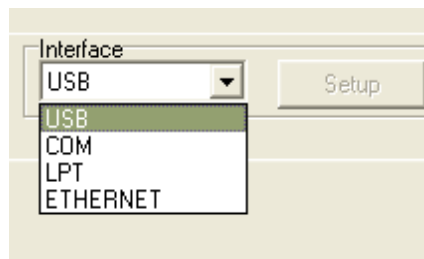

5. Click on the “Ethernet Setup” button from “Printer Function” group in Printer Configuration tab to setup the IP address, subnet mask and gateway for the on board Ethernet.

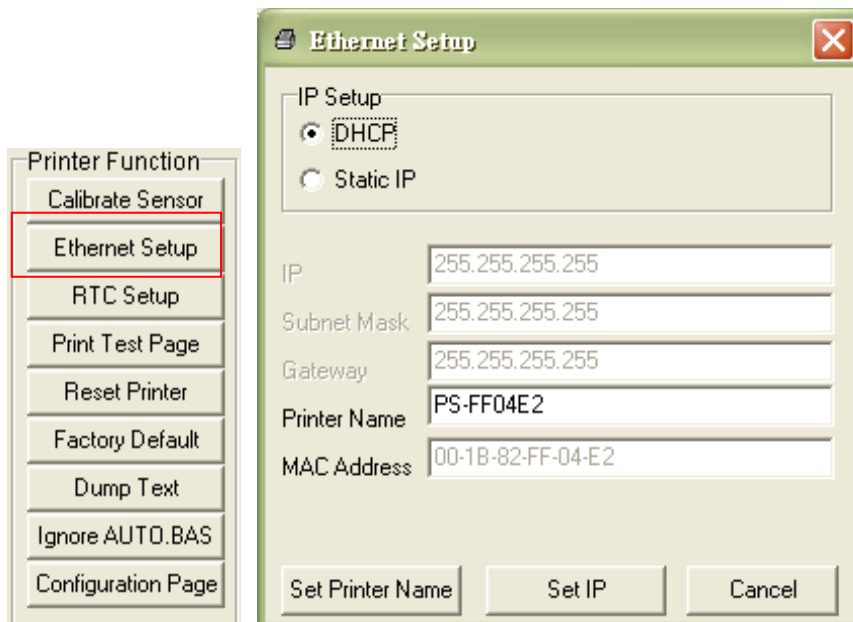

6.3.2 Using RS-232 interface to setup Ethernet interface

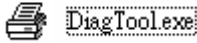
1. Connect the computer and the printer with a RS-232 cable.
2. Turn on the printer power.
3. Start the Diagnostic Utility by double clicks on the  icon.
4. Select “COM” as interface then click on the “Setup” button to setup the serial port baud rate, parity check, data bits, stop bit and flow control parameters.

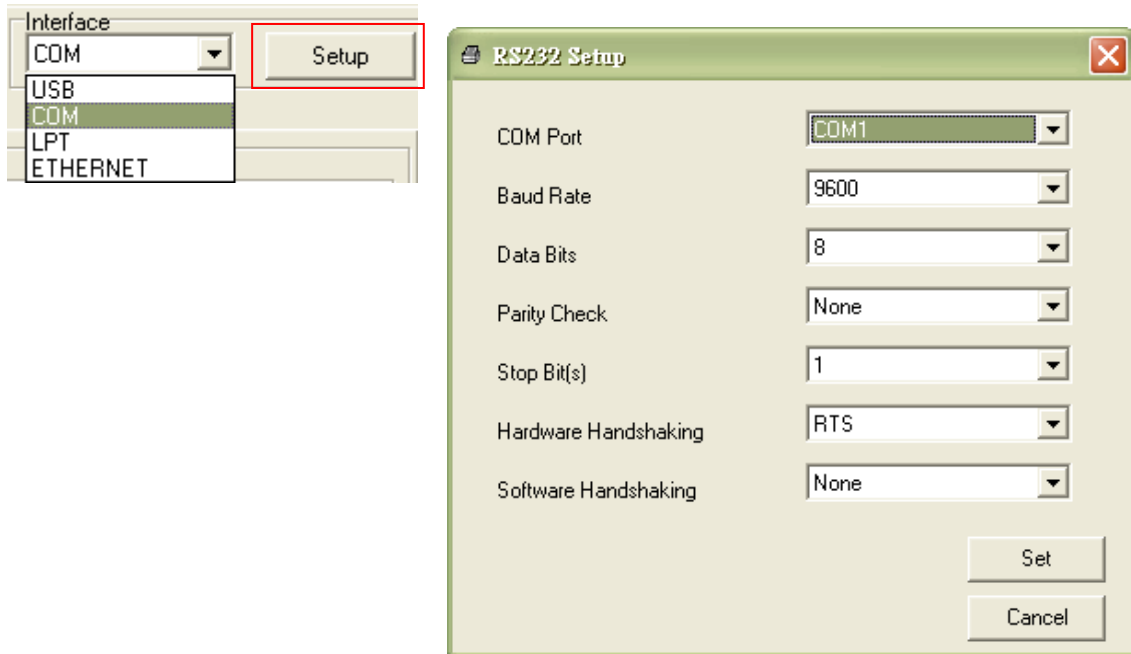

5. Click on the “Ethernet Setup” button from printer function of Printer Configuration tab to setup the IP address, subnet mask and the gateway for the on board Ethernet.

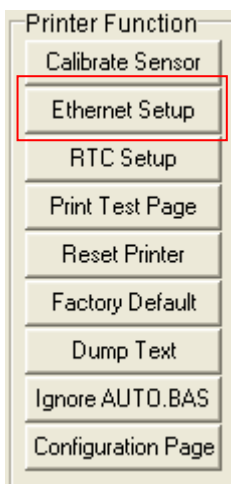

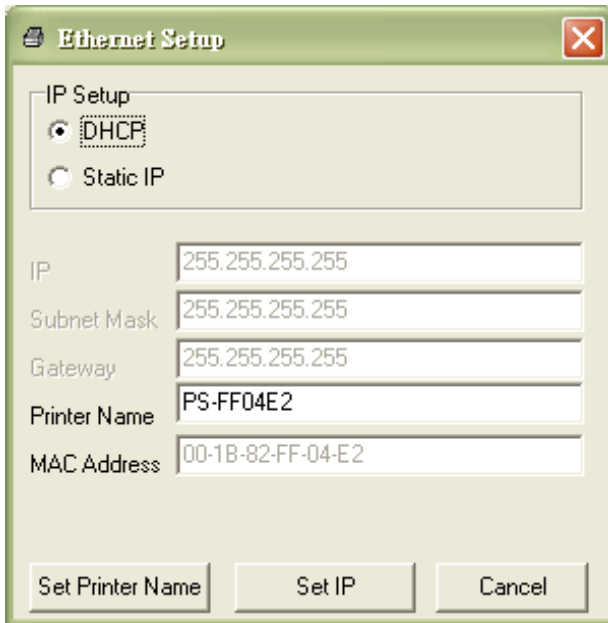

6.3.3 Using Ethernet interface to setup Ethernet interface

1. Connect the computer and the printer to the LAN.
2. Turn on the printer power.
3. Start the Diagnostic Utility by double clicks on the  `DiagTool.exe` icon.
4. Select “Ethernet” as the interface then click on the “Setup” button to setup the IP address, subnet mask and gateway for the on board Ethernet.

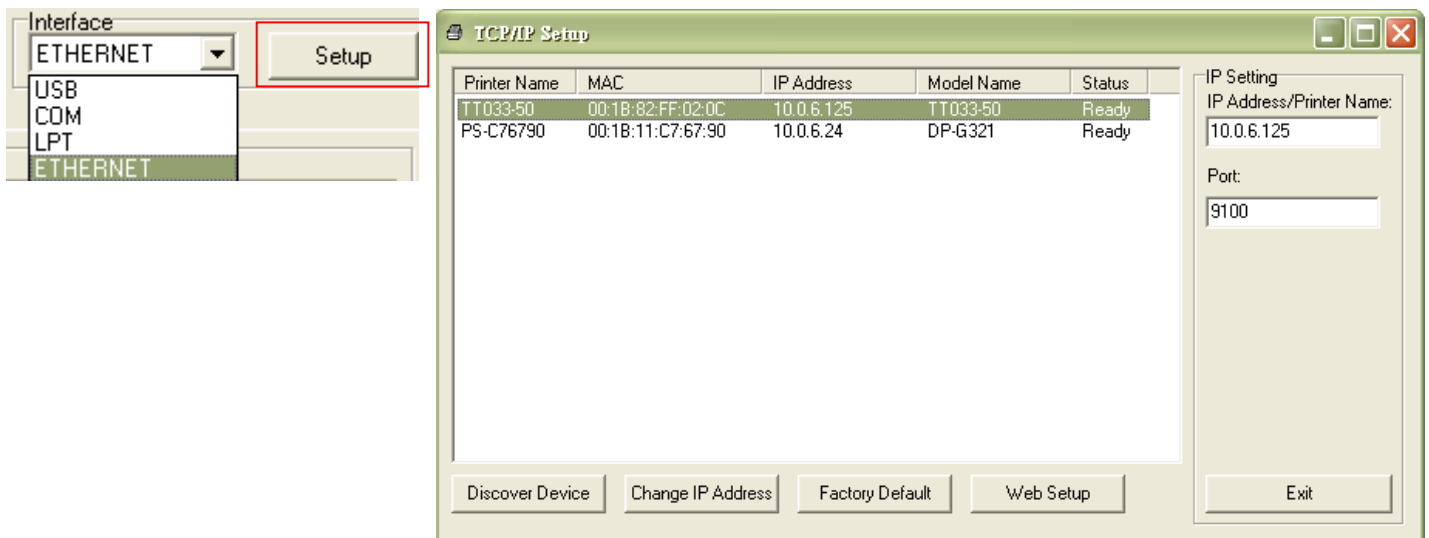

5. Click the “Discover Device” button to explore the printers that exist on the network.

6. Select the printer in the left side of listed printers, the correspondent IP address will be shown in the right side "IP address/Printer Name" field.
7. Click "Change IP Address" to configure the IP address obtained by DHCP or static.

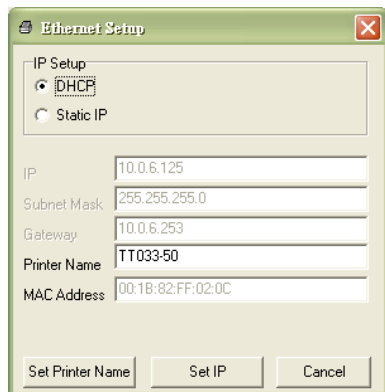

The default IP address is obtained by DHCP. To change the setting to static IP address, click "Static IP" radio button then enter the IP address, subnet mask and gateway. Click "Set IP" to take effect the settings.

Users can also change the "Printer Name" by another model name in this fields then click "Set Printer Name" to take effect this change.

Note: After clicking the "Set Printer Name" or "Set IP" button, printer will reset to take effect the settings.

8. Click "Exit" button to exit the Ethernet interface setup and go back to Diagnostic Tool main screen.

Factory Default button

This function will reset the IP, subnet mask, gateway parameters obtained by DHCP and reset the printer name.

Web setup button

Except to use the Diagnostic Utility to setup the printer, you can also explore and configure the printer settings and status or update the firmware with the IE or Firefox web browser. This feature provides a user friendly setup interface and the capability to manage the printer remotely over a network.

7. LCD Menu Function

7.1 Enter the Menu

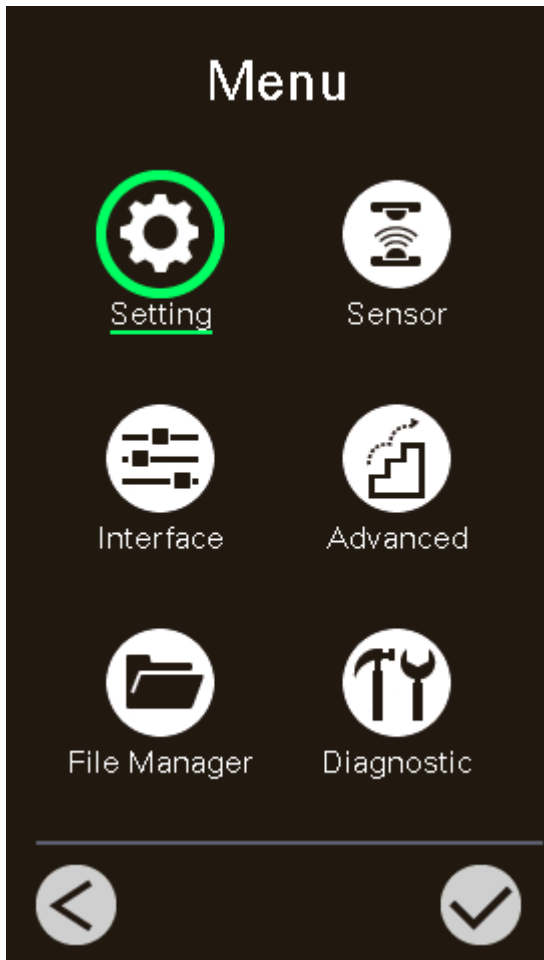

* By touch display:

Tap the  "Menu" icon on LCD main page to enter the menu.

* By Keys:

Use navigational keys to select the

 "Menu" icon (be marked in green) and press the left soft key

button (means ) to enter the menu.

7.2 Menu Overview

There are 6 categories for the menu. You can easily set the settings of printer without connecting the computer. Please refer to following sections for more details.



This "Setting" category can set up the printer settings for TSPL & ZPL2.



This "Sensor" option is used to calibrate the selected media sensor. We recommend calibrate the sensor before printing when changing the media.

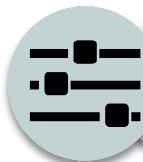

This "Interface" option is used to set the printer interface settings.



This "Advanced" option is used to set the printer LCD settings, initialization, cutter type, media low warning setting %...etc.



This "File Manager" option is used to check/manager the printer available memory.



This "Diagnostic" option is used to review printer to troubleshoot problems and other issues.

7.3 Setting

Tap the “Command Set” item on LCD to switch the TSPL and ZPL2. Or select the “Command Set” item by navigational key and press right soft key to switch the TSPL and ZPL2.

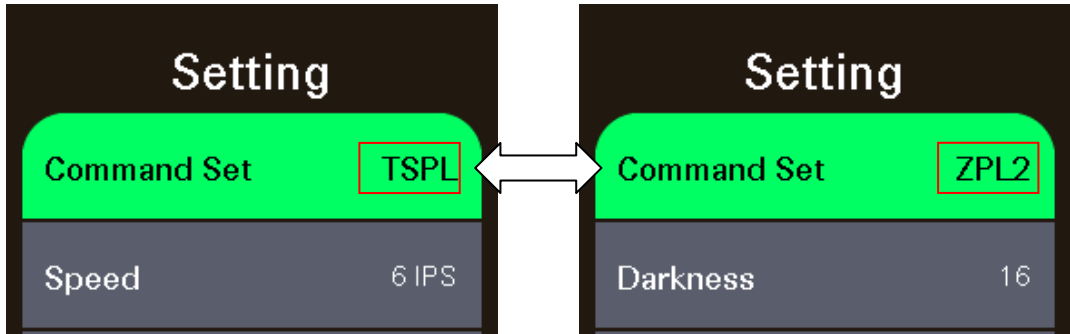

7.3.1 TSPL

This “TSPL” category can set up the printer settings for TSPL.

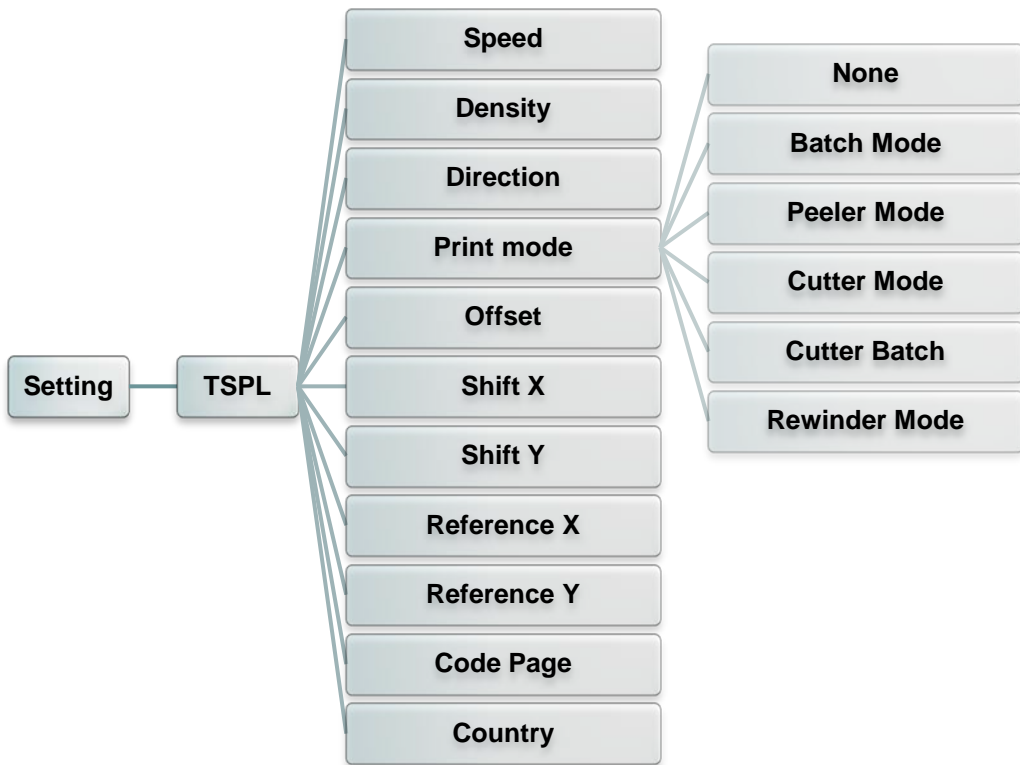

Item	Description	Default
Speed	Use this item to setup print speed. Available setting range is 2~18 for 203dpi, 2~14 for 300dpi and 1.5 ~6 for 600dpi.	203 dpi: 6 300 dpi: 4 600 dpi: 3
Density	Use this option to setup printing darkness. The available setting range is from 0 to 15, and the step is 1. You may need to adjust your density based on selected media.	8

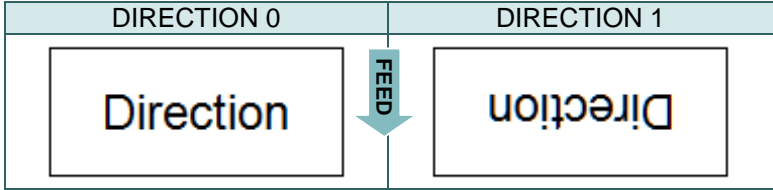
Direction	<p>The direction setting value is either 1 or 0. Use this item to setup the printout direction.</p> 	0														
Print mode	<p>This item is used to set the print mode. There are 6 modes as below,</p> <table border="1" data-bbox="448 542 1294 904"> <thead> <tr> <th>Printer Mode</th> <th>Description</th> </tr> </thead> <tbody> <tr> <td>None</td> <td>Next label top of form is aligned to the print head burn line location. (Tear Off Mode)</td> </tr> <tr> <td>Batch Mode</td> <td>Once image is printed completely, label gap/black mark will be fed to the tear plate location for tear away.</td> </tr> <tr> <td>Peeler Mode</td> <td>Enable the label peel off mode.</td> </tr> <tr> <td>Cutter Mode</td> <td>Enable the label cutter mode.</td> </tr> <tr> <td>Cutter Batch</td> <td>Cut the label once at the end of the printing job.</td> </tr> <tr> <td>Rewinder Mode</td> <td>Enable the label rewinder mode.</td> </tr> </tbody> </table>	Printer Mode	Description	None	Next label top of form is aligned to the print head burn line location. (Tear Off Mode)	Batch Mode	Once image is printed completely, label gap/black mark will be fed to the tear plate location for tear away.	Peeler Mode	Enable the label peel off mode.	Cutter Mode	Enable the label cutter mode.	Cutter Batch	Cut the label once at the end of the printing job.	Rewinder Mode	Enable the label rewinder mode.	Batch Mode
Printer Mode	Description															
None	Next label top of form is aligned to the print head burn line location. (Tear Off Mode)															
Batch Mode	Once image is printed completely, label gap/black mark will be fed to the tear plate location for tear away.															
Peeler Mode	Enable the label peel off mode.															
Cutter Mode	Enable the label cutter mode.															
Cutter Batch	Cut the label once at the end of the printing job.															
Rewinder Mode	Enable the label rewinder mode.															
Offset	This item is used to fine tune media stop location. Available setting value range is from -999 dots to 999 dots.	0 dot														
Shift X	This item is used to fine tune print position. Available setting value range is from -999 dots to 999 dots.	0 dot														
Shift Y		0 dot														
Reference X	This item is used to set the origin of printer coordinate system horizontally and vertically. Available setting range is from 0 dot to 999 dots.	0 dot														
Reference Y		0 dot														
Code page	Use this item to set the code page of international character set.	850														
Country	Use this option to set the country code. Available setting value range is from 1 to 358.	001														

Note: If printing from enclosed software/driver, the software/driver will send out the commands, which will overwrite the settings set from the panel.

7.3.2 ZPL2

This “ZPL2” category can set up the printer settings for ZPL2.

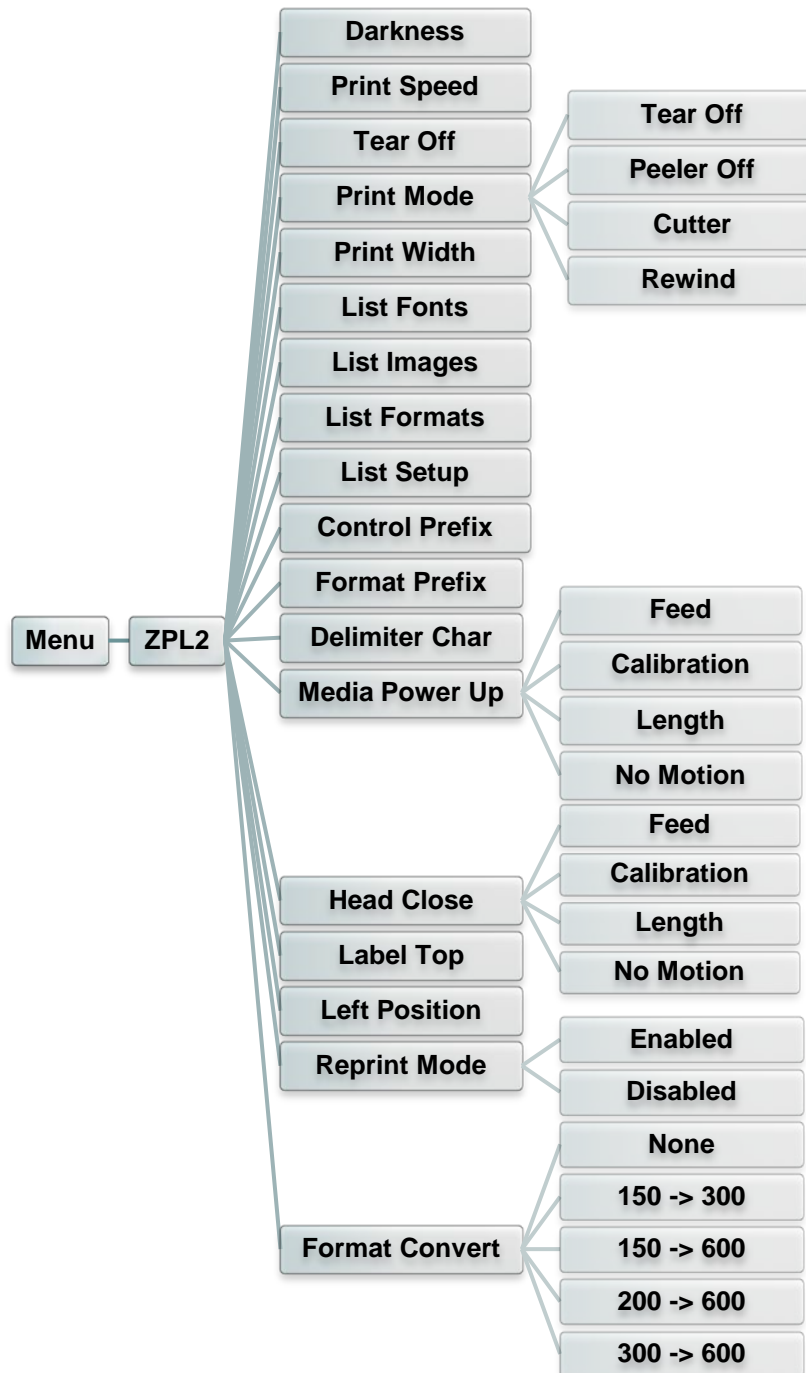

Item	Description	Default
Density	Use this item to setup printing darkness. The available setting range is from 0 to 30. You may need to adjust your density based on selected media.	16
Print Speed	Use this item to setup print speed. Available setting range is 2~18 for 203dpi, 2~14 for 300dpi and 1.5 ~6 for 600dpi.	203 dpi: 6 300 dpi: 4 600 dpi: 3

Tear Off	This item is used to fine tune media stop location. Available setting value range is from -120~120 dots.	0 dot										
Print mode	<p>This item is used to set the print mode. There are 3 modes as below,</p> <table border="1"> <thead> <tr> <th>Printer Mode</th> <th>Description</th> </tr> </thead> <tbody> <tr> <td>Tear Off</td> <td>Next label top of form is aligned to the print head burn line location.</td> </tr> <tr> <td>Peeler Off</td> <td>Enable the label peel off mode.</td> </tr> <tr> <td>Cutter</td> <td>Enable the label cutter mode</td> </tr> <tr> <td>Rewind</td> <td>Enable the label rewind mode</td> </tr> </tbody> </table>	Printer Mode	Description	Tear Off	Next label top of form is aligned to the print head burn line location.	Peeler Off	Enable the label peel off mode.	Cutter	Enable the label cutter mode	Rewind	Enable the label rewind mode	Tear Off
Printer Mode	Description											
Tear Off	Next label top of form is aligned to the print head burn line location.											
Peeler Off	Enable the label peel off mode.											
Cutter	Enable the label cutter mode											
Rewind	Enable the label rewind mode											
Print Width	This item is used to set print width. The available value range is 2 ~ 999 dots.	812										
List Fonts	This feature is used to print current printer available fonts list to the label. The fonts stored in the printer's DRAM, Flash or optional memory card.	N/A										
List Images	This feature is used to print current printer available images list to the label. The images stored in the printer's DRAM, Flash or optional memory card.	N/A										
List Formats	This feature is used to print current printer available formats list to the label. The formats stored in the printer's DRAM, Flash or optional memory card.	N/A										
List Setup	This feature is used to print current printer configuration to the label.	N/A										
Control Prefix	This feature is used to set control prefix character.	N/A										
Format Prefix	This feature is used to set format prefix character.	N/A										
Delimiter Char	This feature is used to set delimiter character.	N/A										
Media Power Up	<p>This option is used to set the action of the media when you turn on the printer.</p> <table border="1"> <thead> <tr> <th>Selections</th> <th>Description</th> </tr> </thead> <tbody> <tr> <td>Feed</td> <td>Printer will advance one label</td> </tr> <tr> <td>Calibration</td> <td>Printer will calibration the sensor levels, determine length and feed label</td> </tr> <tr> <td>Length</td> <td>Printer determine length and feed label</td> </tr> <tr> <td>No Motion</td> <td>Printer will not move media</td> </tr> </tbody> </table>	Selections	Description	Feed	Printer will advance one label	Calibration	Printer will calibration the sensor levels, determine length and feed label	Length	Printer determine length and feed label	No Motion	Printer will not move media	No Motion
Selections	Description											
Feed	Printer will advance one label											
Calibration	Printer will calibration the sensor levels, determine length and feed label											
Length	Printer determine length and feed label											
No Motion	Printer will not move media											
Head Close	<p>This option is used to set the action of the media when you close the print head.</p> <table border="1"> <thead> <tr> <th>Selections</th> <th>Description</th> </tr> </thead> <tbody> <tr> <td>Feed</td> <td>Printer will advance one label</td> </tr> <tr> <td>Calibration</td> <td>Printer will calibration the sensor levels, determine length and feed label</td> </tr> <tr> <td>Length</td> <td>Printer determine length and feed label</td> </tr> <tr> <td>No Motion</td> <td>Printer will not move media</td> </tr> </tbody> </table>	Selections	Description	Feed	Printer will advance one label	Calibration	Printer will calibration the sensor levels, determine length and feed label	Length	Printer determine length and feed label	No Motion	Printer will not move media	No Motion
Selections	Description											
Feed	Printer will advance one label											
Calibration	Printer will calibration the sensor levels, determine length and feed label											
Length	Printer determine length and feed label											
No Motion	Printer will not move media											
Label Top	This option is used to adjust print position vertically on the label. The range is -120 to +120 dots.	0										
Left Position	This option is used to adjust print position horizontally on the label. The range is -9999 to +9999 dots.	0										
Reprint Mode	When reprint mode is enabled, you can reprint the last label printer by pressing  button on printer's control panel.	Disabled										
Format Convert	Selects the bitmap scaling factor. The first number is the original dots per inch (dpi) value; the second, the dpi to which	None										

	you would like to scale.	
--	--------------------------	--

Note: If printing from enclosed software/driver, the software/driver will send out the commands, which will overwrite the settings set from the panel.

7.4 Sensor

This option is used to calibrate the selected sensor. We recommend calibrate the sensor before printing when changing the media.

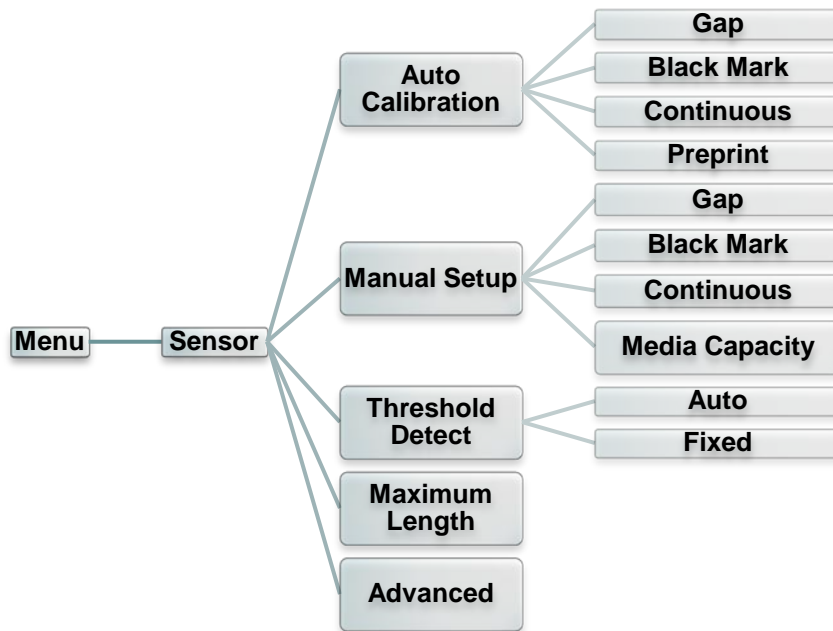

Item	Description	Default
Auto Calibration	This option is used to set the media sensor type and calibrate the selected sensor automatically. Printer will feed 2 to 3 gap labels to calibrate the sensor sensitivity automatically.	N/A
Manual setup	In case “Automatic” cannot apply to the media, please use “Manual” function to set the paper length and gap/bline size then scan the backing/mark to calibrate the sensor sensitivity. Note: The “Media Capacity” item is used to calibrate the media capacity sensor %.	N/A
Threshold Detect	This option is used to set sensor sensitivity in fixed or auto.	Auto
Maximum Length	This option is used to set the maximum length for label calibration.	254 mm
Advanced	This function can set the minimum paper length and maximum gap/bline length for auto-calibrate the sensor sensitivity.	0 mm

7.5 Interface

This option is used to set the printer interface settings.

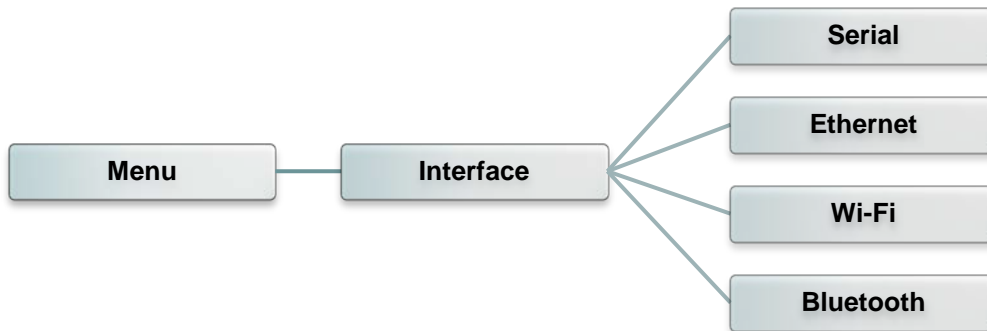

7.5.1 Serial Comm.

This option is used to set the printer RS-232 settings.

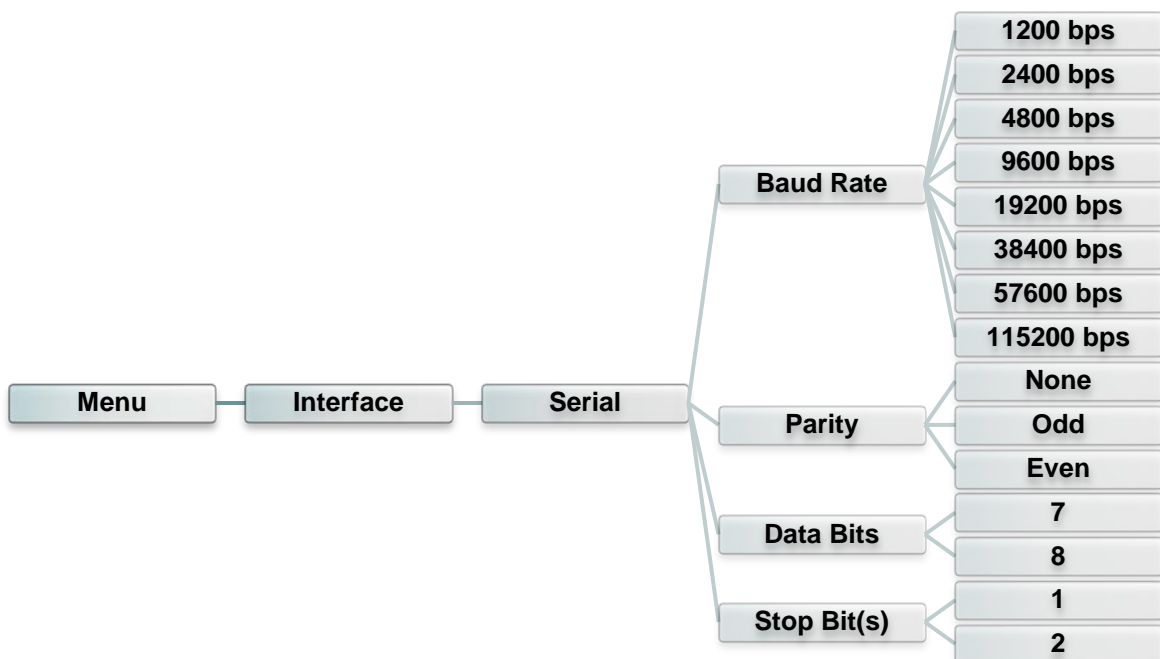

Item	Description	Default
Baud Rate	This item is used to set the RS-232 baud rate.	9600
Parity	This item is used to set the RS-232 parity.	None
Data Bits	This item is used to set the RS-232 Data Bits.	8
Stop Bit(s)	This item is used to set the RS-232 Stop Bits.	1

7.5.2 Ethernet

Use this menu to configure internal Ethernet configuration check the printer's Ethernet module status, and reset the Ethernet module.

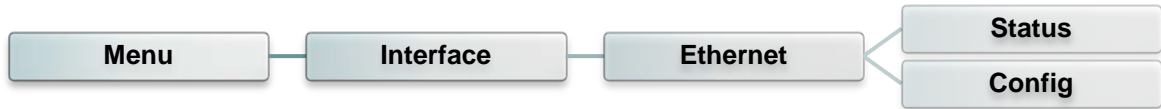

Item	Description	Default
Status	Use this menu to check the Ethernet IP address and MAC setting status.	N/A
Config	DHCP: This item is used to ON or OFF the DHCP (Dynamic Host Configuration Protocol) network protocol. Static IP: Use this menu to set the printer's IP address, subnet mask and gateway.	DHCP

7.5.3 Wi-Fi

This option is used to set the printer Wi-Fi settings.

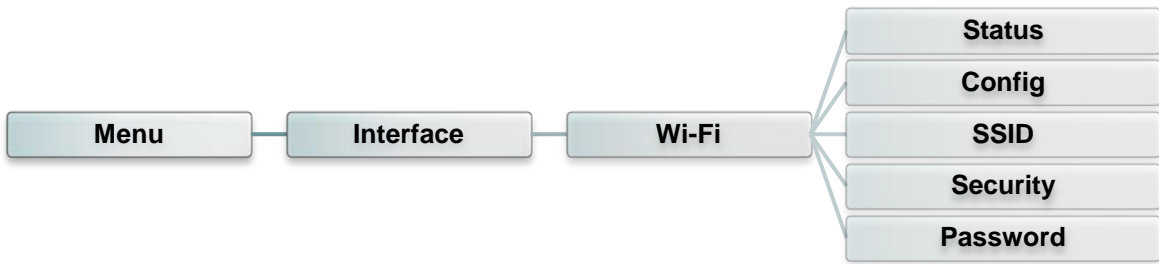

Item	Description	Default
Status	Use this menu to check the Wi-Fi IP address, MAC setting status....	N/A
Config	<p>DHCP: This item is used to ON or OFF the DHCP (Dynamic Host Configuration Protocol) network protocol.</p> <p>Static IP: Use this menu to set the printer's IP address, subnet mask and gateway.</p>	DHCP
SSID	Use this menu to set the Wi-Fi SSID	N/A
Security	Use this menu to set the Wi-Fi security	Open
Password	Use this menu to set the Wi-Fi password	N/A

7.5.4 Bluetooth

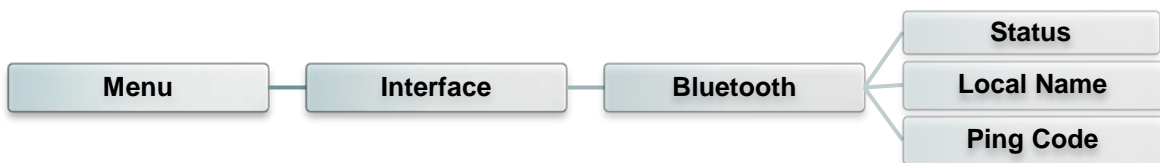

This option is used to set the printer Bluetooth settings.

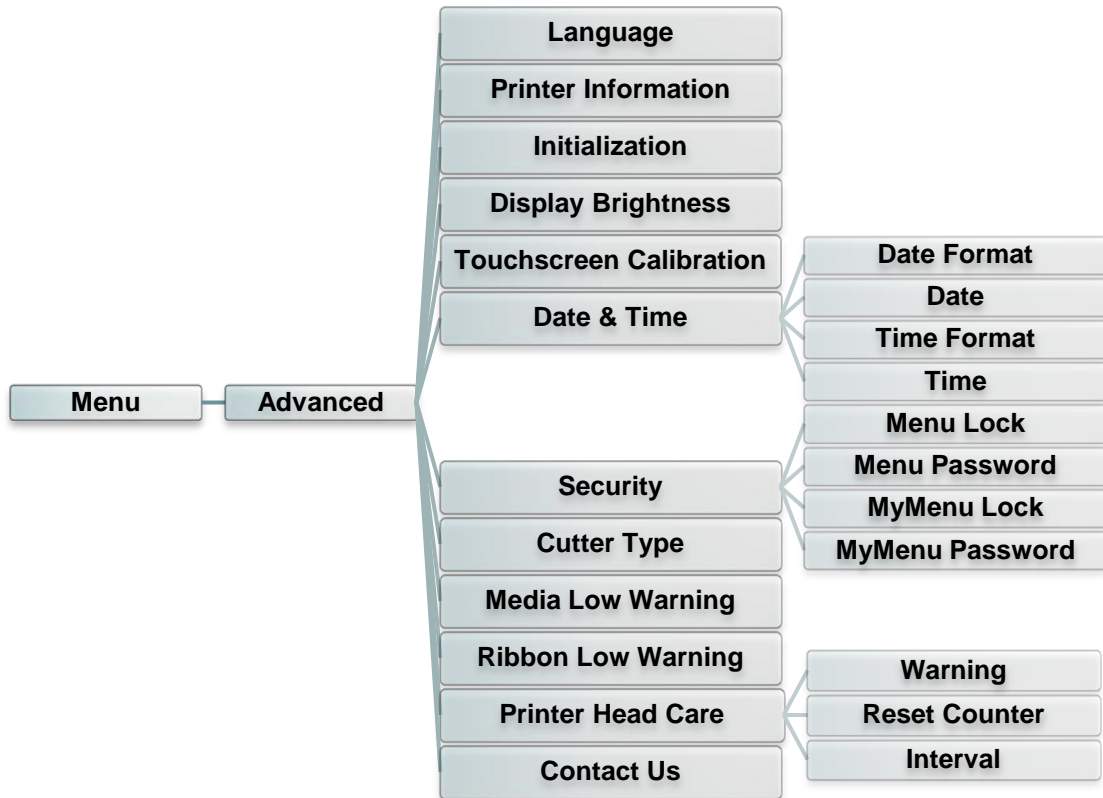

Item	Description	Default
Status	Use this menu to check the Bluetooth status.	N/A
Local Name	This item is used to set the local name for Bluetooth.	RF-BHS
Ping Code	This item is used to set the local ping code for Bluetooth.	0000

7.6 Advanced



Item	Description	Default
Language	This item is used to setup the language on display.	English
Printer Information	This feature is used to check the printer serial number, printed mileage (m), printed labels (pcs) and cutting counter.	N/A
Initialization	This feature is used to restore printer settings to defaults.	N/A
Display Brightness	This item is used to setup the brightness for display. (Range 0~100)	50
Touchscreen Calibration	This feature is used to calibrate the touchscreen for best result.	N/A
Date & Time	This item is used to setup the date and time on display.	N/A
Security	This feature is used to set the password for locking the menu or favorites. The default password is 8888.	Disable
Cutter Type	This item is used to set the cutter type.	Guillotine
Media Low Warning	This item is used to set the warning for media low %. For example, if setting value is 10%, when media capacity was lower than 10%, the  % will be shown in red.	10%
Ribbon Low Warning	This item is used to set the warning for ribbon low %. For example, if setting value is 10%, when ribbon capacity was lower than 10%, the  % will be shown in red.	10%

Printer Head Care	This item is used to check print head status and to set the settings for print head care.	N/A								
	<table border="1"> <thead> <tr> <th>Item</th> <th>Description</th> </tr> </thead> <tbody> <tr> <td>Warning</td> <td>This item is used to enable/disable the print head clean warning. If enable this feature, once print head has been reached the setting mileage then the warning icon will be shown on printer UI for reminding user to clean the print head. The default setting is disable.</td> </tr> <tr> <td>Reset Counter</td> <td>This item is used to reset the print head clean warning mileage after cleaned print head.</td> </tr> <tr> <td>Interval</td> <td>This item is used to set the expected mileage for reminding user to clean the print head. You have to enable the "TPH warning lock" for use. The default setting is 1 km.</td> </tr> </tbody> </table>		Item	Description	Warning	This item is used to enable/disable the print head clean warning. If enable this feature, once print head has been reached the setting mileage then the warning icon will be shown on printer UI for reminding user to clean the print head. The default setting is disable.	Reset Counter	This item is used to reset the print head clean warning mileage after cleaned print head.	Interval	This item is used to set the expected mileage for reminding user to clean the print head. You have to enable the "TPH warning lock" for use. The default setting is 1 km.
	Item		Description							
	Warning		This item is used to enable/disable the print head clean warning. If enable this feature, once print head has been reached the setting mileage then the warning icon will be shown on printer UI for reminding user to clean the print head. The default setting is disable.							
Reset Counter	This item is used to reset the print head clean warning mileage after cleaned print head.									
Interval	This item is used to set the expected mileage for reminding user to clean the print head. You have to enable the "TPH warning lock" for use. The default setting is 1 km.									
Contact us	This feature is used to check the contact information for tech support service	N/A								

7.7 File Manager

This feature is used to check the printer available memory, show the files list, delete the files or run the files that saved in the printer DRAM/Flash/Card memory.



7.8 Diagnostic

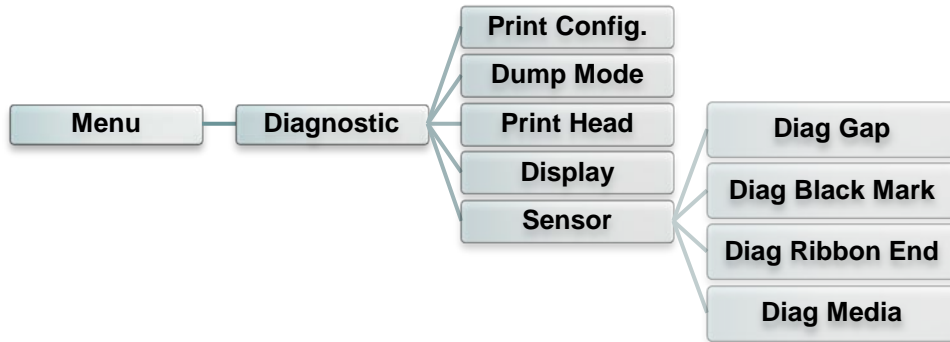

Item	Description
Print Config.	<p>This feature is used to print current printer configuration to the label. On the configuration printout, there is a print head test pattern, which is useful for checking if there is any dot damage on the print head heater element.</p> <div data-bbox="550 745 1369 2009" style="border: 1px solid black; padding: 10px;"> <p style="text-align: center;">Self-test printout</p> <pre> ----- SYSTEM INFORMATION ----- MODEL: XXXXXX FIRMWARE: X.XX CHECKSUM: XXXXXXXX S/N: XXXXXXXXXXXX TCF: NO DATE: 1970/01/01 TIME: 00:04:18 NON-RESET: 110 m (TPH) RESET: 110 m (TPH) NON-RESET: 0 (CUT) RESET: 0 (CUT) ----- PRINTING SETTING ----- SPEED: 5 IPS DENSITY: 8.0 WIDTH: 4.00 INCH HEIGHT: 4.00 INCH GAP: 0.00 INCH INTENSION: 5 CODEPAGE: 850 COUNTRY: 001 ----- Z SETTING ----- DARKNESS: 16.0 SPEED: 4 IPS WIDTH: 4.00 INCH TILDE: 7EH (~) CARET: 5EH (^) DELIMITER: 2CH (,) POWER UP: NO MOTION HEAD CLOSE: NO MOTION ----- RS232 SETTING ----- BAUD: 9600 PARITY: NONE DATA BIT: 8 STOP BIT: 1 ----- </pre> <p style="text-align: right;">Note: ZPL is emulating for Zebra® language.</p> </div>

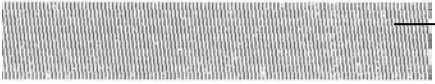
	<div style="border: 1px solid black; padding: 10px;"> <pre> ----- DRAM FILE (0 FILES) ----- PHYSICAL XXXX KBYTES AVAILABLE XXXX KBYTES ----- FLASH FILE (0 FILES) ----- PHYSICAL XXXX KBYTES AVAILABLE XXXX KBYTES ----- </pre>  <p>Numbers of download files Total & available memory space</p> <p>Print head check pattern</p> <p>Note: Checking dot damage requires 4" wide paper width.</p> </div>
<p>Dump Mode</p>	<p>Captures the data from the communications port and prints out the data received by printer. In the dump mode, all characters will be printed in 2 columns. The left side characters are received from your system and right side data are the corresponding hexadecimal value of the characters. It allows users or engineers to verify and debug the program.</p> <div style="border: 1px solid black; padding: 10px; margin: 10px 0;"> <pre> DOWNLOA 0D 0A 44 4F 57 4E 4C 4F 4I D „TEST2. 44 20 22 54 45 53 54 32 2E DAT“,5,CL 44 41 54 22 2C 35 2C 43 4C S DOWNLO 53 0D 0A 44 4F 57 4E 4C 4F AD F,„TES 41 44 20 46 2C 22 54 45 53 T4.DAT“,5 54 34 2E 44 41 54 22 2C 35 ,CLS DOW 2C 43 4C 53 0D 0A 44 4F 57 NLOAD „TE 4E 4C 4F 41 44 20 22 54 45 ST2.DAT“, 53 54 32 2E 44 41 54 22 2C 5,CLS DO 35 2C 43 4C 53 0D 0A 44 4F WNLOAD F, 57 4E 4C 4F 41 44 20 46 2C „TEST4.DA 22 54 45 53 54 34 2E 44 41 T“,5,CLS 54 22 2C 35 2C 43 4C 53 0D DOWNLOAD 0A 44 4F 57 4E 4C 4F 41 44 „TEST2.D 20 22 54 45 53 54 32 2E 44 AT“,5,CLS 41 54 22 2C 35 2C 43 4C 53 DOWNLOAD 0D 0A 44 4F 57 4E 4C 4F 4I D F,„TEST 44 20 46 2C 22 54 45 53 54 4.DAT“,5, 34 2E 44 41 54 22 2C 35 2C CLS 43 4C 53 0D 0A </pre> </div> <p>ASCII Data ←</p> <p>Hexadecimal data related to left column of ASCII data</p> <p>Note: Dump mode requires 4" wide paper width.</p>
<p>Print Head</p>	<p>This feature is used to check print head's temperature and bad dots.</p>
<p>Display</p>	<p>This feature is used to check LCD's color state.</p>
<p>Sensor</p>	<p>This feature is used to check sensors intensity and reading state.</p>

7.9 Favorites

This feature can create customized menu list. You can organize the commonly used setting options in “Favorites”. 

- **Get organized “Favorites” list**

Touch and hold a favorite option item, unit “Join Favorites” setting screen pops up. Tap “Yes” to add this setting option item to “Favorites” list.

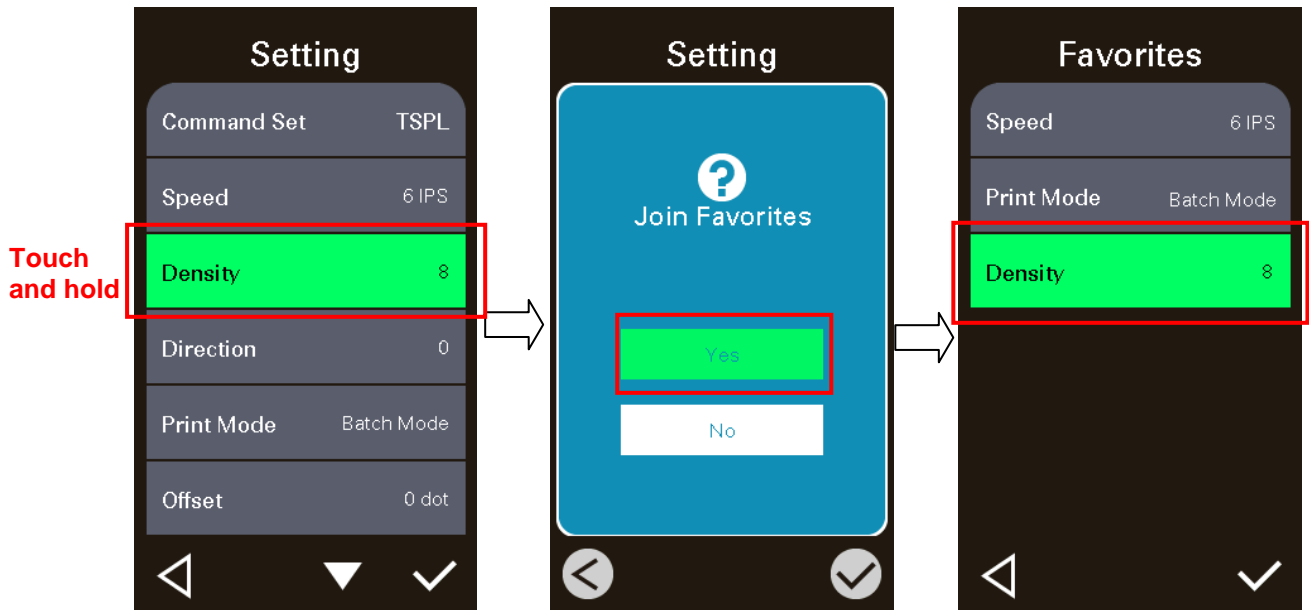

- **Delete option item**

Touch and hold the option item, unit “Delete Favorites” setting screen pops up. Tap “Yes” to delete this setting option item on “Favorites” list.

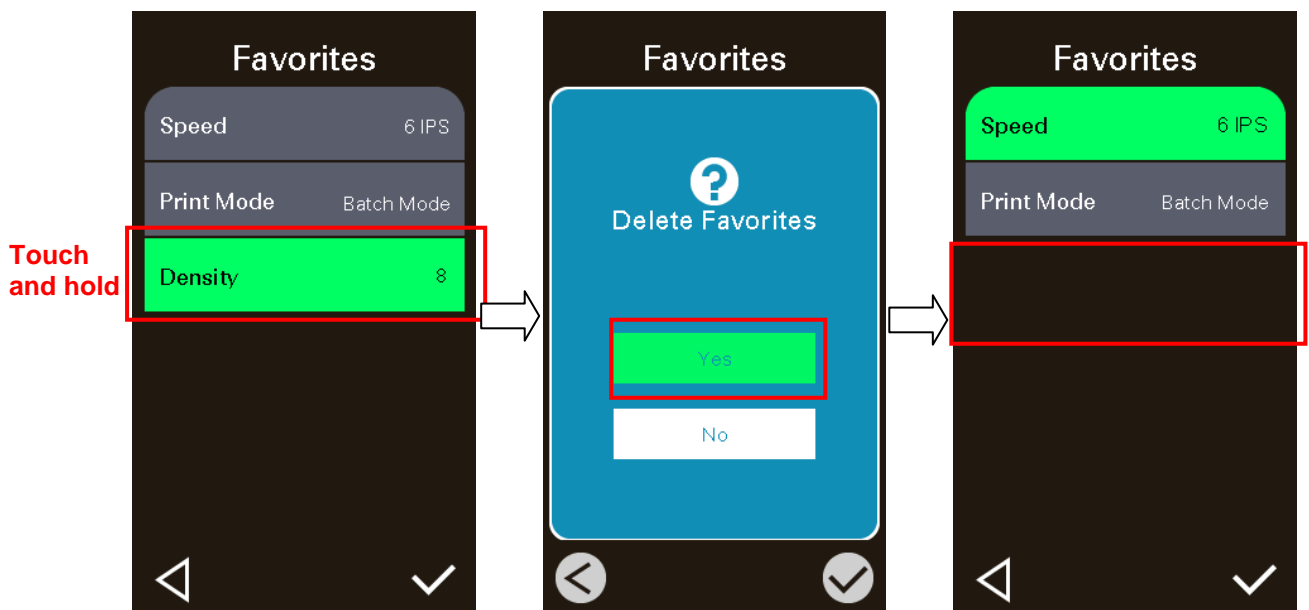

8 Troubleshooting

The following guide lists the most common problems that may be encountered when operating this bar code printer. If the printer still does not function after all suggested solutions have been invoked, please contact the Customer Service Department of your purchased reseller or distributor for assistance.

Problem	Possible Cause	Recovery Procedure
Power indicator does not illuminate	* The power cord is not properly connected.	* Plug the power cord in printer and outlet. * Switch the printer on.
Carriage Open	* The printer carriages are open.	* Please close the print carriages.
Not Printing	* Check if interface cable is well connected to the interface connector. * Check if wireless or Bluetooth device is well connected between host and printer. * The port specified in the Windows driver is not correct.	* Re-connect cable to interface or change a new cable. * Please reset the wireless device setting. * Select the correct printer port in the driver. * Clean the printhead. * Printhead's harness connector is not well connected with printhead. Turn off the printer and plug the connector again. * Check your program if there is a command PRINT at the end of the file and there must have CRLF at the end of each command line.
No print on the label	* Label or ribbon is loaded not correctly. * Use wrong type paper or ribbon	* Follow the instructions in loading the media and ribbon. * Ribbon and media are not compatible. * Verify the ribbon-inked side. * The print density setting is incorrect.
No Ribbon	* Running out of ribbon. * The ribbon is installed incorrectly.	* Supply a new ribbon roll. * Please refer to the steps in user's manual to reinstall the ribbon.
No Paper	* Running out of label. * The label is installed incorrectly. * Gap/black mark sensor is not calibrated.	* Supply a new label roll. * Please refer to the steps in user's manual to reinstall the label roll. * Calibrate the gap/black mark sensor.
Paper Jam	* Gap/black mark sensor is not set properly. * Make sure label size is set properly. * Labels may be stuck inside the printer mechanism.	* Calibrate the media sensor. * Set media size correctly. * Remove the stuck label inside the printer mechanism.
Take Label	* Peel function is enabled.	* If the peeler module is installed, please remove the label. * If there is no peeler module in front of the printer, please switch off the printer and install it. * Check if the connector is plugging correctly.
Can't downloading the file to memory (FLASH / DRAM/CARD)	* The space of memory is full.	* Delete unused files in the memory.

SD card is unable to use	<ul style="list-style-type: none"> * SD card is damaged. * SD card doesn't insert correctly. * Use the non-approved SD card manufacturer. 	<ul style="list-style-type: none"> * Use the supported capacity SD card. * Insert the SD card again. * The supported SD card spec and the approved SD card manufacturers, please refer to section 2.2.3.
Poor Print Quality	<ul style="list-style-type: none"> * Ribbon and media is loaded incorrectly * Dust or adhesive accumulation on the print head. * Print density is not set properly. * Printhead element is damaged. * Ribbon and media are incompatible. * The printhead pressure is not set properly. 	<ul style="list-style-type: none"> * Reload the supply. * Clean the print head. * Clean the platen roller. * Adjust the print density and print speed. * Run printer self-test and check the print head test pattern if there is dot missing in the pattern. * Change proper ribbon or proper label media. * Adjust the printhead pressure adjustment knob. * The release lever does not latch the printhead properly.
Missing printing on the left or right side of label	<ul style="list-style-type: none"> * Wrong label size setup. 	<ul style="list-style-type: none"> * Set the correct label size.
Gray line on the blank label	<ul style="list-style-type: none"> * The print head is dirty. * The platen roller is dirty. 	<ul style="list-style-type: none"> * Clean the print head. * Clean the platen roller.
Irregular printing	<ul style="list-style-type: none"> * The printer is in Hex Dump mode. * The RS-232 setting is incorrect. 	<ul style="list-style-type: none"> * Turn off and on the printer to skip the dump mode. * Re-set the Rs-232 setting.
Label feeding is not stable (skew) when printing	<ul style="list-style-type: none"> * The media guide does not touch the edge of the media. 	<ul style="list-style-type: none"> * If the label is moving to the right side, please move the label guide to left. * If the label is moving to the left side, please move the label guide to right.
Skip labels when printing	<ul style="list-style-type: none"> * Label size is not specified properly. * Sensor sensitivity is not set properly. * The media sensor is covered with dust. 	<ul style="list-style-type: none"> * Check if label size is setup correctly. * Calibrate the sensor by Auto Gap or Manual Gap options. * Clear the GAP/Black mark sensor by blower.
Wrinkle Problem	<ul style="list-style-type: none"> * Printhead pressure is incorrect. * Ribbon installation is incorrect. * Media installation is incorrect. * Print density is incorrect. * Media feeding is incorrect. 	<ul style="list-style-type: none"> * Please refer to the next chapter. * Please set the suitable density to have good print quality. * Make sure the label guide touch the edge of the media guide.
RTC time is incorrect when reboot the printer	<ul style="list-style-type: none"> * The battery has run down. 	<ul style="list-style-type: none"> * Check if there is a battery on the main board.
The left side printout position is incorrect	<ul style="list-style-type: none"> * Wrong label size setup. * The parameter Shift X in LCD menu is incorrect. 	<ul style="list-style-type: none"> * Set the correct label size. * Press [MENU] → [SELECT] x 3 → [DOWN] x 5 → [SELECT] to fine tune the parameter of Shift X.

The printing position of small label is incorrect

- * Media sensor sensitivity is not set properly.
- * Label size is incorrect.
- * The parameter Shift Y in the LCD menu is incorrect.
- * The vertical offset setting in the driver is incorrect.

- * Calibrate the sensor sensitivity again.
- * Set the correct label size and gap size.
- * Press [MENU] → [SELECT] x3 → [DOWN] x6 → [SELECT] to fine tune the parameter of Shift Y.
- * If using the software BarTender, please set the vertical offset in the driver.

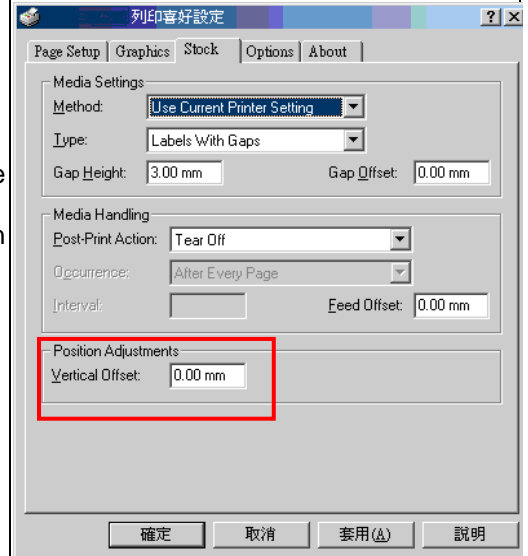

9 Maintenance

This session presents the clean tools and methods to maintain your printer.

1. Please use one of following material to clean the printer.

- Cotton swab
- Lint-free cloth
- Vacuum / Blower brush
- 100% Ethanol or Isopropyl Alcohol

2. The cleaning process is described as following,

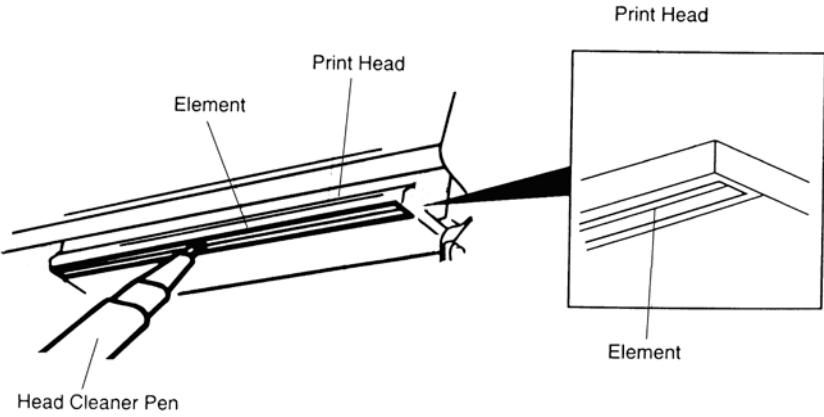
Printer Part	Method	Interval
Print Head	<ol style="list-style-type: none"> 1. Always turn off the printer before cleaning the print head. 2. Allow the print head to cool for a minimum of one minute. 3. Use a cotton swab and 100% Ethanol or Isopropyl Alcohol to clean the print head surface. 	Clean the print head when changing a new label roll.
		
Platen Roller	<ol style="list-style-type: none"> 1. Turn the power off. 2. Rotate the platen roller and wipe it thoroughly with water. 	Clean the platen roller when changing a new label roll
Peel Bar	Use the lint-free cloth with 100% ethanol to wipe it.	As needed
Sensor	Compressed air or vacuum	Monthly
Exterior	Wipe it with water-dampened cloth	As needed
Interior	Brush or vacuum	As needed

Note:

- Do not touch printer head by hand. If you touch it careless, please use ethanol to clean it.
- Please use 100% Ethenol or Isopropyl Alcohol. DO NOT use medical alcohol, which may damage the printer head.
- Regularly clean the print head and supply sensors once change a new media to keep printer performance and extend printer life.

Revise History

Date	Content	Editor
2016/06/22	Modify agency compliance section	Camille
2016/08/19	Add a note for Energy star (power saver mode)	Camille
2016/08/24	Modify button color from black to gray	Camille
2016/11/10	Modify LCD feature name from "MyMenu" to "Favorites"	Camille
2016/12/20	Modify chapter 1.2.2 (add internal Bluetooth)	Camille



TSC Auto ID Technology Co., Ltd.

Corporate Headquarters

9F., No.95, Minquan Rd., Xindian Dist.,
New Taipei City 23141, Taiwan (R.O.C.)

TEL: +886-2-2218-6789

FAX: +886-2-2218-5678

Web site: www.tscprinters.com

E-mail: apac_sales@tscprinters.com

tech_support@tscprinters.com

Li Ze Plant

No.35, Sec. 2, Ligong 1st Rd., Wujie Township,
Yilan County 26841, Taiwan (R.O.C.)

TEL: +886-3-990-6677

FAX: +886-3-990-5577