



MC9190-G

User Guide



MC9190-G
User Guide

72E-140936-01

Rev A

January 2011

© 2011 by Motorola Solutions, Inc. All rights reserved.

No part of this publication may be reproduced or used in any form, or by any electrical or mechanical means, without permission in writing from Motorola. This includes electronic or mechanical means, such as photocopying, recording, or information storage and retrieval systems. The material in this manual is subject to change without notice.

The software is provided strictly on an “as is” basis. All software, including firmware, furnished to the user is on a licensed basis. Motorola grants to the user a non-transferable and non-exclusive license to use each software or firmware program delivered hereunder (licensed program). Except as noted below, such license may not be assigned, sublicensed, or otherwise transferred by the user without prior written consent of Motorola. No right to copy a licensed program in whole or in part is granted, except as permitted under copyright law. The user shall not modify, merge, or incorporate any form or portion of a licensed program with other program material, create a derivative work from a licensed program, or use a licensed program in a network without written permission from Motorola. The user agrees to maintain Motorola’s copyright notice on the licensed programs delivered hereunder, and to include the same on any authorized copies it makes, in whole or in part. The user agrees not to decompile, disassemble, decode, or reverse engineer any licensed program delivered to the user or any portion thereof.

Motorola reserves the right to make changes to any software or product to improve reliability, function, or design.

Motorola does not assume any product liability arising out of, or in connection with, the application or use of any product, circuit, or application described herein.

No license is granted, either expressly or by implication, estoppel, or otherwise under any Motorola, Inc., intellectual property rights. An implied license only exists for equipment, circuits, and subsystems contained in Motorola products.

MOTOROLA, MOTO, MOTOROLA SOLUTIONS and the Stylized M Logo are trademarks or registered trademarks of Motorola Trademark Holdings, LLC and are used under license. All other trademarks are the property of their respective owners.

Motorola Solutions, Inc.
One Motorola Plaza
Holtsville, New York 11742-1300
<http://www.motorola.com>

Revision History

Changes to the original manual are listed below:

Change	Date	Description
-01 Rev. A	01/2011	Initial release.

Table of Contents

Revision History	iii
About This Guide	
Introduction	ix
Documentation Set	ix
Configurations.....	ix
Software Versions.....	x
AKU Version for Mobile 6.5 Devices.....	x
OEM Version.....	x
BTEplorer Software.....	x
Fusion Software.....	x
Chapter Descriptions	xi
Notational Conventions.....	xi
Related Documents and Software	xii
Service Information.....	xii
Chapter 1: Getting Started	
Introduction	1-1
Unpacking	1-2
Getting Started	1-2
Installing the Main Battery	1-2
Charging the Battery	1-3
Charging the Main Battery and Memory Backup Battery	1-3
Charging Spare Batteries	1-4
Removing the Main Battery	1-5
Starting the MC9190-G	1-5
Calibrating the Screen	1-6
Checking Battery Status	1-6
MC9190-G Strap	1-6
Battery Management	1-7
Battery Saving Tips	1-7
Changing the Power Settings	1-7
Changing the Display Backlight Settings	1-7

Changing the Keypad Backlight Settings	1-8
Turning Off the Radios	1-8
On Devices with Mobile 6.5	1-8
On Device with CE 6.0	1-8
WLAN Radio	1-8
Bluetooth Radio with StoneStreet One Stack Enabled	1-9

Chapter 2: Operating the MC9190-G

Introduction	2-1
Windows CE 6.0	2-1
Start Menu	2-3
Control Panel	2-4
Windows Mobile 6.5	2-5
Finger Scrolling	2-5
Home Screen	2-5
Classic Today Screen	2-7
Status Bar	2-8
Tile Bar	2-10
Start Screen	2-10
Speaker Icon	2-14
Locking the MC9190-G	2-15
Locking without PIN or Password	2-15
Locking with Simple PIN	2-15
Locking with Strong Password	2-16
Password Locking Setup	2-16
LED Indicators	2-17
Keypads	2-18
Entering Data	2-18
Using the Power Button	2-19
Wireless LAN	2-19
Windows CE Devices	2-19
Windows Mobile 6.5 Devices	2-20
Interactive Sensor Technology	2-21
Power Management	2-21
Display Orientation	2-21
Free Fall Detection	2-21
Using a Wired Headset	2-22
Using a Bluetooth Headset	2-22
Resetting the MC9190-G	2-22
Windows CE 6.0 Devices	2-22
Performing a Warm Boot	2-22
Performing a Cold Boot	2-23
Windows Mobile 6.5 Devices	2-23
Performing a Warm Boot	2-23
Performing a Cold Boot	2-23
Battery Health	2-24
Waking the MC9190-G	2-24

Chapter 3: Data Capture

Scan LED Indicators	3-1
Laser Scanning	3-1
Scanning Considerations	3-2
Imaging	3-2
Operational Modes	3-3
Imager Scanning	3-3
Image Capture	3-4
DataWedge	3-5
Enable DataWedge	3-5
Disable DataWedge	3-5
ScanSamp2 Example	3-5
ImagerSample	3-5
Using the RS507 Hands-free Imager	3-6

Chapter 4: Using Bluetooth

Introduction	4-1
Adaptive Frequency Hopping	4-1
Security	4-2
Security Mode 3 (Link Level Encryption)	4-2
Bluetooth Configuration	4-2
Bluetooth Power States	4-3
Cold Boot	4-3
Warm Boot	4-4
Suspend	4-4
Resume	4-4
Using Microsoft Bluetooth Stack with Windows Mobile 6.5	4-5
Turning the Bluetooth Radio Mode On and Off	4-5
Enabling Bluetooth	4-5
Disabling Bluetooth	4-5
Discovering Bluetooth Device(s)	4-5
Available Services	4-6
Object Push Services via Beam	4-6
Serial Port Services	4-7
ActiveSync Using Serial Port Services	4-8
Using Microsoft Bluetooth Stack with Windows CE 6.0	4-10
Power Modes	4-10
Discovering Bluetooth Device(s)	4-10
Available Services	4-11
Using Bluetooth StoneStreet One Bluetooth Stack	4-12
Turning the Bluetooth Radio Mode On and Off	4-12
Disabling Bluetooth (Windows CE 6.0)	4-12
Enabling Bluetooth (Windows CE 6.0)	4-12
Disabling Bluetooth (Windows Mobile 6.5)	4-12
Enabling Bluetooth (Windows Mobile 6.5)	4-12
Modes	4-13
Wizard Mode	4-13
Explorer Mode	4-13
Discovering Bluetooth Device(s)	4-13

Available Services	4-15
File Transfer Services	4-16
Connecting to the Internet Using an Access Point	4-17
Dial-Up Networking Services	4-18
Add a Dial-up Entry	4-19
Object Exchange Push Services	4-19
Headset Services	4-23
Serial Port Services	4-24
ActiveSync Using Serial Port Services	4-24
Personal Area Network Services	4-25
A2DP/AVRCP Services	4-25
Connect to a HID Device	4-26
Pairing with Discovered Device(s)	4-26
Bluetooth Settings	4-27
Device Info Tab	4-27
Services Tab	4-28
Security Tab	4-30
Discovery Tab	4-30
Virtual COM Port Tab	4-31
HID Tab	4-31
Profiles Tab	4-31
System Parameters Tab	4-31
Miscellaneous Tab	4-31

Chapter 5: Accessories

Introduction	5-1
Secure Device (SD) Card	5-5
Single Slot Serial/USB Cradle	5-6
Four Slot Ethernet Cradle	5-8
Four Slot Charge Only Cradle	5-9
Four Slot Spare Battery Charger	5-10
Magnetic Stripe Reader	5-10
Attaching and Removing	5-11
Setup	5-12
Battery Charging Indicators	5-13
Serial/USB Connection	5-13
Using the MSR	5-13
Cable Adapter Module	5-15
Attaching and Removing	5-15
Setup	5-16
Battery Charging Indicators	5-17
Serial/USB Connection	5-17
Universal Battery Charger (UBC) Adapter	5-18
Inserting and Removing a Battery	5-18
Battery Charging Indicators	5-18
Modem Dongle	5-20
Setup	5-21
Connecting to the MC9190-G	5-21
Connecting to the Single Slot Serial/USB Cradle	5-22

Forklift Cradle	5-23
MC9190-G Insertion and Removal	5-25
Using the Locking Mechanism	5-26
Connecting External Devices	5-26
Supported Scanners	5-27

Chapter 6: Maintenance & Troubleshooting

Introduction	6-1
Maintaining the MC9190-G	6-1
Battery Safety Guidelines	6-1
Cleaning	6-2
Approved Cleanser Active Ingredients	6-2
Harmful Ingredients	6-3
Cleaning Instructions	6-3
Special Cleaning Notes	6-3
Materials Required	6-3
Cleaning the MC9190-G	6-3
Housing	6-3
Display	6-3
Scanner Exit Window	6-3
Connector	6-3
Cleaning Cradle Connectors	6-4
Cleaning Frequency	6-4
Troubleshooting	6-5
MC9190-G	6-5
Four Slot Spare Battery Charger	6-8
Single Slot Serial/USB Cradle	6-8
Cable Adapter Module	6-9
Magnetic Stripe Reader	6-10

Appendix A: Specifications

Technical Specifications	A-1
MC9190-G	A-1

Appendix B: Voice Quality Manager

Introduction	B-1
Features	B-1
Enabling VQM	B-1
Audio Modes	B-2
Changing Audio Modes	B-2
Voice Packet Prioritization	B-3
Acoustic Echo Cancellation	B-4
Limitations	B-4
Disabling VQM	B-4

Appendix C: Keypads

Introduction	C-1
28-Key Keypad	C-2
43-Key Keypad	C-5
53-Key Keypad	C-8
3270 Emulator Keypad	C-11
5250 Emulator Keypad	C-14
VT Emulator Keypad	C-17
Keypad Special Functions	C-20
Special Characters	C-21

About This Guide

Introduction

This guide provides information about using the MC9190-G mobile computer and accessories.

✓ **NOTE** Screens and windows pictured in this guide are samples and can differ from actual screens.

Documentation Set

The documentation set for the MC9190-G is divided into guides that provide information for specific user needs.

- **MC9190-G User Guide** - describes how to use the MC9190-G mobile computer.
- **MC9190-G Integrator Guide** - describes how to set up the MC9190-G mobile computer and the accessories.
- **EMDK Help File** - provides API information for writing applications.

Configurations

This guide covers the following configurations:

Configuration	Radios	Display	Memory	Data Capture	Operating System	Keypads
MC9190-G	WLAN: 802.11a/b/g WPAN: Bluetooth	Color	256 MB RAM / 1 GB Flash	Laser, Long Range Laser, Standard Range Imager (HD, DL, SR) or Long Range Imager	Windows CE 6.0 or Mobile 6.5	28-key, 43-key, 53-key, VT, 3270, 5250 Emulators

Software Versions

This guide covers various software configurations and references are made to operating system or software versions for:

- Adaptation Kit Update (AKU) version
- OEM version
- BTE Explorer version
- Fusion version.

AKU Version for Mobile 6.5 Devices

To determine the Adaptation Kit Update (AKU) version on a Mobile 6.5 device:

Tap **Start > Settings > System > About > Version**.

The second line lists the operating system version and the build number. The last part of the build number represents the AKU number. For example, *Build 23103.5.3.3* indicates that the device is running AKU version 5.3.3.

OEM Version

To determine the OEM software version:

On Mobile 6.5, tap **Start > Settings > System > System Information > System**.

On CE 6.0, tap **Start > Settings > Control Panel > System Information > System**.

BTE Explorer Software

 **NOTE** By default, the Microsoft Bluetooth stack is enabled. BTE Explorer application is only available when the StoneStreet One Bluetooth stack is enabled. Refer to the *MC9190-G Integrator Guide* for information on selecting the Bluetooth stack.

To determine the BTE Explorer software version:

On Mobile 6.5, tap **Start > BTE Explorer > Menu > About**.

On CE 6.0, tap **BTE Explorer icon > Show BTE Explorer > File > About**.

Fusion Software

To determine the Fusion software version:

On Mobile 6.5, tap **Start > Wireless Companion > Wireless Status > Versions**.

On Windows CE 6.0, tap **Wireless Strength icon > Wireless Status > Versions** or tap **Start > Programs > Fusion > Wireless Status > Versions**.

Chapter Descriptions

Topics covered in this guide are as follows:

- *Chapter 1, Getting Started*, provides information on getting the mobile computer up and running for the first time.
- *Chapter 2, Operating the MC9190-G*, explains how to use the mobile computer. This includes instructions for powering on and resetting the mobile computer, entering and capturing data.
- *Chapter 4, Using Bluetooth*, explains how to perform Bluetooth functionality on the mobile computer.
- *Chapter 5, Accessories*, describes the accessories available for the mobile computer and how to use the accessories with the mobile computer.
- *Chapter 6, Maintenance & Troubleshooting*, includes instructions on cleaning and storing the mobile computer, and provides troubleshooting solutions for potential problems during mobile computer operation.
- *Appendix A, Specifications*, includes a table listing the technical specifications for the mobile computer.
- *Appendix B, Voice Quality Manager*, provides information on Voice Quality Manager software.
- *Appendix C, Keypads*, contains the keypad functions/special characters for the keypads. includes a table listing the technical specifications for the mobile computer.

Notational Conventions

The following conventions are used in this document:

- “Mobile computer” refers to the Motorola MC9190-G hand-held computer.
- *Italics* are used to highlight the following:
 - Chapters and sections in this guide
 - Related documents
- **Bold** text is used to highlight the following:
 - Dialog box, window and screen names
 - Drop-down list and list box names
 - Check box and radio button names
 - Icons on a screen
 - Key names on a keypad
 - Button names on a screen.
- Bullets (•) indicate:
 - Action items
 - Lists of alternatives
 - Lists of required steps that are not necessarily sequential.
- Sequential lists (e.g., those that describe step-by-step procedures) appear as numbered lists.

Related Documents and Software

The following documents provide more information about the MC9190 mobile computers.

- *MC9190-G Quick Start Guide*, p/n 72-139206-xx
- *MC9190-G Regulatory Guide*, p/n 72-139207-xx
- *MC9190-G Integrator Guide*, p/n 72E-140937-xx
- *Enterprise Mobility Developer Kits (EMDKs)*, available at: <http://supportcentral.motorola.com>.
- Device Configuration Package (DCP for MC9190c60) and Platform SDK (PSDK9190c60) for MC9190-G with Windows CE 6.0, available at: <http://supportcentral.motorola.com>.
- ActiveSync software, available at: <http://www.microsoft.com>.

For the latest version of this guide and all guides, go to: <http://supportcentral.motorola.com>.

Service Information

If you have a problem with your equipment, contact Motorola Enterprise Mobility support for your region. Contact information is available at: <http://www.motorola.com/enterprisemobility/contactsupport>.

When contacting Enterprise Mobility support, please have the following information available:

- Serial number of the unit
- Model number or product name
- Software type and version number.

Motorola responds to calls by email, telephone or fax within the time limits set forth in support agreements.

If your problem cannot be solved by Motorola Enterprise Mobility Support, you may need to return your equipment for servicing and will be given specific directions. Motorola is not responsible for any damages incurred during shipment if the approved shipping container is not used. Shipping the units improperly can possibly void the warranty.

If you purchased your Enterprise Mobility business product from a Motorola business partner, contact that business partner for support.

Chapter 1 Getting Started

Introduction

This chapter explains how to install and charge the batteries, replace the strap and start the MC9190-G for the first time.

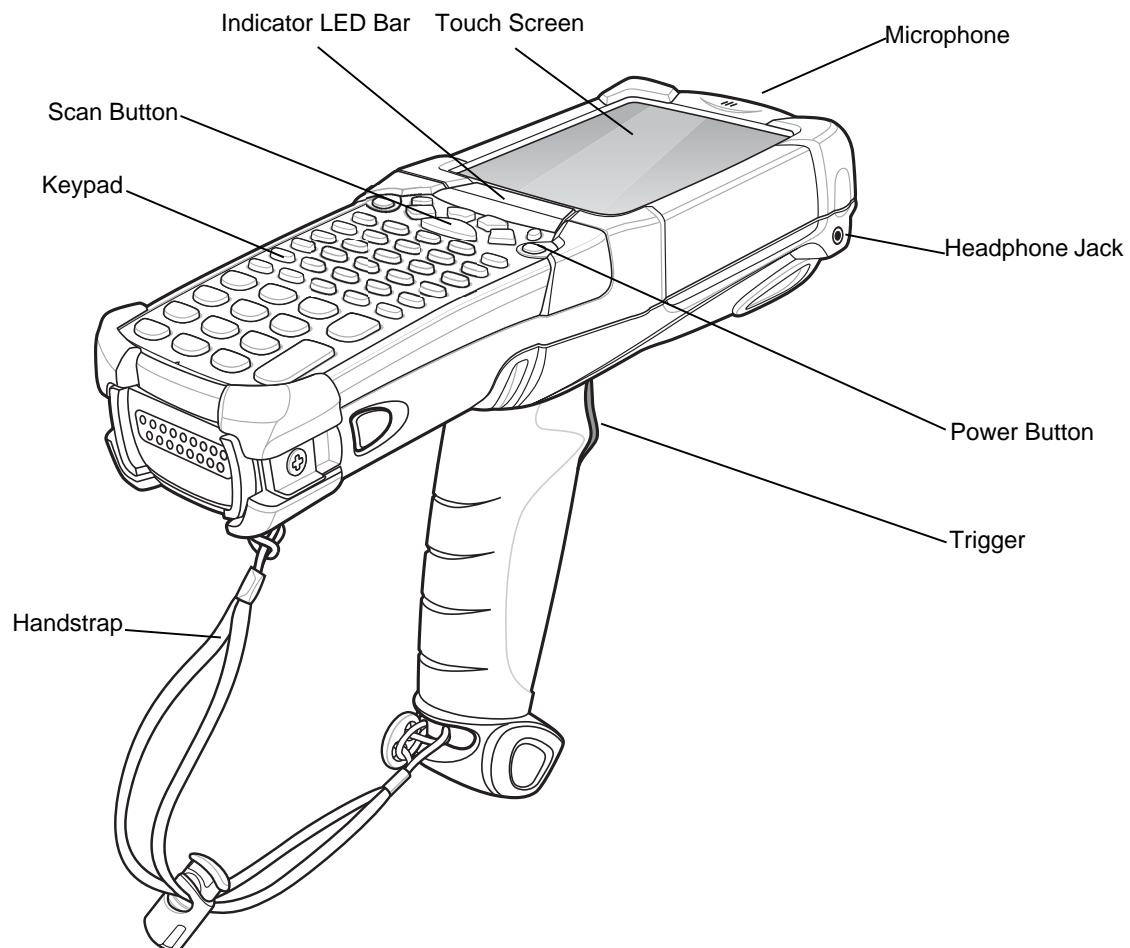

Figure 1-1 MC9190-G

Unpacking

Carefully remove all protective material from around the MC9190-G and save the shipping container for later storage and shipping.

Verify that you received all equipment listed below:

- mobile computer
- lithium-ion battery
- strap, attached to the MC9190-G
- stylus, in the stylus silo
- Regulatory Guide
- Quick Start Guide.

Inspect the equipment for damage. If you are missing any equipment or if you find any damaged equipment, contact the Motorola Global Interactive Center immediately. See [page xii](#) for contact information.

Getting Started

In order to start using the MC9190-G for the first time:

- install the main battery
- charge the main battery and backup battery
- start the MC9190-G
- configure the MC9190-G.

The main battery can be charged before or after it is installed. Use one of the spare battery chargers to charge the main battery (out of the MC9190-G), or one of the cradles to charge the main battery installed in the MC9190-G.

Installing the Main Battery

Before using the MC9190-G, install a lithium-ion battery by sliding the battery into the MC9190-G as shown in [Figure 1-2](#).

- ✓ **NOTE** Ensure the battery is fully inserted. Two audible clicks can be heard as the battery is fully inserted. A partially inserted battery may result in unintentional data loss.

When a battery is fully inserted in a MC9190-G for the first time, upon first power up, the device boots and powers on automatically.

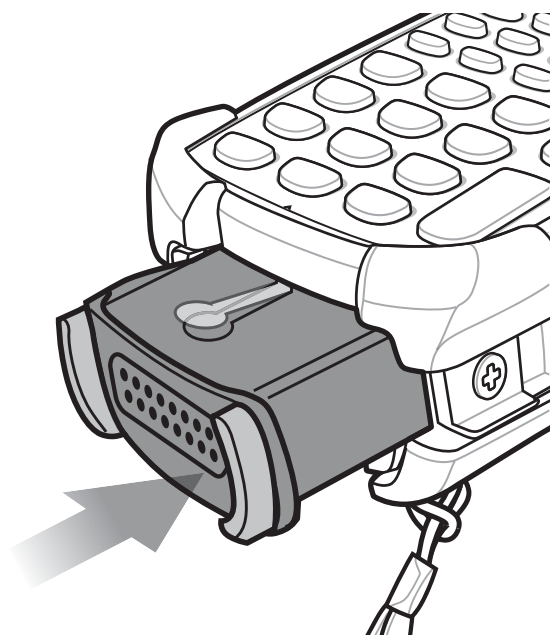

Figure 1-2 Installing the Main Battery

Charging the Battery



CAUTION Ensure that you follow the guidelines for battery safety described in [Battery Safety Guidelines on page 6-1](#).

Charging the Main Battery and Memory Backup Battery

Before using the MC9190-G for the first time, charge the main battery until the amber charge indicator light remains lit (see [Table 1-1 on page 1-4](#) for charge status indications). The main battery fully charges in less than four hours. The MC9190-G can be charged using a cradle, the CAM, or the MSR with the appropriate power supply.

The MC9190-G is also equipped with a memory backup battery which automatically charges from the main battery whether or not the MC9190-G is operating or is in suspend mode. The memory backup battery retains data in memory for at least 30 minutes when the MC9190-G's main battery is removed or fully discharged. When the MC9190-G is used for the first time or after the memory backup battery has fully discharged, the memory backup battery requires approximately 15 hours to fully charge. Do not remove the main battery from the MC9190-G for 15 hours to ensure that the memory backup battery fully charges. If the main battery is removed from the MC9190-G or the main battery is fully discharged, the memory backup battery completely discharges in several hours.

When the main battery reaches a very low battery state, the combination of main battery and backup battery retains data in memory for at least 72 hours.



NOTE Do not remove the main battery within the first 15 hours of use. If the main battery is removed before the backup battery is fully charged, data may be lost.

Use the following to charge batteries:

- **Cradles:** The MC9190-G slips into the cradles for charging the battery in the MC9190-G (and spare batteries, where applicable). For detailed cradle setup and charging procedures refer to the *MC9190 Integrator Guide*.
 - Single Slot Serial/USB Cradle.
 - Four Slot Ethernet Cradle
 - Four Slot Charge Only Cradle.
- **Accessories:** The MC9190-G snap-on accessories provide charging capability, when used with one of the accessory charging cables. For detailed snap-on setup and charging procedures refer to the *MC9190 Integrator Guide*.
 - CAM
 - MSR.
- **Chargers:** The MC9190-G spare battery charging accessories are used to charge batteries that are removed from the MC9190-G. For detailed spare battery charging accessories setup and charging procedures refer to the *MC9190 Integrator Guide*.
 - Single Slot Serial/USB Cradle
 - Four Slot Spare Battery Charger
 - Universal Battery Charger (UBC) Adapter.

✓ **NOTE** To achieve the best battery life in MC9190-Gs with multiple radios, turn off the radios that are not being used. See [Turning Off the Radios on page 1-8](#) for more information.

To charge the main battery:

1. Ensure the accessory used to charge the main battery is connected to the appropriate power source.
2. Insert the MC9190-G into a cradle or attach the appropriate snap-on module.
3. The MC9190-G starts to charge automatically. The amber charge LED, in the Indicator LED Bar, lights to indicate the charge status. See [Table 1-1](#) for charging indications.

The main battery usually fully charges in less than four hours.

Table 1-1 MC9190-G LED Charge Indicators

LED	Indication
Off	MC9190-G not in cradle or connected to a CAM or MSR. MC9190-G not placed correctly. Charger is not powered.
Fast Blinking Amber	Error in charging; check placement of the MC9190-G.
Slow Blinking Amber	MC9190-G is charging.
Solid Amber	Charging complete. Note: When the battery is initially inserted in the MC9190-G, the amber LED flashes once if the battery power is low or the battery is not fully inserted.

Charging Spare Batteries

Use the following three accessories to charge spare batteries:

- Single Slot Serial/USB Cradle

- Four Slot Spare Battery Charger
- UBC Adapter.

Refer to [Chapter 5, Accessories](#) for information on charging a spare battery using an accessory.

Removing the Main Battery

To remove the main battery:

1. Prior to removing the battery, press the red **Power** button.
On Windows Mobile 6.5 devices, the **PowerKey Action** window appears. Tap **Safe Battery Swap**.
2. The Indicator LED Bar lights red.
3. When the Indicator LED turns off, press the primary battery releases. The battery partially ejects from the MC9190-G.
4. Pause three to four seconds while the MC9190-G performs battery removal shutdown.
5. Press the secondary battery release, on top of the battery, and slide the battery out of the MC9190-G.

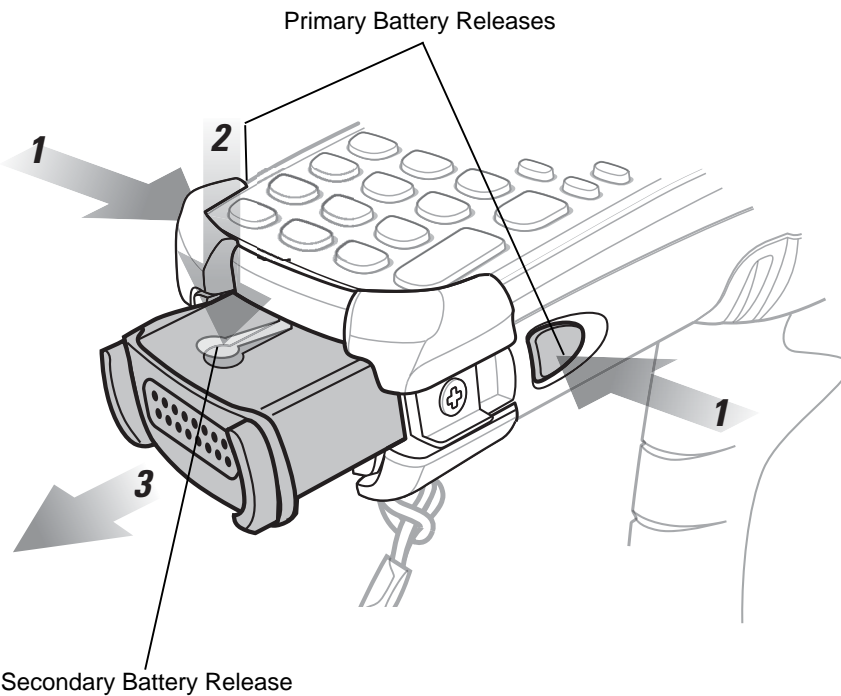

Figure 1-3 Removing the Main Battery

Starting the MC9190-G

Press the red **Power** button to turn on the MC9190-G. If the MC9190-G does not power on, perform a cold boot. See [Resetting the MC9190-G on page 2-22](#).

- ✓ **NOTE** When a battery is fully inserted in a MC9190-G for the first time, upon the MC9190-G's first power up, the device boots and powers on automatically.

When the MC9190-G is powered on for the first time, it initializes its system. The splash screen appears for a short period of time.

Calibrating the Screen

To calibrate the screen so the cursor on the touch screen aligns with the tip of the stylus:

1. Using the stylus carefully press and briefly hold the tip of stylus on the center of each target that appears on the screen.

✓ **NOTE** To re-calibrate the screen at anytime, press **FUNC + ESC** on the MC9190-G to launch the calibration screen application.

2. Repeat as the target moves around the screen or press **ESC** to cancel.

Checking Battery Status

To check the charge level of the main battery or backup battery:

- On Windows CE 6.0 devices: tap **Start > Settings > Control Panel > Power** to display the **Battery Status** window.
- On Windows Mobile 6.5 devices: tap **Start > Settings > System > Power** to display the **Power** window.

To save battery power, set the MC9190-G to turn off after a specified number of minutes.

MC9190-G Strap

The strap may be moved to either the left or right side of the MC9190-G to suit user preferences.

To reposition the strap:

1. Slip the button through the end loop and remove from the handle.
2. Open strap loop and slide the handstrap through the loop.
3. Slide the loop out of the connector post.
4. Reverse the procedure to re-attach the strap. Two strap connectors are provided on the MC9190-G's main body. The handstrap may be attached to either connector.

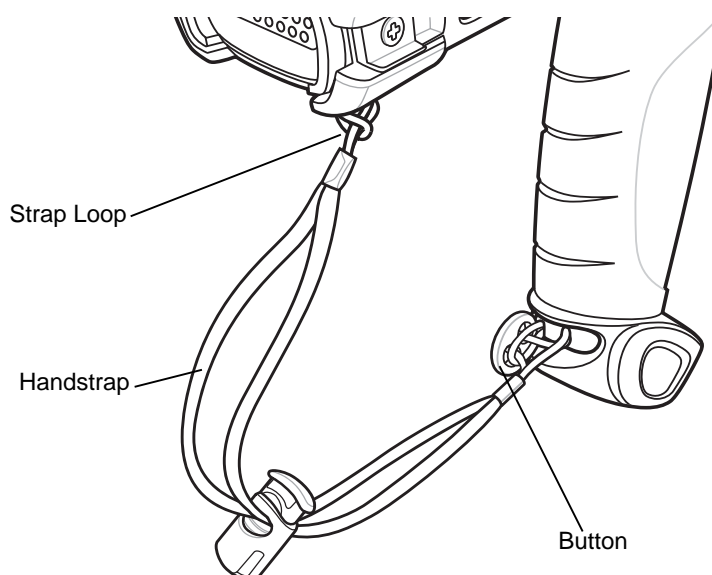

Figure 1-4 *Reposition the Strap*

Battery Management

Battery Saving Tips

- Leave the MC9190-G connected to AC power at all times when not in use.
- Set the MC9190-G to turn off after a short period of non-use.
- Set the display to turn off or dim backlight.
- Set the keyboard backlight to turn off after a short period of non-use.
- Turn off all wireless radio activity when not in use.
- Power off the MC9190-G when charging to charge at a faster rate.

Changing the Power Settings

To set the MC9190-G to turn off after a short period of non-use:

1. On devices with Windows CE 6.0, tap **Start > Settings > Control Panel > Power > Advanced**.
or
On devices with Windows Mobile 6.5, tap **Start > Settings > System > Power > Advanced**.
2. Select the **On battery power: Turn off device if not used for:** check box and select a value from the drop-down list box.
3. Tap **OK**.

Changing the Display Backlight Settings

To change the display backlight settings in order to conserve more battery power:

1. On devices with Windows CE 6.0, tap **Start > Settings > Control Panel > Backlight > Battery Power**.
or
On devices with Windows Mobile 6.5, tap **Start > Settings > System > Backlight > Battery Power**.
2. Select the **On battery power: Disable backlight if not used for:** check box and select a value from the drop-down list box.
3. Tap the **Brightness** tab.
4. Tap the **Disable backlight** check box to completely turn off the display backlight.
5. Use the slider to set the brightness of the backlight. Set it to a low value to save battery power.
6. Tap **OK**.

Changing the Keypad Backlight Settings

To change the keypad backlight settings in order to conserve more battery power:

1. On devices with Windows CE 6.0, tap **Start > Settings > Control Panel > Keypress > Battery Power**.
or
On devices with Windows Mobile 6.5, tap **Start > Settings > System > Keypress > Battery Power**.
2. Select the **On Battery Power: Disable keylight if not used for:** check box and select a value from the drop-down list box.
3. Tap **Advanced**.
4. Tap the **Disable keylight** check box to completely turn off the display backlight.
5. Tap **OK**.

Turning Off the Radios

On Devices with Mobile 6.5

Windows Mobile 6.5 devices include **Wireless Manager**, which provides a simple method of enabling, disabling, and configuring all the device's wireless capabilities in one place.

1. To open **Wireless Manager**, tap the Status Bar and then the **Connectivity** icon and select **Wireless Manager**.
or tap **Start > Settings > Connections > Wireless**.
2. To enable or disable a wireless connection, tap its blue bar.
3. To enable or disable all wireless connections, tap and hold the **All** bar.
4. To configure settings for a connection, tap **Menu**.

On Device with CE 6.0

WLAN Radio

To turn off the WLAN radio tap the **Fusion Signal Strength** icon on the task tray and select **Disable Radio**. A red X appears across the icon indicating that the radio is disabled (off).

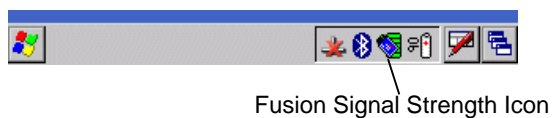

Figure 1-5 *Fusion Signal Strength Icon*

To turn the radio back on, tap the **Fusion Signal Strength** icon on the task tray and select **Enable Radio**. The red X disappears from the icon indicating that the radio is enabled (on).

Bluetooth Radio with StoneStreet One Stack Enabled

To turn off the Bluetooth radio, tap the **Bluetooth** icon in the task tray and select **Disable Bluetooth**.



Figure 1-6 *Bluetooth Icon*

To turn on the Bluetooth radio, tap the **Bluetooth** icon in the task tray and select **Enable Bluetooth**.

Chapter 2 Operating the MC9190-G

Introduction

This chapter explains the physical buttons, status icons and controls on the MC9190-G, how to use the MC9190-G, including instructions for powering on and resetting, using the stylus and a headset, entering information and data capture.

Windows CE 6.0

The **Taskbar** at the bottom of the window displays the active programs, current time, battery status and communication status.

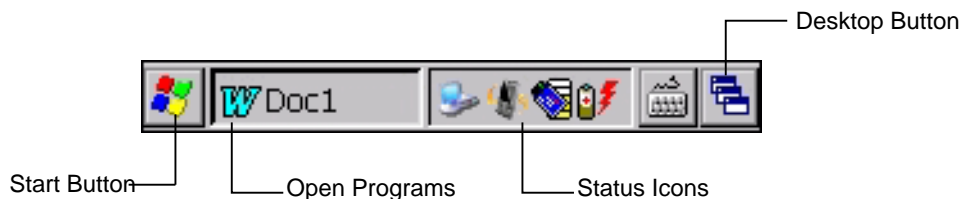
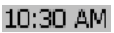

















Figure 2-1 *Taskbar*

Status icons are shown in the taskbar to indicate present status of the MC9190-G. Double tapping some status icons displays the corresponding setup window and enables you to change or adjust its settings from the window. Single tapping other status icons displays corresponding menus.

Table 2-1 Status Icons

Status Icon	Description
	Clock: Indicates the current time.
	Battery: This icon indicates that the main battery is charging or that the terminal is operating on AC power. Double tapping on this icon opens the Power Properties window.
	AC Plug: Indicates that the battery is fully charged and the MC9190-G is running on external power.
	Battery: This icon indicates that the battery is fully charged (100% charged). The battery status icons provide the battery status in 10% increments from 10% to 100%.
	Serial Connection: It is displayed when the terminal is connected to a host computer with a serial cable.
	Wireless Connection Status: Indicates WLAN signal strength.
	IST: Open the IST control panel.
	Bluetooth Enabled: Indicates that the Bluetooth radio is on (BTEplorer only).
	Bluetooth Disabled: Indicates that the Bluetooth radio is off (BTEplorer only).
	Bluetooth Communication: Indicates that the MC9190-G is communicating with another Bluetooth device (BTEplorer only).
	DataWedge Running: Indicates that the DataWedge application is running.
	DataWedge Idle: Indicates that the DataWedge application is idle.
	Shift: Indicates that the SHIFT button function is selected.
	FUNC: Indicates that the FUNC button function is selected.
	CTRL: Indicates that the CTRL button function is selected.
	ALT: Indicates that the ALT character selection is selected.
	ALPHA: Indicates that the MC9190-G is in ALPHA button mode is selected.

Start Menu

















To open the Start menu, tap  at the bottom left corner of the screen. [Table 2-7](#) lists the default applications available in the **Programs** menu.

Table 2-2 Applications in the Programs Menu

Icon	Description	Icon	Description
	Communications Folder: Opens the Communication folder.		Fusion Folder: Open the Wireless Companion folder.
	AirBEAM Client: Allows specially designed software packages to be transferred between a host server and the MC9190-G. Refer to the <i>MC9190-G Integrator Guide</i> for more information.		BT Information: Display information about the Bluetooth radio and generate a Bluetooth address bar code.
	BTScanner CtlPanel: Set com port to use with a Bluetooth scanner.		Command Prompt: Opens a DOS command prompt window.
	CtlPanel: View and change MC9190-G settings such as: Scanner Parameters, Display Settings, Audio Settings, Printer Settings, Date and Time Settings, Touch Screen Settings, etc.		Internet Explorer: Browse Web and WAP sites as well as download new programs and files from the Internet.
	Media Player: Listen to music.		Microsoft WordPad: Create documents.
	MSP Agent: Interacts with MSP agents to collect monitoring and asset information to enable the configuration, provisioning, monitoring and troubleshooting of the MC9190-G. Refer to the <i>MC9190-G Integrator Guide</i> for more information.		Rapid Deployment Client: Facilitates software downloads from a Mobility Services Platform Console FTP server to the MC9190-G. Refer to the <i>MC9190-G Integrator Guide</i> for more information.
	Remote Desktop Connection: Log onto Windows NT server type computers and use all of the programs that are available on that computer from the MC9190-G.		TelnetCE: Opens the Wavelink Telnet client.
	WarmBoot: Warm boots the MC9190-G.		Windows Explorer: Organize and manage files on your device.

Control Panel

Table 2-3 lists the applications in the **Control Panel**.

Table 2-3 Programs on the Control Panel





























Icon	Description	Icon	Description
	Backlight: Adjust the backlight brightness and power settings.		Bluetooth Device Properties: Launch the Bluetooth application.
	Certificates: See information about certificates installed on the MC9190-G.		DataWedge: Sample scanning application. Icon appears after installation.
	Date/Time: Change date, time and time zone information.		Device Management: Enables downloading and installation of new software packages.
	Dialing: Set dialing properties for modem communication and change telephony settings.		Display: Change desktop background, appearance, backlight and brightness.
	Error Reporting: Choose whether to MC9190-G collects software operation information to use if a serious error occurs.		Input Panel: Switch input methods and set input options.
	Internet Options: Control how the MC9190-G connects to the internet.		IST Settings: Set the appropriate settings for configuring the MC9190-G's Interactive Sensor Technology.
	Keyboard: Change keyboard repeat delay and rate.		Keypad Light: Adjust keypad light settings.
	Mouse: Adjust double-click sensitivity for both the speed and timing.		Network and Dial-up Connections: Connect to other computers, networks and the Internet using a modem.
	Owner: Change owner's personal profiles.		Password: Set a password for the MC9190-G.
	PC Connection: Change settings for connectivity of a host computer.		Power: View and control MC9190-G power settings.
	Regional Settings: Change how numbers, currencies, dates and times appear.		Remove programs: Remove programs installed on the MC9190-G.

Table 2-3 *Programs on the Control Panel*

Icon	Description	Icon	Description
	Screen Resolution: Sets the screen resolution to either QVGA or VGA. See MC9190-G Integrator Guide for more information.		Stylus: Calibrate the touch screen and adjust double-tap timing.
	System: View system information and change memory settings.		System Info: View information on the MC9190-G's system components.
	USBConfig: Configure the MC9190-G USB port.		Volume & Sounds: Select the type of actions for which to hear sounds and customize notifications for different events.

Windows Mobile 6.5

The following section describes the operation of the Windows Mobile 6.5 operating system.

Finger Scrolling

Windows Mobile 6.5 adds finger scrolling capabilities to the display. Finger scrolling can be used to scroll up and down web pages, documents, and lists such as the contacts list, file list, message list, calendar appointments list, and more.

When finger scrolling, swipe or flick your finger on the screen. To scroll down, swipe your finger upward on the screen. To scroll up, swipe your finger downward on the screen. To auto-scroll, flick your finger upward or downward on the screen. Touch the screen to stop scrolling.

Home Screen

The default home screen on the MC9190-G is the Windows Mobile Home screen. The Home screen contains a Status Bar at the top of the screen and a Tile Bar at the bottom of the screen.

The Home screen is scrollable and contains a list of application plug-ins and an Information Status bar. The Information Status bar highlights the application plug-in that is under it and provides additional information.

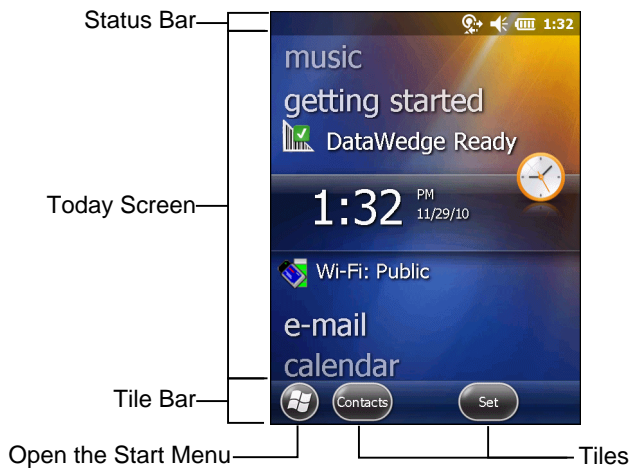

Figure 2-2 *Windows Mobile Home Screen*

Touch and hold the screen with your finger and move the Home screen up and down. As the application names move under the Information Status bar, information relevant to that application appear in the bar.



Figure 2-3 *Moving Today Screen*

Touch and hold the Information Status bar and move it up and down over an application name. Remove your finger and the Information Status bar and application name center in the screen.

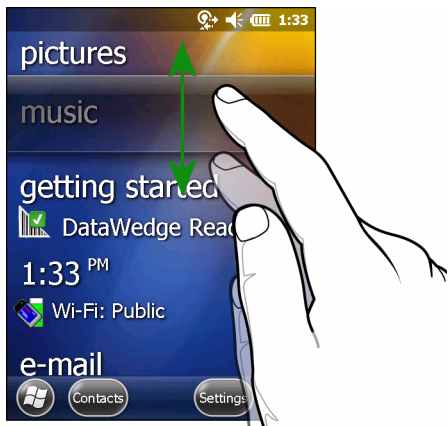

Figure 2-4 Moving Information Status Bar



Figure 2-5 Information Bar Example

To customize the **Home** screen, tap > **Settings** > **Today**. On the horizontal scroll, use **Appearance** to customize the background and the **Items** to change the display format.

Classic Today Screen

The user can change to the classic Today screen layout that is used in Windows Mobile 6.1.

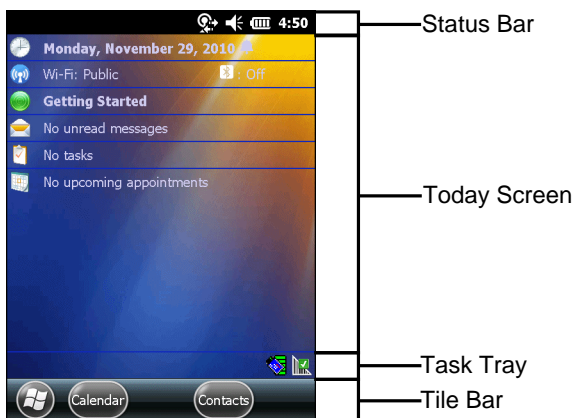

Figure 2-6 Classic Today Screen

To change to the classic view tap  > Settings > Home > Items.

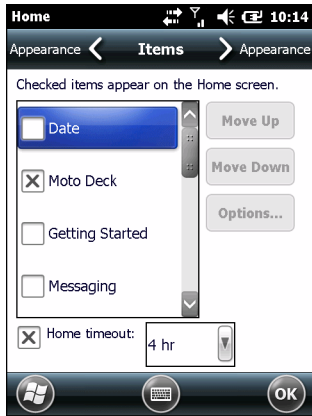









Figure 2-7 Home Screen Settings

Deselect the **Windows Default** checkbox and select any of the other checkboxes and then tap .

The task bar at the bottom of the screen can contain the task tray icons listed in [Table 2-4](#).

Table 2-4 Task Tray Icons

Icon	Description
	Wireless connection status: Indicates WLAN signal strength and opens the Wireless Applications menu.
	Bluetooth Enabled: Indicates that the Bluetooth radio is on (Displays only if the StoneStreet One Bluetooth stack is enabled).
	Bluetooth Disabled: Indicates that the Bluetooth radio is off (Displays only if the StoneStreet One Bluetooth stack is enabled).
	Bluetooth Communication: Indicates that the MC9190-G is communicating with another Bluetooth device (Displays only if the StoneStreet One Bluetooth stack is enabled).
	ActiveSync: Indicates an active serial connection between the MC9190-G and the development computer.
	DataWedge Running: Indicates that the DataWedge application is running.
	DataWedge Idle: Indicates that the DataWedge application is idle.

Status Bar

The Status Bar at the top of the screen displays the status icons listed in [Table 2-5](#).

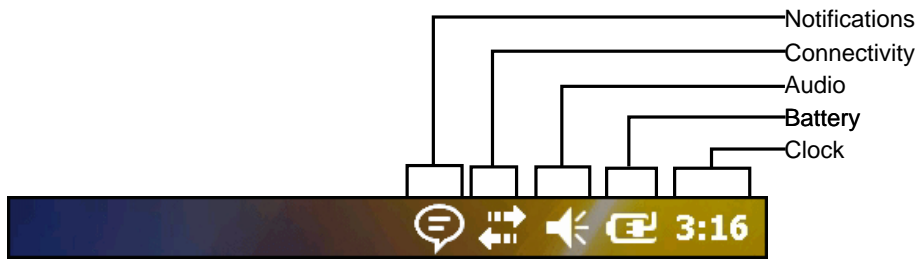

Figure 2-8 Status Bar Icons

Table 2-5 Status Bar Icons

Icon	Description	Icon	Description
Notifications			
	Indicates a reminder of an upcoming calendar event.		Notification that one or more instant messages were received.
	Notification that one or more e-mail/text messages were received.		There are more notification icons than can be displayed.
Connectivity			
	Connection is active.		Connection is not active.
	Synchronization is occurring.		WLAN available.
	WLAN in use.		
Audio			
	All sounds are on.		All sounds are off.
Battery			
	Battery is charging.		Battery has a full charge.
	Battery has a high charge.		Battery has a medium charge.
	Battery has a low charge.		Battery has a very low charge.

Tap the Status Bar to display an Icon bar. Tap an icon to get additional notification or status information.



Figure 2-9 Icon Bar

Table 2-6 Icon Bar Icons

Icon	Description
	Magnify: Enlarges the screen.
	Connectivity: Displays the Connectivity dialog box.
	Volume: Displays the Volume dialog box.
	Power: Displays the Power window.
	Clock & Alarms: Opens the Clocks & Alarms window.

Tile Bar

The Tile Bar, located at the bottom of the screen, contains the Start tile to open the Start Menu. It also displays tiles that vary depending upon the open application.



Figure 2-10 Tile Bar Examples

Start Screen

To open the Start screen, tap at the bottom left corner of the screen.

Swipe upward to view more program and folder icons.

Move often-used program and folder icons anywhere on the Start screen for easy access. Press and hold the icon to move. Drag the icon to a new location and release.

Table 2-7 lists the default icons available on the Start screen.

Table 2-7 Programs on the Start Screen



























Icon	Description	Icon	Description
	Home: Displays the Home screen.		Text: Send an SMS text message.
	Contacts: Keep track of friends and colleagues.		E-mail: Send an Email.
	Internet Explorer: Browse Web and WAP sites as well as download new programs and files from the Internet.		Battery Swap: Properly shuts down the MC9190-G during battery replacement.
	Calendar: Keep track of appointments and create meeting requests.		Settings: Open the Settings folder. <i>Table 2-8</i> lists the default icons available on the Settings folder.
	Pictures & Videos: View and manage pictures, animated GIFs, and video files.		Getting Started: Launch the Getting Started application.
	Windows Media: Play back audio and video files.		Alarms: Set the device clock to the date and time of your locale. Alarms can also be set at specified days and times of a week.
	Marketplace: Purchase applications from the Marketplace.		Messenger: Use this mobile version of Windows Live Messenger.
	Windows Live: Use this mobile version of Windows Live™ to find information on the web.		Microsoft My Phone: Synchronizes the MC9190-G's contacts, calendar, tasks, text messages, music, photos videos and documents with a Microsoft My Phone account.
	MSN Money: Keep track of your finances.		MSN Weather: Check the local weather.
	Calculator: Perform basic arithmetic and calculations, such as addition, subtraction, multiplication, and division.		Games: Play games.
	Office Mobile: Use the complete suite of Microsoft® Office applications for your mobile device.		Notes: Create handwritten or typed notes, drawings, and voice recordings.
	File Explorer: Organize and manage files on your device.		Tasks: Keep track of your tasks.
	ActiveSync: Synchronize information between the MC9190-G and a host computer or the Exchange Server.		Internet Sharing: Connect a notebook computer to the Internet using the MC9190-G's data connection.

Table 2-7 Programs on the Start Screen (Continued)













Icon	Description	Icon	Description
	Help: Access on-line Help topics.		Task Manager: Enables viewing of memory and CPU allocations and stops running processes. Refer to the <i>Microsoft Applications for Windows Mobile 6 User Guide</i> for more information.
	Adobe Reader: View pdf files.		Search Phone: Search contacts, data, and other information on the MC9190-G. Refer to the <i>Microsoft Applications for Windows Mobile 6 User Guide</i> for more information.
	Wireless Companion Folder: Open the Wireless Companion folder.		BT Information: Display information about the Bluetooth radio and generate a Bluetooth address bar code.
	AirBEAM Client: Allows specially designed software packages to be transferred between a host server and the MC9190-G. Refer to the <i>MC9190-G Integrator Guide</i> for more information.		BTScanner CtlPanel: Set com port to use with a Bluetooth scanner.
	Modem Link: Enables the MC9190-G to be used as a modem.		Remote Desktop Mobile: Log onto Windows NT server type computers and use all of the programs that are available on that computer from the MC9190-G.
	MSP Agent: Interacts with MSP agents to collect monitoring and asset information to enable the configuration, provisioning, monitoring and troubleshooting of the MC9190-G. Refer to the <i>MC9190-G Integrator Guide</i> for more information.		BTExplorer: Manages StoneStreet One Bluetooth connections. Refer to the <i>MC9190-G Series MC9190-G Integrator Guide</i> for more information. Appears only if the StoneStreet One Bluetooth stack is enabled.
	Rapid Deployment Client: Facilitates software downloads from a Mobility Services Platform Console FTP server to the MC9190-G. Refer to the <i>MC9190-G Integrator Guide</i> for more information.		

Table 2-8 *Setting Applications*





































Icon	Description	Icon	Description
	Clock & Alarms: Set the device clock to the date and time of your locale. Alarms can also be set at specified days and times of a week.		Lock: Set a password for the MC9190-G.
	Home: Customize the appearance of the Home screen and the information to display on it.		Sounds & Notifications: Enable sounds for events, notifications, and more, and set the type of notification for different events.
	Personal Folder: Contains personal setting applications.		Connections Folder: Contains connection setting applications.
	System Folder: Contains system setting applications.		Microsoft My Phone: Synchronizes the phone's contacts, calendar, tasks, text messages, music, photos, videos and other documents with your My Phone account at www.microsoft.com .
Connections Folder			
	Beam: Set the MC9190-G to receive incoming IrDA beams.		Connections: Set up one or more types of modem connections for your device, such as phone dial-up, GPRS, Bluetooth, and more, so that your device can connect to the Internet or a private local network.
	Bluetooth: Open the Microsoft or StoneStreet One Bluetooth application, set the MC9190-G to visible mode and scan for other Bluetooth devices in the area.		Domain Enroll: Make your device an AD domain member for device management and security. Refer to the <i>Microsoft Applications for Windows Mobile 6 User Guide</i> for more information.
	Wi-Fi: Setup wireless network connection and customize settings.		USB to PC: Enables or disables the enhanced network connectivity.
	Wireless Manager: Enables or disables the MC9190-G's wireless radios and customizes Wi-Fi and Bluetooth settings.		
Personal Folder			
	Buttons: Assign a program to a button.		Owner Information: Enter personal information on the MC9190-G.
System Folder			
	About: View basic information such as the Windows Mobile® version and type of processor used on the MC9190-G.		Certificates: See information about certificates installed on the MC9190-G.

Table 2-8 *Setting Applications (Continued)*

Icon	Description	Icon	Description
	Backlight: Set display backlight brightness and time-out settings.		Customer Feedback: Submit feedback on the Windows Mobile 6 software.
	Error Reporting: Enable or disable the Microsoft's error reporting function.		Encryption: Allow files on a storage card to be encrypted. Encrypted files are readable only on your device.
	Managed Programs: Displays the programs that were installed on the MC9190-G using Mobile Device Manager.		IST Settings: Set the appropriate setting for configuring the device's Interactive Sensor Technology.
	Memory: Check the device memory allocation status and memory card information and stop currently running programs.		Keylight: Set keypad backlight time-out settings.
	Power: Check battery power and set the time-out for turning off the display to conserve battery power.		Regional Settings: Set the regional configuration to use, including the format for displaying numbers, currency, date, and time on the MC9190-G.
	Screen: Change the screen orientation, re-calibrate the screen, and change the screen text size.		Remove Programs: Remove programs that you installed on the MC9190-G.
	System Info: Displays the MC9190-G's software and hardware information.		USBConfig: Configure the MC9190-G USB port.
	Task Manager: Stop running programs and processes.		UI Settings: Sets Start menu grid view.
	DataWedge: Sample scanning application.		

Speaker Icon

Adjust the system volume using the **Speaker** icon.

1. Tap the Status Bar and then tap the **Speaker** icon. The **Volume** dialog box appears.
2. Tap and move the slide bar to adjust the volume.
3. Select the **On** or **Off** radio button to turn the speaker on or off.

✓ **NOTE** Use can also adjust the system volume using the Sounds & Notifications window or by using the keypad.

Locking the MC9190-G

Lock the MC9190-G by disabling key presses and screen tap or by requiring a password.

Locking the MC9190-G turns off keyboard and touch screen functionality. This is helpful when the MC9190-G is turned on and you want to prevent accidental key presses.

To lock the device, tap  > .

Locking without PIN or Password

When the MC9190-G is locked, the **Lock** screen appears.

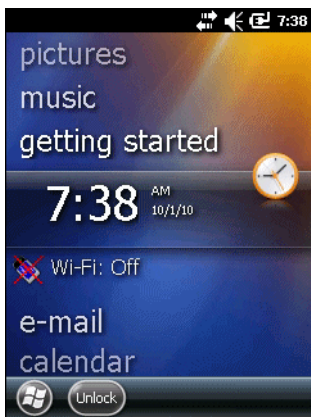

Figure 2-11 Lock Screen

On an MC9190-G, tap **Unlock** and then tap **Unlock** again.

Locking with Simple PIN

When the MC9190-G is locked, the **Lock** screen appears.

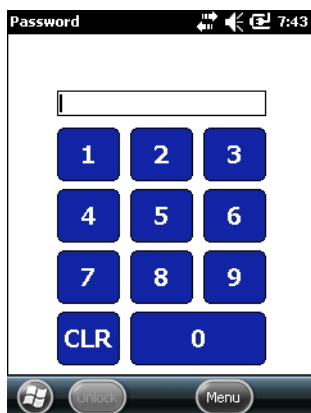

Figure 2-12 Simple PIN Lock Screen

Enter the PIN and then tap **Unlock**.

Locking with Strong Password

When the MC9190-G is locked, the **Lock** screen appears.

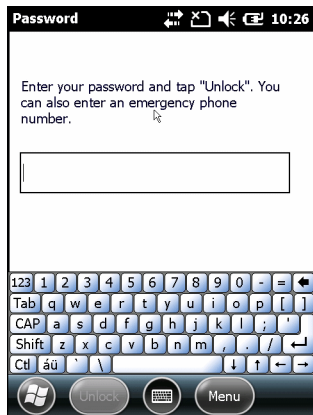

Figure 2-13 Strong Password Lock Screen

Enter the strong password and then tap **Unlock**.

Password Locking Setup

Use the **Password** window to set a password to disable unauthorized access to the MC9190-G.

- ✓ **NOTE** If the MC9190-G is configured to connect to a network, use a strong (difficult to figure out) password to help protect network security. Password cracking tools continue to improve and the computers used to crack passwords are more powerful than ever.

1. Tap  > **Settings** > **Lock** > **Password**.

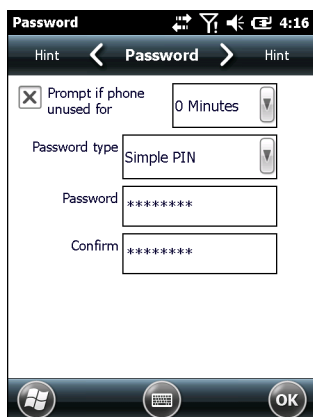





Figure 2-14 Password Window

2. Select **Prompt if device unused for** check box to enable password protection.
3. From the drop-down list, select a time value for the protection to take affect after non-use.
4. From the **Password type**: drop-down list, select either **Simple PIN** or **Strong alphanumeric**.
5. For a simple password, enter a four-digit password in the **Password** field.
For a stronger password:

- a. Enter a seven character password in the **Password:** field. A strong password must contain at least seven characters and contain at least three of the following: uppercase and lowercase letters, numerals, and punctuation.
 - b. Re-enter the password in the **Confirm:** field.
6. Tap .
 7. In the horizontal scroll, select **Hint**. Enter a hint to remember the password if you forget it.
 8. Tap .
 9. In the text box, enter a hint for a password reminder.
 10. Tap .

LED Indicators

The MC9190-G has an LED Indicator Bar that contains LEDs that indicate scanning and charging status. [Table 2-9](#) describes the LED indications.

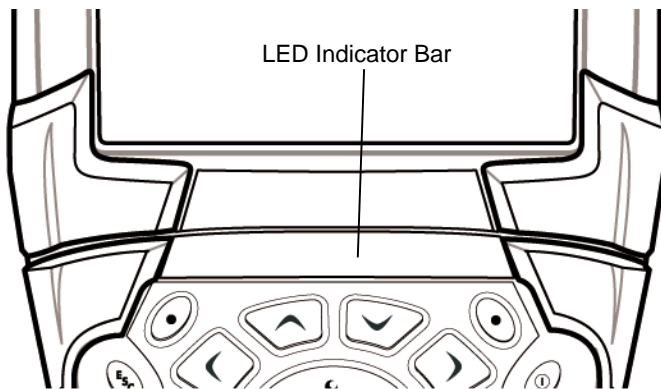

Figure 2-15 MC9190-G LEDs Indicator Bar

Table 2-9 MC9190-G LED Indications

LED State	Indication
Solid Red	Laser enabled, scanning/imaging in process.
Solid Green	Successful decode/capture.
Slow Blinking Amber	Main battery in MC9190-G is charging.
Fast Blinking Amber	Error in charging; check placement of the MC9190-G.
Solid Amber	Main battery in MC9190-G is fully charged.

Keypads

The MC9190-G has the following interchangeable modular keypads:

- 28-key keypad
- 43-key keypad
- 53-key keypad
- 3270 Emulator
- 5250 Emulator
- VT Emulator.

Refer [Appendix C, Keypads](#) to for detailed information on each keypad.

Entering Data

When entering data on the keypad, use either the single-hand method or the two-hand method as shown in [Figure 2-16](#).

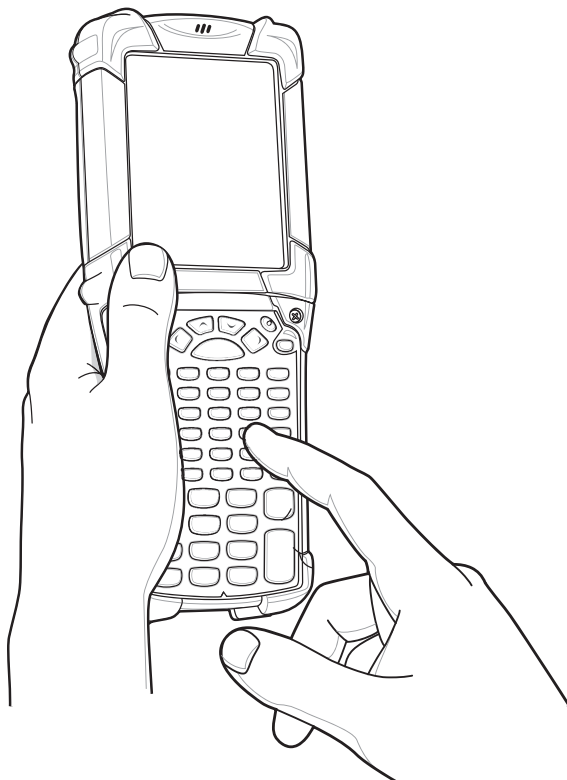

Single-hand Method

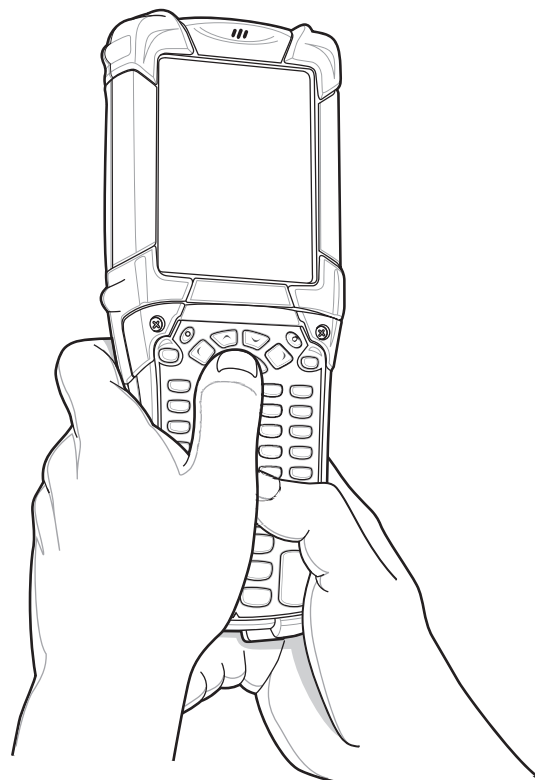

Two-hand Method

Figure 2-16 *Entering Data on the Keypad*

Using the Power Button

Press the red Power button to turn the MC9190-G screen on and off (suspend mode). The MC9190-G is on when the screen is on and the MC9190-G is in suspend mode when the screen is off. For more information, see [Starting the MC9190-G on page 1-5](#).

The Power button is also used to reset the MC9190-G by performing a warm or cold boot.

- On Windows CE 6.0
 - Warm Boot - Resets the MC9190-G.
 - Cold Boot - Resets the MC9190-G, removes all added applications and restores all factory default settings.
- On Windows Mobile 6.5
 - Warm Boot - Resets the MC9190-G. Operating system and all applications are restarted. File storage is preserved.
 - Cold Boot - Resets the MC9190-G. Operating system and all applications are restarted. File storage is preserved. Normally only used when a Warm Boot does not initiate.

✓ **NOTE** Applications that are added to the Application folder are not removed when a cold boot is performed. The Application folder is in flash memory.

For information about booting the MC9190-G, see [Windows Mobile 6.5 Devices on page 2-23](#).

Wireless LAN

✓ **NOTE** By default, the WLAN is off when the MC9190-G boots up. To set the WLAN radio to be on when the MC9190-G boots up, see the *MC9190-G Integrator Guide*.

To configure the MC9190-G, a set of wireless applications provide the tools to configure and test the wireless radio in the MC9190-G. Refer to the *Wireless Fusion Enterprise Mobility Suite User Guide for Version 3.00* for information on configuring wireless profiles. Go to <http://supportcentral.motorola.com> for the latest version of this guide. See [Software Versions on page x](#) to determine the Fusion version on the MC9190-G.

Windows CE Devices

Tap the **Signal Strength** icon to display the **Wireless Launcher** menu.



Signal Strength Icon

Figure 2-17 Wireless Application Menu

Windows Mobile 6.5 Devices

- ✓ **NOTE** On devices with Windows Mobile, access the Wireless launcher from the Home screen. Select the Fusion plug-in and then tap the **Fusion Menu** button.

The interface to the **Signal Strength** icon and **Wireless Launcher** has changed in the Windows Mobile 6.5 default Today screen. To view the **Wireless Launcher**, select the Fusion plug-in on the Today screen and tap the **Fusion Menu** soft key.



Figure 2-18 Fusion Plug-in on Today Screen

Functionality of this dialog is similar to the **Wireless Launch** menu. Drag the window up and down to view all menu items. Tap the icon next to the item to open it.



Figure 2-19 Wireless Launcher Window

Interactive Sensor Technology

This section describes the functionality of the Interactive Sensor Technology (IST) feature on the MC9190-G.

The IST supports the following features.

- Power Management – manage power by configuring IST to control switching on/off the backlight, control suspend mode of the MC9190-G by monitoring motion and orientation.
- Display Orientation – switch the screen orientation to either landscape or portrait depending on the MC9190-G orientation.
- Free Fall Detection – monitors free fall duration and records the time and type of the drop event.

Power Management

The MC9190-G orientation and motion sensitive data can be used as an indicator of MC9190-G usage and can be used to manage the battery power of the MC9190-G. For example, IST can be configured to control the backlight on and off functionality or go into suspend according to a user gesture by placing screen facing down. It can also be used to keep the MC9190-G active while it is in movement to prevent it from quickly going into suspend mode while in use.

Display Orientation

The screen can be rotated between portrait and landscape modes automatically, depending on the physical orientation of the MC9190-G. For example, if the MC9190-G is rotated 90° counterclockwise, IST rotates the display counterclockwise 90° so that the screen display appears correct.

This functionality is achieved by monitoring screen angle and rotating the display to counter any changes. IST only rotates the screen in multiples of 90°.

Free Fall Detection

IST continuously monitors gravitational force on the MC9190-G according to its current position. When the MC9190-G free falls, IST detects the absence of gravitational force and records the event data if it detects a free fall more than 450 ms, which may indicate nearly a one meter drop. This data can be used as an indicator of potential abuse or misuse.

IST features a log for recording the free fall events. This log records the date, time and the time period of the free fall.

Using a Wired Headset

You can use a stereo headset for audio communication when an audio enabled application is used. To use a headset, plug the headset jack into the audio connector on the side of the MC9190-G. Ensure that the MC9190-G's volume is set appropriately before putting the headset on. When a headset is plugged into the jack, the speakerphone is muted.

Motorola recommends a 2.5mm jack headset. See [Table 5-1 on page 5-1](#) for available Motorola headsets.

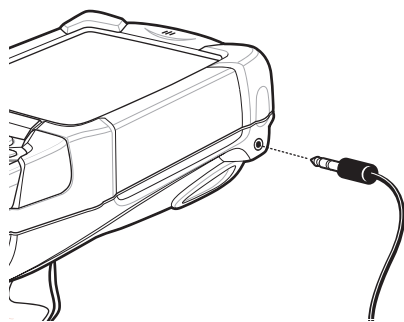

Figure 2-20 Using a Headset (MC9190-G Shown)

Using a Bluetooth Headset

You can use a Bluetooth headset for audio communication when an audio enabled application is used. See [Chapter 4, Using Bluetooth](#) for information on connecting a Bluetooth device to the MC9190-G. Ensure that the MC9190-G's volume is set appropriately before putting the headset on. When a Bluetooth headset is connected the speakerphone is muted.

Resetting the MC9190-G

Windows CE 6.0 Devices

There are two reset functions, warm boot and cold boot. A warm boot restarts the MC9190-G by closing all running programs.

A cold boot also restarts the MC9190-G, but erases all stored records and entries in RAM. Data saved in flash memory or a memory card is not lost. In addition it returns formats, preferences and other settings to the factory default settings.

Perform a warm boot first. This restarts the MC9190-G and saves all *stored* records and entries. If the MC9190-G still does not respond, perform a cold boot.

Performing a Warm Boot

Hold down the Power button for approximately five seconds. As soon as the MC9190-G starts to perform a warm boot release the Power button.

Performing a Cold Boot

A cold boot restarts the MC9190-G and erases all user stored records and entries that are not saved in flash memory (Application and Platform folders) or a memory card. *Never perform a cold boot unless a warm boot does not solve the problem.*



CAUTION Do not hold down any key, other than the Power button during a reset. Performing a cold boot restores formats, preferences and other settings to the default settings.



NOTE Any data previously synchronized with a computer can be restored during the next ActiveSync operation.

To perform a cold boot:

1. Press the primary battery release on the MC9190-G to partially eject the battery from the MC9190-G.
2. While the battery is partially released, simultaneously press and release the handle trigger and the Power button.
3. Push the battery to fully re-insert it in the MC9190-G. One audible click can be heard as the battery is fully inserted.
4. The MC9190-G initializes.
5. Calibrate the screen. See [Calibrating the Screen on page 1-6](#) to calibrate the MC9190-G screen.

Windows Mobile 6.5 Devices

There are two reset functions, warm boot and cold boot.

- A warm boot restarts the MC9190-G and closes all running programs.
- A cold boot also restarts the MC9190-G and closes all running programs but also installs some drivers.

Data saved in flash memory or a memory card is not lost. Perform a warm boot first. This restarts the MC9190-G and saves all *stored* records and entries. If the MC9190-G still does not respond, perform a cold boot.

Performing a Warm Boot

Hold down the Power button for approximately five seconds. As soon as the MC9190-G starts to perform a warm boot release the Power button.

Performing a Cold Boot

A cold boot restarts the MC9190-G. The operating system and all applications are restarted. File storage is preserved. *Only perform a cold boot if a warm boot does not solve the problem.*

To perform a cold boot:

1. Press the red **Power** button. The **PowerKey Action** window appears.
2. Tap **Safe Battery Swap**. The Indicator LED Bar lights red.
3. Press the primary battery release on the MC9190-G to partially eject the battery from the MC9190-G.
4. While the battery is partially released, simultaneously press and release the trigger and the Power button.

5. Push the battery to fully re-insert it in the MC9190-G. One audible click can be heard as the battery is fully inserted.
6. The MC9190-G initializes.

Battery Health

The health of the battery can be viewed on the MC9190-G Power applet. Tap **Start > Settings > Power icon > BatteryMgmt** tab.

Table 2-10 *BatteryMgmt Window*

Item	Description
State of Health	Indicates the current state of the battery (Healthy or Unhealthy).
Battery Usage Indicator	Indicates the usage of the battery.
Battery Usage Threshold	Indicates the usage indicator threshold.
Battery Serial #	Displays the serial number of the battery.

For information on changing the Battery Usage Threshold, refer to the *MC9191-G Mobile Computer Integrator Guide*.

Waking the MC9190-G

The wakeup conditions define what actions wake up the MC9190-G after it has gone into suspend mode. The MC9190-G can go into suspend mode by either pressing the Power button or automatically by Control Panel time-out settings. These settings are configurable and the factory default settings are shown in [Table 2-11](#).

Table 2-11 *Wakeup Default Settings*

Condition for Wakeup	Power Button	Automatic Time-out
AC power is applied.	No	Yes
MC9190-G is inserted into a cradle.	No	Yes
MC9190-G is removed from a cradle.	No	Yes
MC9190-G is connected to a serial device.	No	Yes
MC9190-G is connected to a USB device.	Yes	Yes
MC9190-G is disconnected from a USB device.	Yes	Yes
The scan triggered is pressed.	No	Yes
The screen is touched.	No	No
Bluetooth activity.	Yes	Yes
On Motion	No	Yes
USB Host	No	No

Table 2-11 *Wakeup Default Settings (Continued)*

Condition for Wakeup	Power Button	Automatic Time-out
Key is pressed.	No	Yes
Audio Jack	No	No
Audio Button	No	No

Chapter 3 Data Capture

The MC9190-G has integrated laser scanners or imagers that collect data by scanning bar codes.

- Standard Range Laser
- Long Range Laser
- Standard Range Imager (standard range, high density (DPM) or driver license)
- Long Range Imager.

Scan LED Indicators

The red/green Scan LED Indicators (located in the Indicator LED Bar) indicates the scan status. For the location of the Scan LED Indicators see, [Figure 1-1 on page 1-2](#).

Table 3-1 Scan LED Indicators

	Indication
Off	Not scanning.
Solid Red	Laser enabled, scanning in process.
Solid Green	Successful decode.

Laser Scanning

To read a bar code, a scan-enabled application is required. The MC9190-G with Windows Mobile contains the **DataWedge** application and MC9190-G with Windows CE contains the **DataWedge** and **ScanSamp2 Example** applications that allows the user to enable the scanner to decode bar code data and display the bar code content. See [DataWedge on page 3-5](#) for information on launching **DataWedge** and [ScanSamp2 Example on page 3-5](#) for launching **ScanSamp2 Example**.

1. Launch a scanning application or a sample scanning application (**DataWedge** or **ScanSamp2 Example**).
2. Point the exit window on the top of the MC9190-G at a bar code.

3. Press the trigger or scan button. Ensure the red scan beam covers the entire bar code. The Scan LED Indicators illuminate red to indicate that the laser is on. The Scan LED Indicators illuminate green and a beep sounds to indicate a successful decode.



Figure 3-1 Laser Aiming

4. Release the trigger or scan button.

Scanning Considerations

Scanning consists of; aim, scan and decode. Scanning performance can be optimized by considering the range and the scanning angle:

- Range

Any scanning device decodes well over a particular working range (minimum and maximum distances from the bar code). This range varies according to bar code density and scanning device optics.

Scanning within range brings quick and constant decodes; scanning too close or too far away prevents decodes. Move the scanner closer and further away to find the right working range for the bar codes being scanned. However, the situation is complicated by the availability of various integrated scanning modules. The best way to specify the appropriate working range per bar code density is through a chart called a decode zone for each scan module. A decode zone simply plots working range as a function of minimum element widths of bar code symbols.

- Angle

The scan angle is important for optimizing decode performance. When laser beams reflect directly back into the scanner from the bar code, this specular reflection can “blind” the scanner.

To avoid this, scan the bar code so that the beam does not bounce directly back. But do not scan at too sharp an angle; the scanner needs to collect scattered reflections from the scan to make a successful decode. Practice quickly shows what tolerances to work within.



NOTE Contact the Motorola Enterprise Mobility Support Center if chronic scanning difficulties develop. Decoding of properly printed bar codes should be quick and effortless.

Imaging

The MC9190-G with an integrated imager has the following features:

- Omnidirectional (360°) reading of a variety of bar code symbologies, including the most popular linear, postal, PDF417, and 2D matrix code types.
- The ability to capture and download images to a host for a variety of imaging applications.

- Advanced intuitive laser aiming for easy point-and-shoot operation.

The imager uses digital camera technology to take a digital picture of a bar code, stores the resulting image in its memory, and executes state-of-the-art software decoding algorithms to extract the data from the image.

Operational Modes

The MC9190-G with an integrated imager supports three modes of operation, listed below. Activate each mode pressing the Scan button.

- Decode Mode: In this mode, the MC9190-G attempts to locate and decode enabled bar codes within its field of view. The imager remains in this mode as long as you hold the scan button, or until it decodes a bar code.

✓ **NOTE** To enable Pick List Mode, use the CtlPanel applet on Windows CE or download the Windows Mobile Control Panel applet from the Support Central web site at <http://supportcentral.motorola.com>. Pick List can also be set in an application using a API command.

- Pick List Mode: This mode allows you to selectively decode a bar code when more than one bar code is in the MC9190-G's field of view. To accomplish this, move the aiming crosshair center dot over the required bar code to decode only that bar code. This feature is ideal for pick lists containing multiple bar codes and manufacturing or transport labels containing more than one bar code type (either 1D or 2D).
- Image Capture Mode: Use this mode to capture an image within the MC9190-G's field of view. This is useful for capturing signatures or images of items like damaged boxes.

Imager Scanning

To read a bar code, a scan-enabled application is required. The MC9190-G with Windows Mobile contains the **DataWedge** application and with Windows CE contains the ScanSamp2 application that allows the user to enable the scanner to decode bar code data and display the bar code content. See for information on launching DataWedge and for launching ScanSamp2.

1. Launch a scanning application or a sample scanning application (**DataWedge** or **ScanSamp2**).
2. Point the exit window on the top of the MC9190-G at a bar code.
3. Press the trigger or scan button. Ensure the red scan beam covers the entire bar code. The Scan LED Indicators illuminate red to indicate that the laser is on. The Scan LED Indicators illuminate green and a beep sounds to indicate a successful decode.

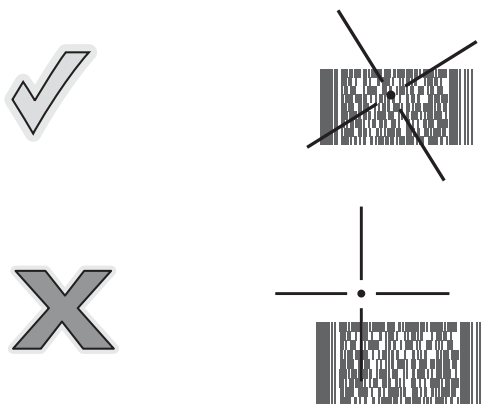

Figure 3-2 Standard Range Imager Aiming Pattern

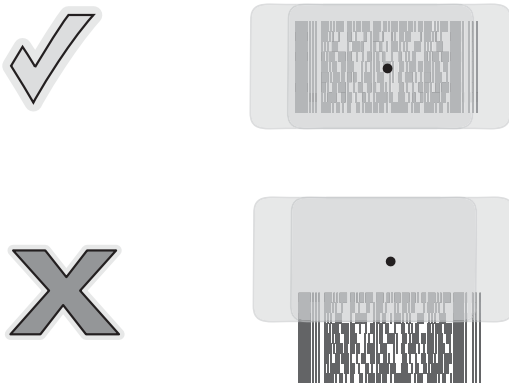

Figure 3-3 Long Range Imager Aiming Pattern



Figure 3-4 Standard Range Pick List Mode with Multiple Bar Codes



Figure 3-5 Long Range Pick List Mode with Multiple Bar Codes

4. Release the scan button.

Image Capture

To capture an image, an image capture application is required. The MC9190-G with Windows CE contains the ImagerSample application that allows the user to enable the scanner to capture an image and display the image. See for information on launching ImagerSample.

1. Launch an image capture application or the sample application (**ImagerSample**).
2. Point the exit window on the top of the MC9190-G toward the object to capture.

3. Press the trigger or scan button. The captured image appears on the screen.

DataWedge



NOTE By default, DataWedge is not installed on the MC9190-G. Refer to the *MC9190-G Integrator Guide* for installation instructions.

Enable DataWedge

To enable DataWedge:

1. On Windows Mobile, tap **Start > Settings > System > DataWedge**.
On Windows CE, tap **Start > Settings > Control Panel > DataWedge**.
2. Tap **Basic configuration > 1. Barcode input**.
3. Tap **1. 1D Scanner Driver** or **1. Block Buster Imager**.
4. Ensure that a check mark is next to **1. Enabled**. If not, tap **1. Enabled**.
5. Tap **OK**.
6. Tap **Running** to start the DataWedge process. The DataWedge Status changes to Ready.
7. Tap **OK**.

Disable DataWedge

To disable DataWedge:

1. On Windows Mobile, tap **Start > Settings > System > DataWedge**.
On Windows CE, tap **Start > Settings > Control Panel > DataWedge**.
2. Tap the **Running** option to end the DataWedge process. The DataWedge Status changes to **Stopped**.
3. Tap **OK**.

ScanSamp2 Example

To launch **ScanSamp2 Example**:

1. Tap **Start > Programs > Samples**.
2. Double-tap **Scan** icon.
3. Select the scan engine type and tap **OK**.

To exit the application, tap **Cancel**.

ImagerSample

To launch **ImagerSample**:

1. Tap **Start > Programs > Samples**.
2. Double-tap **Imager** icon.

To exit the application, tap **File > Exit**.

Using the RS507 Hands-free Imager

An RS507 Hands-free Imager can be used with the MC9190-G to capture bar code data.

✓ **NOTE** Only one RS507 can be paired with the MC9190-G at a time.

To set up the RS507:

1. Tap **Start > Programs > BTScannerCtlPanel** icon.
2. If required, select the **BT Scanner** checkbox and then select the appropriate Com port from the drop-down list.
3. Tap **Save and Exit**.
4. Tap **Start > Programs > BT Information**.
5. Tap **Generate Local BD Address Barcode**. A bar code displays.

✓ **NOTE** If the MC9190-G with Windows CE is set to VGA mode the RS507 cannot read the bar code due to the smaller bar code size. Refer to the *RS507 Hands-free Imager Product Reference Guide* for instruction for printing a pairing bar code.

6. Point the RS507 at the bar code. The RS507 reads the bar code and begins pairing with the MC9190-G.

Refer to the *RS507 Hands-free Imager Product Reference Guide* for more information.

Chapter 4 Using Bluetooth

Introduction

Bluetooth-equipped devices can communicate without wires, using frequency-hopping spread spectrum (FHSS) radio frequency (RF) to transmit and receive data in the 2.4 GHz Industry Scientific and Medical (ISM) band (802.15.1). Bluetooth wireless technology is specifically designed for short-range (32.8 feet/10 meters) communication and low power consumption.

MC9190-Gs with Bluetooth capabilities can exchange information (e.g., files, appointments, and tasks) with other Bluetooth enabled devices such as phones, printers, access points, and other mobile computers.

The MC9190-G with Bluetooth technology uses either the StoneStreet Bluetooth stack or the Microsoft Bluetooth stack. To write an application that uses the StoneStreet One Bluetooth stack APIs, refer to the Enterprise Mobility Developer Kit (EMDK) Help.

Adaptive Frequency Hopping

Adaptive Frequency Hopping (AFH) is a method of avoiding fixed frequency interferers, and can be used with Bluetooth voice. All devices in the piconet (Bluetooth network) must be AFH-capable in order for AFH to work. There is no AFH when connecting and discovering devices. Avoid making Bluetooth connections and discoveries during critical 802.11b communications. AFH for Bluetooth consists of four main sections:

- Channel Classification - A method of detecting an interference on a channel-by-channel basis, or pre-defined channel mask.
- Link Management - Coordinates and distributes the AFH information to the rest of the Bluetooth network.
- Hop Sequence Modification - Avoids interference by selectively reducing the number of hopping channels.
- Channel Maintenance - A method for periodically re-evaluating the channels.

When AFH is enabled, the Bluetooth radio “hops around” (instead of through) the 802.11b high-rate channels. AFH coexistence allows Motorola mobile computers to operate in any infrastructure.

The Bluetooth radio in this MC9190-G operates as a Class 2 device power class. The maximum output power is 2.5mW and the expected range is 32.8 feet (10 meters). A definition of ranges based on power class is difficult to obtain due to power and device differences, and whether one measures open space or closed office space.



NOTE It is not recommended to perform Bluetooth wireless technology inquiry when high rate 802.11b operation is required.

Security

The current Bluetooth specification defines security at the link level. Application-level security is not specified. This allows application developers to define security mechanisms tailored to their specific need. Link-level security occurs between devices, not users, while application-level security can be implemented on a per-user basis. The Bluetooth specification defines security algorithms and procedures needed to authenticate devices, and if needed, encrypt the data flowing on the link between the devices. Device authentication is a mandatory feature of Bluetooth while link encryption is optional.

Pairing of Bluetooth devices is accomplished by creating an initialization key that is used to authenticate the devices and create a link key for them. Entering a common PIN number in the devices being paired generates the initialization key. The PIN number is never sent over the air. By default, the Bluetooth stack responds with no key when a key is requested (it is up to user to respond to the key request event). Authentication of Bluetooth devices is based-upon a challenge-response transaction. Bluetooth allows for a PIN number or passkey that is used to create other 128-bit keys used for security and encryption. The encryption key is derived from the link key used to authenticate the pairing devices. Also worthy of note is the limited range and fast frequency hopping of the Bluetooth radios that makes long-distance eavesdropping difficult.

Recommendations are:

- Perform pairing in a secure environment
- Keep PIN codes private and don't store the PIN codes in the MC9190-G
- Implement application-level security.

The Microsoft stack supports Smart-pairing. For detailed information, refer to the Microsoft MSDN.

Security Mode 3 (Link Level Encryption)

The MC9190-G supports Security Level 3 (Link Level Encryption). Link level encryption is the data security process of encrypting information at the data link level as it is transmitted between two devices.

When using Microsoft Bluetooth Stack, set the link level encryption using an API call, API CALL GOES HERE. Refer to the Microsoft MSDN for more information.

When using StoneStreet One Bluetooth Stack, set **Encrypt Link On All Outgoing Connections** checkbox in the **Settings > Security** tab. Alternately set link level encryption using an API call, CALL GOES HERE. Refer to the Motorola EMDK for more information.

Bluetooth Configuration

By default, the MC9190-G is configured to using the Microsoft stack. Refer to the *MC9190-G Integrator Guide*, for information on switching between the Microsoft Bluetooth stack and the StoneStreet One Bluetooth stack.

Table 4-1 list the services supported by the StoneStreet One Bluetooth stack and the Microsoft Bluetooth stack.

Table 4-1 *Bluetooth Services*

Microsoft Bluetooth Stack		StoneStreet One Bluetooth Stack	
Windows Mobile	WinCE	Windows Mobile	WinCE
Serial Port Service	Serial Port Service	Serial Port Service	Serial Port Service
Dial-Up Networking Client Service		Dial-Up Networking Client Service	Dial-Up Networking Client Service
OBEX Object Push Service		OBEX Object Push Client and Host Services	OBEX Object Push Client and Host Services
HID Client Service		HID Client Services	HID Client Services
A2DP/AVRCP Service		LAN Client Services	LAN Client Services
		Headset Audio Gateway Client Services	Headset Audio Gateway Services
Personal Area Networking Services		Personal Area Networking Services	Personal Area Networking Services
		File Transfer Client and Host Services	File Transfer Client and Host Services
		A2DP/AVRCP Services	

Table 4-2 list the COM ports available for the StoneStreet One Bluetooth stack and the Microsoft Bluetooth stack.

Table 4-2 *COM Ports*

Microsoft Bluetooth Stack	StoneStreet One Bluetooth Stack
COM5	COM5
COM9	COM9
	COM11
	COM21
	COM22
	COM23

Bluetooth Power States

Cold Boot

With StoneStreet One Bluetooth Stack

Performing a cold boot on the MC9190-G turns off Bluetooth after initialization (which takes a few moments). It is normal to see the **Bluetooth** icon appear and disappear, as well as a wait cursor, when initialization proceeds in all modes.

With Microsoft Bluetooth Stack

Performing a cold boot retains the state of the Bluetooth radio prior to the cold boot.

Warm Boot

With StoneStreet One Bluetooth Stack

Performing a warm boot turns off Bluetooth.

With Microsoft Bluetooth Stack

Performing a warm boot retains the state of the Bluetooth radio prior to the warm boot.

Suspend

When there is an active Bluetooth connection, the Bluetooth radio goes into low power mode maintaining the active connection. When there is no active connection, the Bluetooth radio turns off.

With StoneStreet One Bluetooth Stack

- ✓ **NOTE** If there is an active Bluetooth connection between the MC9190-G and another Bluetooth device, the MC9190-G will not timeout. However, if the user presses the Power button on the MC9190-G, the MC9190-G will suspend and upon receiving data from a remote Bluetooth device, the MC9190-G will wake from suspend mode. For example, Bluetooth scanner sending data to the MC9190-G.

With Microsoft Bluetooth Stack

- ✓ **NOTE** If there is an active Bluetooth connection between the MC9190-G and another Bluetooth device and there is no data activity, the MC9190-G will timeout. However, if the user presses the Power button on the MC9190-G, the MC9190-G will suspend and upon receiving data from a remote Bluetooth device, the MC9190-G will wake from suspend mode. For example, headset redial or Bluetooth scanner sending data to the MC9190-G.

Resume

When the MC9190-G resumes, Bluetooth turns on if it was on prior to suspend.

Using Microsoft Bluetooth Stack with Windows Mobile 6.5

The following sections provide information on using the Microsoft Bluetooth stack with the Windows Mobile 6.5 operating system.

Turning the Bluetooth Radio Mode On and Off

Turn off the Bluetooth radio to save power or if entering an area with radio restrictions (e.g., an airplane). When the radio is off, other Bluetooth devices cannot see or connect to the MC9190-G. Turn on the Bluetooth radio to exchange information with other Bluetooth devices (within range). Communicate only with Bluetooth radios in close proximity.

✓ **NOTE** To achieve the best battery life turn off radios not in use.

Enabling Bluetooth

To enable Bluetooth:

1. Tap **Wireless Manager** and then tap the **Bluetooth** bar or
Tap **Start > Setting > Connections > Bluetooth** icon > **Mode** tab.
2. Check the **Turn On Bluetooth** checkbox.
3. Tap **ok**.

Disabling Bluetooth

To disable Bluetooth:

1. Tap **Wireless Manager** and then tap the **Bluetooth** bar or
Tap **Start > Setting > Connections > Bluetooth** icon > **Mode** tab.
2. Un-check the **Turn On Bluetooth** checkbox.
3. Tap **ok**.

Discovering Bluetooth Device(s)

The MC9190-G can receive information from discovered devices without bonding. However, once bonded, the MC9190-G and a bonded device exchange information automatically when you turn the Bluetooth radio on. See [Pairing with Discovered Device\(s\) on page 4-26](#) for more information.

To find Bluetooth devices in the area:

1. Ensure that Bluetooth is enabled on both devices.
2. Ensure that the Bluetooth device to discover is in discoverable and connectable modes.
3. Ensure that the two devices are within 30 feet (10 meters) of one another.
4. Tap **Start > Settings > Connections** tab > **Bluetooth** icon > **Devices** tab.
5. Tap **Add new device**. The MC9190-G begins searching for discoverable Bluetooth devices in the area.

6. Select a device from the list.
7. Tap **Next**.

✓ **NOTE** If Smart-pairing is configured and the device is requesting one of the pre-defined PINs, the **Enter Passcode** window does not appear.

8. Enter the Passcode on the other device. The device is added to the Bluetooth list.
You are prompted to enter a passcode. If the device has a specific passcode, enter it in the Passcode field and tap Next. If the device does not have a specific passcode, enter one in the Passcode field and tap Next. The Bluetooth radio tries to connect with the device.
9. If you created a passcode, you will be prompted by the other device to enter the same passcode. Enter the created passcode to establish a paired connection. (If you entered a passcode from the device, you shouldn't have to do anything on the other device.)
10. When the connection is complete, a list of matching and supported services on the device appears.
11. Select the services you want to use and tap Finish. The services on the new devices have to be selected or else the pairing won't include those services, even though the devices are paired. If services are not selected, you will be continually reprompted for the passcode from the device.
12. The device appears in the list on the main window.
After the passcodes have been accepted on both sides, you have a trusted ("paired") connection.

Available Services

✓ **NOTE** Some devices might not require a PIN. This depends upon the device's authentication.

The MC9190-G with Microsoft Bluetooth stack and Windows Mobile 6.5 offers the following services:

- OBEX Object Push via Beam
- Serial Port
- Personal Area Networking
- HID
- Dial-up Networking
- A2DP/AVRCP.

See the following sections for information on these services.

Object Push Services via Beam

✓ **NOTE** You can only send files to a remote device using the Beam function.

Use the OBEX Push Service to send files and contacts to another Bluetooth device. To transfer files between the MC9190-G and another Bluetooth enabled device:

1. Ensure that Bluetooth is enabled and discoverable on both devices.
2. Ensure that the two devices are within 30 feet (10 meters) of one another.

3. Tap **Start > Programs > File Explorer**.
4. Navigate to the file to transfer.
5. Tap and hold on the filename until the pop-up menu appears.

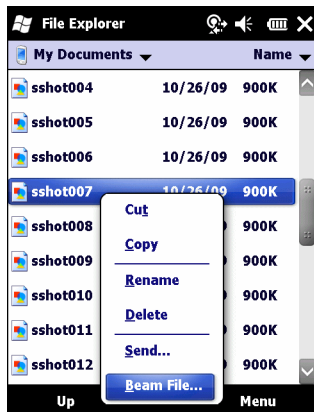

Figure 4-1 *File Explorer Window*

6. Select **Beam File**. The MC9190-G searches for Bluetooth devices in the area.
7. Tap **Tap to send** next to the Bluetooth device to send the file to. The MC9190-G communicates with the device and send the file. When completed, **Tap to send** changes to **Done**.

To transfer a contact between the MC9190-G and another Bluetooth enabled device:

1. Ensure that Bluetooth is enabled and discoverable on both devices.
2. Ensure that the two devices are within 30 feet (10 meters) of one another.
3. Tap **Start > Contacts**
4. Navigate to the contact to transfer.
5. Tap and hold on the contact until the pop-up menu appears.
6. Select **Send Contact > Beam**. The MC9190-G searches for Bluetooth devices in the area.
7. Tap **Tap to send** next to the Bluetooth device to send the file to. The MC9190-G communicates with the device and send the contact. When completed, **Tap to send** changes to **Done**.

Serial Port Services

Use the wireless Bluetooth serial port connection as you would a physical serial cable connection. Configure the application that will use the connection to the correct serial port.

To establish a serial port connection:

1. Ensure that Bluetooth is enabled and discoverable on both devices.
2. Ensure that the two devices are within 30 feet (10 meters) of one another.
3. Tap **Start > Settings > Connections** tab > **Bluetooth** icon > **Devices** tab.
4. Tap **Add new device**. The MC9190-G begins searching for discoverable Bluetooth devices in the area.
5. Select a device from the list.

6. Tap **Next**.

✓ **NOTE** If Smart-pairing is configured and the device is requesting one of the pre-defined PINs, the **Enter Passcode** window does not appear.

7. Enter the Passcode and the tap **Next**. The device is added to the Bluetooth list.

8. In the device list, tap the serial device. The **Partnership Settings** window displays.

9. Select the **Serial Port** checkbox.

10. Tap **Save**.

11. Tap **COM Ports** tab.

12. Tap **New Outgoing Port**.

13. Select the serial device in the list and then tap **Next**.

14. Select a COM port from the drop-down list.

15. Tap **Finish**.

✓ **NOTE** No connection is made at this point. An application must open the selected COM port to trigger Microsoft Bluetooth stack to open the connection.

ActiveSync Using Serial Port Services

Use the wireless Bluetooth serial port connection for ActiveSync just as you would a physical serial cable connection. You must configure the application that will use the connection to the correct serial port.

To set up a Bluetooth ActiveSync connection:

Before setting up a Bluetooth ActiveSync connection, configure the Bluetooth function of your device.

✓ **NOTE** For additional security, disable network bridging on the computer (specifically, bridging to a Remote NDIS adapter) before connecting to the computer to pass through to the Internet or a network. For more information on network bridging, see **Windows Help** on your computer.

The instructions below are for computers that support the Windows XP SP2 or later version operating system.

1. Ensure that Bluetooth is enabled and discoverable on both devices.
2. Ensure that the two devices are within 32.8 feet (10 meters) of one another.
3. On the computer, click **Start > Settings > Control Panel**.
4. Double-click **Bluetooth Devices**.
5. On the **Options** tab, select the **Turn discovery on** and **Allow Bluetooth devices to connect to this computer** checkboxes.

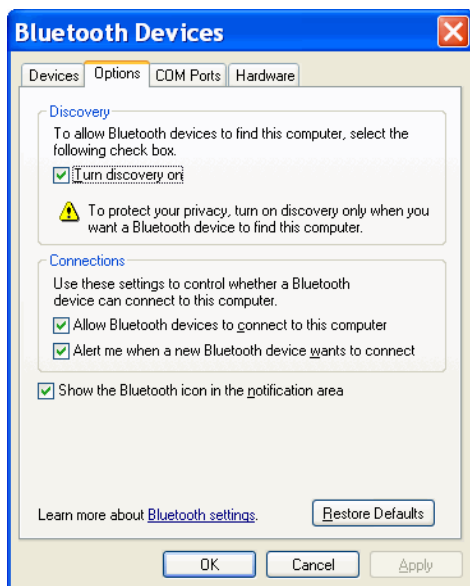

Figure 4-2 Computer Bluetooth Devices Window

6. On the **COM Ports** tab, click **Add**.
7. Select the **Incoming (device initiates the connection)** option, then click **OK**.
Note the number of the COM port that was added.
8. Click **OK**.
9. Click **Start > All Programs > Microsoft ActiveSync**.
10. Click **File > Connection Settings**.
11. On the **Allow connections to one of the following** drop-down list, select the COM port with the number you noted earlier.
12. On the MC9190-G, tap **Start > Programs > ActiveSync**.
13. Tap **Menu > Connect via Bluetooth**.
Synchronization is automatically initiated. The **ActiveSync** icon appears on the lower right corner of the **Today** screen.
If an Authentication is required, the **Enter Passcode** screen appears, type an alphanumeric passkey (PIN code), then tap **Next**; enter the same passkey on the other device.
The passkey is recommended for enhanced security. Your passkey must be between 1 to 16 alphanumeric characters.
If you do not want to use a passkey, tap **Next**.
14. To disconnect the ActiveSync connection, tap the **ActiveSync** icon on the Today screen.
15. Tap **Disconnect**.

Using Microsoft Bluetooth Stack with Windows CE 6.0

The following sections provide information on using the Microsoft Bluetooth stack with Windows CE 6.0 operating system.

Power Modes

The Bluetooth radio switches between normal and low power modes automatically. When data transfer is required, the radio goes into normal mode. After five seconds of inactivity, the radio goes into low power mode.

Discovering Bluetooth Device(s)

The MC9190-G can receive information from discovered devices without bonding. However, once bonded, the MC9190-G and a bonded device exchange information automatically when you turn the Bluetooth radio on. See [Pairing with Discovered Device\(s\) on page 4-26](#) for more information.

To find Bluetooth devices in the area:

1. Ensure that Bluetooth is enabled on both devices.
2. Ensure that the Bluetooth device to discover is in discoverable and connectable modes.
3. Ensure that the two devices are within 30 feet (10 meters) of one another.
4. Tap **Start > Settings > Control Panel > Bluetooth Device Properties** icon.



Figure 4-3 *Bluetooth Manager*

5. Tap **Scan Device** button. The MC9190-G begins searching for discoverable Bluetooth devices in the area. Discovered devices appear in the list.
6. Double-tap a device from the list. A pop-up menu appears.
7. Tap **Trusted**.
8. Tap **Yes**.
9. Enter a PIN and then tap **OK**.
10. Enter the PIN on the other device.

You are prompted to enter a PIN. If the device has a specific PIN, enter it in the PIN field and tap **Next**. If the device does not have a specific PIN, enter one in the PIN field and tap **Next**.
11. The device appears in the list on the main window with a key next to it.

After the PIN has been accepted on both sides, a trusted (“paired”) connection is created.

✓ **NOTE** Some devices might not require a PIN. This depends upon the device’s authentication.

Available Services

✓ **NOTE** In order to connect to the Bluetooth device, the application must create the connection to the remote device. Please refer to the MSDN Help for detailed information.

The MC9190-G with Microsoft Bluetooth stack and Windows CE 6.0 only supports the Serial Port service.

Using Bluetooth StoneStreet One Bluetooth Stack

The following sections provide information on using the Stone Street One Bluetooth stack.

Turning the Bluetooth Radio Mode On and Off

Turn off the Bluetooth radio to save power or if entering an area with radio restrictions (e.g., an airplane). When the radio is off, other Bluetooth devices cannot see or connect to the MC9190-G. Turn on the Bluetooth radio to exchange information with other Bluetooth devices (within range). Communicate only with Bluetooth radios in close proximity.



NOTE To achieve the best battery life turn off radios not in use.

Disabling Bluetooth (Windows CE 6.0)

To disable Bluetooth, tap **Bluetooth** icon > **Disable Bluetooth**. The **Bluetooth** icon changes to indicate that Bluetooth is disabled.

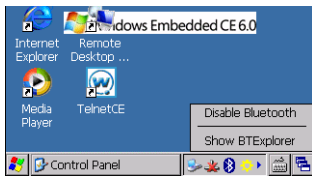

Figure 4-4 *Disable Bluetooth*

Enabling Bluetooth (Windows CE 6.0)

To enable Bluetooth, tap **Bluetooth** icon > **Enable Bluetooth**. The **Bluetooth** icon changes to indicate that Bluetooth is enabled.

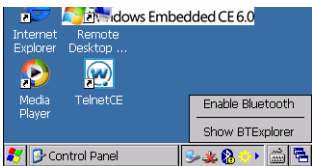

Figure 4-5 *Enable Bluetooth*

Disabling Bluetooth (Windows Mobile 6.5)

To disable Bluetooth, tap **Start** > **Settings** > **Connections** > **Wireless Manager**. Tap the **Bluetooth** bar to disable Bluetooth.

Enabling Bluetooth (Windows Mobile 6.5)

To enable Bluetooth, tap **Start** > **Settings** > **Connections** > **Wireless Manager**. Tap the **Bluetooth** bar to enable Bluetooth.

Modes

The BTE Explorer application has two modes for managing Bluetooth connections: Wizard Mode and Explorer Mode. The Wizard Mode is for novice Bluetooth users and the Explorer Mode is for experienced Bluetooth users. To switch between modes, select **View > Wizard Mode** or **View > Explorer Mode**.

Wizard Mode

Wizard Mode provides a simple process for discovering and connecting to Bluetooth devices.

✓ **NOTE** Switching between Wizard Mode and Explorer Mode closes all active connections.

Wizard Mode shows the devices and services in a simple Favorites view created by following the step-by-step wizard.

Explorer Mode

The **Explorer Mode** window is easy to navigate and provides greater control to users familiar with Bluetooth. The menu bar provides quick access to the options and tools used to connect to devices. To access Explorer Mode, tap **View > Explorer Mode**.

Also use the “tap and hold” technique to view available options. Scroll bars and view options are similar to those on the Windows desktop. The tree structure lists the following sub-items:

- Local Device - This device
- Remote Device - Other Bluetooth devices
 - Trusted Devices - Bonded (paired) Bluetooth devices
 - Untrusted Devices - Discovered devices that are not bonded
- Favorites - Selected services that are set as *Favorite* for quick access.

✓ **NOTE** Switching between Wizard Mode and Explorer Mode closes all active connections.

Discovering Bluetooth Device(s)

The MC9190-G can receive information from discovered devices without bonding. However, once bonded, the MC9190-G and a bonded device exchange information automatically when you turn the Bluetooth radio on. See [Pairing with Discovered Device\(s\) on page 4-26](#) for more information.

To find Bluetooth devices in the area:

1. Ensure that Bluetooth is enabled on both devices.
2. Ensure that the Bluetooth device to discover is in discoverable and connectable modes.
3. Ensure that the require profile is enabled on the MC9190-G. See [Profiles Tab on page 4-31](#) for more information.
4. Ensure that the two devices are within 30 feet (10 meters) of one another.
5. Tap the **Bluetooth** icon and select **Show BTE Explorer**.

- ✓ **NOTE** If favorite connections have already been created, the **Favorites** screen displays. If no favorite connections have been created, the **New Connection Wizard** screen displays.

6. Tap **Menu > New Connection**. The **New Connection Wizard** appears.

7. Select **Explore Services on Remote Device** or another from the drop-down list and tap **Next**.

The following actions are available in the drop-down list (actions may vary depending upon configurations):

- Explore Services on Remote Device
- Pair with a Remote Device
- Active Sync via Bluetooth
- Browse Files on Remote Device
- Connect to Headset
- Connect to Internet using Access Point
- Connect to Internet using Phone/Modem
- Connect to Personal Area Network
- Connect to Printer
- Send or Exchange Objects
- Associate Serial Port
- Connect to High-Quality Audio (not available on Windows CE 6.0 devices).

- ✓ **NOTE** If a device discovery action has not been previously performed, a device discovery is automatically initiated. If a device discovery has previously been performed, the device discovery process is skipped, and the previously found list of devices displays. To start a new device discovery, tap and hold in the window and select **Discover Devices** from the pop-up menu.

8. **BTE Explorer** searches for Bluetooth devices in the area.

The discovered devices display in the **Select Remote Device** window.

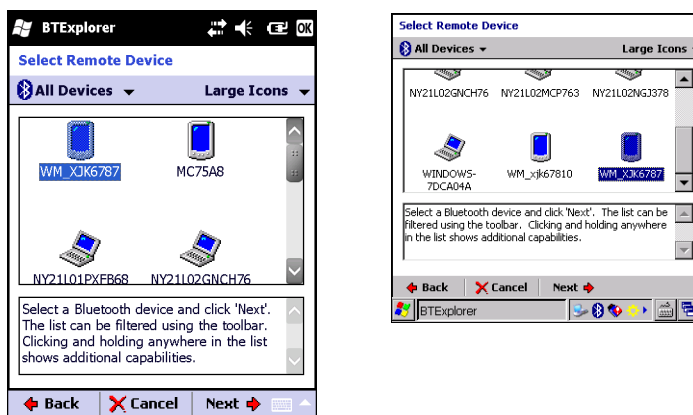

Figure 4-6 Select Remote Device Window

9. Select a device from the list and tap **Next**. The MC9190-G searches for services on the selected Bluetooth device.

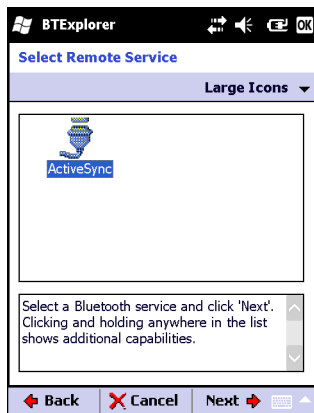

Figure 4-7 Device Services

✓ **NOTE** If the MC9190-G discovers a service but the service is not supported, the service icon is grayed-out.

10. Select a service from the list and press **Next**.



Figure 4-8 Connection Favorite Options Window

11. In the **Favorite Name** text box, enter a name for this service that will appear in the **Favorite** window. and then tap **Next**.

12. Tap **Connect** to add the service to the **Favorite** window and connect to the service.

Available Services

✓ **NOTE** Some devices might not require a PIN. This depends upon the device's authentication.

The MC9190-G offers the following services:

- File Transfer
- Dial-Up Networking
- OBEX Object Push

- Headset Audio Gateway
- Serial Port
- Personal Area Networking
- A2DP/AVRCP.

See the following sections for information on these services.

File Transfer Services

✓ **NOTE** Shared folders are a security risk.

To transfer files between the MC9190-G and another Bluetooth enabled device:

1. Ensure that OBEX File Transfer profile is enabled on the MC9190-G. See [Profiles Tab on page 4-31](#) for more information.

✓ **NOTE** If favorite connections have already been created, the **Favorites** screen displays. If no favorite connections have been created, the **New Connection Wizard** screen displays.

2. Use the **Connection Wizard** to search for a Bluetooth device.
3. Select the device and tap **Next**.
4. Tap **Next**.
5. Tap **Next**.
6. Tap **Connect**. The remote device's accessible folders appear.

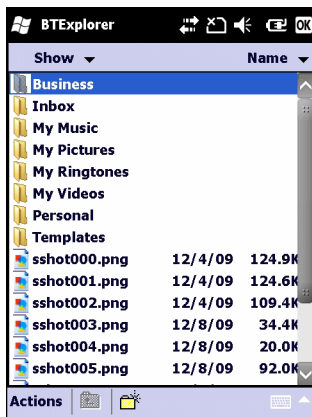

Figure 4-9 File Transfer Window

7. Tap and hold on the file. A pop-up menu appears.
8. Select the action to perform:
 - **New** - create a new file or folder on the remote device
 - **Delete** - delete the selected file on the remote device.
 - **Get File** - copy the file from the remote device to the MC9190-G.

- **Put File** - copy a file from the MC9190-G to the remote device.

Creating a New File or Folder

To create a new folder or file on the remote device:

1. Tap and hold on the screen and select **New > Folder** or **New > File**. The **Create New Folder** or **Create New File** window appears.
2. Enter the name for the new folder or file.
3. Tap **OK** to create the new folder or file on the remote device.

Deleting a File

To delete a file from the remote device:

1. Tap and hold on the file to delete and select **Delete**.
2. In the **Delete Remote Device File** dialog box tap **Yes**.

Getting a File

To copy a file from a remote device:

1. Double-tap or tap and hold on the file and select **Get**.
2. Navigate to the directory to save the file.
3. Tap **Save**. The file is transferred from the remote device to the MC9190-G.

Copying a File

To copy a file to a remote device:

1. Tap **Action > Put**.
2. Navigate to the directory to save the file and select a file.
3. Tap **Open**. The file copies from the MC9190-G to the remote device.

Connecting to the Internet Using an Access Point

This section explains how to access a Bluetooth-enabled LAN access point (AP) for a network connection. Use Internet Explorer to connect to a server.

1. Ensure the MC9190-G is discoverable and connectable. See [Device Info Tab on page 4-27](#).
2. Ensure that the **Personal Area Networking** profile is enabled on the MC9190-G. See [Profiles Tab on page 4-31](#) for more information.
3. Use the **Connection Wizard** to search for a Bluetooth AP.



NOTE If favorite connections have already been created, the **Favorites** screen displays. If no favorite connections have been created, the **New Connection Wizard** screen displays.

4. Select the **Personal Area Network** or **Network Access** service and select **Connect** from the pop-up menu. The MC9190-G connects with the access point.

5. Tap **Start > Internet Explorer**.
6. In the address field, enter an internet address and tap the **Enter** button. The web page loads.

✓ **NOTE** Network Access profile is not supported.

Dial-Up Networking Services

Dial-up networking allows the user to connect the MC9190-G to a Bluetooth Phone and use the Bluetooth Phone as a modem to connect to an office network or ISP.

Before setting up dial-up networking, obtain dial-up information and other necessary settings (username, password and domain name, if required) for the office network or ISP.

To create a new Bluetooth connection:

1. Ensure the Bluetooth Phone is discoverable and connectable.
2. Ensure that the **Dial-Up Networking** profile is enabled on the MC9190-G. See *Profiles Tab on page 4-31* for more information.
3. Tap **Menu > New Connection**.
4. Select **Explore Services on Remote Device** or another from the drop-down list and tap **Next**.
5. **BTE Explorer** searches for Bluetooth devices in the area.
The discovered devices display in the **Select Remote Device** window.
6. Select the Bluetooth Phone from the list and tap **Next**. The MC9190-G searches for services on the Bluetooth Phone.

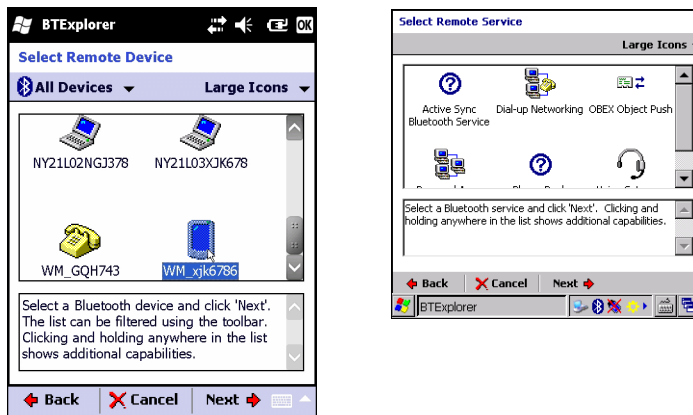

Figure 4-10 Select Remote Service Window

7. Select **Dial-up Networking Gateway** service from the list and tap **Next**.
8. In the **Favorite Name** text box, enter a name for this service that will appear in the **Favorite** window.
9. Tap **Next**.
10. Tap **Connect**.
11. Select the entry and tap **OK**. The MC9190-G begins to communicate with the Bluetooth phone. If required, the phone requests permission to communicate with the MC9190-G.

12. Confirm the connection on the phone.
13. In the **User name** text box, enter the user name for this connection.
14. In the **Password** text box, enter the password for this connection.
15. In the **Domain** text box, enter the domain name for this connection, if required.
16. Tap **Finish** or **Connect**.
17. The phone begins dialing and connects to the network.
18. To end a session, tap the **Connection** icon and then tap **Disconnect** in the dialog box.

Add a Dial-up Entry

To add a dial-up entry:

1. In the **Select Dial-up Networking Entry** window, tap and hold and then select **Add Entry** from the pop-up menu.
2. In the **Name for the connection** text box, enter a name for this connection.
3. In the **Country Code** text box, enter the country code for the country that you are calling.
4. In the **Area Code** text box, enter the area code.
5. In the **Phone Number** text box, enter the phone number.
6. Tap **OK**.

Object Exchange Push Services

Object Exchange (OBEX) is a set of protocols that allows sharing objects such as Contacts or pictures using Bluetooth.

To exchange contact information with another Bluetooth enabled device:

1. Ensure the MC9190-G is discoverable and connectable. See [Device Info Tab on page 4-27](#).
2. Ensure that the **OBEX Object Push** profile is enabled on the MC9190-G. See [Profiles Tab on page 4-31](#) for more information.

✓ **NOTE** If favorite connections have already been created, the **Favorites** screen displays. If no favorite connections have been created, the **New Connection Wizard** screen displays.

3. Use the **Connection Wizard** to search for a Bluetooth device.
4. Select the device and tap **Next**.
5. Select the **OBEX Object Push** service and select **Next**.
6. Tap **Next**.
7. Tap **Connect**.
8. In the **Action** drop-down list, select one of the following options: **Send Contact Information**, **Swap Contact Information**, **Fetch Contact Information**, or **Send a Picture**.

Sending a Contact

To send a contact to another device:

- ✓ **NOTE** Prior to sending and receiving contacts, a default contact must be set up before attempting to send a contact.

1. Tap and hold on **OBEX Object Push** and select **Connect**.



Figure 4-11 *OBEX Object Push Window*

2. In the **Action:** drop-down list, select **Send Contact Information**.
3. Tap



Figure 4-12 *Select Contact Entry Window*

4. Select a contact to send to the other device.
5. Tap **OK**.
6. Tap **OK** to send the contact to the other device and display a confirmation dialog box on the other device to accept the contact. A **Send Contact** dialog appears.
7. Tap **Ok**.

Swapping Contacts

To swap contacts with another device:

- ✓ **NOTE** Prior to swapping contacts, a default contact must be set up before attempting to send a contact.
Ensure that the MC9190-G is connectable.

1. Tap and hold on **OBEX Object Push** and select **Connect**.



Figure 4-13 OBEX Object Push Window

2. In the **Action:** drop-down list, select **Swap Contact Information**.
3. Tap .
4. Select a contact to send to the other device.
5. Tap **OK**.
6. Tap **OK** to swap contacts with the other device and display a confirmation dialog box on the other device to accept the contact.
7. Tap **Ok**.

Fetching a Contact

To fetch a contact from another device:

- ✓ **NOTE** Prior to sending and receiving contacts, a default contact must be set up before attempting to send a contact.
Ensure that the MC9190-G is connectable.

1. Tap and hold on **OBEX Object Push** and select **Connect**.



Figure 4-14 OBEX Object Push Window

2. In the **Action:** drop-down list, select **Fetch Contact information**.
3. Tap **OK**. The contact on the other device is copied.

Sending a Picture

To send a picture to another device:

1. Tap and hold on **OBEX Object Push** and select **Connect**.

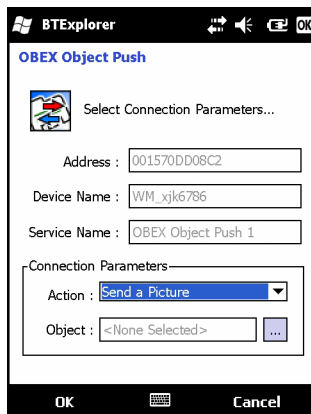



Figure 4-15 OBEX Object Push Window

2. In the **Action:** drop-down list, select **Send A Picture**.
3. Tap .

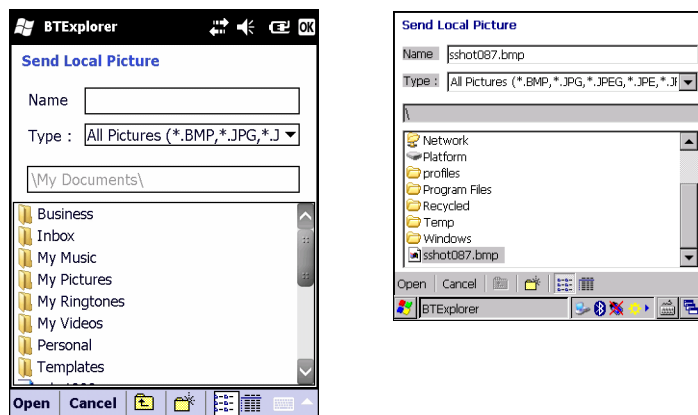

Figure 4-16 Send Local Picture Window

4. Navigate to the picture to send to the other device.
5. Tap **Open**.
6. Tap **OK** to send the picture to the other device and display a confirmation dialog box on the other device to accept the picture. A **Send Picture** dialog appears.
7. Tap **Ok**.

Headset Services

To connect to a Bluetooth headset:

✓ **NOTE** Newer Bluetooth headsets are device dependant and remember the last device they connected to. If problems occur while connecting to the headset, place the headset in discovery mode. Refer to the headset user manual for more information.

1. Ensure the MC9190-G is connectable (required when automatic re-connect is initiated). See [Device Info Tab on page 4-27](#).
2. Ensure that the **Headset** profile is enabled on the MC9190-G. See [Profiles Tab on page 4-31](#) for more information.
3. Use the **Connection Wizard** to search for a Bluetooth headset.
4. Select the device and tap **Next**.
5. Select the **Headset** service name and select **Connect**. The MC9190-G connects to the headset. Refer to the headset user manual for instructions on communicating with a Bluetooth device.

✓ **NOTE** When using a Bluetooth headset with Headset Services, you cannot accept or end a call from the headset. You must accept or end a call on the MC9190-G.

6. Press the communication button on the headset. This routes system audio to the headset.
7. Press the communication button on the headset to route the audio back to the MC9190-G.

Serial Port Services

Use the wireless Bluetooth serial port connection as you would a physical serial cable connection. Configure the application that will use the connection to the correct serial port.

To establish a serial port connection:

1. Use the **Connection Wizard** to search for a Bluetooth serial device.
2. Select the device and tap **Next**.
3. In the **Local COM Port:** drop-down list select a COM port.
4. Tap **Finish**.

ActiveSync Using Serial Port Services

- ✓ **NOTE** By default, COM ports COM5, COM9, COM11, COM21, COM22 and COM23 are Bluetooth virtual ports. If an application opens one of these ports, the Bluetooth driver activates and guides you through a Bluetooth connection.

Use the wireless Bluetooth serial port connection for ActiveSync just as you would a physical serial cable connection. You must configure the application that will use the connection to the correct serial port.



Figure 4-17 ActiveSync Connection Settings Window on PC

To establish an ActiveSync connection:

- ✓ **NOTE** When creating an ActiveSync connection, only use StoneStreet One Bluetooth Explorer in Wizard mode.

1. Use the **Connection Wizard** to search for a Bluetooth device, such as a PC. In the drop-down list select **ActiveSync via Bluetooth**.
2. Select the device and tap **Next**.
3. Tap **Connect**.



Figure 4-18 Remote Service Connection Window

4. In the **Service Type** drop-down list, select **Active Sync**.
5. Tap **OK**. The MC9190-G connects the PC and an ActiveSync session begins.
6. Tap **Finish**.
7. To end the session, tap the ActiveSync icon in the **Favorite** window and select **Disconnect** from the pop-up window.

Personal Area Network Services

✓ **NOTE** This profile supports Ad-hoc and PAN User. Network Access Profile is not supported.

Connect two or more Bluetooth devices to share files, collaborate, or play multi-player games. To establish a Personal Area Network connection:

1. Ensure that the **Personal Area Networking** profile is enabled on the MC9190-G. See [Profiles Tab on page 4-31](#) for more information.
2. Use the **Connection Wizard** to search for a Bluetooth device.
3. Select the device and tap **Next**.
4. Tap **Next**.
5. Tap **Connect**. The MC9190-G connects to the Bluetooth device.

A2DP/AVRCP Services

A2DP/AVRCP is used to connect to a high-quality stereo headset:

1. Ensure the MC9190-G is connectable (required when automatic re-connect is initiated). See [Device Info Tab on page 4-27](#).
2. Ensure that the remote Bluetooth device is in discoverable mode. See the devices user manual for instructions.
3. Ensure that the **A2DP/AVRCP** profile is enabled on the MC9190-G. See [Profiles Tab on page 4-31](#) for more information.

4. Tap **Menu > Settings > Services** tab.
5. Tap **Add** button.
6. Select **Advanced Audio Distribution Services**.
7. Tap **OK** three times.
8. Tap **Menu > New Connection**.
9. Select **Connect to High-Quality Audio** from the drop-down list.
10. Tap **Next**.
11. Select the device and tap **Next**.
12. Enter the PIN Code for the remote device and then tap **OK**.
13. Tap **Next**.
14. Tap **Connect**. The MC9190-G connects to the high-quality audio headset.

Connect to a HID Device

The MC9190-G can connect to an Human Interface Device (HID) device such as a Bluetooth keyboard:

1. Ensure the MC9190-G is connectable (required when automatic re-connect is initiated). See [Device Info Tab on page 4-27](#).
2. Ensure that the remote Bluetooth device is in discoverable mode. See the device user manual for instructions.
3. Ensure that the **HID Client** profile is enabled on the MC9190-G. See [Profiles Tab on page 4-31](#) for more information.
4. Tap **Menu > New Connection**.
5. Select **Explore Services on Remote Device** from the drop-down list.
6. Tap **Next**.
7. Select the device and tap **Next**.
8. Select the service and tap **Next**.
9. Tap **Next**.
10. Tap **Connect**. The MC9190-G connects to the HID device.

Pairing with Discovered Device(s)

Pairing is a relationship created between the MC9190-G and another Bluetooth device in order to exchange information in a secure manner. Pairing involves entering the same PIN on the two devices. After pairing and turning on the Bluetooth radios, the devices recognize the pairing and can exchange information without re-entering a PIN.

To pair with a discovered Bluetooth device:



NOTE If favorite connections have already been created, the **Favorites** screen displays. If no favorite connections have been created, the **New Connection Wizard** screen displays.

1. Tap the **Bluetooth** icon and select **Show BTE Explorer**.
2. Tap **Menu > New Connection**.
3. In the drop-down list, select **Pair with Remote Device**.
4. Tap **Next**.

✓ **NOTE** Devices discovered previously are listed to save time. To start a new device discovery, tap and hold on the list area and select **Discover Devices** from the pop-up menu.

5. Select a device from the list and tap **Next**.
6. In the **PIN Code** field, enter the PIN code.
7. Tap **OK**. The **Pairing Status** window displays.
8. Tap **Finish**. The devices are successfully paired. The device name moves to the **Trusted Devices** window.

Deleting a Paired Device

To delete a device no longer needed:

1. Tap the **Bluetooth** icon and select **Show BTE Explorer**.
2. Tap **Menu > Trusted Devices**.
3. Tap and hold on the device select **Delete Link Key** in the pop-up menu.
4. A confirmation dialog appears. Tap **Yes**.

Accepting a Pairing

When a remote device wants to pair with the MC9190-G, enter a PIN when requested to grant permission.

1. Ensure that the MC9190-G is set to discoverable and connectable. See [Bluetooth Settings on page 4-27](#). When prompted to pair with the remote device the **PIN Code Request** window appears.
2. In the **PIN Code:** text box, enter the same PIN entered on the device requesting the pairing. The PIN must be between 1 and 16 characters.
3. In the **Device Name:** text box, edit the name of the device requesting the pairing, if desired.
4. Tap **OK** to create the pairing. The MC9190-G can now exchange information with the other device.

Bluetooth Settings

Use the **BTE Explorer Settings** window to configure the operation of the **BTE Explorer** application. Tap **Menu > Settings**.

Device Info Tab

Use the **Device Info** tab to configure the MC9190-G's Bluetooth connection modes.

- **Device Name** - Displays the name of the MC9190-G.
- **Discoverable Mode** - Select whether or not the MC9190-G is discoverable by other Bluetooth devices.
- **Connectable Mode** - Select whether or not the MC9190-G is connectable by other Bluetooth devices.

Services Tab

- ✓ **NOTE** Ensure that the MC9190-G is discoverable and connectable when remote devices use MC9190-G services.

Use the **Services** tab to add or delete Bluetooth services.

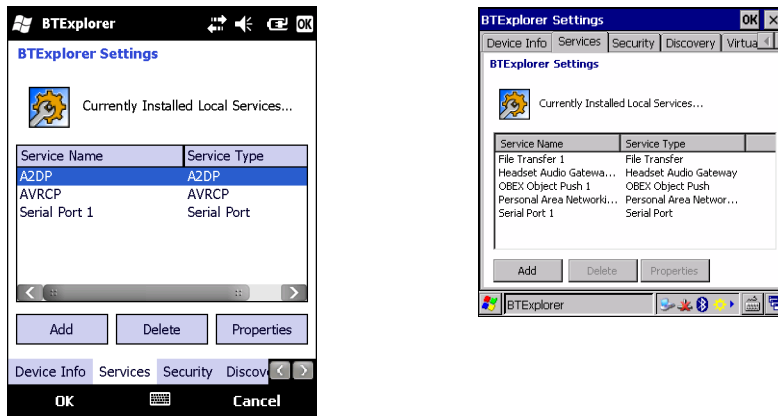

Figure 4-19 BTE Explorer Settings - Services Tab

To add a service:

1. Tap **Add**. The **Add Local Service** window displays.

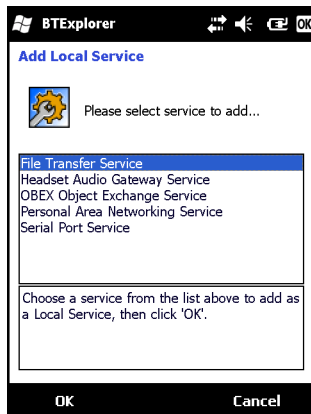

Figure 4-20 Add Local Service Window

2. In the list, select a service to add.
3. Tap **OK**. The **Edit Local Service** window displays for the selected service.
4. Select the appropriate information and then tap **OK**. See the following sections for information on the available services.

Dial-Up Networking Service

Dial-up Networking allows other Bluetooth devices to access a dial-up modem.

- **Service Name** - Displays the name of the service.

- **Service Security** - Select the type of security from the drop-down list. Options are **None**, **Authenticate**, or **Authenticate/Encrypt**.
- **Local COM Port** - Select the COM port.
- **Local Baud Rate** - Select the communication baud rate.
- **Local Port Options** - Select the port option.

File Transfer Service

File transfer allows other Bluetooth devices to browse files.

- **Service Name** - Displays the name of the service.
- **Service Security** - Select the type of security from the drop-down list. Options are **None**, **Authenticate**, or **Authenticate/Encrypt**.
- **Root Directory** - Select the directory that other Bluetooth devices can access.
- **File Permissions** - Select the file permissions for the selected directory. Check the appropriate box to grant read access, write access, and delete access.

Headset Audio Gateway Service

Headset Service Audio Gateway allows connection to headset devices.

- **Service Name** - Lists the name of the audio service.

OBEX Object Push Service

OBEX Object Push allows other Bluetooth devices to push contacts, business cards, pictures, appointments, and tasks to the MC9190-G.

- **Service Name** - Displays the name of the service.
- **Service Security** - Select the type of security from the drop-down list. Options are **None**, **Authenticate**, or **Authenticate/Encrypt**.
- **Do not allow clients to push objects** - Disables clients from pushing objects to the MC9190-G.
- **Inbox Directory** - Select a directory where another Bluetooth device can store files.

Personal Area Networking Service

Personal Area Networking hosts a Personal Area Network which allows communication with other Bluetooth devices.

- **Service Name** - Displays the name of the service.
- **Service Security** - Select the type of security from the drop-down list. Options are **None**, **Authenticate**, or **Authenticate/Encrypt**.
- **Support Group Ad-Hoc Networking** - Select to enable Ad-Hoc networking.

Serial Port Service

Serial port allows other Bluetooth devices to access COM ports.

- **Service Name** - Displays the name of the service.

- **Service Security** - Select the type of security from the drop-down list. Options are **None**, **Authenticate**, or **Authenticate/Encrypt**.
- **Local COM Port** - Select the COM port.
- **Local Baud Rate** - Select the communication baud rate.
- **Local Port Options** - Select the port option.

Advanced Audio Distribution Service

Advanced Audio Distribution hosts connects from Bluetooth devices supporting high-quality stereo audio.

- **Service Name** - Lists the name of the audio service.

Audio Video Remote Control Service

Audio Video Remote Control hosts connections from Bluetooth devices supporting audio remote-control functionality.

- **Service Name** - Lists the name of the audio service.

Security Tab

Security settings allows you to set global security policies for Bluetooth. Note that these settings are only active on local Services that are set to Authenticate or Authenticate/Encryption. You can set authentication on local Services under the Services tab.

To adjust the security settings for an individual service, select the **Services** tab first, then select the individual service, then **Properties**.



NOTE To use PIN Code, select **Authenticate** or **Authenticate/Encrypt** from the Service Security drop-down list on each local service.

- **Use PIN Code (Incoming Connection)** - Select for automatic use of the PIN code entered in the **PIN Code** text box. It is recommended not to use this automatic PIN code feature. See [Security on page 4-2](#) for more information.
- **PIN Code** - Enter the PIN code.
- **Encrypt Link On All Outgoing Connections** - Select to enable or disable encryption on all outgoing connections to other Bluetooth devices.

Discovery Tab

Use the **Discovery** tab to set and modify discovered devices.

- **Inquiry Length** - Sets the amount of time the MC9190-G takes to discover Bluetooth devices in the area.
- **Name Discovery Mode** - Select either **Automatic** or **Manual** to automatically attempt to discover a Bluetooth device's name after finding the device.
- **Discovered Devices - Delete Devices** - Deletes all discovered devices and link keys from memory.
- **Discovered Devices - Delete Linked Keys** - Removes all pairing from remote Bluetooth devices, and makes them all un-trusted.

Virtual COM Port Tab

Virtual COM Port defines which COM ports BTE Explorer attempts to use for virtual COM ports. Check the appropriate checkbox to use the port as a virtual COM port. When finished, choose **Apply** to enforce changes, or **Revert** to restore the original settings.

- **COM5:Bluetooth** - Enable or disable COM Port 5.
- **COM9:Bluetooth** - Enable or disable COM Port 9.
- **COM11:Bluetooth** - Enable or disable COM Port 11.
- **COM21:Bluetooth** - Enable or disable COM Port 21.
- **COM22:Bluetooth** - Enable or disable COM Port 22.
- **COM23:Bluetooth** - Enable or disable COM Port 23.

HID Tab

Use the **HID** tab to select The Human Interface Device Profile programming interface defines the protocols and procedures to be used to implement HID capabilities.

Provides support for devices such as mice, joysticks, keyboards.

- **Enable Key Repeat** - Enables key repeat functionality.
- **Delay** - To increase key repeat delay, drag the **Delay** slider to the right. To decrease key repeat delay, drag the **Delay** slider to the left.
- **Rate** - To increase key repeat speed, drag the **Rate** slider to the left. To decrease key repeat speed, drag the **Rate** slider to the right.

Profiles Tab

Use the **Profile** tab to load or remove Bluetooth services profiles. If a profile is not used, it can be removed to save memory.

1. Tap a check box next to the profile to load (activate).
The Serial Port profile is always active and cannot be removed.
2. Tap **Select All** to select all profiles or tap **Deselect All** to deselect all profiles.
3. Tap **Apply** to activate the profiles and then **Close** to exit the application.

System Parameters Tab

- **Page Timeout** - Sets the amount of time the MC9190-G searches for a device before moving on the next device.
- **Link Supervision Timeout** - Sets the amount of time that the MC9190-G will wait for a device to come back into range after it has gone out of range. If the device does not come back into range by the set time, the MC9190-G drops the connection.

Miscellaneous Tab

- **Highlight Connections** - Select the connection type to highlight when connected. In the Wizard Mode, the only options are *Favorites* or *None*. In the Explorer Mode the options are **None**, **Tree View Only**, **List View Only**, or **Tree and List View**.

- **Apply Text Style** - Select the text style to apply to the connection text.
- **Apply Text Color** - Select the text color to apply to the connection text.

Chapter 5 Accessories

Introduction

The MC9190-G accessories provide a variety of product support capabilities. [Table 5-1](#) lists the accessories available.

Table 5-1 MC9190-G Accessories

Accessory	Part Number	Description
Cradles		
Single Slot Serial/USB Cradle	CRD9000-1001SR	Charges the MC9190-G main battery and a spare battery. It also synchronizes the MC9190-G with a host computer through either a serial or a USB connection.
Four Slot Charge Only Cradle	CHS9000-4001CR	Charges the MC9190-G main battery.
Four Slot Ethernet Cradle	CRD9000-4001ER	Charges the MC9190-G main battery and synchronizes the MC9190-G with a host computer through an Ethernet connection.
Forklift Cradle	FLC9000-1000R	Provides secure mounting solution for the MC9190-G. The cradle is equipped with rugged RS232 and USB ports which are capable of powering and communicating with tethered devices.
Chargers		
Four Slot Spare Battery Charger	SAC9000-4000R	Charges up to four MC9190-G spare batteries.
Universal Battery Charger Adapter	21-32665-48R	Charges an spare battery as a stand-alone charger or with the UBC2000 base.
UBC Four Slot Base	UBC2000-I500DR	Charges up to four batteries using the UBC adapter.

Table 5-1 MC9190-G Accessories

Accessory	Part Number	Description
12 Volt Auto Charge Cable	VCA9001-12R	Plugs into a 12 volt cigarette lighter to charge the MC9190-G while on the road.
24 Volt Auto Charge Cable	VCA9000-24R	Plugs into a 24 volt cigarette lighter to charge the MC9190-G while on the road.
Spare lithium-ion battery	KT-2161261-01	Replacement battery.
UBC Adapter Power Supply Kit	KT-32665-02R	Provides power to the UBC adapter.
Power Supply	KT-14000-148R	Provides power to the Single Slot Serial/USB cradle. 100 - 240 VAC input, 12 VDC 3.33 A output.
Power Supply	PWRS-14000-148R	
Power Supply	PWRS-14000-242R	85 - 264 VAC input, 12 VDC 3.33 A output.
Power Supply	PWRS-14000-241R	Provides power to the Four Slot Charge Only cradle and Four Slot Ethernet cradle. 90 - 264 VAC input, 12 VDC 9 A output.
Cables		
DC Line Cord	50-16002-029R	Provides power from the power supply to the Four Slot Charge Only and Ethernet cradles.
DC Line Cord	25-72614-01R	
USB Sync Cable	25-64396-01R	Provides USB communication with a host computer through the Single Slot Serial/USB cradle.
RS232 Cable	25-62164-01R	Provides serial communication to the host computer or printer and can be used for AC charging.
USB Cable	25-62166-01R	Provides USB communication to the host.
DEX Cable with Floating Jack Screws	25-62167-03R	
Paxar Printer Cable	25-62168-01R	Connects the MC9100-G to a Paxar printer.
O'Neil Printer Cable	25-62169-01R	Connects the MC9190-G to an O'Neil printer.
Zebra Printer Cable	25-62170-02R	Connects the MC9190-G to a Zebra printer.
Modem Cable	25-63856-01R	Allows the Single Slot Serial/USB cradle to be used as a modem cradle.
Serial Cable	25-63852-01R	Provides serial communication from the Single Slot Serial/USB cradle to a host computer.
USB Cable	25-71918-01R	USB cable for FLC9000-1000R.
Serial Cable	25-71917-01R	Serial cable for FLC9000-1000R.

Table 5-1 MC9190-G Accessories

Accessory	Part Number	Description
Soft Goods		
Holster	SG-MC91212112-01R	Holds the MC9190-G when not in use.
Belt	11-08062-02R	For use with holster.
Protective Boot	11-67218-04R	Provides additional protection for MC90XX-G configurations.
Shoulder Strap	58-40000-007R	Universal shoulder strap for holster.
Snap-on		
Cable Adapter Module (CAM)	ADP9000-110R	Attaches to the bottom of the MC9190-G and provides power (5 VDC 350 mA) for use with the LS3408ER scanner.
Cable Adapter Module (CAM)	ADP9000-100R	Attaches to the bottom of the MC9190-G and provides power for operating charge charging the MC9190-G and provides serial communication.
Magnetic Stripe Reader (MSR)	MSR9001-100R	Snaps on to the MC9190-G and adds magstripe read capabilities.
Modem Dongle	MDM9000-100R	Provides modem connectivity through the MC9100-G or the Single Slot Serial/USB cradle.
Miscellaneous		
MC90XX Wall Mounting Bracket	KT-61498-01R	Order one for Single Slot cradle and one for the SAC9000. Order two for Four Slot Cradles. Order Cradle Bracket separately to attach to the wall mount bracket.
MC90XX Cradle Bracket	KT-61499-01R	Order one for Single Slot cradle and one for the SAC9000. Order two for Four Slot Cradles. Attaches to the bottom of the cradle.
Screen Protector	KT-93176-03R	Adds an additional level of protection for the MC90XX screen to protect against scratches. (3-pack).
Stylus Kit	KT-81680-50R	Replacement gray stylus with tether for MC9190-G (50-pack).
Stylus Kit	KT-81680-03R	Replacement gray stylus with tether for MC9190-G (3-pack).
Belt Clip	KT-70147-01R	Attaches to a user's belt.
VXI Headset	50-11300-050R	Wired plug-in headset for superior and convenient use.

Table 5-1 *MC9190-G Accessories*

Accessory	Part Number	Description
Rugged Cable Headset	RCH50	Rugged headset
RCH50 Adapter Cable	25-124387-01R	RCH50 adapter cable for standard 3-pole, 2.5mm barrel jack used with MC9190-G.
UBC2000 Wall Mount Kit	KT-32665-01R	Use for mounting UBC2000 onto a wall.

Secure Device (SD) Card

The SD card provides secondary non-volatile storage. The SD card is located under the keypad.



CAUTION Do not remove the keypad while the MC9190-G is on and do not operate the MC9190-G with the keypad detached. Follow proper ESD precautions to avoid damaging the SD card. Proper ESD precautions include, but are not limited to, working on an ESD mat and ensuring that the operator is properly grounded.

To insert the SD card:

1. Suspend the MC9190-G.
2. Remove the two keypad screws and slide the keypad down and lift off.
3. Lift the SD card retaining door.
4. Position the SD card, with the contacts down, into the SD card holder. The SD card corner notch fits into the holder only one way. Snap the retaining door closed.

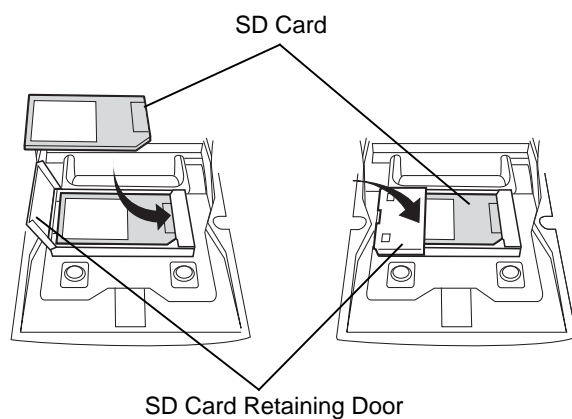

Figure 5-1 *Inserting the SD Card*



CAUTION Do not apply more than 4 in-lbs of torque when tightening the keypad screws.

5. Replace the keypad and re-attach using the two screws.
6. Perform a warm boot.

Single Slot Serial/USB Cradle



CAUTION Ensure that you follow the guidelines for battery safety described in *Battery Safety Guidelines on page 6-1*.

This section describes how to use a single Single Slot Serial/USB cradle (*Figure 5-2*) with the MC9190-G. For serial and USB communication setup procedures refer to the *MC9190-G Integrator Guide*.

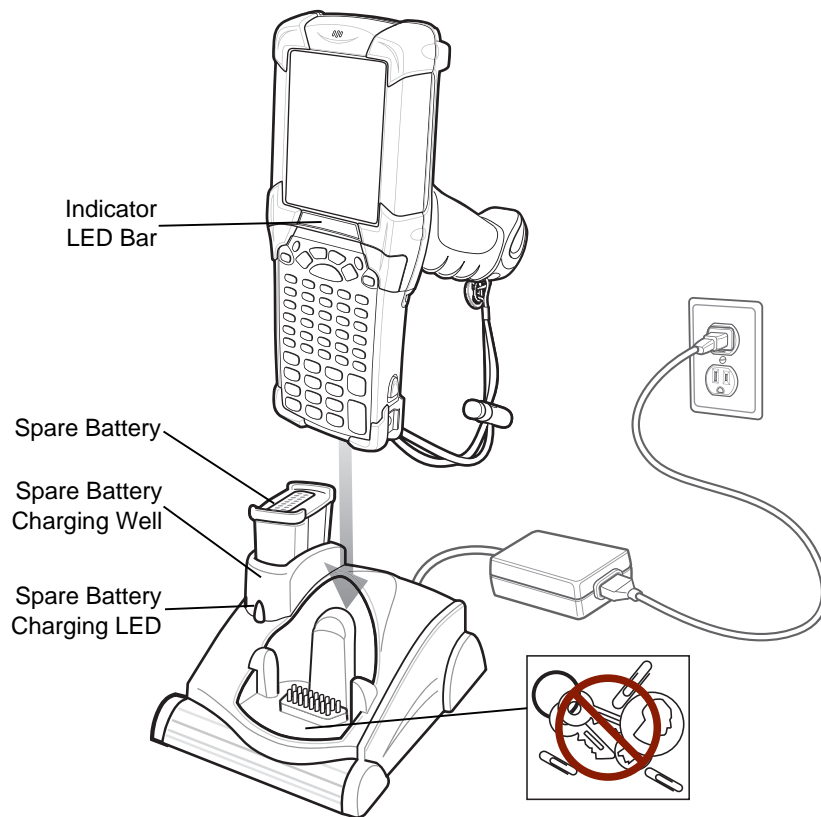

Figure 5-2 Single Slot Serial/USB Cradle



CAUTION Do not place coins, keys or paper clips in cradle well.

The Single Slot Serial/USB Cradle has the following attributes:

- Provides 12 VDC power for operating the MC9190-G.
- Provides serial and USB ports for data communication between the MC9190-G and a host computer or other serial devices (e.g., a printer).



NOTE When a MC9190-G with Microsoft Mobile 6.5 is placed in the cradle and an ActiveSync connection is made, the WLAN radio (if applicable) is disabled. This is a Microsoft security feature to prevent connection to two networks at the same time.

- Synchronizes information between the MC9190-G and a host computer. (With customized or third party software, it can also be used to synchronize the MC9190-G with corporate databases.)
- Charges the MC9190-G's battery.
- Charges a spare battery.

The the Single Slot Serial/USB Cradle can charge the MC9190-G's main battery and a spare battery simultaneously.

The MC9190-G's amber charge LED, located in the Indicator LED Bar, shows the status of the battery charging in the MC9190-G. See [Table 1-1 on page 1-4](#) for charging status indications.

The amber spare battery charging LED on the cradle (see [Figure 5-2 on page 5-6](#)) shows the status of the spare battery charging in the cradle. See [Table 5-3](#) for charging status indications.

Batteries usually charge in less than four hours.

Table 5-2 Spare Battery LED Charging Indicators

Spare Battery LED (on cradle)	Indication
Off	No spare battery in well; spare battery not placed correctly; cradle is not powered.
Fast Blinking Amber	Error in charging; check placement of spare battery.
Slow Blinking Amber	Spare battery is charging.
Solid Amber	Charging complete.

Four Slot Ethernet Cradle



CAUTION Ensure that you follow the guidelines for battery safety described in [Battery Safety Guidelines on page 6-1](#).

This section describes how to use a Four Slot Ethernet cradle with the MC9190-G.

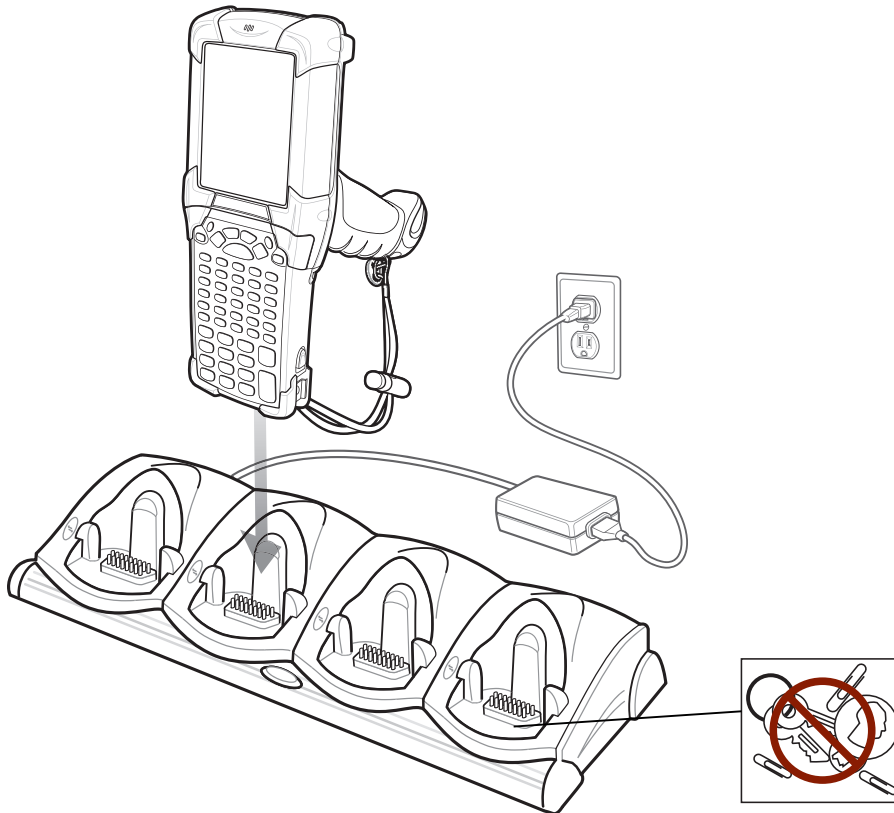

Figure 5-3 Four Slot Ethernet Cradle



CAUTION Do not place coins, keys or paper clips in cradle well.

The Four Slot Ethernet cradle:

- Provides 12 VDC power for operating the MC9190-G.
- Enables data communication between the MC9190-G (up to four) and a host computer, over an Ethernet network (using a standard 10Base-T Ethernet cable).
- Synchronizes information between the MC9190-G and a host computer. (With customized or third party software, it can also be used to synchronize the MC9190-G with corporate databases.)
- Simultaneously charges up to four batteries in the MC9190-G.

The MC9190-G's amber charge LED, located in the Indicator LED Bar, shows the status of the battery charging in the MC9190-G. See [Table 1-1 on page 1-4](#) for charging status indications.

The battery usually charges in less than four hours.

Four Slot Charge Only Cradle



CAUTION Ensure that you follow the guidelines for battery safety described in [Battery Safety Guidelines on page 6-1](#).

This section describes how to use a Four Slot Charge Only cradle with the MC9190-G.

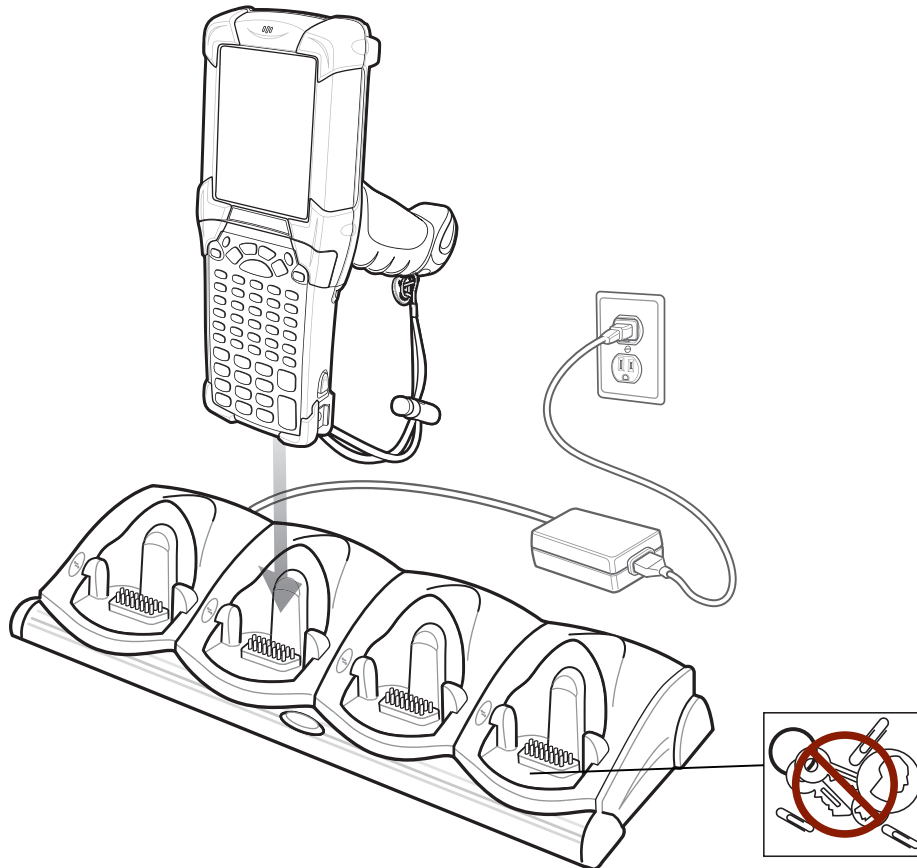

Figure 5-4 Four Slot Charge Only Cradle



CAUTION Do not place coins, keys or paper clips in cradle well.

The Four Slot Charge Only cradle:

- Provides 12 VDC power for operating the MC9190-G.
- Simultaneously charges up to four batteries in the MC9190-G.

The MC9190-G's amber charge LED, located in the Indicator LED Bar, shows the status of the battery charging in the MC9190-G. See [Table 1-1 on page 1-4](#) for charging status indications.

The battery usually charges in less than four hours.

Four Slot Spare Battery Charger



CAUTION Ensure that you follow the guidelines for battery safety described in [Battery Safety Guidelines on page 6-1](#).

This section describes how to use the Four Slot Spare Battery Charger to charge up to four MC9190 spare batteries.

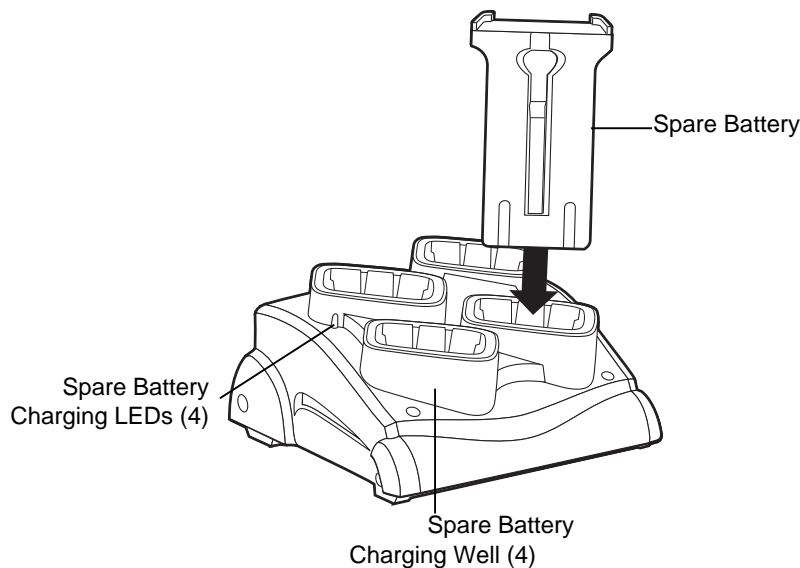

Figure 5-5 Four Slot Spare Battery Charger

Insert the battery into a spare battery charging slot and gently press down on the battery to ensure proper contact. An amber LED is provided on each battery charging well. See [Table 5-2](#) for charging status indications. The battery usually charges in less than four hours.

Table 5-3 Spare Battery LED Charging Indicators

LED	Indication
Off	No spare battery in slot; spare battery not placed correctly; cradle is not powered.
Fast Blinking Amber	Error in charging; check placement of spare battery.
Slow Blinking Amber	Spare battery is charging.
Solid Amber	Charging complete.

Magnetic Stripe Reader

This section describes how to set up and use the snap-on MSR with the MC9190-G. The MSR snaps on to the bottom of the MC9190-G and can be easily removed when not in use.

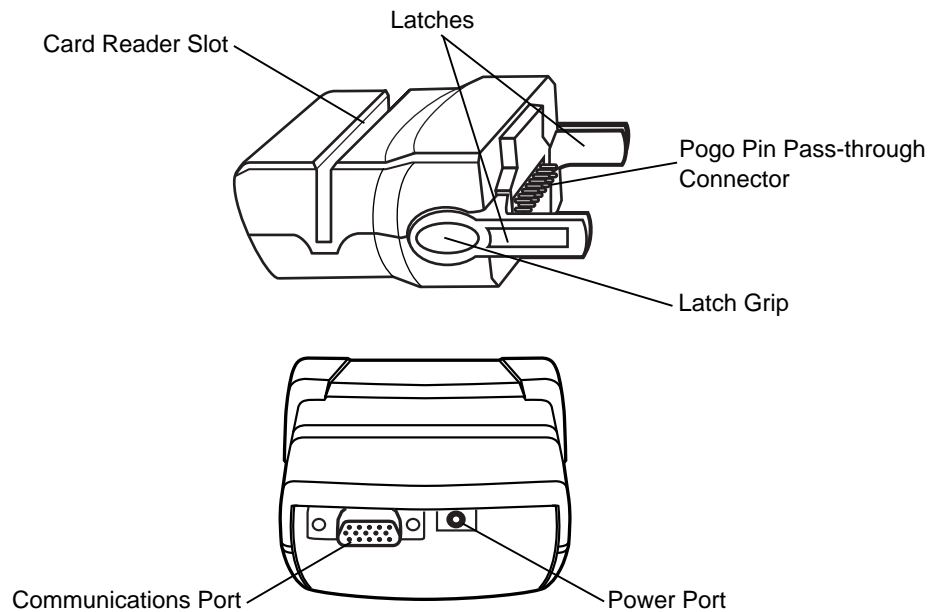

Figure 5-6 *Magnetic Stripe Reader*

When attached to the MC9190-G, the MSR:

- Provides power for operating the MC9190-G, with the appropriate power connection.
 - Allows the MC9190-G to capture data from magnetic stripe cards. (To download MSR data capture software, visit: <http://supportcentral.motorola.com>.)
- ✓ **NOTE** When a MC9190-G with Windows Mobile 6.5 is connected to a host computer through the MSR and an ActiveSync connection is made, the WLAN radio (if applicable) are disabled. This is a Microsoft security feature to prevent connection to two networks at the same time.
- Provides serial connection through the serial pass-through port for communication with a serial device, such as a host computer.
 - Provides USB connection through the USB pass-through port for communication with a USB device, such as a host computer.
 - Charges the MC9190-G's battery, when used with the appropriate power supply.

Attaching and Removing

To attach, snap the MSR onto the bottom of the MC9190-G.

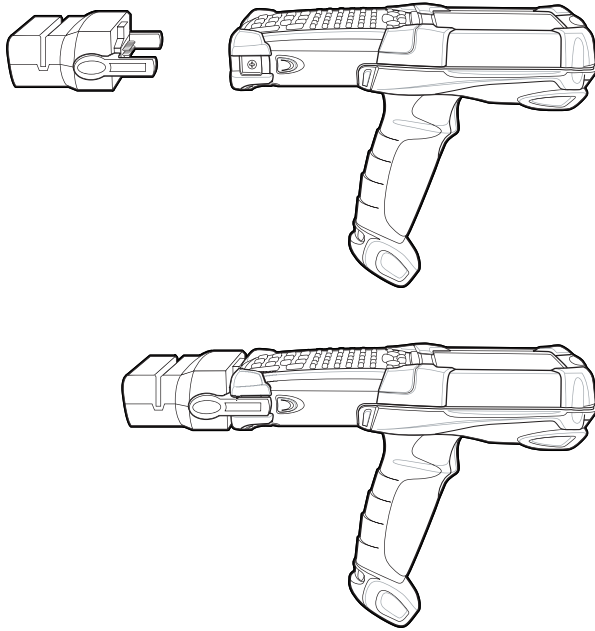

Figure 5-7 Attaching the MSR

To remove, squeeze the latch grips and pull the MSR from the MC9190-G.

✓ **NOTE** Remove the MSR from the bottom of the MC9190-G before using a cradle for charging and communication.

Setup

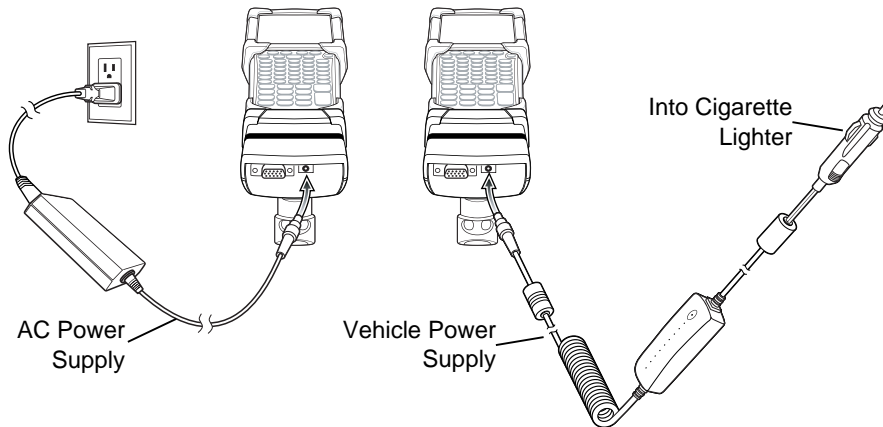

Figure 5-8 MSR Power Connection

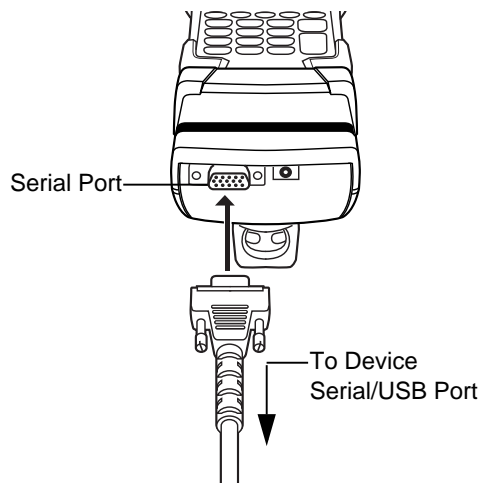

Figure 5-9 MSR Serial/USB Connection

Battery Charging Indicators

To charge the MC9190-G's battery through the MSR, connect the power supply to the MSR (see [Figure 5-8 on page 5-12](#)), then attach the MSR to the MC9190-G. The MC9190-G begins charging automatically.

✓ **NOTE** Batteries must be charged within the 32° to 104° F (0° to +40° C) ambient temperature range.

The MC9190-G's amber charge LED, located in the Indicator LED Bar, shows the status of the battery charging in the MC9190-G. See [Table 1-1 on page 1-4](#) for charging status indications.

The battery usually charges in less than four hours, if the MC9190-G is not in use.

Serial/USB Connection

The MSR can connect to and communicate with a serial/USB device, such as a printer or host computer, through its serial port.

To connect the MSR to a serial/USB device, connect one end of the serial device cable into the serial port on the MSR and the other end into the serial/USB port on the device.

Using the MSR

The *MSR9000* sample application is designed to work with the MSR. This sample application illustrates how an application should handle MSR inputs.

✓ **NOTE** The MSR does not need to be attached to the power supply to read magnetic stripes.

To use the MSR:

1. Attach the MSR to the MC9190-G (see [Attaching and Removing on page 5-11](#)).
2. Power on the MC9190-G.
3. Launch an MSR enabled application.

4. Swipe the magnetic stripe card through the MSR, ensuring the magnetic stripe on the card faces the MC9190-G. The card may be swiped in either direction, from left to right or from right to left. For best results, gently press down on the card while swiping to ensure contact with the bottom of the reader.

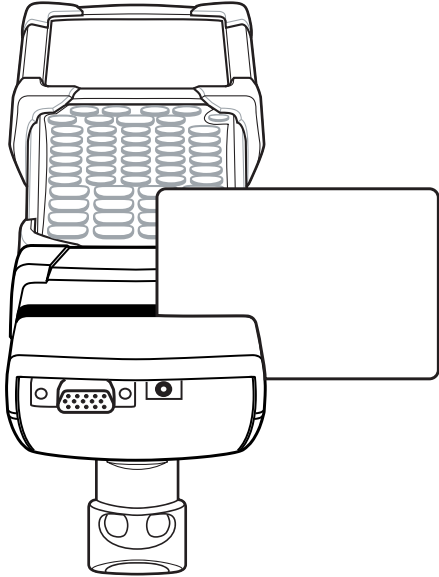

Figure 5-10 *Magnetic Stripe Card Swiping*

Cable Adapter Module

This section describes how to set up and use the snap-on CAM with the MC9190-G. The CAM snaps on to the bottom of the MC9190-G and can be easily removed when not in use.

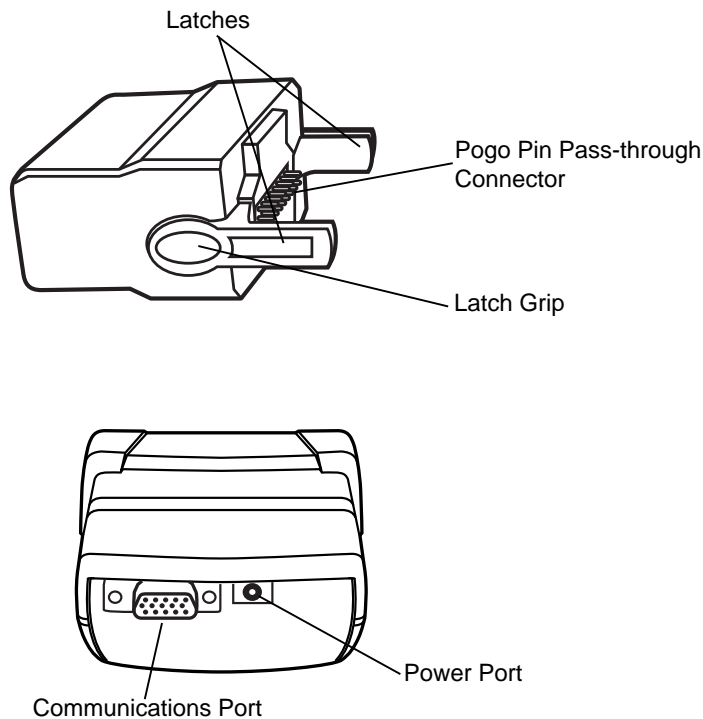

Figure 5-11 Cable Adapter Module

When attached to the MC9190-G, the CAM can perform the following functions.

- Provides power for operating the MC9190-G, with the appropriate power connection.
- ✓ **NOTE** When a MC9190-G with Windows Mobile 6.5 is connected to a host computer through the CAM and an ActiveSync connection is made, the WLAN radio (if applicable) are disabled. This is a Microsoft security feature to prevent connection to two networks at the same time.
- Provides serial connection through the serial pass-through port for communication with a serial device, such as a host computer.
- Provides USB connection through the USB pass-through port for communication with a USB device, such as a host computer.
- Charges the MC9190-G's battery, when used with the appropriate power supply.

Attaching and Removing

To attach, snap the CAM onto the bottom of the MC9190-G.

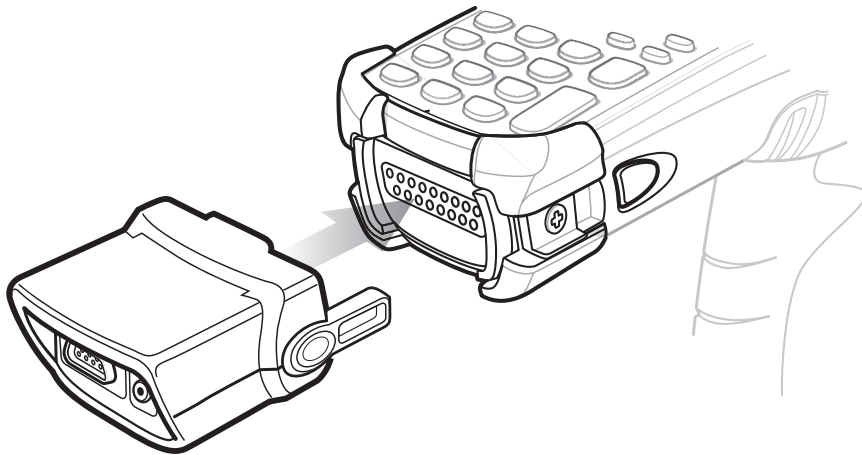

Figure 5-12 Attaching the CAM

To remove, squeeze the latch grips and pull the CAM from the MC9190-G.

✓ **NOTE** Remove the CAM from the bottom of the MC9190-G before using a cradle for charging and communication.

Setup

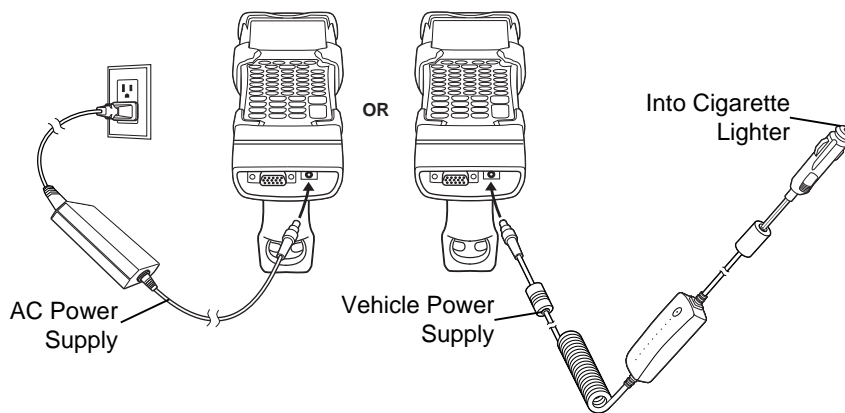

Figure 5-13 CAM Power Connection

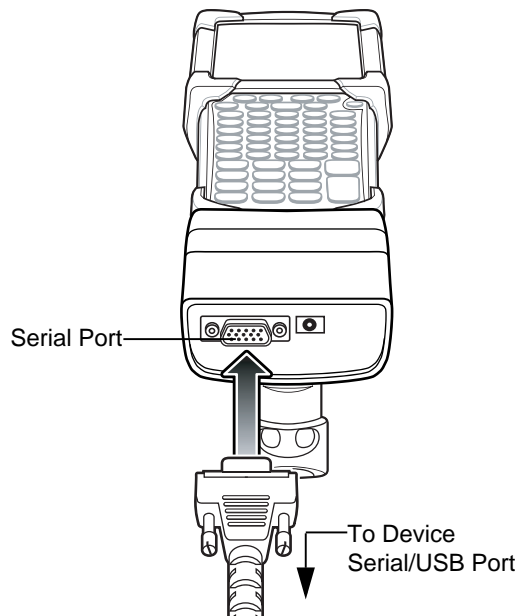

Figure 5-14 CAM Serial Connection

Battery Charging Indicators

To charge the MC9190-G's battery through the CAM, connect the power supply to the CAM (see [Figure 5-13 on page 5-16](#)), then attach the CAM to the MC9190-G. The MC9190-G begins charging automatically.

✓ **NOTE** Batteries must be charged within the 32° to 104° F (0° to +40° C) ambient temperature range.

The MC9190-G's amber charge LED, located in the Indicator LED Bar, shows the status of the battery charging in the MC9190-G. See [Table 1-1 on page 1-4](#) for charging status indications.

The battery usually charges in less than four hours, if the MC9190-G is not in use.

Serial/USB Connection

The CAM can connect to and communicate with a serial/USB device, such as a printer or host computer, through its serial port.

To connect the CAM to a serial/USB device, connect one end of the serial device cable into the serial port on the CAM and the other end into the serial/USB port on the device.

Universal Battery Charger (UBC) Adapter



CAUTION Ensure that you follow the guidelines for battery safety described in [Battery Safety Guidelines on page 6-1](#).

This section describes how to use the UBC adapter to charge a spare battery.

The UBC can be used with a power supply as a standalone spare battery charger or it can be used with the four station UBC2000 to provide charging to simultaneously charge up to four spare batteries. For additional information about the UBC2000, see the [UBC 2000 Universal Battery Charger Product Guide \(p/n 70-33188-xx\)](#).

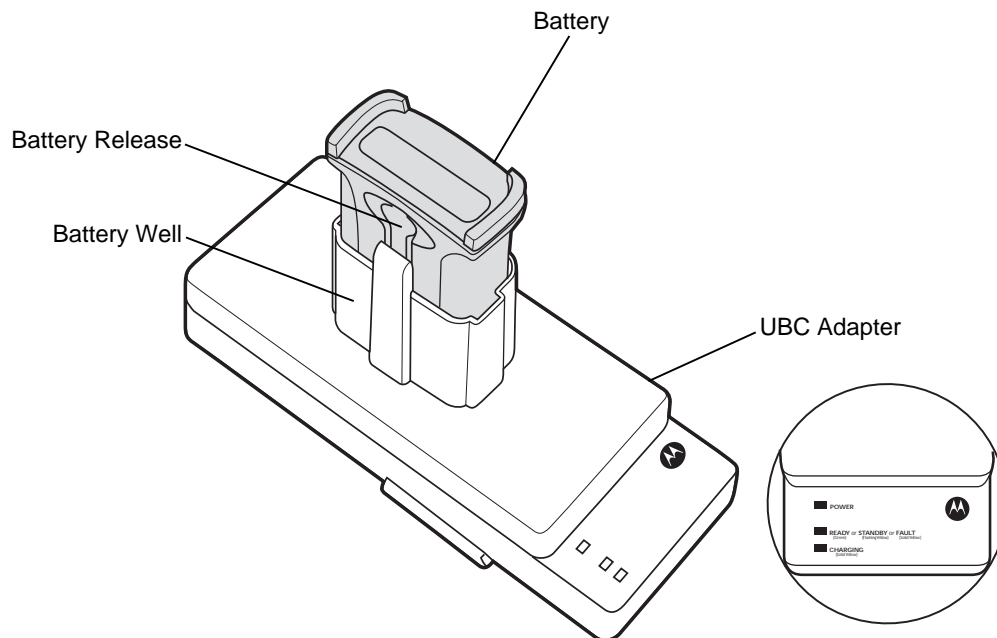

Figure 5-15 UBC Adapter

Inserting and Removing a Battery

Insert the battery into the battery well with the charging contacts facing down (over charging pins) and gently press down on the battery to ensure proper contact.

To remove the battery, press the battery release and lift battery out of the well.

Battery Charging Indicators

To charge a spare battery using the UBC adapter, connect the power supply to the UBC, then insert the spare battery. The spare battery begins charging automatically.

The UBC's charge LEDs (see [Figure 5-16](#)) show the status of the battery charging in the adapter. [Table 5-2](#) shows battery charging status indications.

The battery usually charges in three hours.

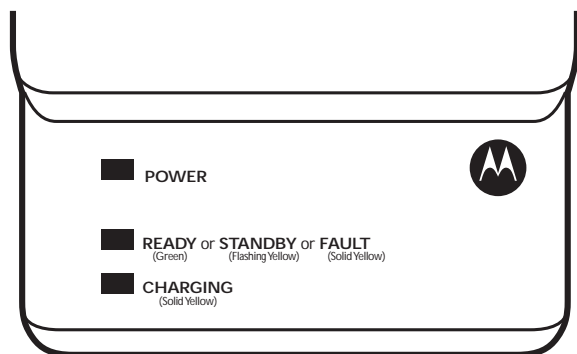

Figure 5-16 UBC Adapter LEDs

Table 5-4 UBC Adapter Charge LED Status Indications

LED	Indication	Description
POWER	Green	Power is connected to the UBC Adapter.
READY or	Green	Charging complete.
STANDBY or	Flashing-Yellow	The battery was deeply discharged and is being trickle charged to bring the voltage up to the operating level. After operating level voltage is achieved the battery charges normally.
FAULT	Yellow	Charging error, check placement of MC9190-G/spare battery.
CHARGING	Yellow	Normal charge.

Modem Dongle

This section describes how to setup and use the MDM9000 Modem Dongle.

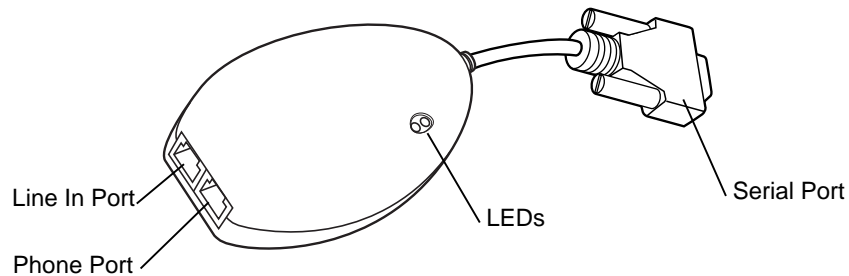

Figure 5-17 *Modem Dongle*

The Modem Dongle enables data communication between the MC9190-G and a host computer, remotely through the phone lines, and synchronizes information between the MC9190-G and a host computer.

The following items are required for a modem connection:

- Telephone number, IP address and DNS/WINS address information from the dial-in server administrator
- Dial-in account on the host system, including a user ID and password
- RJ11 or RJ12 modem cable
- Functioning telephone jack that supports plug-in modems connected to the local telephone system
- Setup of Country Codes to use the modem with the appropriate country's telephone network.

The following items are required for communication:

- MC9190-G
- Cable Adapter Module (CAM), Motorola p/n ADP9000-100 (see [Cable Adapter Module on page 5-15](#))
- Serial Adapter Cable (for communication via cradle), Motorola p/n 25-63856-01
- Microsoft ActiveSync
- Setup of host computer and MC9190-G.

Setup

Connecting to the MC9190-G

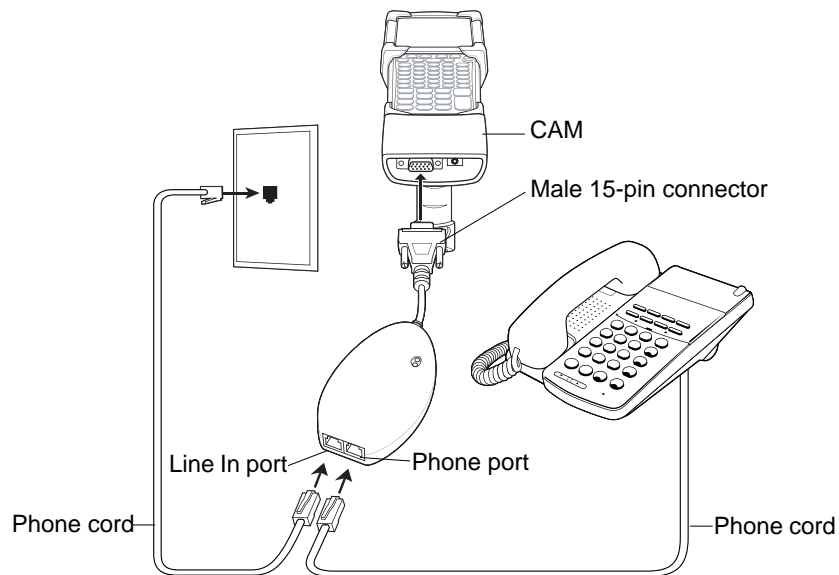

Figure 5-18 Modem Dongle Connection - MC9190-G



CAUTION Do not connect the modem's 15-pin connector into a VGA port of a host computer.

Using the Correct Telephone Line Type

Use a standard analog phone line, as in most households. In an office, use a line connected to a fax machine or modem. In a hotel, request a room with a standard phone line or data port. If necessary, check with the local phone company or administrator to make sure you are using the right type of line before sending data.

Connecting to the Single Slot Serial/USB Cradle

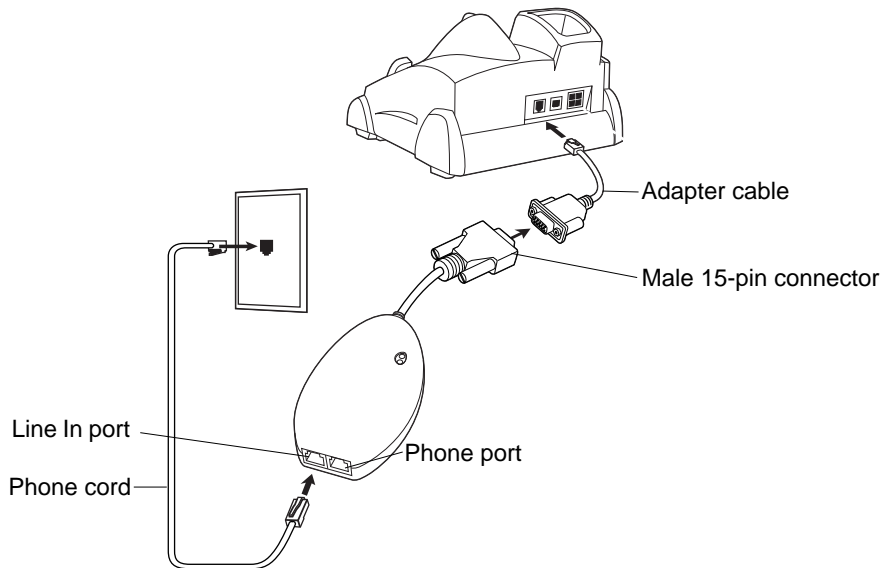

Figure 5-19 Modem Module Connection - Single Slot Serial/USB Cradle



CAUTION Do not connect the modem's 15-pin connector into a VGA port of a host computer.



NOTE If using a phone, connect the cord from the phone to the Phone port on the modem.

Table 5-5 Modem LED Indicator

LED	Indication
Off	Modem is not properly connected to the MC9190-G; modem is not receiving power.
Green	Modem is connected to the MC9190-G and is receiving power.
Solid Amber	MC9190-G is communicating with the host computer.

Forklift Cradle

The Forklift cradle:

- holds a MC9190-G securely in place.
- provides power for operating the MC9190-G.
- provides power for charging a docked MC9190-G.
- provides one serial and one USB port for data communication between a docked MC9190-G and an external device (e.g., a scanner/printer).
- provides power to each port (500mA at 5V). Both ports can be used simultaneously.

When installed without the power converter, the cradle:

- holds a MC9190-G securely in place.
- provides power to the serial port (265mA at 5V) for data communication between a docked MC9190-G and an external device (e.g., a scanner/printer). The USB port is not supported in this mode.

The power converter conditions the fork lift battery power for the fork lift cradle. There is a high-voltage and low-voltage version of the power converter. Make sure that you have ordered the correct converter.

- Low Voltage (Model: 50-14000-252R) — For nominal voltage input of 12V and 24V systems.
- High Voltage (Model: 50-14000-251R) — For nominal voltage input of 36V, 48V, and 60V systems.

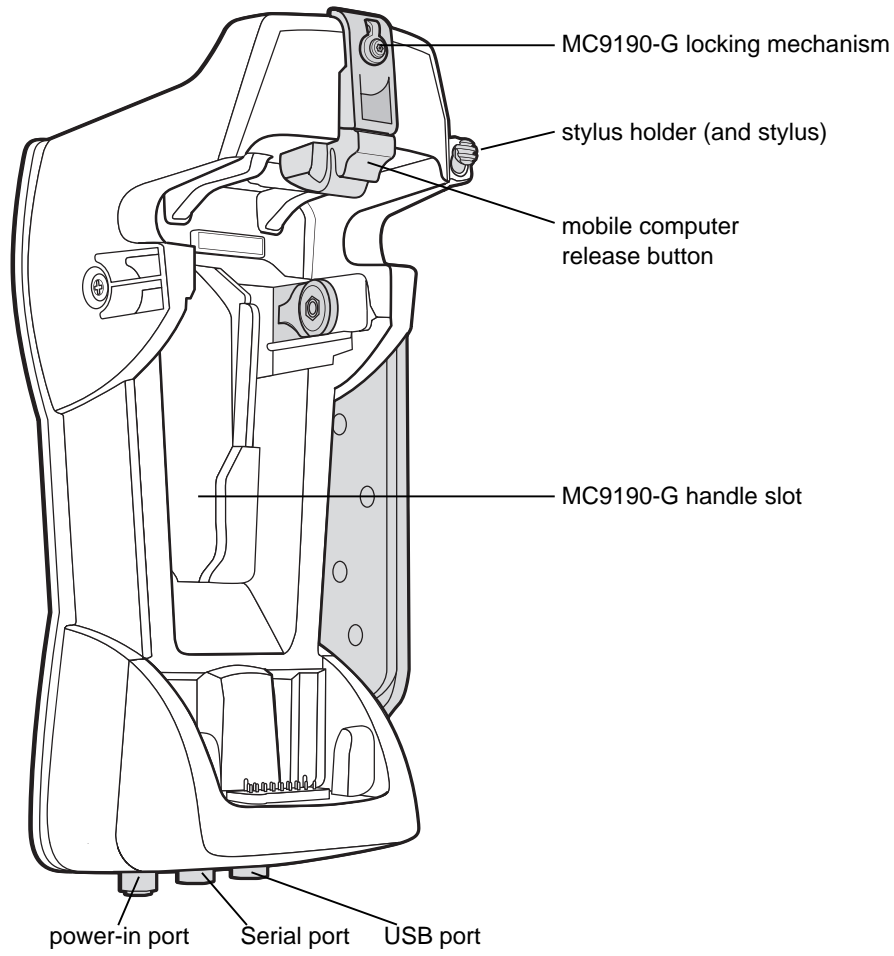

Figure 5-20 *Forklift Cradle*

MC9190-G Insertion and Removal

To insert the MC9190-G into the fork lift cradle, place the bottom of the MC9190-G into the bottom of the fork lift cradle, then press the MC9190-G back into the cradle until the release button locks it in place.



WARNING! Ensure the bottom of the MC9190-G is fully seated into the cup before you push the MC9190-G into the fork lift cradle. Failure to do so may cause property damage.

Ensure the MC9190-G is fully inserted into the fork lift cradle and the release button is holding it securely in place. Pull on the MC9190-G to ensure it is secured properly. Improper insertion can result in property damage or personal injury.

Do not use the product while driving.

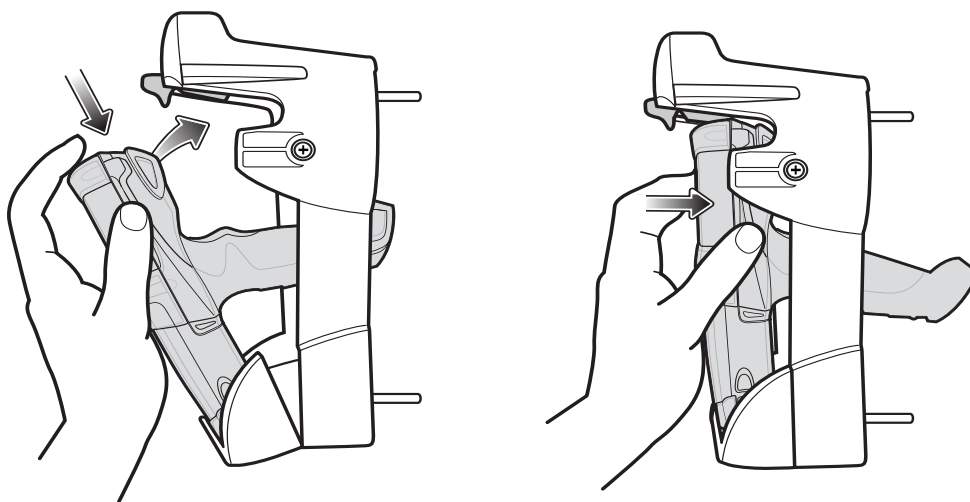

Figure 5-21 Insert MC9190-G into Forklift Cradle

To remove the MC9190-G from the fork lift cradle, lift the release button, then lift the MC9190-G from the cradle. For one handed removal, use the index finger to press the release button up and then remove the MC9190-G with your thumb and other fingers.

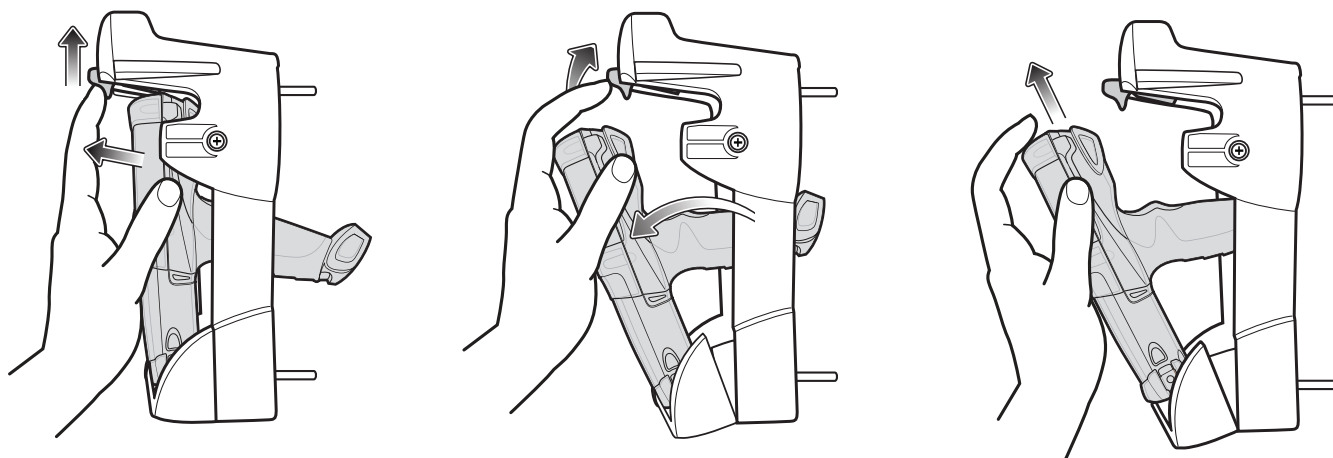

Figure 5-22 Remove MC9190-G from Forklift Cradle

Using the Locking Mechanism

The locking mechanism prohibits the removal of the MC9190-G from the fork lift cradle. To use the locking mechanism, with the MC9190-G in the fork lift cradle, place the locking mechanism into the position behind the release button. Secure it with the attached screw. To remove the locking mechanism, loosen the screw securing it in place.

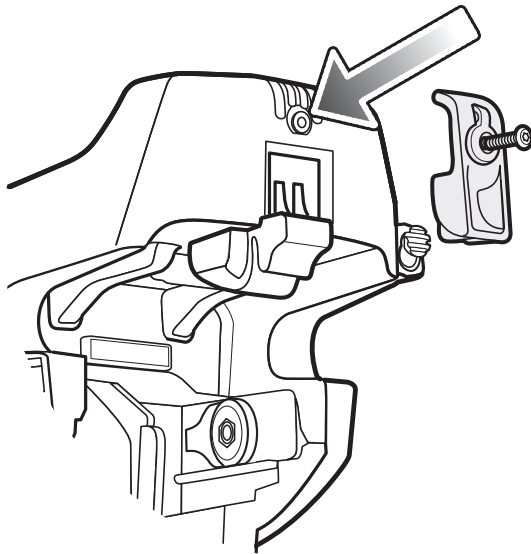

Figure 5-23 Locking Mechanism

Connecting External Devices

The ports on the fork lift cradle are available to enable communication between a docked MC9190-G and external devices such as a scanner and/or a printer.

A serial and/or a USB port are available. Connect one end of the cable (serial or USB cable) to the port on the fork lift cradle, and then connect the other end to the port on the external device. Specific cables are required.

✓ **NOTE** When used with a USB client device, the MC9190-G must be configured as a USB Host.

To place the MC9190-G into Host mode:

1. On Windows Mobile devices, tap **Start > Settings > System > USBConfig** icon. On Windows CE devices, tap **Start > Settings > Control Panel > USBConfig** icon.
2. Tap the **USB Host Mode** radio button.
3. Tap **OK**.

To begin communication:

1. Insert the MC9190-G into the fork lift cradle.
2. Initiate communication on the MC9190-G, as determined by the application used.



CAUTION Removing the MC9190-G during communication disrupts communication between the MC9190-G and the attached device.

Supported Scanners

The forklift cradle supports the following scanners:

- LS3408-FZ20005R (requires USB cable 25-71918-01R or serial cable 25-71917-02R)
- LS3408-ER20005R (requires USB cable 25-71918-01R or serial cable 25-71917-02R)
- LS3478 scanner with FLB3478-C0007WR cradle (requires USB cable 25-71918-01R or serial cable 25-71917-02R)
- LS3578 *Bluetooth*[®] scanner with FLB3508-C007WR cradle (requires USB cable 25-71918-01R or serial cable 25-71917-02R)
- LS3578 *Bluetooth*[®] scanner with FLB3578-C007WR cradle (requires USB cable 25-71918-01R or serial cable 25-71917-02R)
- LS3203 (requires serial cable 25-71916-01R)
- LS42XX (requires USB cable 25-71918-01R or serial cable 25-71917-02R)

Chapter 6 Maintenance & Troubleshooting

Introduction

This chapter includes instructions on cleaning and storing the MC9190-G, and provides troubleshooting solutions for potential problems during MC9190-G operation.

Maintaining the MC9190-G

For trouble-free service, observe the following tips when using the MC9190-G:

- Protect the MC9190-G from temperature extremes. Do not leave it on the dashboard of a car on a hot day, and keep it away from heat sources.
- Do not store or use the MC9190-G in any location that is extremely dusty, damp, or wet.
- Use a soft lens cloth to clean the MC9190-G. If the surface of the MC9190-G screen becomes soiled, clean it with a soft cloth moistened with a diluted window-cleaning solution.
- Periodically replace the rechargeable Li-ion battery to ensure maximum battery life and product performance. Battery life depends on individual usage patterns.
- Take care not to scratch the screen of the MC9190-G. When working with the MC9190-G, use the supplied stylus or plastic-tipped pens intended for use with a touch-sensitive screen. Never use an actual pen or pencil or other sharp object on the surface of the MC9190-G screen.
- The touch-sensitive screen of the MC9190-G contains glass. Take care not to drop the MC9190-G or subject it to strong impact.

Battery Safety Guidelines

- The area in which the units are charged should be clear of debris and combustible materials or chemicals. Particular care should be taken where the device is charged in a non commercial environment.
- Follow battery usage, storage, and charging guidelines found in the user's guide.
- Improper battery use may result in a fire, explosion, or other hazard.

- To charge the mobile device battery, the battery and charger temperatures must be between +32 °F and +104 °F (0 °C and +40 °C)
- Do not use incompatible batteries and chargers. Use of an incompatible battery or charger may present a risk of fire, explosion, leakage, or other hazard. If you have any questions about the compatibility of a battery or a charger, contact Motorola Enterprise Mobility support.
- For devices that utilize a USB port as a charging source, the device shall only be connected to products that bear the USB-IF logo or have completed the USB-IF compliance program.
- Do not disassemble or open, crush, bend or deform, puncture, or shred.
- Severe impact from dropping any battery-operated device on a hard surface could cause the battery to overheat.
- Do not short circuit a battery or allow metallic or conductive objects to contact the battery terminals.
- Do not modify or remanufacture, attempt to insert foreign objects into the battery, immerse or expose to water or other liquids, or expose to fire, explosion, or other hazard.
- Do not leave or store the equipment in or near areas that might get very hot, such as in a parked vehicle or near a radiator or other heat source. Do not place battery into a microwave oven or dryer.
- Battery usage by children should be supervised.
- Please follow local regulations to promptly dispose of used re-chargeable batteries.
- Do not dispose of batteries in fire.
- Seek medical advice immediately if a battery has been swallowed.
- In the event of a battery leak, do not allow the liquid to come in contact with the skin or eyes. If contact has been made, wash the affected area with large amounts of water and seek medical advice.
- If you suspect damage to your equipment or battery, contact Motorola Enterprise Mobility support to arrange for inspection.

Cleaning



CAUTION Always wear eye protection.

Read warning label on compressed air and alcohol product before using.

If you have to use any other solution for medical reasons please contact Motorola for more information.



WARNING! Avoid exposing this product to contact with hot oil or other flammable liquids. If such exposure occurs, unplug the device and clean the product immediately in accordance with these guidelines.

Approved Cleanser Active Ingredients

100% of the active ingredients in any cleaner must consist of one or some combination of the following: isopropyl alcohol, bleach/sodium hypochlorite, hydrogen peroxide or mild dish soap.

Harmful Ingredients

The following chemicals are known to damage the plastics on the MC9190-G and should not come in contact with the device: ammonia solutions, compounds of amines or ammonia; acetone; ketones; ethers; aromatic and chlorinated hydrocarbons; aqueous or alcoholic alkaline solutions; ethanolamine; toluene; trichloroethylene; benzene; carboric acid and TB-lysoform.

Cleaning Instructions

Do not apply liquid directly to the MC9190-G. Dampen a soft cloth or use pre-moistened wipes. Do not wrap the device in the cloth or wipe, but gently wipe the unit. Be careful not to let liquid pool around the display window or other places. Allow the unit to air dry before use.

Special Cleaning Notes

Many vinyl gloves contain phthalate additives, which are often not recommended for medical use and are known to be harmful to the housing of the MC9190-G. The MC9190-G should not be handled while wearing vinyl gloves containing phthalates, or before hands are washed to remove contaminant residue after gloves are removed. If products containing any of the harmful ingredients listed above are used prior to handling the MC9190-G, such as hand sanitizer that contain ethanolamine, hands must be completely dry before handling the MC9190-G to prevent damage to the plastics.

Materials Required

- Alcohol wipes
- Lens tissue
- Cotton tipped applicators
- Isopropyl alcohol
- Can of compressed air with a tube.

Cleaning the MC9190-G

Housing

Using the alcohol wipes, wipe the housing including keys and in-between keys.

Display

The display can be wiped down with the alcohol wipes, but care should be taken not to allow any pooling of liquid around the edges of the display. Immediately dry the display with a soft, non-abrasive cloth to prevent streaking.

Scanner Exit Window

Wipe the scanner exit window periodically with a lens tissue or other material suitable for cleaning optical material such as eyeglasses.

Connector

1. Remove the main battery from the MC9190-G.
2. Dip the cotton portion of the cotton tipped applicator in isopropyl alcohol.

3. Rub the cotton portion of the cotton tipped applicator back-and-forth across the connector on the bottom of the MC9190-G. Do not leave any cotton residue on the connector.
4. Repeat at least three times.
5. Use the cotton tipped applicator dipped in alcohol to remove any grease and dirt near the connector area.
6. Use a dry cotton tipped applicator and repeat steps 4 through 6.
7. Spray compressed air on the connector area by pointing the tube/nozzle about ½ inch away from the surface.



CAUTION Do not point nozzle at yourself and others, ensure the nozzle or tube is away from your face.

8. Inspect the area for any grease or dirt, repeat if required.

Cleaning Cradle Connectors

To clean the connectors on a cradle:

1. Remove the DC power cable from the cradle.
2. Dip the cotton portion of the cotton tipped applicator in isopropyl alcohol.
3. Rub the cotton portion of the cotton tipped applicator along the pins of the connector. Slowly move the applicator back-and-forth from one side of the connector to the other. Do not let any cotton residue on the connector.
4. All sides of the connector should also be rubbed with the cotton tipped applicator.
5. Spray compressed air in the connector area by pointing the tube/nozzle about ½ inch away from the surface.



CAUTION Do not point nozzle at yourself and others, ensure the nozzle or tube is away from your face.

6. Ensure that there is no lint left by the cotton tipped applicator, remove lint if found.
7. If grease and other dirt can be found on other areas of the cradle, use lint free cloth and alcohol to remove.
8. Allow at least 10 to 30 minutes (depending on ambient temperature and humidity) for the alcohol to air dry before applying power to cradle.

If the temperature is low and humidity is high, longer drying time is required. Warm temperature and dry humidity requires less drying time.

Cleaning Frequency

The cleaning frequency is up to the customer's discretion due to the varied environments in which the mobile devices are used. They may be cleaned as frequently as required. However when used in dirty environments it may be advisable to periodically clean the scanner exit window to ensure optimum scanning performance.

Troubleshooting

MC9190-G

Table 6-1 Troubleshooting the MC9190-G

Problem	Cause	Solution
MC9190-G does not turn on.	Lithium-ion battery not charged.	Charge or replace the lithium-ion battery in the MC9190-G.
	Lithium-ion battery not installed properly.	Ensure battery is installed properly. See <i>Installing the Main Battery on page 1-2</i> .
	System crash.	Perform a warm boot. If the MC9190-G still does not turn on, perform a cold boot. See <i>Resetting the MC9190-G on page 2-22</i> .
Rechargeable lithium-ion battery did not charge.	Battery failed.	Replace battery. If the MC9190-G still does not operate, try a warm boot, then a cold boot. See <i>Resetting the MC9190-G on page 2-22</i> .
	MC9190-G removed from cradle while battery was charging.	Insert the MC9190-G in cradle and begin charging. The lithium-ion battery requires less than four hours to recharge fully.
Cannot see characters on display.	MC9190-G not powered on.	Press the Power button.
During data communication, no data was transmitted, or transmitted data was incomplete.	MC9190-G removed from cradle or unplugged from host computer during communication.	Replace the MC9190-G in the cradle, or reattach the Synchronization cable and re-transmit.
	Incorrect cable configuration.	See the System Administrator.
	Communication software was incorrectly installed or configured.	Perform setup. Refer to the <i>MC9190-G Integrator Guide</i> for details. Ensure that Microsoft ActiveSync 4.5 or greater is installed on the host computer.
No sound is audible.	Volume setting is low or turned off.	Adjust volume.

Table 6-1 Troubleshooting the MC9190-G (Continued)

Problem	Cause	Solution
MC9190-G turns itself off.	MC9190-G is inactive.	The MC9190-G turns off after a period of inactivity. If the MC9190-G is running on battery power, this period can be set to 30 sec., 1, 2, 3, 4, 5 or 6 minutes. If the MC9190-G is running on external power, this period can be set to 1, 2, 3, 5, 10, 15 and 30 minutes. For Windows Mobile 6.5 devices, Check the power settings by tapping Start > Settings > System > Power > Advanced . For Windows CE 6.0 devices, Check the power settings by tapping Start > Settings > Control Panel > Power > Advanced . Change the setting if you need a longer delay before the automatic shutoff feature activates.
	Battery is depleted.	Replace the battery.
	Battery is not inserted properly.	Insert the battery properly (see <i>Installing the Main Battery on page 1-2</i>).
Tapping the window buttons or icons does not activate the corresponding feature.	LCD screen not aligned correctly.	Re-calibrate the screen.
	The system is hung.	Warm boot the system. To perform a warm boot (see <i>Resetting the MC9190-G on page 2-22</i>).
A message appears stating that the MC9190-G memory is full.	Too many files stored on the MC9190-G.	Delete unused memos and records. You can save these records on the host computer.
	Too many applications installed on the MC9190-G.	If you have installed additional applications on the MC9190-G, remove them to recover memory. For Windows Mobile 6.5 devices, tap Start > Settings > System > Remove Programs . For Windows CE 6.0 devices, tap Start > Settings > Control Panel > Remove Programs . Select the unused program and tap Remove .

Table 6-1 Troubleshooting the MC9190-G (Continued)

Problem	Cause	Solution
The MC9190-G does not accept scan input.	Scanning application is not loaded.	Verify that the unit is loaded with a scanning application. See the System Administrator.
	Unreadable bar code.	Ensure the symbol is not defaced.
	Distance between exit window and bar code is incorrect.	Ensure MC9190-G is within proper scanning range.
	MC9190-G is not programmed for the bar code.	Ensure the MC9190-G is programmed to accept the type of bar code being scanned.
	MC9190-G is not programmed to generate a beep.	If a beep on a good decode is expected and a beep is not heard, check that the application is set to generate a beep on good decode.
	Battery is low.	If the scanner stops emitting a laser beam when the trigger is pressed, check the battery level. When the battery is low, the scanner shuts off before the MC9190-G low battery condition notification. Note: If the scanner is still not reading symbols, contact the distributor or Motorola.
WLAN connection is lost when the MC9190-G is connected to a host computer using ActiveSync.	Microsoft security feature prevents connection to two separate networks.	Disconnect from the WLAN network prior to connecting to a host computer using ActiveSync.
MC9190-G cannot find any Bluetooth devices nearby.	Too far from other Bluetooth devices.	Move closer to the other Bluetooth device(s), within a range of 10 meters.
	The Bluetooth device(s) nearby are not turned on.	Turn on the Bluetooth device(s) you wish to find.
	The Bluetooth device(s) are not in discoverable mode.	Set the Bluetooth device(s) to discoverable mode. If needed, refer to the device's user documentation for help.
MC9190-G keeps powering down to protect memory contents.	The MC9190-G's battery is low.	Recharge the battery.
There is a delay during a resume from suspend.	This is the normal behavior.	No solution required.

Four Slot Spare Battery Charger

Table 6-2 *Troubleshooting The Four Slot Spare Battery Charger*

Symptom	Possible Cause	Action
Batteries not charging.	Battery was removed from the charger or charger was unplugged from AC power too soon.	Ensure the charger is receiving power. Confirm main battery is charging. If a battery is fully depleted, it can take up to four hours to fully recharge a battery.
	Battery is faulty.	Verify that other batteries charge properly. If so, replace the faulty battery.
	Battery contacts not connected to charger.	Verify that the battery is seated in the battery well correctly with the contacts facing down.

Single Slot Serial/USB Cradle

Table 6-3 *Troubleshooting the Single Slot Serial/USB Cradle*

Symptom	Possible Cause	Solution
LEDs do not light when the MC9190-G or spare battery is inserted.	Cradle is not receiving power.	Ensure the power cable is connected securely to both the cradle and to AC power.
	MC9190-G is not seated firmly in the cradle.	Remove and re-insert the MC9190-G into the cradle, ensuring it is firmly seated.
	Spare battery is not seated firmly in the cradle.	Remove and re-insert the spare battery into the charging slot, ensuring it is firmly seated.
MC9190-G battery is not charging.	MC9190-G was removed from cradle or cradle was unplugged from AC power too soon.	Ensure cradle is receiving power. Ensure the MC9190-G is seated correctly. Confirm main battery is charging. If a MC9190-G battery is fully depleted, it can take up to four hours to fully recharge a battery (if the MC9190-G is off and longer if the MC9190-G is operating). For Windows Mobile 6.5 devices, view battery status by tapping Start > Settings > System > Power . For Windows CE 6.0 devices, view battery status by tapping Start > Settings > Control Panel > Power .
	Battery is faulty.	Verify that other batteries charge properly. If so, replace the faulty battery.
	The MC9190-G is not fully seated in the cradle.	Remove and re-insert the MC9190-G into the cradle, ensuring it is firmly seated.

Table 6-3 Troubleshooting the Single Slot Serial/USB Cradle (Continued)

Symptom	Possible Cause	Solution
Spare battery is not charging.	Battery not fully seated in charging slot.	Remove and re-insert the spare battery into the cradle, ensuring it is firmly seated.
	Battery inserted incorrectly.	Ensure the contacts are facing down and toward the back of the cradle.
	Battery is faulty.	Verify that other batteries charge properly. If so, replace the faulty battery.
During data communications, no data was transmitted, or transmitted data was incomplete.	MC9190-G removed from cradle during communications.	Replace the MC9190-G in cradle and retransmit.
	Incorrect cable configuration.	See the System Administrator.
	Communications software is not installed or configured properly.	Perform setup as described in the <i>MC9190-G Integrator Guide</i> . Ensure that Microsoft ActiveSync 4.5 or greater is installed on the host computer.

Cable Adapter Module

Table 6-4 Troubleshooting The Cable Adapter Module

Symptom	Possible Cause	Solution
MC9190-G battery is not charging.	MC9190-G was removed from CAM or CAM was unplugged from AC power too soon.	Ensure CAM is receiving power. Ensure the MC9190-G is attached correctly. Confirm main battery is charging. If a MC9190-G battery is fully depleted, it can take up to four hours to fully recharge a battery (if the MC9190-G is off and longer if the MC9190-G is operating). For Windows Mobile 6.5 devices, view battery status by tapping Start > Settings > System > Power . For Windows CE 6.0 devices, view battery status by tapping Start > Settings > Control Panel > Power .
	Battery is faulty.	Verify that other batteries charge properly. If so, replace the faulty battery.
	The MC9190-G is not fully attached to the CAM.	Detach and re-attach the CAM to the MC9190-G, ensuring it is firmly connected.

Table 6-4 Troubleshooting The Cable Adapter Module (Continued)

Symptom	Possible Cause	Solution
During data communications, no data was transmitted, or transmitted data was incomplete.	MC9190-G detached from CAM during communications.	Re-attach the MC9190-G to CAM and retransmit.
	Incorrect cable configuration.	See the System Administrator.
	Communications software is not installed or configured properly.	Perform setup as described in the <i>MC9190-G Integrator Guide</i> . Ensure that Microsoft ActiveSync 4.5 or greater is installed on the host computer.

Magnetic Stripe Reader

Table 6-5 Troubleshooting the Magnetic Stripe Reader

Symptom	Possible Cause	Solution
MSR cannot read card.	MC9190-G detached from MSR during card swipe.	Re-attach the MC9190-G to MSR and reswipe the card.
	Faulty magnetic stripe on card.	See the System Administrator.
	MSR application is not installed or configured properly.	Ensure the MSR application is installed on the MC9190-G. Ensure the MSR application is configured correctly.
MC9190-G battery is not charging.	MC9190-G was removed from MSR or MSR was unplugged from AC power too soon.	Ensure MSR is receiving power. Ensure the MC9190-G is attached correctly. Confirm main battery is charging. If a MC9190-G battery is fully depleted, it can take up to four hours to fully recharge a battery (if the MC9190-G is off and longer if the MC9190-G is operating). For Windows Mobile 6.5 devices, view battery status by tapping Start > Settings > System > Power . For Windows CE 6.0 devices, view battery status by tapping Start > Settings > Control Panel > Power .
	Battery is faulty.	Verify that other batteries charge properly. If so, replace the faulty battery.
	The MC9190-G is not fully attached to the MSR.	Detach and re-attach the MSR to the MC9190-G, ensuring it is firmly connected.

Table 6-5 *Troubleshooting the Magnetic Stripe Reader (Continued)*

Symptom	Possible Cause	Solution
During data communications, no data was transmitted, or transmitted data was incomplete.	MC9190-G detached from MSR during communications.	Reattach the MC9190-G to MSR and retransmit.
	Incorrect cable configuration.	See the System Administrator.
	Communications software is not installed or configured properly.	Perform setup as described in the <i>MC9190-G Integrator Guide</i> .

Appendix A Specifications

Technical Specifications

The following tables summarize the MC9190-G's intended operating environment and general technical hardware specifications.

MC9190-G

The following table summarizes the MC9190-G's intended operating environment.

Table A-1 *Technical Specifications*

Item	Description
Physical and Environmental Characteristics	
Dimensions	9.1 in. L x 3.6 in. W x 7.6 in. H 23.1 cm L x 9.1 cm H x 19.3 cm H
Weight	709 g (25 oz.)
Keyboard	28-key; 43-key; 53-key; Terminal Emulation (5250, 3270, VT)
Display	3.7 in. color. Windows Mobile: VGA; Windows CE: QVGA/VGA switchable.
Power	Removable, rechargeable 7.2 V Lithium Ion 2200 mAh battery pack, 15.8 watt hours
Performance Characteristics	
CPU	Marvell PXA320 processor at 806 MHz
Operating System	Microsoft Windows CE 6.0 or Windows Mobile 6.5 Classic
Memory	256 MB RAM/1 GB FLASH
Expansion	SD Card (up to 32 GB)

Table A-1 *Technical Specifications (Continued)*

Item	Description
Application Development	PSDK and EMDK available through Motorola Support Central Web site.
Data Capture Options	SE960: 1D standard range scan engine SE1524-ER: 1D extended range scan engine reads up to 45 ft./13.72 m away SE4600: Extended range omnidirectional 1D/2D imaging engine reads 1D and 2D symbols as close as 8 in./20.32 cm and as far as 30 ft./9.14 m SE4500-SR: Omnidirectional 1D/2D imaging engine reads 1D and 2D symbols SE4500-DL: 1D/2D DL imaging engine reads all 1D and 2D codes as well as the PDF codes found on driver's licenses and other identification documents SE4500-HD: 1D/2D DPM imaging engine reads a wide variety of DPM marks on metal, plastic and glass surfaces, including: dot peening, laser etching, molding, stamping or casting.
User Environment	
Operating Temperature	-4°F to 122°F (-20°C to 50°C)
Storage Temperature	-40°F to 158°F (-40°C to 70°C)
Battery Charging Temperature	32 °F to 104 °F (0 °C to +40 °C)
Humidity	5% to 95% non condensing
Drop Specification	Multiple drops to concrete: 6 ft./1.8 m across the operating temperature range; meets and exceeds MIL-STD 810G
Tumble	2,000 one-meter tumbles at room temperature (4,000 hits) per IEC Tumble Specification
Environmental Sealing	IP64 (electronic enclosure, display and keypad) per IEC Sealing Specification
ESD	+/-15kVdc air discharge +/-8kVdc direct discharge +/-8kVdc indirect discharge

Table A-1 *Technical Specifications (Continued)*

Item	Description
WLAN Wireless Data Communications	
WLAN radio	802.11a/b/g
Output Power	100mW U.S. and International
Data Rate	802.11a: up to 54Mb per second 802.11b: up to 11Mb per second 802.11g: up to 54Mb per second
Frequency Range	All country dependent: 802.11a - 5 GHz; 802.11b – 2.4 GHz; 802.11g – 2.4 GHz
Antenna	Internal
Frequency Range	All country dependent: 802.11a - 5 GHz; 802.11b – 2.4 GHz; 802.11g – 2.4 GHz
WLAN Security	WPA2 Enterprise, 802.1x; EAP-TLS; TTLS (CHAP, MS-CHAP, MS-CHAPv2, PAP or MD5); PEAP (TLS, MSCHAPv2, EAP-GTC); LEAP, EAP-FAST (TLS, MS-CHAPv2, EAP-GTC), WPA2/AES, CCX v4, FIPS 140-2 and IPv6
WPAN Wireless Data Communications	
Bluetooth	Bluetooth Version 2.1 with EDR
Peripherals and Accessories	
Cradles	Single-slot serial/USB, 4-slot Ethernet, 4-slot charge only and forklift
Printers	Supports extensive line of Motorola approved printers
Charger	4-slot battery charger, 4-slot universal battery charger
Other Accessories	Cable Adapter Module; snap-on Magnetic Stripe Reader; Modem module; full set of holsters; full set of cables, Motorola approved CAC Reader for government applications

Table A-2 *Data Capture Options*

Item	Description		
Laser Decode Capability	Code 39 Codabar Interleaved 2 of 5 MSI UPC/EAN supplementals Webcode RSS Expanded	Code 128 Code 11 EAN-8 UPCA Coupon Code RSS-14 Chinese 2 of 5	Code 93 Discrete 2 of 5 EAN-13 UPCE Trioptic 39 RSS Limited
Imaging Decode Capability	Code 39 Codabar Discrete 2 of 5 EAN-13 UPC/EAN supplementals Webcode Composite C Macro PDF-417 RSS Expanded Data Matrix US Planet Canadian 4-state Chinese 2 of 5 microQR	Code 128 Code 11 MSI UPCA Coupon Code TLC39 Micro PDF-417 (Macro) Micro PDF-417 RSS Limited Maxi Code UK 4-state Japanese 4-state USPS 4-state (US4CB)	Code 93 Interleaved 2 of 5 EAN-8 UPCE Trioptic 39 Composite AB PDF-417 QR Code RSS-14 US Postnet Australian 4-state Dutch Kix Aztec

Appendix B Voice Quality Manager

Introduction

The Voice Quality Manager (VQM) is a software package that resides on the MC9190-G. VQM enables a set of features for Voice over WiFi (VoWiFi) calls. The VQM user interface is designed to be intuitive and easy to use, so complex tasks such as enabling the Acoustic Echo Cancellor (AEC) while a call is in progress, automatically switching audio modality for VoWiFi calls, setting appropriate audio gains for VoWiFi, are done with very little or no user intervention.

Features

The VQM software:

- Improves the voice transmission quality without using additional battery power.
- Turns on the AEC for VoWiFi calls automatically, without user intervention.
- Automatically sets correct audio gains for VoWifi calls, via specific profiles for VoWiFi and WAN calls.
- Capability to automatically switch audio mode to handset from speakerphone mode, after initiating a call or after accepting a call.
- Prioritizes the outgoing audio IP packets.
- Provides user-selectable audio modes (speakerphone and handset) with a single tap of the VQM icon. A VQM icon in the title bar of the device indicates the audio mode currently in use.
- NDIS 5.1 compliant.

Enabling VQM

To enable VQM:

1. Tap **Start > Programs > File Explorer**.
2. Navigate to the **Windows** folder.
3. Locate the file **VQMAudioNotify**.

4. Tap the filename to enable VQM.

Audio Modes







The MC75A can be in any one of the seven different audio modes. The mode is visually indicated by the VQM icon on the title bar.



Figure B-1 VQM Icon in Title Bar

The VQM icon indicates that the device is in speakerphone mode without Acoustic Echo Cancellation (indicated by the gray VQM icon). The audio modes and their corresponding VQM title bar icons are:

Table B-1 VQM Icons

	Description
	Speakerphone with Acoustic Echo Cancellation.
	Speakerphone without Acoustic Echo Cancellation.
	Handset with Acoustic Echo Cancellation (device can be transitioned to handset mode only while on a VoWiFi call).
	Headset while on a call (Acoustic Echo Cancellation is not enabled for wired or Bluetooth headsets).
	Headset while not on a call.
	Bluetooth headset while on a call (Acoustic Echo Cancellation is not enabled for wired or Bluetooth headsets). White icon.
	Bluetooth headset while not on a call. Gray icon.

Changing Audio Modes

Depending upon the audio mode being used, the mode can be changed by tapping the VQM icon in the title bar. The audio mode can only be changed while the user is on a call.

The table below lists the current audio mode and the subsequent audio mode after tapping the VQM icon.

Table B-2 *Changing Audio Modes*

	Audio Mode after Tapping VQM Icon
Speakerphone	Handset
Handset	Speakerphone
Wired headset	Wired headset
Bluetooth headset	Reverts back to the last profile used before the Bluetooth connection.

If the audio mode is set to speakerphone and the user taps the VQM icon, the audio mode changes to handset.

When using a Bluetooth headset with BTE Explorer, enable the headset profile and ensure that the device is connectable. Pressing the headset button pairs the headset back to the MC9190-G. A second click of the headset button sends audio to the Bluetooth headset.

If the MC9190-G and the Bluetooth headset are un-paired, there is no way to go back to the Bluetooth headset using the VQM icon. The only way to reconnect the Bluetooth headset to the device is by using the BTE Explorer application.

If the user taps the VQM icon when a wired headset is connected to the MC9190-G, the audio mode does not change. The audio continues to get routed to the wired headset.

If the user taps the VQM icon while not on a call there is not change to the audio mode.

To view the VQM versions numbers tap **Start > File Manager**. Navigate to the **Windows** folder and search for VQMAudioNotify.exe file.

A dialog box displays listing the versions numbers.



Figure B-2 *VQM Audio Control Dialog Box*

Voice Packet Prioritization

IP soft phones transmit voice packets in the same manner as any other application that sends data over the network. On a network with different types of traffic, voice packets are given the same priority as any other traffic, and therefore may be subject to delays.

WiFi Multi-media (WMM) is a solution to this problem. WMM is a specification that supports prioritizing traffic, and “higher-priority” packets can be given preferential treatment.

To make use of WMM, the devices that generate traffic must mark their packets as high or normal priority in a field in the IP packet called Differentiated Services Code-Point (DSCP). The wireless infrastructure, which must be configured to support WMM, gives a higher priority to packets that have been marked as high priority through DSCP marking by the devices that generate traffic.

VQM detects if there is an ongoing Voice over WiFi (VoWiFi) call, and if so, marks outgoing voice packets (Only outgoing voice packets can be marked. The incoming voice packets have already been through the network, so it makes no sense to mark them.) as high-priority using DSCP. This enables WMM-compatible wireless infrastructure to treat the voice packets preferentially. This results in fewer delays for voice packets, which in turn improves the call quality.

Acoustic Echo Cancellation

Acoustic Echo occurs during a voice call when the audio from the earpiece enters the microphone of the same device. This results in the person at the other end hearing back a delayed version of his/her own voice (“Echo”). Needless to say, “Echo” is not desirable, and needs to be suppressed. This is the functionality performed by the Acoustic Echo Canceller (AEC). There are two approaches to suppressing the Echo:

- Turn the Acoustic Echo Canceller (AEC) on permanently. This approach is not very efficient because the device consumes more power when the AEC is on.
- Turn the Acoustic Echo Canceller (AEC) on only when there is an ongoing call.

VQM follows the second of the two approaches mentioned above.

VQM automatically turns on the Acoustic Echo Canceller (AEC) when the mobile device is in a VoWiFi call. When the call is terminated, VQM turns the AEC off. Note that the AEC is turned on for speakerphone and handset modes and does not get turned on for wired headset and Bluetooth headset modes. The AEC is not required for wired headset because the audio volume is quite low (because of the proximity of the earpiece to the ear), and therefore it is very unlikely for the audio from the earpiece to go in to the mouthpiece. Bluetooth headsets typically have an Echo Canceller built in. Turning the AEC on only while on a call saves battery power, compared to leaving the AEC turned on permanently.

The AEC is not turned on for Cellular calls because the WWAN phone application has a built-in echo canceller.

Limitations

- There is no VPN support in VQM.
- Only the Avaya softphone is supported.

Disabling VQM

To disable VQM perform a warm boot.

Appendix C Keypads

Introduction

The MC9190-G has the following interchangeable modular keypads:

- 28-key keypad
- 43-key keypad
- 53-key keypad
- 3270 Emulator
- 5250 Emulator
- VT Emulator.

The modular keypads can be changed in the field, as necessary, to support specialized applications. Refer to the *MC9190-G Integrator Guide* for installation and removal procedures.

28-Key Keypad

The 28-key keypad contains a **Power** button, application keys, scroll keys and function keys. The keypad is color-coded to indicate the alternate function key (blue) values. Note that keypad functions can be changed by an application so the MC9190-G's keypad may not function exactly as described. See [Table C-1 on page C-3](#) for key and button descriptions and [Table C-7 on page C-20](#) for the keypad's special functions.



Figure C-1 28-Key Keypad

Table C-1 28-Key Descriptions









Key	Description
Power (red) 	Turns the MC9190-G on and off. Performs a warm boot and a cold boot. See Resetting the MC9190-G on page 2-22 for information about performing a warm and cold boot.
Green/Red Dot 	To use a key as an application key (APP key) on the keyboard, a new keyboard remap table must be created and installed. However, the Green/Red dot keys can be remapped as APP keys through the registry. Create an XML Provisioning file with the following entries: Characteristic type = "HKEY_LOCAL_MACHINE\HARDWARE\DEVICEMAP\KEYBD" Parm name = "GreenKeyOverride" value = "xx", where xx is the new APP key code. Parm name = "RedKeyOverride" value = "xx", where xx is the new APP key code. Refer to the <i>MC9190-G Integrator Guide</i> for instruction on updating the registry using XML Provisioning. This sends an APP key code, instead of their original key codes, when the green or red dot key is pressed.
Scan (yellow) 	Activates the scanner/imager in a scan enabled application.
Scroll Up and Down 	Moves up and down from one item to another. Increases/decreases specified values.
Scroll Left and Right 	Moves left and right from one item to another. Increases/decreases specified values.
ESC 	Exits the current operation.
One/Star 	Produces the number one in default state. Produces an asterisk in Alpha state.
Alphanumeric 	In default state, produces the numeric value on the key. In Alpha state, produces the lower case alphabetic characters on the key. Each key press produces the next alphabetic character in sequence. For example, press and release the ALPHA key and then press the '4' key once to produce the letter 'g'; press and release the ALPHA key and then press the '4' key three times to produce the letter 'i'. When the SHIFT key is pressed in Alpha state, the upper case alphabetic characters on the key are produced. For example, press and release the ALPHA key, press and release the SHIFT key and then press the '4' key once to produce the letter 'G'; press and release the ALPHA key, press and release the SHIFT key and then press the '4' key three times to produce the letter 'I'.

Table C-1 28-Key Descriptions (Continued)

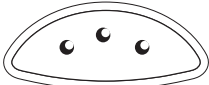











Key	Description
SPACE/BKSP 	Space and backspace functions.
CTRL (Control) 	<p>Press and release the CTRL key to activate the keypad alternate CTRL functions. The LED above the key lights and the  icon appears on the taskbar on WinCE devices or at the bottom of the screen on Windows Mobile 6.5 devices.</p> <p>Press the Blue key followed by the CTRL key to activate the keypad alternate ALT functions. The ALT icon appears on the taskbar on WinCE devices or the  icon appears at the bottom of the screen on Windows Mobile 6.5 devices.</p>
ALPHA 	<p>Press and release the ALPHA key to activate the keypad alternate functions (shown on the keypad in orange). The LED above the key lights when the key is depressed. The  icon appears on the taskbar on WinCE devices and the  icon appears at the bottom of the screen on Windows Mobile 6.5 devices. Press and release the ALPHA key again to return to the normal keypad functions.</p>
Function (blue) 	<p>Press and release the blue function key to activate the keypad alternate functions (shown on the keypad in blue). The LED above the key lights and the  icon appears on the bottom of the screen on Windows Mobile 6.5 devices. Press and release the blue function key again to return to the normal keypad functions.</p>
SHIFT 	<p>Press and release the SHIFT key to activate the keypad alternate SHIFT functions. The  icon appears on the bottom of the screen on Windows Mobile 6.5 devices. Press and release the SHIFT key again to return to the normal keypad functions.</p>
ENT (Enter) 	<p>Executes a selected item or function.</p> <p>For Windows Mobile 6.5: The default behavior of the ENT (Enter) key sends an extra character, which causes a Microsoft Word or Notes application to exit. To make the applications work properly, create an XML Provisioning file with the following entries: Characteristic type = "HKEY_LOCAL_MACHINE\HARDWARE\DEVICEMAP\KEYBD" Para name = "SpecialEnterTabKey" value = 0</p> <p>Refer to the <i>MC9190-G Integrator Guide</i> for instruction on updating the registry using XML Provisioning.</p>
Period/Decimal Point 	<p>In default state, produces a period for alpha entries and a decimal point for numeric entries. In function key state, produces an asterisk. When the SHIFT key is pressed in function key state, produces an asterisk.</p>
Zero 	<p>In default state, produces a zero. In Alpha state, produces a space.</p>
Pound 	<p>Produces a pound/number sign.</p>

Table C-2 43-Key Keypad Descriptions





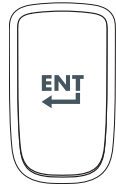
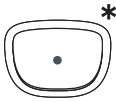



















Key	Description
Power (red) 	Turns the MC9190-G on and off. Performs a warm boot and a cold boot. See Resetting the MC9190-G on page 2-22 for information about performing a warm and cold boot.
Green/Red Dot 	To use a key as an application key (APP key) on the keyboard, a new keyboard remap table must be created and installed. However, the Green/Red dot keys can be remapped as APP keys through the registry. Create an XML Provisioning file with the following entries: Characteristic type = "HKEY_LOCAL_MACHINE\HARDWARE\DEVICEMAP\KEYBD" Parm name = "GreenKeyOverride" value = "xx", where xx is the new APP key code. Parm name = "RedKeyOverride" value = "xx", where xx is the new APP key code. Refer to the <i>MC9190-G Integrator Guide</i> for instruction on updating the registry using XML Provisioning. This sends an APP key code, instead of their original key codes, when the green or red dot key is pressed.
Scan (yellow) 	Activates the scanner/imager in a scan enabled application.
Scroll Up and Down 	Moves up and down from one item to another. Increases/decreases specified values.
Scroll Left and Right 	Moves left and right from one item to another. Increases/decreases specified values.
ESC 	Exits the current operation.
SPACE/BKSP 	Space and backspace functions.
Numeric/Alpha 	Number or alpha value depending on the state of the ALPHA key.
Alpha/Application 	These keys can have an application assigned to the function value and have an alpha value assigned when used with the ALPHA function key. On Windows Mobile 6.5 devices: F6 and F7 keys cannot be remapped and are dedicated by the Operating System to control volume level. When these keys are pressed, Shell.exe traps them and displays the volume adjustment window. To get these keys to an application, call GXOpenInput() at the beginning of the application and call GXClosInput() at the end of the application. This redirects all of the key events to an application, including the F6 and F7 keys. Note: Other applications cannot receive any key event until GXClosInput() is called. For example, if the customer is using the APP1 key to run Calc.exe, this is disabled during this period.
Function (blue) 	Press and release the blue function key to activate the keypad alternate functions (shown on the keypad in blue). The LED above the key lights and the  icon appears at the bottom of the screen. Press and release the blue function key again to return to the normal keypad functions.

Table C-2 43-Key Keypad Descriptions (Continued)

Key	Description
Control 	Press and release the CTRL key to activate the keypad alternate CTRL functions. The LED above the key lights and the  icon appears at the bottom of the screen. Press the Blue key followed by the CTRL key to activate the keypad alternate ALT functions.
ALT 	The ALT icon appears on the taskbar on WinCE devices or the  icon appears at the bottom of the screen on Windows Mobile 6.5 devices.
ALPHA (orange) 	The default keypad mode is the num-lock (number lock) mode. Press the orange ALPHA key to de-activate the num-lock mode and to access the alternate ALPHA characters (shown on the keypad in orange). The LED above the key lights and the  icon appears on the taskbar on WinCE devices or the  icon appears at the bottom of the screen on Windows Mobile 6.5 devices. Press and release the ALPHA key again to return to the normal keypad functions.
Shift 	Changes the state of the alpha characters from lowercase to uppercase. Press the SHIFT key to activate this mode temporarily, followed by another key. The  icon appears at the bottom of the screen. Press the Shift key twice to lock this mode. The  icon appears at the bottom of the screen. Press the Shift key a third time to unlock.
Period/Decimal Point 	Produces a period for alpha entries, a decimal point for numeric entries and the alphabetic character X when the ALPHA function key is activated.
Star 	Produces an asterisk and the alphabetic character Z when the ALPHA function key is activated.
Enter 	Executes a selected item or function. For Windows Mobile 6.5: The default behavior of the ENT (Enter) key sends an extra character, which causes a Microsoft Word or Notes application to exit. To make the applications work properly, create an XML Provisioning file with the following entries: Characteristic type = "HKEY_LOCAL_MACHINE\HARDWARE\DEVICEMAP\KEYBD" Para name = "SpecialEnterTabKey" value = 0 Refer to the <i>MC9190-G Integrator Guide</i> for instruction on updating the registry using XML Provisioning.

53-Key Keypad

There are two physical configurations of the 53-key keypad, however both of the keypads are functionally identical. The 53-key keypad contains a Power button, application keys, scroll keys and function keys. The keypad is color-coded to indicate the alternate function key (blue) values. Note that keypad functions can be changed by an application so the MC9190-G's keypad may not function exactly as described. See [Table C-3 on page C-9](#) for key and button descriptions and [Table C-7 on page C-20](#) for the keypad's special functions.

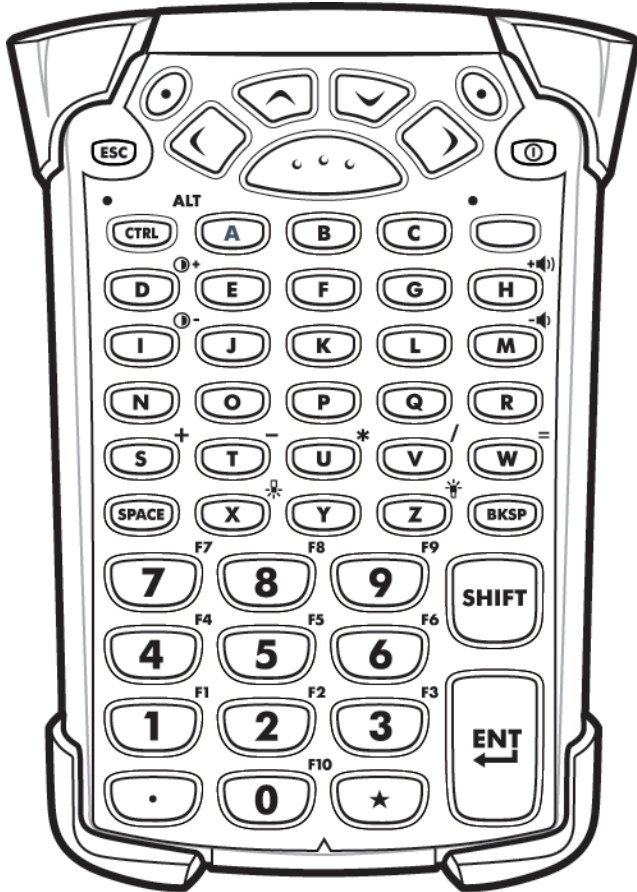

Figure C-3 53-Key Keypad

Table C-3 53-Key Descriptions



















Key	Description
Power (red) 	Turns the MC9190-G on and off. Performs a warm boot and a cold boot. See Resetting the MC9190-G on page 2-22 for information about performing a warm and cold boot.
Green/Red Dot 	To use a key as an application key (APP key) on the keyboard, a new keyboard remap table must be created and installed. However, the Green/Red dot keys can be remapped as APP keys through the registry. Create an XML Provisioning file with the following entries: Characteristic type = "HKEY_LOCAL_MACHINE\HARDWARE\DEVICEMAP\KEYBD" Parm name = "GreenKeyOverride" value = "xx", where xx is the new APP key code. Parm name = "RedKeyOverride" value = "xx", where xx is the new APP key code. Refer to the <i>MC9190-G Integrator Guide</i> for instruction on updating the registry using XML Provisioning. This sends an APP key code, instead of their original key codes, when the green or red dot key is pressed.
Scan (yellow) 	Activates the scanner/imager in a scan enabled application.
Scroll Up and Down 	Moves up and down from one item to another. Increases/decreases specified values.
Scroll Left and Right 	Moves left and right from one item to another. Increases/decreases specified values.
ESC 	Exits the current operation.
Alpha 	Use the alpha keys for alphabetic characters.
SPACE/BKSP 	Space and backspace functions.
Numeric/Application 	Numeric value keys - can have applications assigned with function key(s). For Windows Mobile 6.5 devices: F6 and F7 keys cannot be remapped and are dedicated by the Operating System to control volume level. When these keys are pressed, Shell.exe traps them and displays the volume adjustment window. To get these keys to an application, call GXOpenInput() at the beginning of the application and call GXCloseInput() at the end of the application. This redirects all of the key events to an application, including the F6 and F7 keys. Note: Other applications cannot receive any key event until GXCloseInput() is called. For example, if the customer is using the APP1 key to run Calc.exe, this is disabled during this period.
Function (blue) 	Press and release the blue function key to activate the keypad alternate functions (shown on the keypad in blue). The LED above the key lights and the  icon appears at the bottom of the screen. Press and release the blue function key again to return to the normal keypad functions.

Table C-3 53-Key Descriptions (Continued)

Key	Description
Control 	<p>Press and release the CTRL key to activate the keypad alternate CTRL functions. The LED above the key lights and the CTRL icon appears at the bottom of the screen.</p> <p>Press the Blue key followed by the CTRL key to activate the keypad alternate ALT functions. The ALT icon appears on the bottom of the screen.</p>
Shift 	<p>Changes the state of the alpha characters from lowercase to uppercase. Press the SHIFT key to activate this mode temporarily, followed by another key. The  icon appears at the bottom of the screen. Press the Shift key twice to lock this mode. The  icon appears at the bottom of the screen. Press the Shift key a third time to unlock.</p>
Period/Decimal Point 	<p>Produces a period for alpha entries and a decimal point for numeric entries.</p>
Star 	<p>Produces an asterisk.</p>
Enter 	<p>Executes a selected item or function.</p> <p>For Windows Mobile 6.5 devices: The default behavior of the ENT (Enter) key sends an extra character, which causes a Microsoft Word or Notes application to exit. To make the applications work properly, create an XML Provisioning file with the following entries: Characteristic type = "HKEY_LOCAL_MACHINE\HARDWARE\DEVICEMAP\KEYBD" Para name = "SpecialEnterTabKey" value = 0</p> <p>Refer to the <i>MC9190-G Integrator Guide</i> for instruction on updating the registry using XML Provisioning.</p>

3270 Emulator Keypad

There are two physical configurations of the 3270 emulator keypad, however both of the keypads are functionally identical. The 3270 emulator keypad contains a Power button, application keys, scroll keys and a function key. The keypad is color-coded to indicate the alternate function key (blue) values. Note that keypad functions can be changed by an application so the MC9190-G's keypad may not function exactly as described. See [Table C-4 on page C-12](#) for key and button descriptions and [Table C-7 on page C-20](#) for the keypad's special functions.

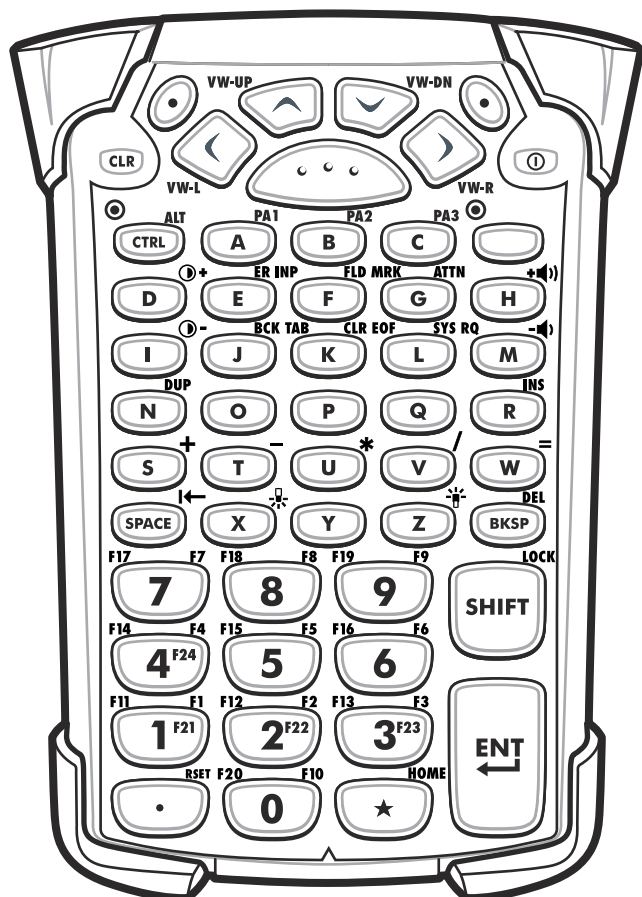

Figure C-4 3270 Emulator Keypad

- ✓ **NOTE** The 3270 emulator keypad is only used when the MC9190-G is running the 3270 emulation software. When the MC9190-G is not running the 3270 emulation software, the 3270 keypad functions are the same as a 53-key keypad.

Table C-4 3270 Emulator Descriptions



















Key	Description
Power (red) 	Turns the MC9190-G on and off. Performs a warm boot and a cold boot. See <i>Resetting the MC9190-G on page 2-22</i> for information about performing a warm and cold boot.
Green/Red Dot 	To use a key as an application key (APP key) on the keyboard, a new keyboard remap table must be created and installed. However, the Green/Red dot keys can be remapped as APP keys through the registry. Create an XML Provisioning file with the following entries: Characteristic type = "HKEY_LOCAL_MACHINE\HARDWARE\DEVICEMAP\KEYBD" Parm name = "GreenKeyOverride" value = "xx", where xx is the new APP key code. Parm name = "RedKeyOverride" value = "xx", where xx is the new APP key code. Refer to the <i>MC9190-G Integrator Guide</i> for instruction on updating the registry using XML Provisioning. This sends an APP key code, instead of their original key codes, when the green or red dot key is pressed.
Scan (yellow) 	Activates the scanner/imager in a scan enabled application.
Scroll Up and Down 	Moves up and down from one item to another. Increases/decreases specified values.
Scroll Left and Right 	Moves left and right from one item to another. Increases/decreases specified values.
CLR 	Exits the current operation.
Alpha 	Use the alpha keys for alphabetic characters.
SPACE/BKSP 	Space and backspace functions.
Application 	These keys can be assigned to an application. On Windows Mobile 6.5 devices: F6 and F7 keys cannot be remapped and are dedicated by the Operating System to control volume level. When these keys are pressed, Shell.exe traps them and displays the volume adjustment window. To get these keys to an application, call GXOpenInput() at the beginning of the application and call GXCloseInput() at the end of the application. This redirects all of the key events to an application, including the F6 and F7 keys. Note: Other applications cannot receive any key event until GXCloseInput() is called. For example, if the customer is using the APP1 key to run Calc.exe, this is disabled during this period.

Table C-4 3270 Emulator Descriptions (Continued)

Key	Description
Function (blue) 	Press and release the blue function key to activate the keypad alternate functions (shown on the keypad in blue). The LED above the key lights and the  icon appears at the bottom of the screen. Press and release the blue function key again to return to the normal keypad functions.
Control 	Press and release the CTRL key to activate the keypad alternate CTRL functions. The LED above the key lights and the  icon appears at the bottom of the screen. Press the Blue key followed by the CTRL key to activate the keypad alternate ALT functions. The ALT icon appears on the bottom of the screen.
Shift 	Press and release the SHIFT key to activate the keypad alternate SHIFT functions. The  icon appears at the bottom of the screen. Press and release the SHIFT key again to return to the normal keypad functions.
Period/Decimal Point 	Produces a period for alpha entries and a decimal point for numeric entries.
Star 	Produces an asterisk.
Enter 	Executes a selected item or function. For Windows Mobile 6.5: The default behavior of the ENT (Enter) key sends an extra character, which causes a Microsoft Word or Notes application to exit. To make the applications work properly, create an XML Provisioning file with the following entries: Characteristic type ="HKEY_LOCAL_MACHINE\HARDWARE\DEVICEMAP\KEYBD" Para name = "SpecialEnterTabKey" value = 0 Refer to the <i>MC9190-G Integrator Guide</i> for instruction on updating the registry using XML Provisioning.

5250 Emulator Keypad

There are two physical configurations of the 5250 emulator keypad, however both of the keypads are functionally identical. The 5250 emulator keypad contains a Power button, application keys, scroll keys and a function key. The keypad is color-coded to indicate the alternate function key (blue) values. Note that keypad functions can be changed by an application so the MC9190-G's keypad may not function exactly as described. See [Table C-5 on page C-15](#) for key and button descriptions and [Table C-7 on page C-20](#) for the keypad's special functions.

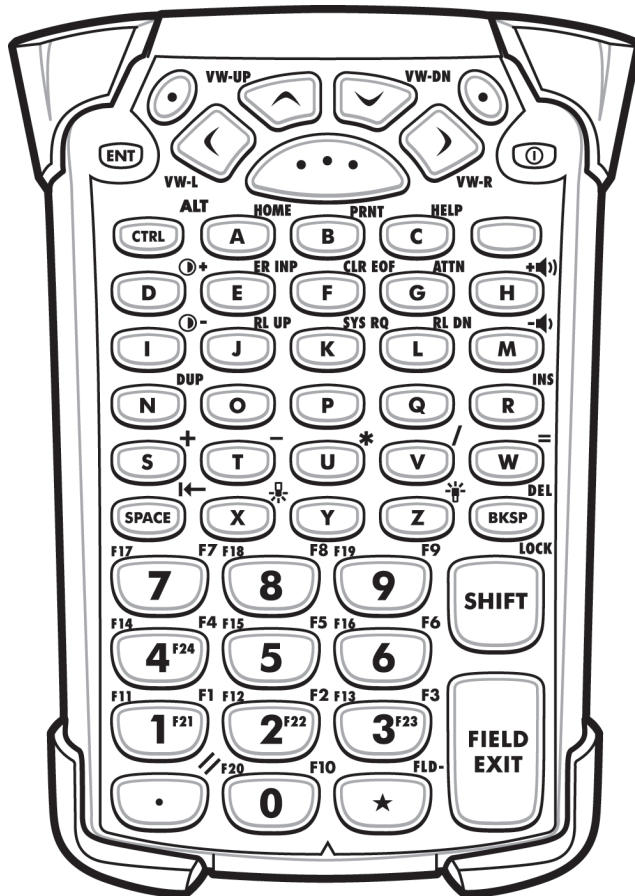

Figure C-5 5250 Emulator Keypad

- ✓ **NOTE** The 5250 emulator configuration is only used when the MC9190-G is running the 5250 emulation software. When the MC9190-G is not running the 5250 emulation software, the 5250 keypad functions are the same as a 53-key keypad.

Table C-5 5250 Emulator Descriptions















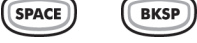

Key	Description
Power (red) 	Turns the MC9190-G on and off. Performs a warm boot and a cold boot. See Resetting the MC9190-G on page 2-22 for information about performing a warm and cold boot.
Green/Red Dot 	To use a key as an application key (APP key) on the keyboard, a new keyboard remap table must be created and installed. However, the Green/Red dot keys can be remapped as APP keys through the registry. Create an XML Provisioning file with the following entries: Characteristic type = "HKEY_LOCAL_MACHINE\HARDWARE\DEVICEMAP\KEYBD" Parm name = "GreenKeyOverride" value = "xx", where xx is the new APP key code. Parm name = "RedKeyOverride" value = "xx", where xx is the new APP key code. Refer to the <i>MC9190-G Integrator Guide</i> for instruction on updating the registry using XML Provisioning. This sends an APP key code, instead of their original key codes, when the green or red dot key is pressed.
Scan (yellow) 	Activates the scanner/imager in a scan enabled application.
Scroll Up and Down 	Moves up and down from one item to another.
Scroll Left and Right 	Moves left and right from one item to another.
ENT 	Exits the current operation.
Alpha 	Use the alpha keys for alphabetic characters.
SPACE/BKSP 	Space and backspace functions.
Application 	These keys can be assigned to an application. On Windows Mobile 6.5 devices: F6 and F7 keys cannot be remapped and are dedicated by the Operating System to control volume level. When these keys are pressed, Shell.exe traps them and displays the volume adjustment window. To get these keys to an application, call GXOpenInput() at the beginning of the application and call GXCloseInput() at the end of the application. This redirects all of the key events to an application, including the F6 and F7 keys. Note: Other applications cannot receive any key event until GXCloseInput() is called. For example, if the customer is using the APP1 key to run Calc.exe, this is disabled during this period.

Table C-5 5250 Emulator Descriptions (Continued)

Key	Description
Function (blue) 	Press and release the blue function key to activate the keypad alternate functions (shown on the keypad in blue). The LED above the key lights and the  icon appears at the bottom of the screen. Press and release the blue function key again to return to the normal keypad functions.
Control 	Press and release the CTRL key to activate the keypad alternate CTRL functions. The LED above the key lights and the  icon appears at the bottom of the screen. Press the Blue key followed by the CTRL key to activate the keypad alternate ALT functions. The ALT icon appears on the bottom of the screen.
Shift 	Press and release the SHIFT key to activate the keypad alternate SHIFT functions. The  icon appears at the bottom of the screen. Press and release the SHIFT key again to return to the normal keypad functions.
Period/Decimal Point 	Produces a period for alpha entries and a decimal point for numeric entries.
Star 	Produces an asterisk.
Enter 	Executes a selected item or function. For Windows Mobile 6.5: The default behavior of the Enter key sends an extra character, which causes a Microsoft Word or Notes application to exit. To make the applications work properly, create an XML Provisioning file with the following entries: Characteristic type = "HKEY_LOCAL_MACHINE\HARDWARE\DEVICEMAP\KEYBD" Para name = "SpecialEnterTabKey" value = 0 Refer to the <i>MC9190-G Integrator Guide</i> for instruction on updating the registry using XML Provisioning.

VT Emulator Keypad

The VT emulator keypad contains a Power button, application keys, scroll keys and a function key. The keypad is color-coded to indicate the alternate function key (blue) values. Note that keypad functions can be changed by an application so the MC9190-G's keypad may not function exactly as described. See [Table C-6 on page C-18](#) for key and button descriptions and [Table C-7 on page C-20](#) for the keypad's special functions.

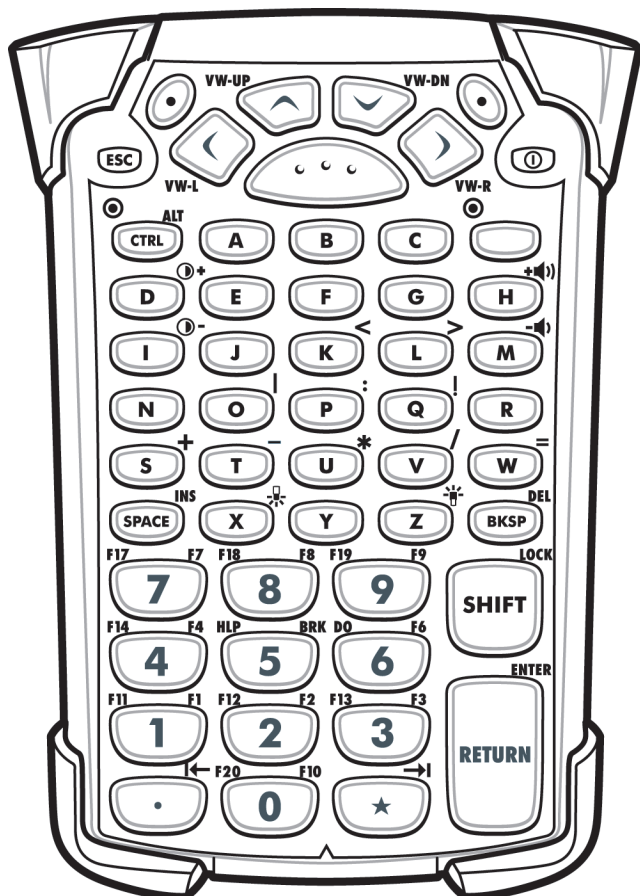

Figure C-6 VT Emulator Keypad

- ✓ **NOTE** The VT emulator configuration is only used when the MC9190-G is running the VT emulation software. When the MC9190-G is not running the VT emulation software, the VT keypad functions are the same as a 53-key keypad.

Table C-6 VT Emulator Descriptions











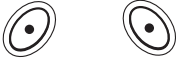



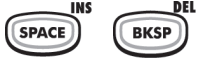

Key	Description
Power (red) 	Turns the MC9190-G on and off. Performs a warm boot and a cold boot. See Resetting the MC9190-G on page 2-22 for information about performing a warm and cold boot.
Green/Red Dot 	To use a key as an application key (APP key) on the keyboard, a new keyboard remap table must be created and installed. However, the Green/Red dot keys can be remapped as APP keys through the registry. Create an XML Provisioning file with the following entries: Characteristic type = "HKEY_LOCAL_MACHINE\HARDWARE\DEVICEMAP\KEYBD" Parm name = "GreenKeyOverride" value = "xx", where xx is the new APP key code. Parm name = "RedKeyOverride" value = "xx", where xx is the new APP key code. Refer to the <i>MC9190-G Integrator Guide</i> for instruction on updating the registry using XML Provisioning. This sends an APP key code, instead of their original key codes, when the green or red dot key is pressed.
Scan (yellow) 	Activates the scanner/imager in a scan enabled application.
Scroll Up and Down 	Moves up and down from one item to another.
Scroll Left and Right 	Moves left and right from one item to another.
ESC 	Exits the current operation.
Alpha 	Use the alpha keys for alphabetic characters.
SPACE/BKSP 	Space and backspace functions.
Application 	These keys can be assigned to an application. F6 and F7 keys cannot be remapped and are dedicated by the Operating System to control volume level. When these keys are pressed, Shell.exe traps them and displays the volume adjustment window. To get these keys to an application, call GXOpenInput() at the beginning of the application and call GXCloseInput() at the end of the application. This redirects all of the key events to an application, including the F6 and F7 keys. Note: Other applications cannot receive any key event until GXCloseInput() is called. For example, if the customer is using the APP1 key to run Calc.exe, this is disabled during this period.









Table C-6 VT Emulator Descriptions (Continued)

Key	Description
Function (blue) 	Press and release the blue function key to activate the keypad alternate functions (shown on the keypad in blue). The LED above the key lights and the  icon appears at the bottom of the screen. Press and release the blue function key again to return to the normal keypad functions.
Control 	Press and release the CTRL key to activate the keypad alternate CTRL functions. The LED above the key lights and the  icon appears at the bottom of the screen. Press the Blue key followed by the CTRL key to activate the keypad alternate ALT functions. The ALT icon appears on the bottom of the screen.
Shift 	Press and release the SHIFT key to activate the keypad alternate SHIFT functions. The  icon appears at the bottom of the screen. Press and release the SHIFT key again to return to the normal keypad functions.
Period/Decimal Point 	Produces a period for alpha entries and decimal point for numeric entries.
Star 	Produces an asterisk.
Enter 	Executes a selected item or function. For Windows Mobile 6.5: The default behavior of the RETURN key sends an extra character, which causes a Microsoft Word or Notes application to exit. To make the applications work properly, create an XML Provisioning file with the following entries: Characteristic type = "HKEY_LOCAL_MACHINE\HARDWARE\DEVICEMAP\KEYBD" Para name = "SpecialEnterTabKey" value = 0 Refer to the <i>MC9190-G Integrator Guide</i> for instruction on updating the registry using XML Provisioning.

Keypad Special Functions

The keypad special functions are color coded on the keypads. For example, on the 53-key keypad, the display backlight icon is blue indicating that the blue function key must be selected first to access the display backlight. On the 43-key keypad, the display backlight icon is white indicating that the display backlight is the default value for that key.

Table C-7 Keypad Special Functions

Icon	28-Key Keypad	43-Key Keypad	53-Key, 3270, 5250, VT Keypad	Special Function
	Blue key + #	 key	Blue key + Z	Turns on and off the display backlight.
	Blue key + 0	 key	Blue key + X	Turns on and off the keypad backlight.
	Blue key + 1	Blue key + F1	Blue key + D	Increases display backlight intensity.
	Blue key + 4	Blue key + F5	Blue key + I	Decreases display backlight intensity.
	Blue key + 3	Blue key + F4	Blue key + H	Increases scan decode beeper volume.
	Blue key + 6	Blue key + F8	Blue key + M	Decreases scan decode beeper volume.
ALT	Blue key + CTRL	Blue key + CTRL	Blue key + CTRL	Enables Alt keypad functions.
	Not available	Not available	Not available	Sends TAB character (forward tab).

✓ **NOTE** Use of display and keypad backlighting can significantly reduce battery life.

Special Characters

The keypads can be selected as necessary to support specialized applications. The keypads contain a **Power** button, application keys, scroll keys and function keys. The keypad is color-coded to indicate the alternate function key (blue) values and the alternate ALPHA key (orange) values. See [Table C-8](#) for the special character generation. Characters can also be generated using the keyboard input panel.

Table C-8 *Special Character Generation Map*

Special Character	28-Key Keypad	43-Key Keypad	53-Key Keypad
[(open square bracket)			Blue Key - E
] (close square bracket)			Blue Key - F
/ (forward slash)	Blue Key - 9	Blue Key - F12	Blue Key - L , Blue Key - V
\ (Backslash)			Blue Key - G
= (equal sign)	Blue Key - 5	Blue Key - BKSP	Blue Key - W
; (semi-colon)			Blue Key - R
` (apostrophe)			Blue Key - J
,			Blue Key - A
.			Blue Key - B
! (exclamation point)			SHIFT - 1
@ (at sign)			SHIFT - 2
# (Pound sign)			SHIFT - 3
\$ (dollar sign)			SHIFT - 4
% (percent sign)			SHIFT - 5
^ (carat)			SHIFT - 6
& (ampersand)			SHIFT - 7
* (asterisk)	Blue Key - . , SHIFT - Blue Key - .		Blue Key - U , SHIFT - Blue Key - U , SHIFT - 8

Table C-8 Special Character Generation Map (Continued)

Special Character	28-Key Keypad	43-Key Keypad	53-Key Keypad
((open parenthesis)			SHIFT - 9
) (close parenthesis)			SHIFT - 0
' (single quote)			Blue Key - C
" (double quote)			SHIFT - Blue Key - C
+ (plus sign)	SHIFT - Blue Key - 5, Blue Key - 7, SHIFT - Blue Key - 7	Blue Key - F9, SHIFT - Blue Key - F9, SHIFT - Blue Key - BKSP	Blue Key - S, SHIFT - Blue Key - S, SHIFT - Blue Key - W
- (dash)	Blue Key - 8	Blue Key - F10, SHIFT - Blue Key - F10	Blue Key - N, Blue Key - T, SHIFT - Blue Key - T
: (colon)			SHIFT - Blue Key - R
< (less than sign)			SHIFT - Blue Key - A
> (greater than sign)			SHIFT - Blue Key - B
? (question mark)	SHIFT - Blue Key - 9	SHIFT - Blue Key - F12	SHIFT - Blue Key - L, SHIFT - Blue Key - V
_ (underscore)	SHIFT - Blue Key - 8		SHIFT - Blue Key - N
{ (open curly bracket)			SHIFT - Blue Key - E
} (close curly bracket)			SHIFT - Blue Key - F
~ (tilde)			SHIFT - Blue Key - J
 (pipe)			SHIFT - Blue Key - G
Tab	Blue Key - Space	Blue Key - Space	Blue Key - Space

Glossary

Numeric

- 802.11.** A group of wireless specifications developed by the Institute of Electrical and Electronics Engineers (IEEE). It specifies an over-the-air interface between a wireless client and a base station or between two wireless clients.
- 802.11a.** Operates in the 5 GHz frequency range (5.125 to 5.85 GHz) with a maximum 54Mbit/sec. signaling rate. The 5 GHz frequency band is not as crowded as the 2.4 GHz frequency because it offers significantly more radio channels than the 802.11b and is used by fewer applications. It has a shorter range than 802.11g and is not compatible with 802.11b.
- 802.11b.** Operates in the 2.4 GHz Industrial, Scientific and Measurement (ISM) band (2.4 to 2.4835 GHz) and provides signaling rates of up to 11Mbit/sec. This is a very commonly used frequency. Microwave ovens, cordless phones, medical and scientific equipment, as well as Bluetooth devices, all work within the 2.4 GHz ISM band.
- 802.11g.** Similar to 802.11b, but this standard supports signaling rates of up to 54Mbit/sec. It also operates in the heavily used 2.4 GHz ISM band but uses a different radio technology to boost overall throughput. Compatible with the 802.11b.

A

- Access Point.** Provides a bridge between Ethernet wired LANs and the wireless network. Access points are the connectivity point between Ethernet wired networks and devices (laptops, hand-held computers, point-of-sale terminals) equipped with a wireless LAN adapter card.
- Ad Hoc Mode.** A wireless network framework in which devices communicate directly with one another without using an access point.
- API.** An interface by means of which one software component communicates with or controls another. Usually used to refer to services provided by one software component to another, usually via software interrupts or function calls
- Application Programming Interface.** See **API**.
- ASCII.** American Standard Code for Information Interchange. A 7 bit-plus-parity code representing 128 letters, numerals, punctuation marks and control characters. It is a standard data transmission code in the U.S.

Association. The process of determining the viability of the wireless connection and establishing a wireless network's root and designated access points. A mobile computer associates with its wireless network as soon as it is powered on or moves into range.

B

Bar Code. A pattern of variable-width bars and spaces which represents numeric or alphanumeric data in machine-readable form. The general format of a bar code symbol consists of a leading margin, start character, data or message character, check character (if any), stop character, and trailing margin. Within this framework, each recognizable symbology uses its own unique format. See **Symbology**.

Bits per Second (bps). Bits transmitted or received.

Bluetooth. A low-cost, short-range radio link between two devices. Bluetooth can replace cables and can be used to create ad hoc networks and provide a standard way to connect devices.

boot or boot-up. The process a computer goes through when it starts. During boot-up, the computer can run self-diagnostic tests and configure hardware and software.

C

CDRH. (Center for Devices and Radiological Health) A federal agency responsible for regulating laser product safety. This agency specifies various laser operation classes based on power output during operation.

CDRH Class 1. This is the lowest power CDRH laser classification. This class is considered intrinsically safe, even if all laser output were directed into the eye's pupil. There are no special operating procedures for this class.

CDRH Class 2. No additional software mechanisms are needed to conform to this limit. Laser operation in this class poses no danger for unintentional direct human exposure.

CHAP. (Challenge Handshake Authentication Protocol) A type of authentication in which the authentication agent (typically a network server) sends the client program a random value that is used only once and an ID value. Both the sender and peer share a predefined secret. The peer concatenates the random value (or nonce), the ID and the secret and calculates a one-way hash using MD5. The hash value is sent to the authenticator, which in turn builds that same string on its side, calculates the MD5 sum itself and compares the result with the value received from the peer. If the values match, the peer is authenticated.

Cold Boot. A cold boot restarts the MC9190-G and erases all user stored records and entries.

COM port. Communication port; ports are identified by number, e.g., COM1, COM2.

Cradle. A cradle is used for charging the terminal battery and for communicating with a host computer, and provides a storage place for the terminal when not in use.

D

DCP. See **Device Configuration Package**.

Decode. To recognize a bar code symbology (e.g., UPC/EAN) and then analyze the content of the specific bar code scanned.

Device Configuration Package. The Motorola Device Configuration Package provides flash partitions, Terminal Configuration Manager (TCM) and the associated TCM scripts. With this package hex images that represent flash partitions can be created and downloaded to the MC9190-G.

E

EAP. (Extensible Authentication Protocol) A general authentication protocol used to control network access. Many specific authentication methods work within this framework.

EAP-PEAP. (Extensible Authentication Protocol-Protected Extensible Authentication Protocol) A mutual authentication method that uses a combination of digital certificates and another system, such as passwords.

EAP-TLS. (Extensible Authentication Protocol-Transport Layer Security) A mutual authentication method that uses digital certificates.

EMDK. Enterprise Mobility Developer's Kit.

Ethernet . An IEEE standard network protocol that specifies how data is placed on and retrieved from a common transmission medium.

ESD. Electro-Static Discharge

F

Flash Memory. Flash memory is nonvolatile, semi-permanent storage that can be electronically erased in the circuit and reprogrammed.

H

Hard Reset. See **Cold Boot**.

Hz. Hertz; A unit of frequency equal to one cycle per second.

Host Computer. A computer that serves other terminals in a network, providing such services as computation, database access, supervisory programs and network control.

I

IEC. International Electrotechnical Commission. This international agency regulates laser safety by specifying various laser operation classes based on power output during operation.

IEC (825) Class 1. This is the lowest power IEC laser classification. Conformity is ensured through a software restriction of 120 seconds of laser operation within any 1000 second window and an automatic laser shutdown if the scanner's oscillating mirror fails.

IEEE Address. See **MAC Address**.

Internet Protocol Address. See **IP**.

IP. (Internet Protocol) The IP part of the TCP/IP communications protocol. IP implements the network layer (layer 3) of the protocol, which contains a network address and is used to route a message to a different network or subnetwork. IP accepts "packets" from the layer 4 transport protocol (TCP or UDP), adds its own header to it and delivers a "datagram" to the layer 2 data link protocol. It may also break the packet into fragments to support the maximum transmission unit (MTU) of the network.

IP Address. (Internet Protocol address) The address of a computer attached to an IP network. Every client and server station must have a unique IP address. A 32-bit address used by a computer on a IP network. Client workstations have either a permanent address or one that is dynamically assigned to them each session. IP addresses are written as four sets of numbers separated by periods; for example, 204.171.64.2.

K

Key. A key is the specific code used by the algorithm to encrypt or decrypt the data. Also see, **Encryption** and **Decrypting**.

L

laser scanner. A type of bar code reader that uses a beam of laser light.

LASER. (Light Amplification by Stimulated Emission of Radiation) The laser is an intense light source. Light from a laser is all the same frequency, unlike the output of an incandescent bulb. Laser light is typically coherent and has a high energy density.

Laser Diode. A gallium-arsenide semiconductor type of laser connected to a power source to generate a laser beam. This laser type is a compact source of coherent light.

LEAP. (Lightweight Extensible Authentication Protocol) A mutual authentication method that uses a username and password system.

LED Indicator. A semiconductor diode (LED - Light Emitting Diode) used as an indicator, often in digital displays. The semiconductor uses applied voltage to produce light of a certain frequency determined by the semiconductor's particular chemical composition.

Liquid Crystal Display (LCD). A display that uses liquid crystal sealed between two glass plates. The crystals are excited by precise electrical charges, causing them to reflect light outside according to their bias. They use little electricity and react relatively quickly. They require external light to reflect their information to the user.

M

Mobile Computer. In this text, mobile computer refers to the Motorola MC9190-G wireless computer. It can be set up to run as a stand-alone device, or it can be set up to communicate with a network, using wireless radio technology.

MS CHAP. (Microsoft Challenge Handshake Authentication Protocol) is the Microsoft version of CHAP and is an extension to RFC 1994. Like the standard version of CHAP, MS-CHAP is used for PPP authentication; in this case, authentication occurs between a PC using Microsoft Windows NT or Microsoft Windows 95 and a Cisco router or access server acting as a network access server (NAS).

N

Nominal. The exact (or ideal) intended value for a specified parameter. Tolerances are specified as positive and negative deviations from this value.

P

PAN . Personal area network. Using Bluetooth wireless technology, PANs enable devices to communicate wirelessly. Generally, a wireless PAN consists of a dynamic group of less than 255 devices that communicate within about a 33-foot range. Only devices within this limited area typically participate in the network.

PING. (Packet Internet Groper) An Internet utility used to determine whether a particular IP address is online. It is used to test and debug a network by sending out a packet and waiting for a response.

Q

QWERTY. A standard keyboard commonly used on North American and some European PC keyboards. "QWERTY" refers to the arrangement of keys on the left side of the third row of keys.

R

RAM. Random Access Memory. Data in RAM can be accessed in random order, and quickly written and read.

ROM. Read-Only Memory. Data stored in ROM cannot be changed or removed.

Router. A device that connects networks and supports the required protocols for packet filtering. Routers are typically used to extend the range of cabling and to organize the topology of a network into subnets. See **Subnet**.

RS-232. An Electronic Industries Association (EIA) standard that defines the connector, connector pins, and signals used to transfer data serially from one device to another.

S

Scanner. An electronic device used to scan bar code symbols and produce a digitized pattern that corresponds to the bars and spaces of the symbol.

Scanning Mode. The scanner is energized, programmed and ready to read a bar code.

Shared Key. Shared Key authentication is an algorithm where both the AP and the MU share an authentication key.

Soft Reset. See **Warm Boot**.

Specular Reflection. The mirror-like direct reflection of light from a surface, which can cause difficulty decoding a bar code.

Subnet. A subset of nodes on a network that are serviced by the same router. See **Router**.

Subnet Mask. A 32-bit number used to separate the network and host sections of an IP address. A custom subnet mask subdivides an IP network into smaller subsections. The mask is a binary pattern that is matched up with the IP address to turn part of the host ID address field into a field for subnets. Default is often 255.255.255.0.

Symbol. A scannable unit that encodes data within the conventions of a certain symbology, usually including start/stop characters, quiet zones, data characters and check characters.

Symbology. The structural rules and conventions for representing data within a particular bar code type (e.g. UPC/EAN, Code 39, PDF417, etc.).

T

TCP/IP. (Transmission Control Protocol/Internet Protocol) A communications protocol used to interconnect dissimilar systems. This standard is the protocol of the Internet and has become the global standard for communications. TCP provides transport functions, which ensures that the total amount of bytes sent is received correctly at the other end. UDP is an alternate transport that does not guarantee delivery. It is widely used for real-time voice and video transmissions where erroneous packets are not retransmitted. IP provides the routing mechanism. TCP/IP is a routable protocol, which means that all messages contain not only the address of the destination station, but the address of a destination network. This allows TCP/IP messages to be sent to multiple networks within an organization or around the world, hence its use in the worldwide Internet. Every client and server in a TCP/IP network requires an IP address, which is either permanently assigned or dynamically assigned at startup.

Terminal Emulation. A "terminal emulation" emulates a character-based mainframe session on a remote non-mainframe terminal, including all display features, commands and function keys. The MC9190 Series supports Terminal Emulations in 3270, 5250 and VT220.

TKIP. (Temporal Key Integrity Protocol) A wireless encryption protocol that periodically changes the encryption key, making it harder to decode.

TLS. (Transport Layer Security) TLS is a protocol that ensures privacy between communicating applications and their users on the Internet. When a server and client communicate, TLS ensures that no third party may eavesdrop or tamper with any message. TLS is the successor to the Secure Sockets Layer (SSL).

V

Visible Laser Diode (VLD). A solid state device which produces visible laser light.

W

Warm Boot. A warm boot restarts the MC9190-G by closing all running programs. All data that is not saved to flash memory is lost.

WAP. (Wireless Application Protocol) A set of specifications, developed by the WAP Forum, that lets developers using Wireless Markup Language build networked applications designed for handheld wireless devices. WAP was designed to work within the constraints of these devices: a limited memory and CPU size, small, monochrome screens, low bandwidth and erratic connections.

WEP. Wired-Equivalent Privacy protocol was specified in the IEEE 802.11 standard to provide a WLAN with a minimal level of security and privacy comparable to a typical wired LAN, using data encryption.

WPA. Wi-Fi Protected Access is a data encryption specification for 802.11 wireless networks that replaces the weaker WEP. It improves on WEP by using dynamic keys, Extensible Authentication Protocol to secure network access, and an encryption method called Temporal Key Integrity Protocol (TKIP) to secure data transmissions.

WPA2. Wi-Fi Protected Access 2 is an enhanced version of WPA. It uses Advanced Encryption Standard instead of TKIP.

WLAN. Wireless local-area networks use radio waves instead of a cable to connect a user device, such as a mobile computer, to a LAN. They provide Ethernet connections over the air and operate under the 802.11 family of specifications developed by the IEEE.

Index

Numerics

28-key keypad	C-2
2-D bar codes	3-2
3270 emulator keypad	C-11
43-key keypad	C-5
5250 emulator keypad	C-14
53-key keypad	C-8

A

AC power	5-13
accessories	
cables	5-3
CAM	5-3, 5-15
installation	5-15
four slot charge only cradle	5-1, 5-9
four slot Ethernet cradle	5-8
four slot Ethernet/USB cradle	5-1
four slot spare battery charger	5-1
holster, quick release	5-3
magnetic stripe reader	5-3
MSR	5-10
battery charging	5-13, 5-18
installation	5-11
magnetic stripe reading	5-13
power connection	5-16
serial connection	5-13, 5-17
serial/USB cradle	5-1
single slot serial/USB cradle	5-6, 5-22
LED indicators	5-7, 5-10
spare battery	5-2
spare battery charger	5-10
UBC	
battery insertion	5-18
Acoustic Echo Cancellation	B-2
ActiveSync	2-11

icon	2-8
adaptive frequency hopping	4-1
AFH	4-1
AirBEAM	2-3, 2-12
aligning screen	1-6
attaching MC9190-G strap	1-6

B

backlight	C-20
backlight intensity	C-20
backup battery	
charging	1-3
bar codes	
two dimensional	3-2
battery	
backup charging	1-3
charging	1-3
removing	1-5
battery charging temperature	A-2
battery icon	2-2, 2-9
battery management	1-7
battery status	2-2
beeper volume	C-20
Bluetooth	4-1
adaptive frequency hopping	4-1
bonding	4-26
deleting bonded device	4-27
security	4-2
turning off	4-5, 4-12
turning on	4-5, 4-12
bluetooth	
communicating icon	2-2
disabled icon	2-2
discovering devices	4-5, 4-10, 4-13
enabled icon	2-2
turning on and off	4-5, 4-12

- bonding
 - Bluetooth 4-26
- boot
 - cold 1-5, 2-19, 2-22, 2-23, 4-3
 - warm 2-19, 2-22, 2-23, 4-4
- bullets xi
- buttons
 - power 2-19

C

- Cable Adapter Module 5-3
- cables 5-3
- calculator 2-11
- calendar 2-11
- calibrating screen 1-6
- CAM 5-3, 5-15
 - installation 5-15
- changing the power settings 1-7
- characters, special C-21
- charging
 - spare batteries 1-4
- charging batteries 1-3
- charging spare batteries 1-4
- cleaning 6-1
- clock & alarms 2-13
- cold boot 1-5, 2-19, 2-22, 2-23, 4-3
- command bar
 - icons 2-8, 2-10
- configuration ix, 1-2
- configurations ix
- Contacts 2-11
- conventions
 - notational xi
- CPU A-1
- cradles
 - four slot charge only 5-1, 5-9
 - four slot Ethernet 5-8
 - four slot Ethernet/USB 5-1
 - serial/USB 5-1
 - single slot 5-6, 5-22
 - LED indicators 5-7, 5-10
 - spare battery charger 5-10
- current time 2-2

D

- data capture ix
 - imager operational modes
 - decode mode 3-3
 - image capture mode 3-3
 - pick list mode 3-3
 - imaging 3-2
 - scanning 3-3

- two dimensional bar codes 3-2
- date/time 2-2
- DCP for MC9190c60 xii
- deleting Bluetooth bond 4-27
- Device Configuration Package for MC9190c60 xii
- dimensions A-1
- display ix, A-1
- display backlight
 - saving power 1-7
- display backlight intensity C-20
- drop specification A-2

E

- electro-static discharge
- ESD 5-5

F

- file explorer 2-11
- four slot charge only 5-1
- four slot charge only cradle 5-9
- four slot Ethernet cradle 5-8
- four slot Ethernet/USB 5-1
- four slot spare battery charger 5-1

G

- getting started 1-2

H

- handset B-2
- hard reset 1-5, 2-19, 2-22, 2-23, 4-3
- headset 2-22
- holster 5-3
- humidity A-2

I

- icons
 - ActiveSync 2-8
 - alpha mode 2-2
 - ALT 2-2
 - battery 2-9
 - bluetooth communicating 2-2
 - bluetooth disabled 2-2
 - bluetooth enabled 2-2
 - CTRL 2-2
 - function 2-2
 - shift 2-2
 - status 2-9
 - task tray 2-8, 2-10
 - wireless status 2-8

imager. See data capture, imaging
 imaging 3-3
 information, service xii
 Internet Explorer Mobile 2-3, 2-11
 internet sharing 2-11
 IrDA 2-13

K

key descriptions
 28-key C-3
 3270 C-12
 43-key C-6
 5250 C-15
 53-key C-9
 special functions C-20
 vt C-18
 keyboard A-1
 keypad backlight
 saving power 1-8
 keypad functions xi
 keypads ix
 28-key C-2
 3270 emulator C-11
 43-key C-5
 5250 emulator C-14
 53-key C-8
 special functions C-20
 types 2-18, C-1
 vt emulator C-17

L

laser scanning 3-1
 LED Indicator Bar 2-17
 lithium-ion battery 1-2

M

magnetic stripe reader 5-3, 5-10
 main battery
 charging 1-2, 1-3
 installing 1-2
 maintenance 6-1
 Media Player 2-11
 memory ix, A-1
 messaging 2-11
 mobile computer
 power on 2-19
 scanning 3-1
 starting 1-5
 mobile computer configuration 1-2
 MSP Agent 2-3, 2-12
 MSR 5-3, 5-10

battery charging 5-13, 5-18
 installation 5-11
 magnetic stripe reading 5-13
 power connection 5-16
 serial connection 5-13, 5-17

N

navigation bar
 icons 2-9
 notes 2-11

O

operating environment, mobile computer A-1
 operating system ix, A-1
 operating temperature A-2

P

parts of the mobile computer 1-1, 5-24
 front view 1-2
 passwords 2-16
 pictures 2-11
 power button 2-19
 power settings 1-7

Q

quick release holster 5-3

R

radios ix
 rapid deployment 2-3, 2-12
 related documents xii
 related software xii
 removing main battery 1-5
 reset
 hard 1-5, 2-19, 2-22, 2-23, 4-3
 soft 2-19, 2-22, 2-23, 4-4
 resetting 2-22
 resume 4-4

S

scan LED indicators 3-1
 scan status 3-1
 scanning
 angle 3-2
 imaging 3-2
 indicator 3-1
 LED indicators 3-1
 range 3-2

scanning considerations	3-2
screen	
calibration	1-6
security	
Bluetooth	4-2
serial/USB cradle	5-1
settings	
about	2-13
beam	2-13
buttons	2-13
certificates	2-13
connections	2-13
customer feedback	2-14
encryption	2-14
error reporting	2-14
keylight	2-14
lock	2-13
memory	2-14
owner information	2-13
power	2-14
regional settings	2-14
remove programs	2-14
screen	2-14
sounds & notifications	2-13
system info	2-14
USB to PC	2-13
Wi-Fi	2-13
wireless manager	2-13
single slot serial/USB cradle	5-6, 5-22
LED indicators	5-7, 5-10
soft reset	2-19, 2-22, 2-23, 4-4
spare batteries	
charging	1-4
spare battery	5-2
charging	1-4
spare battery charger	5-10
special characters	C-21
specifications	A-1
starting the mobile computer	1-2, 1-5
status	2-1
status icon	2-1, 2-2, 2-9
battery	2-9
status icons	
Windows CE 6.0	2-1
storage temperature	A-2
strap	1-2, 1-6
attaching to the MC9190-G	1-6
stylus	1-2
suspend	2-19, 4-4
synchronize with PC	
using Bluetooth	4-8

T

task tray icons	2-8
taskbar	2-1
tasks	2-11
technical specifications, mobile computer	A-1
terminal	
charging	2-2
terminal charging	2-2
troubleshooting	6-5
cable adapter module	6-9
four slot spare battery charger	6-8
magnetic stripe reader	6-10
mobile computer	6-5
single slot serial/USB cradle	6-8
turning the radios off	
WLAN	1-8

U

UBC	5-18
universal battery charger	5-18
unpacking	1-2
using headset	2-22

V

videos	2-11
Voice Quality Manager	B-1
volume	C-20
VQM	B-1
disabling	B-4
enabling	B-1
vt emulator keypad	C-17

W

wakeup conditions	2-24
warm boot	2-19, 2-22, 2-23, 4-4
weight	A-1
Windows Live	2-11
Windows Live Messenger	2-11
Wireless	1-8
Wireless Manager	1-8
wireless manager	2-13
wireless status	2-8
wireless status icon	2-2
WLAN 802.11 a/b/g	ix
WLAN status	2-2
WPAN Bluetooth	ix



MOTOROLA

Motorola Solutions, Inc.
One Motorola Plaza
Holtsville, New York 11742, USA
1-800-927-9626
<http://www.motorola.com>

MOTOROLA, MOTO, MOTOROLA SOLUTIONS and the Stylized M Logo are trademarks or registered trademarks of Motorola Trademark Holdings, LLC and are used under license. All other trademarks are the property of their respective owners.

© 2011 by Motorola Solutions, Inc. All rights reserved.