



MC9500-K Mobile Computer

User Guide



***MC9500-K Mobile Computer
User Guide***

72E-118501-01

Rev. A

September 2009

© 2009 by Motorola, Inc. All rights reserved.

No part of this publication may be reproduced or used in any form, or by any electrical or mechanical means, without permission in writing from Motorola. This includes electronic or mechanical means, such as photocopying, recording, or information storage and retrieval systems. The material in this manual is subject to change without notice.

The software is provided strictly on an “as is” basis. All software, including firmware, furnished to the user is on a licensed basis. Motorola grants to the user a non-transferable and non-exclusive license to use each software or firmware program delivered hereunder (licensed program). Except as noted below, such license may not be assigned, sublicensed, or otherwise transferred by the user without prior written consent of Motorola. No right to copy a licensed program in whole or in part is granted, except as permitted under copyright law. The user shall not modify, merge, or incorporate any form or portion of a licensed program with other program material, create a derivative work from a licensed program, or use a licensed program in a network without written permission from Motorola. The user agrees to maintain Motorola’s copyright notice on the licensed programs delivered hereunder, and to include the same on any authorized copies it makes, in whole or in part. The user agrees not to decompile, disassemble, decode, or reverse engineer any licensed program delivered to the user or any portion thereof.

Motorola reserves the right to make changes to any software or product to improve reliability, function, or design.

Motorola does not assume any product liability arising out of, or in connection with, the application or use of any product, circuit, or application described herein.

No license is granted, either expressly or by implication, estoppel, or otherwise under any Motorola, Inc., intellectual property rights. An implied license only exists for equipment, circuits, and subsystems contained in Motorola products.

MOTOROLA and the Stylized M Logo and Symbol and the Symbol logo are registered in the US Patent & Trademark Office. Bluetooth is a registered trademark of Bluetooth SIG. Microsoft, Windows and ActiveSync are either registered trademarks or trademarks of Microsoft Corporation. All other product or service names are the property of their respective owners.

Motorola, Inc.
One Motorola Plaza
Holtsville, New York 11742-1300
<http://www.motorola.com/enterprisemobility>

Patents

This product is covered by one or more of the patents listed on the website: www.motorola.com/enterprisemobility/patents.

Table of Contents

Patents.....	ii
Revision History.....	iii

About This Guide

Introduction.....	xiii
Documentation Set.....	xiii
Configurations.....	xiv
Keypads.....	xiv
Software Versions.....	xiv
Chapter Descriptions.....	xvii
Notational Conventions.....	xvii
Related Documents.....	xviii
Service Information.....	xviii

Chapter 1: Getting Started

Introduction.....	1-1
Unpacking.....	1-1
Part of the MC9500-K.....	1-2
Getting Started.....	1-3
Installing a microSD Card.....	1-3
Installing the SIM Card.....	1-4
Installing the Battery.....	1-6
Charging the Battery.....	1-6
Charging Temperature.....	1-7
Powering On the MC9500-K.....	1-8
Calibrating the Screen.....	1-8
Replacing the Battery.....	1-8
Removing the microSD Card.....	1-9
Removing the SIM Card.....	1-9

Chapter 2: Battery Management

Introduction.....	2-1
-------------------	-----

Battery Functionality	2-1
Battery Health	2-2
Battery Status	2-3
Installed in an MC9500-K	2-3
In a Charger	2-5
Stand-alone	2-8
Charging the MC9500-K	2-9
Charging a Spare Battery	2-11
Charging Temperature	2-12
Power Saving Techniques	2-13
Changing the Power Settings	2-13
Changing the Backlight Settings	2-13
Changing the Keypad Backlight Settings	2-13
Turning Off the Radios	2-13

Chapter 3: Using the MC9500-K

Introduction	3-1
LED Indicators	3-1
Resetting the MC9500-K	3-3
Performing a Warm Boot	3-3
Performing a Cold Boot	3-3
Waking the MC9500-K	3-3
Locking the MC9500-K	3-4
Keypad Locking	3-4
Password Locking	3-5
Keypads	3-6
Function Buttons	3-7
Stylus	3-7
Entering Data	3-8
Interactive Sensor Technology	3-9
Power Management	3-9
Display Orientation	3-9
Free Fall Detection	3-10
Today Screen	3-11
Status Icons	3-11
Programs	3-14
Settings	3-17
Adjusting Volume	3-20
Battery Status Indications	3-20
Battery Reserve Options	3-21
Main Battery Temperature Notifications	3-22
Using Voice-Over-IP	3-23
Infrared Connection	3-24
Exchanging Files using IR Connection	3-24
Printing	3-25

Chapter 4: Data Capture

Introduction	4-1
--------------------	-----

Laser Scanning	4-1
Scanning Considerations	4-1
Laser Scanning	4-2
Decode Zones	4-3
Imaging	4-5
Operational Modes	4-6
Imager Scanning	4-6
Imager Decode Ranges	4-8
Color Digital Camera	4-9
Digital Camera Scanning	4-9
Taking Photos	4-10
Recording Video	4-10
Viewing Photos and Videos	4-11

Chapter 5: Using the Phone

Introduction	5-1
Accessing the Phone Keypad	5-1
Turning the Phone On and Off	5-2
Audio Modes	5-3
Using a Wired Headset	5-3
Using a Bluetooth Headset	5-4
Adjusting Audio Volume	5-5
Hearing Aid Compatibility Setting	5-5
Making a Call	5-6
Using the Phone	5-6
Using Contacts	5-6
Creating an Outlook Contact	5-7
Editing an Outlook Contact	5-7
Deleting a Contact	5-8
Creating a SIM Contact	5-8
Using Call History	5-8
Making a Speed Dial Call	5-9
Making an Emergency Call	5-9
Answering a Call	5-10
Incoming Call Features	5-10
Smart Dialing	5-11
Muting a Call	5-12
Taking Notes	5-12
Using Speed Dial	5-13
Adding a Speed Dial Entry	5-13
Editing a Speed Dial Entry	5-15
Deleting a Speed Dial Entry	5-16
Using Call History	5-16
Managing Call History	5-16
Changing the Call History View	5-17
Resetting the Recent Calls Counter	5-17
Deleting Call History Items by Call Date	5-18
Deleting All Call History Items	5-18
Viewing Call Status	5-18

Using the Call History Menu	5-19
Swapping Calls on an MC9596	5-20
Swapping Calls on an MC9598	5-20
Conference Calling on an MC9596	5-21
Three-way Calling on an MC9598	5-23
Text Messaging	5-24
Viewing Text Messages	5-24
Sending a Text Message	5-26
Establishing a MC9596 Data Connection	5-28
Ending a Data Connection	5-29
Establishing an MC9598 Data Connection	5-30
Ending a Data Connection	5-30

Chapter 6: Using GPS Navigation

Introduction	6-1
Software Installation	6-1
MC9500-K GPS Setup	6-1
Operation	6-2
GPS Maps on microSD Cards	6-2
Answering a Phone Call While Using GPS	6-2
Losing the GPS Signal While in a Vehicle	6-2
Assisted GPS	6-2

Chapter 7: Using Bluetooth

Introduction	7-1
Adaptive Frequency Hopping	7-1
Security	7-2
Bluetooth Configuration	7-3
Bluetooth Power States	7-4
Cold Boot	7-4
Warm Boot	7-4
Suspend	7-4
Resume	7-5
Using Microsoft Bluetooth Stack	7-5
Turning the Bluetooth Radio Mode On and Off	7-5
Enabling Bluetooth	7-5
Disabling Bluetooth	7-5
Discovering Bluetooth Device(s)	7-6
Available Services	7-8
Object Push Services via Beam	7-9
Internet Sharing	7-10
Hands-free Services	7-11
Serial Port Services	7-12
ActiveSync Using Serial Port Services	7-13
Phone Book Access Profile Services	7-14
Dial-Up Networking Services	7-15
Connect to a HID Device	7-15
A2DP/AVRCP Services	7-15

Using StoneStreet One Bluetooth Stack	7-17
Turning the Bluetooth Radio Mode On and Off	7-17
Disabling Bluetooth	7-17
Enabling Bluetooth	7-17
Modes	7-17
Wizard Mode	7-17
Explorer Mode	7-18
Discovering Bluetooth Device(s)	7-18
Available Services	7-21
File Transfer Services	7-22
Connecting to the Internet Using an Access Point	7-24
Dial-Up Networking Services	7-24
Object Exchange Push Services	7-25
Headset Services	7-29
Hands-free Services	7-30
Serial Port Services	7-30
ActiveSync Using Serial Port Services	7-31
Personal Area Network Services	7-32
IrMC Synchronization Services	7-32
A2DP/AVRCP Services	7-32
Connect to a HID Device	7-33
Bonding with Discovered Device(s)	7-34
Bluetooth Settings	7-36
Device Info Tab	7-36
Services Tab	7-37
Security Tab	7-44
Discovery Tab	7-45
Virtual COM Port Tab	7-45
HID Tab	7-46
Profiles Tab	7-47
System Parameters Tab	7-48
Miscellaneous Tab	7-48

Chapter 8: Accessories

Introduction	8-1
Universal Accessory System	8-3
Single Bay USB Cradle	8-4
Communication and Charging the MC9500-K Battery	8-4
Single Slot Battery Charger	8-6
Charging the Battery	8-6
Four Bay Charge Only Cradle	8-7
Charging	8-7
Four Bay Ethernet Cradle	8-9
Communication and Charging	8-9
LED Indicators	8-10
Speed LED	8-10
Link LED	8-10
Four Slot Battery Charger	8-11
Battery Charging	8-11

Vehicle Cradle	8-12
Charging the MC9500-K Battery	8-12
Vehicle Battery Charger	8-13
Charging the Battery	8-13
Magnetic Stripe Reader	8-14
Attaching and Removing the MSR	8-14
Using the MSR	8-14
Cables	8-16
Battery Charging and Operating Power	8-17

Chapter 9: Maintenance & Troubleshooting

Introduction	9-1
Maintaining the MC9500-K	9-1
Removing the Screen Protector	9-2
Battery Safety Guidelines	9-2
Cleaning	9-3
Materials Required	9-3
Cleaning the MC9500-K	9-4
Housing	9-4
Display	9-4
Scanner Exit Window	9-4
Interface Connector	9-4
Battery Contacts	9-4
Cleaning Cradle Connectors	9-5
Cleaning Frequency	9-5
Troubleshooting	9-6
MC9500-K	9-6
Bluetooth Connection	9-8
Single Bay USB Cradle	9-9
Single Slot Battery Charger	9-10
Four Bay Ethernet Cradle	9-10
Four Bay Charge Only Cradle	9-11
Vehicle Cradle	9-12
Four Slot Battery Charger	9-13
Cables	9-13
Magnetic Stripe Reader	9-14

Appendix A: Technical Specifications

MC9500-K Technical Specifications	A-1
MC9500-K	A-1
MC9500-K Accessory Specifications	A-7
Single Bay USB Cradle	A-7
Single Slot Battery Charger	A-7
Four Bay Ethernet Cradle	A-8
Four Bay Charge Only Cradle	A-9
Four Slot Battery Charger	A-9
Magnetic Stripe Reader	A-10
Vehicle Cradle	A-11

Vehicle Battery Charger	A-11
-------------------------------	------

Appendix B: Voice Quality Manager

Introduction	B-1
Features	B-1
Enabling VQM	B-1
Audio Modes	B-2
Changing Audio Modes	B-2
Voice Packet Prioritization	B-3
Limitations	B-4
Acoustic Echo Cancellation	B-4
Disabling VQM	B-4

Appendix C: Keypads

Introduction	C-1
Alpha Primary Keypad	C-2
Alpha Numeric Keypad	C-6
Calculator Numeric Keypad	C-10
Telephony Numeric Keypad	C-14
Special Character Key	C-18

Glossary

Index

About This Guide

Introduction

This guide provides information about using the MC9500-K mobile computers and accessories.

✓ **NOTE** Screens and windows pictured in this guide are samples and can differ from actual screens.

Documentation Set

The documentation set for the MC9500-K provides information for specific user needs, and includes:

- **MC9500-K Quick Start Guide** - describes how to get the MC9500-K mobile computer up and running.
- **MC9500-K Mobile Computer User Guide** - describes how to use the MC9500-K mobile computer.
- **MC9500-K Mobile Computer Integrator Guide** - describes how to set up the MC9500-K mobile computer and accessories.
- **Microsoft® Applications for Windows Mobile® 6 User Guide** - describes how to use Microsoft developed applications.
- **Enterprise Mobility Application Guide** - describes how to use Enterprise Mobility developed sample applications.
- **Enterprise Mobility Developer Kit (EMDK) Help File** - provides API information for writing applications.

Configurations

This guide covers the following configurations:

Configuration	Radios	Display	Memory	Data Capture Options	Operating System	Keypads
MC9590	WLAN: 802.11 a/b/g WPAN: Bluetooth v2.1 with EDR GPS: SiRF III	3.7" VGA Color	128 MB RAM/ 512 MB Flash	1D laser scanner, 2D imager, 1D laser scanner and camera or 2D imager and camera	Windows Mobile® 6.1 Classic	See Keypads below.
MC9596	WLAN: 802.11a/b/g WPAN: Bluetooth v2.1 with EDR WWAN: HSDPA GPS: SiRF III	3.7" VGA Color	128 MB RAM/ 512 MB Flash	1D laser scanner, 2D imager, 1D laser scanner and camera or 2D imager and camera	Windows Mobile® 6.1 Professional	See Keypads below.
MC9598	WLAN: 802.11a/b/g WPAN: Bluetooth v2.1 with EDR WWAN: EvDO Rev. A GPS: SiRF III	3.7" VGA Color	128 MB RAM/ 512 MB Flash	1D laser scanner, 2D imager, 1D laser scanner and camera or 2D imager and camera	Windows Mobile® 6.1 Professional	See Keypads below.

Keypads

The following keypads are available:

- Alpha Primary
- Telephony Numeric
- Calculator Numeric
- Alpha Numeric.

See [Appendix C, Keypads](#) for specific keypad information.

Software Versions

This guide covers various software configurations and references are made to operating system or software versions for:

- Adaptation Kit Update (AKU) version
- OEM version
- BTExplorer version
- Fusion version
- Phone version.

AKU Version

To determine the Adaptation Kit Update (AKU) version:

Tap **Start > Settings > System tab > About icon > Version tab**.

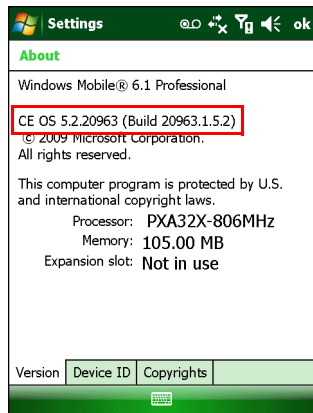

The second line lists the operating system version and the build number. The last part of the build number represents the AKU number. For example, *Build 20963.1.5.2* indicates that the device is running AKU version 1.5.2.

OEM Version

To determine the OEM software version:

Tap **Start > Settings > System tab > System Info icon > System tab**.

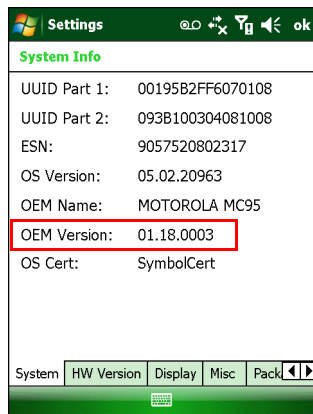

BTE Explorer Software



NOTE BTE Explorer application is only available when the StoneStreet One Bluetooth stack is enabled. Refer to the MC9500-K Mobile Computer Integrator Guide for information on selecting the Bluetooth stack.

To determine the BTE Explorer software version:

Tap **BTE Explorer icon > Show BTE Explorer > File > About**.



Fusion Software

To determine the Fusion software version:

Tap **Fusion Signal Strength** icon > **Wireless Status** > **Versions**.

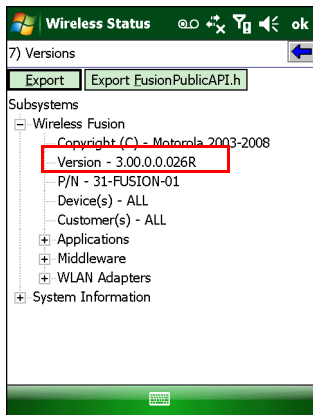

Phone Software

To determine the Phone software version:

On MC9596-K, tap **Start** > **Phone** > **Menu** > **Options** > **PhoneInfo** tab. On MC9598-K tap **Start** > **Phone** > **Menu** > **Options** > **Version Information** tab.

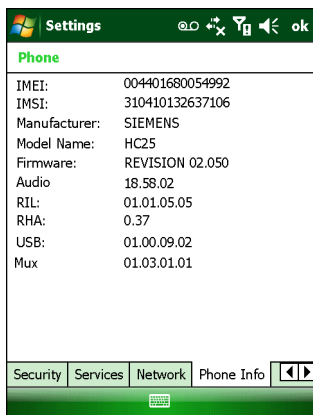

Chapter Descriptions

Topics covered in this guide are as follows:

- [Chapter 1, Getting Started](#) provides information on getting the MC9500-K up and running for the first time.
- [Chapter 2, Battery Management](#) provides information on the types of batteries and how to charge them.
- [Chapter 3, Using the MC9500-K](#) provides information on using the MC9500-K.
- [Chapter 4, Data Capture](#) provides instructions for using the MC9500-K to capture data using the laser scanner, imager and camera.
- [Chapter 5, Using the Phone](#) provides basic instructions for using the MC9500-K phone.
- [Chapter 6, Using GPS Navigation](#) provides information about GPS navigation with the MC9500-K.
- [Chapter 7, Using Bluetooth](#) explains Bluetooth functionality on the MC9500-K.
- [Chapter 8, Accessories](#) describes the available accessories and how to use them with the MC9500-K.
- [Chapter 9, Maintenance & Troubleshooting](#) includes instructions on cleaning and storing the MC9500-K, and provides troubleshooting solutions for potential problems during MC9500-K operation.
- [Appendix A, Technical Specifications](#) provides the technical specifications for the MC9500-K.
- [Appendix B, Voice Quality Manager](#) provides information on Voice Quality Manager software.
- [Appendix C, Keypads](#) provides keypad layouts and operation.

Notational Conventions

The following conventions are used in this document:

- “Mobile computer” refers to the Motorola MC9500-K hand-held computer.
- *Italics* are used to highlight the following:
 - Chapters and sections in this and related documents
 - Icons on a screen.
- **Bold** text is used to highlight the following:
 - Dialog box, window, and screen names
 - Drop-down list and list box names
 - Check box and radio button names
 - Key names on a keypad
 - Button names on a screen.
- Bullets (•) indicate:
 - Action items
 - Lists of alternatives
 - Lists of required steps that are not necessarily sequential
- Sequential lists (e.g., those that describe step-by-step procedures) appear as numbered lists.

Related Documents

- *MC9500-K Quick Start Guide*, p/n 72-118504-xx.
- *MC95XX Series Windows Mobile® 6.1 Regulatory Guide*, p/n 72-118502-xx.
- *MC9500-K Mobile Computer Integrator Guide*, p/n 72E-118503-xx.
- *Mobility Services Platform User Guide*, p/n 72E-100158-xx.
- Wireless Fusion Enterprise Mobility Suite User Guide for Version 3.00, p/n 72E-122495-xx.
- *Microsoft® Applications for Windows Mobile® 6 User Guide*, p/n 72E-108299-xx.
- *Enterprise Mobility Application Guide*, p/n 72E-68901-xx.
- *Enterprise Mobility Developer Kits (EMDKs)*, available at: <http://www.motorola.com/enterprisemobility/support>.
- Latest ActiveSync software, available at: <http://www.microsoft.com>.

For the latest version of this guide and all guides, go to: <http://www.motorola.com/enterprisemobility/manuals>.

Service Information

If you have a problem with your equipment, contact Motorola Enterprise Mobility support for your region. Contact information is available at: <http://www.motorola.com/enterprisemobility/contactsupport>.

When contacting Enterprise Mobility support, please have the following information available:

- Serial number of the unit (found on manufacturing label)
- Model number or product name (found on manufacturing label)
- Software type and version number.

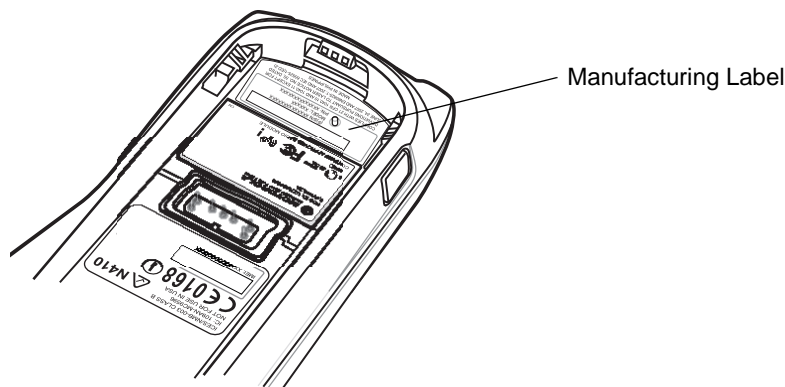

Motorola responds to calls by email, telephone or fax within the time limits set forth in support agreements.

If your problem cannot be solved by Motorola Enterprise Mobility Support, you may need to return your equipment for servicing and will be given specific directions. Motorola is not responsible for any damages incurred during shipment if the approved shipping container is not used. Shipping the units improperly can possibly void the warranty.

If you purchased your Enterprise Mobility business product from a Motorola business partner, contact that business partner for support.

Chapter 1 Getting Started

Introduction

This chapter explains how to set up the MC9500-K for the first time.

Unpacking

Carefully remove all protective material from the MC9500-K and save the shipping container for later storage and shipping.

Verify that you received the following:

- MC9500-K mobile computer
- 4800 mAh Lithium-ion battery
- Regulatory Guide
- Quick Start Guide.

Inspect the equipment for damage. If any equipment is missing or damaged, contact the Motorola Enterprise Mobility Support center immediately. See [page xviii](#) for contact information.

Prior to using the MC9500-K for the first time, remove the protective shipping film that covers the keypad and battery display.

Part of the MC9500-K

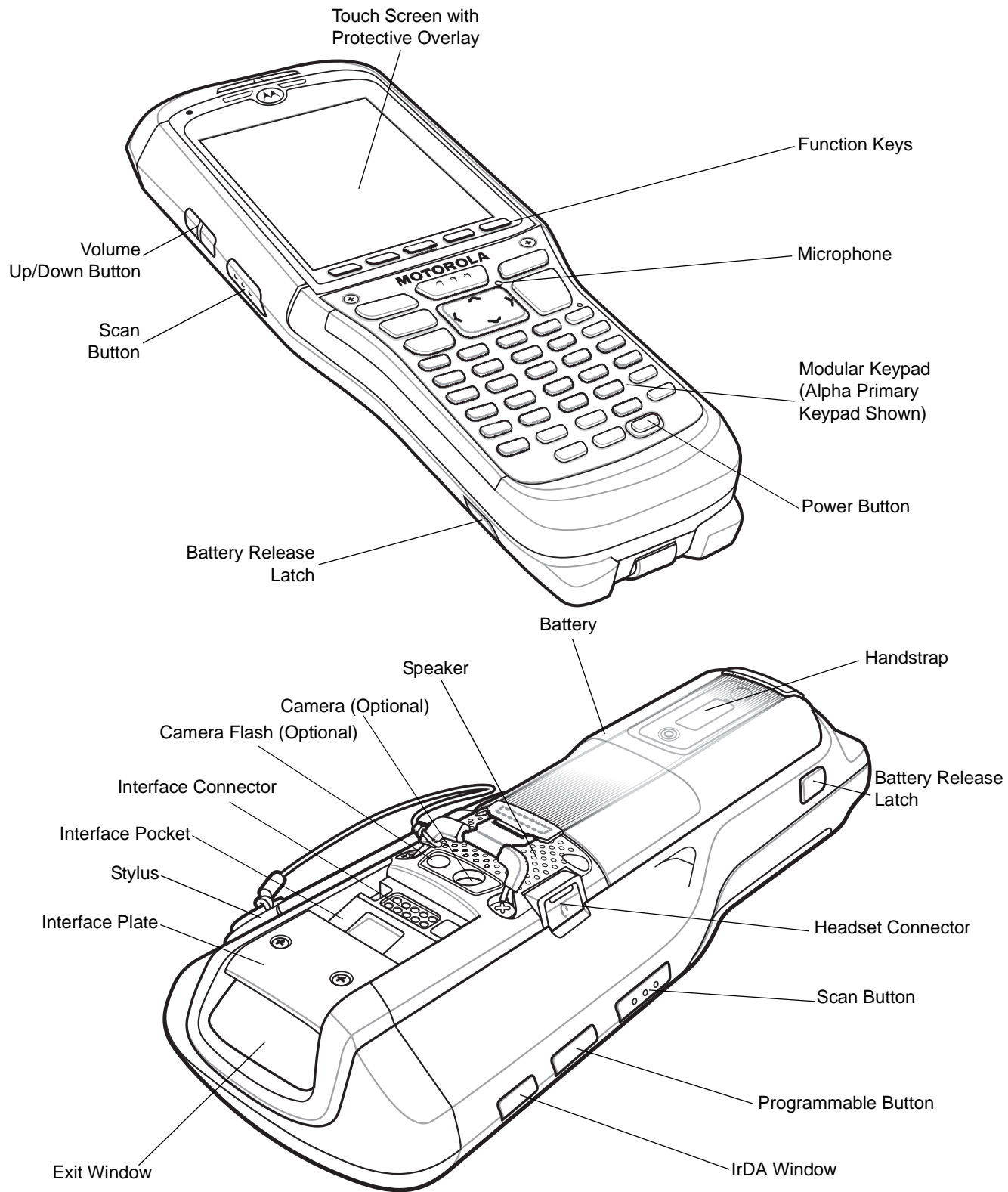

Figure 1-1 MC9500-K

Getting Started

To start using the MC9500-K for the first time:

- Install a microSD card (optional)
- Install the SIM card (MC9596 only)
- Install the battery.
- Charge the MC9500-K.

Installing a microSD Card

The microSD card slot provides secondary non-volatile storage. The slot is located under the battery pack. Refer to the documentation provided with the card for more information, and follow the manufacturer's recommendations for use.



CAUTION Follow proper ESD precautions to avoid damaging the microSD card. Proper ESD precautions include, but are not limited to, working on an ESD mat and ensuring that the operator is properly grounded.

To install the microSD card:

1. Remove the SD card cover using flathead screwdriver.

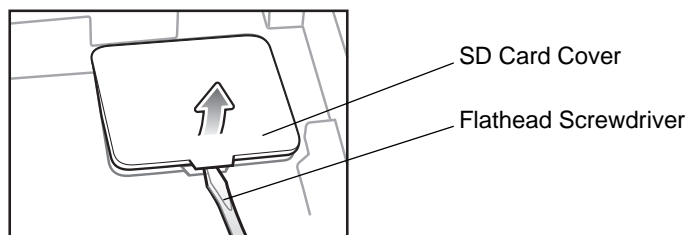

Figure 1-2 SD Card Cover Removal

2. Slide the microSD card holder door to the left to open.
3. Lift microSD card holder door.

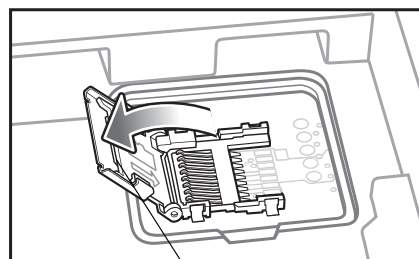

Figure 1-3 Lift microSD Card Holder Door

4. Insert the microSD card into card holder door ensuring that the card slides into the holding tabs on each side of the door.

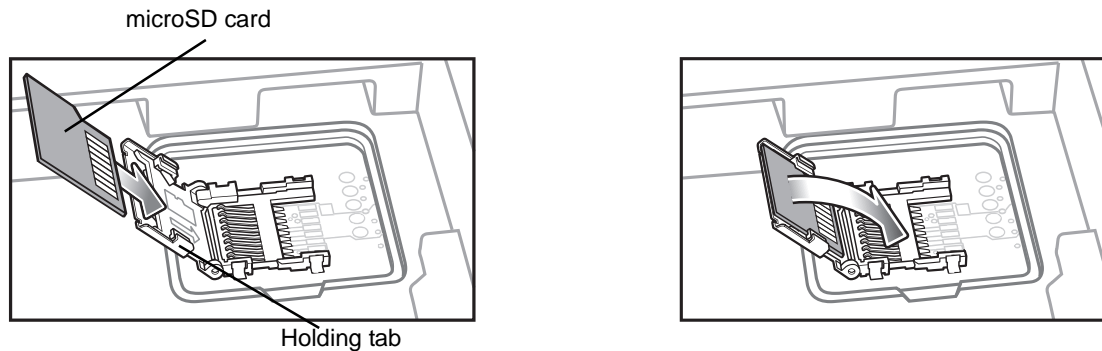

Figure 1-4 Insert microSD Card in Holder

5. Close the card holder door and slide to the right to lock into place.
6. Align the SD card cover over the access hole and press down until it snaps into place.

Installing the SIM Card

- ✓ **NOTE** MC9596 configuration only.

GSM phone service requires a Subscriber Identification Module (SIM) card, or smart card. Obtain the card from the your service provider. The card fits into the MC9596 and can contain the following information:

- Mobile phone service provider account details.
- Information regarding service access and preferences.
- Contact information, which can be moved to Contacts on the MC9596.
- Any additional services to which you have subscribed.

- ✓ **NOTE** For more information about SIM cards, refer to the service provider's documentation.

To install the SIM card:

1. Remove SIM card cover using flathead screwdriver.

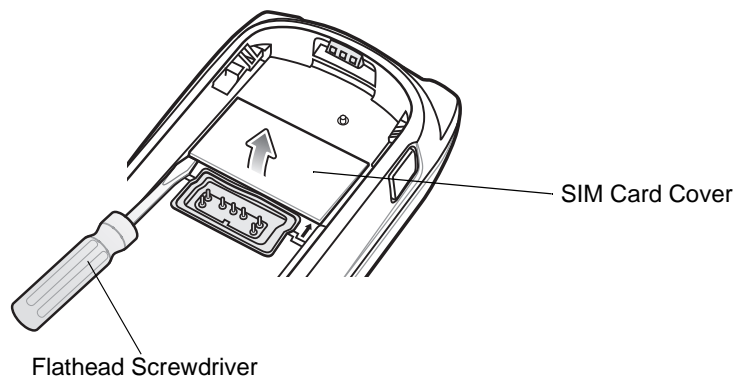

Figure 1-5 SIM Card Cover Removal

2. Slide the SIM card holder door to the left to unlock.

3. Lift the SIM card holder door.

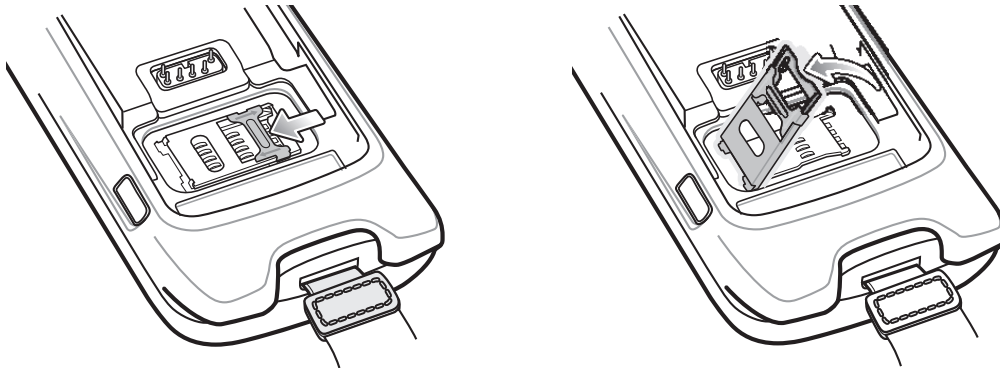

Figure 1-6 *Lifting the SIM Cover*

4. Insert the SIM card, as shown in [Figure 1-7](#) into the holder door with the contacts facing down and the card notch facing up.

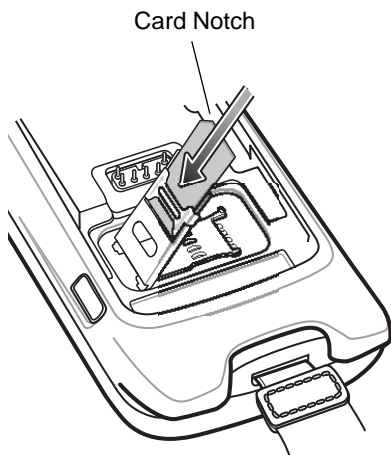

Figure 1-7 *Inserting the SIM Card*

5. Close SIM card holder door and slide to the right to lock into place.
6. Align the SIM card cover over the access hole and press down until it snaps into place.
7. Install the battery.
8. After completing initial MC9596 setup or after replacing a SIM card:
 - a. Press the red **Power** button.
 - b. On the Today screen, tap **Wireless Manager**.
 - c. Ensure Phone is on.
 - d. Press the red **Power** button to suspend the MC9596.
 - e. Perform a warm boot. See [Resetting the MC9500-K on page 3-3](#).
 - f. Make a call to verify cellular connection.



NOTE For detailed information about WWAN activation and settings, refer to the *MC9500-K Series Mobile Computer Integrator Guide*.

Installing the Battery

To install the battery:

1. Insert the battery, top first, into the battery compartment.
2. Press the battery down into the battery compartment until the battery release latches snap into place.

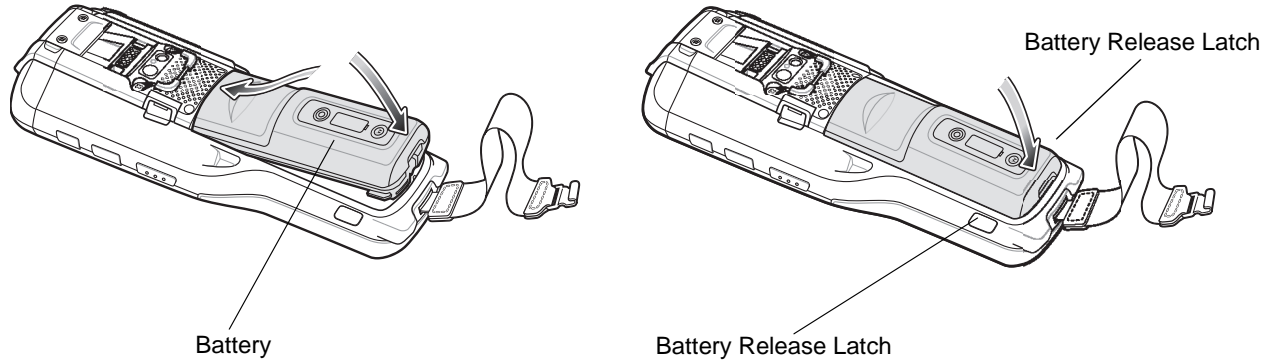

Figure 1-8 *Inserting the Battery*

3. The MC9500-K powers up automatically after inserting the battery, if the battery has been charged previously.

Charging the Battery



CAUTION Ensure that you follow the guidelines for battery safety described in [Battery Safety Guidelines on page 9-2](#).

Before using the MC9500-K for the first time, charge the battery using either a charging cable or a cradle:



NOTE For cable and cradle setup and charging procedures refer to the *MC9500-K Series Mobile Computer Integrator Guide*.

- USB Charging Cable
- Charge Only Cable
- Single Bay USB Cradle
- Four Bay Charge Only Cradle
- Four Bay Ethernet Cradle.

Align and hook the MC9500-K interface pocket onto the cradle's or cable's cleat. The battery automatically begins charging. See [Table 1-1](#) for charging indications. The 4800 mAh battery fully charges in less than six hours.

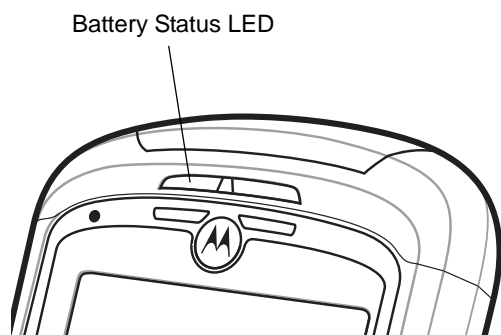

Battery Status LED

Table 1-1 LED Charge Indicators

Battery Status LED	Indication
Off	Indicates that the: <ul style="list-style-type: none"> • battery is not charging • MC9500-K is not connected correctly to the cradle or not connected to a power source. • cradle is not powered.
Slow Blinking Amber (1 blink every 2 seconds)	Indicates that a healthy battery is charging.
Slow Blinking Red (1 blink every 2 seconds)	Indicates that an unhealthy battery is charging.
Solid Green	Indicates that a healthy battery is fully charged.
Solid Red	Indicates that an unhealthy battery is fully charged.
Fast Blinking Amber (2 blinks/second)	Indicates a charging error, e.g.: <ul style="list-style-type: none"> • temperature is too low or too high. • charging has gone on too long without completion (typically eight hours).
Single Blink Amber (when Power button pressed)	Battery depleted.

The MC9500-K is equipped with a memory backup battery which automatically charges from the fully-charged main battery. When using the MC9500-K for the first time, the backup battery requires approximately 36 hours to fully charge. This is also true any time the backup battery is discharged, which occurs when the main battery is removed for several hours. The backup battery retains RAM data in memory for at least 15 minutes (at room temperature) when the MC9500-K's main battery is removed. When the MC9500-K reaches a very low battery state, the combination of main battery and backup battery retains RAM data in memory for at least 48 hours.

Charging Temperature

Charge batteries in temperatures from 0°C to 40°C (32°F to 104°F). Note that charging is intelligently controlled by the MC9500-K.

To accomplish this, for small periods of time, the MC9500-K alternately enables and disables battery charging to keep the battery at acceptable temperatures. The MC9500-K indicates when charging is disabled due to abnormal temperatures via its LED. See [Table 1-1](#).

Powering On the MC9500-K

After the MC9500-K is connected to power the splash screen displays for about a minute as the MC9500-K initializes its flash file system, then the calibration window appears.

Calibrating the Screen

- ✓ **NOTE** The Calibration screen can be accessed by pressing **CTRL** key - **BKSP** key or tapping **Start > Settings > Screen > Align Screen** button.

To calibrate the screen so the cursor on the touch screen aligns with the tip of the stylus:

1. Remove the stylus from its holder on the side of the MC9500-K.
2. Carefully press and briefly hold the tip of stylus on the center of each target that appears on the screen.
3. Repeat as the target moves around the screen, then tap the screen to continue.

Replacing the Battery

To replace the battery:



CAUTION Suspend the MC9500-K prior to removing the battery. Failure to properly remove the battery may cause the MC9500-K to cold boot and potential loss of data.

1. If the MC9500-K is in suspend mode, press the red **Power** button to wake the device.
2. Press the red **Power** button to suspend the MC9500-K.
3. Wait for red Decode LED to turn on and then turn off.
4. Unhook the handstrap.
5. Press the two battery release latches to release the battery. The battery ejects slightly.

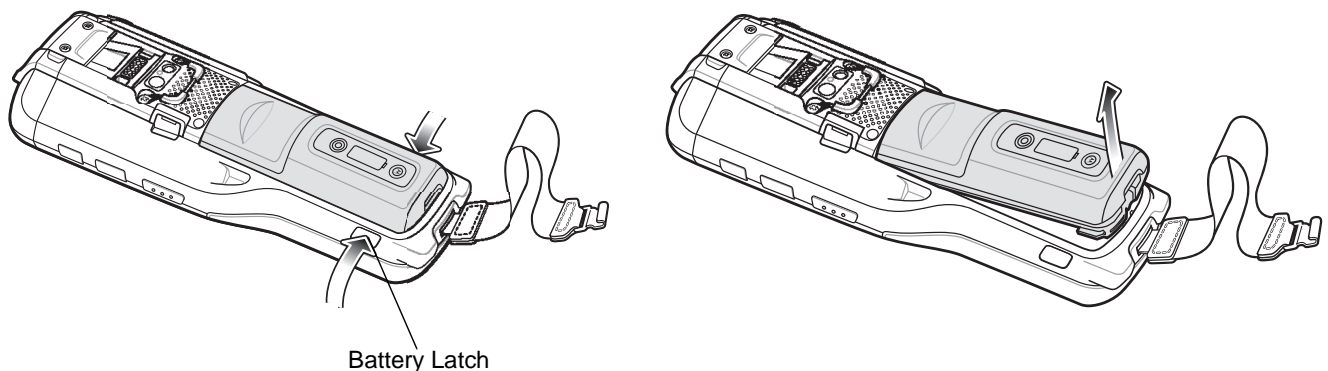

Figure 1-9 Removing the Battery

6. Lift the battery from the MC9500-K.
7. Insert the replacement battery, top first, into the battery compartment in the back of the MC9500-K.
8. Press the battery down until the battery release latches snap into place.

The MC9500-K powers up after inserting the battery.

Removing the microSD Card

To remove an microSD card:



CAUTION Suspend the MC9500-K prior to removing the battery. Failure to properly remove the battery may cause the MC9500-K to cold boot and potential loss of data.

1. If the MC9500-K is in suspend mode, press the red **Power** button to wake the device.
2. Press the red **Power** button to suspend the MC9500-K.
3. Wait for red Decode LED to turn on and then turn off.
4. Unhook the handstrap.
5. Remove the battery.
6. Remove the SD card cover using a flathead screwdriver.
7. Slide the SD card holder door to the left to unlock.
8. Lift the microSD card holder door.
9. Remove microSD card from holder.
10. Close the microSD card holder door.
11. Slide the microSD card holder door to the right to lock into place.
12. Align the SD card cover over the access hole and press down until it snaps into place.
13. Replace the battery.

Removing the SIM Card

To remove an SIM card:



CAUTION Suspend the MC9500-K prior to removing the battery. Failure to properly remove the battery may cause the MC9500-K to cold boot and potential loss of data.

1. If the MC9500-K is in suspend mode, press the red **Power** button to wake the device.
2. Press the red **Power** button to suspend the MC9500-K.
3. Wait for red Decode LED to turn on and then turn off.
4. Unhook the handstrap.
5. Remove the battery.
6. Remove the SIM card cover using a flathead screwdriver.
7. Slide the SIM card holder door to the left to unlock.
8. Lift the SIM card holder door.
9. Remove SIM card from holder.

10. Close the SIM card holder door.
11. Slide the SIM card holder door to the right to lock into place.
12. Align the SIM card cover over the access hole and press down until it snaps into place.
13. Replace the battery.

Chapter 2 Battery Management

Introduction

This chapter provides information on battery functionality, battery status indications, charging the MC9500-K, charging spare batteries and power saving techniques.

Battery Functionality

The 4800 mAh battery provides power to the MC9500-K and contains charging and status indications on the front of the battery. The indicators function differently depending upon the battery mode and allow the user to determine the health of the battery.

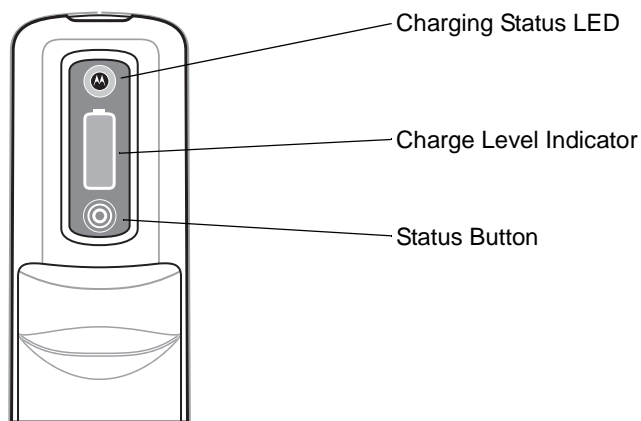

Figure 2-1 Battery

Charging Status LED indicates the charging status and health of the battery. The Charge Level Indicator indicates an unhealthy battery and the charge level of the battery.

Battery Health

A battery becomes unhealthy when the **Battery Usage Indication** reach a predefined threshold (end of usable life).

✓ **NOTE** The point at which a battery becomes unhealthy may vary depending upon the environment and charging conditions

The **Battery Usage Threshold** value can be changed. See the *MC9500-K Mobile Computer Integrator Guide* for more information.

When the battery becomes unhealthy, a dialog box displays on the MC9500-K. When this appears, tap **Dismiss**. Replace the battery as soon as possible. The battery Charge Level indicator display an “X” when the battery becomes unhealthy (see [Figure 2-3](#)). When charging an unhealthy battery in the MC9500-K, the Battery Status LED blinks red.

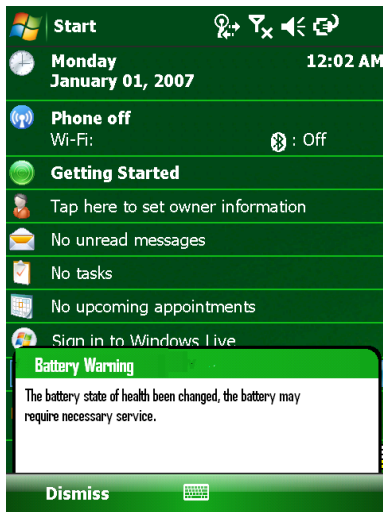

Figure 2-2 Battery Warning Dialog Box

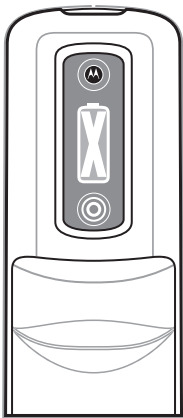

Figure 2-3 Unhealthy Battery Indication

Battery Status

The MC9500-K battery provides status information on the front of the battery that allows the user to make determination on what battery to use. The battery status indications vary depending upon the mode of the battery:

- Installed in an MC9500-K
- In a charger
- stand-alone.

Installed in an MC9500-K

✓ **NOTE** The Charge Level indicator does not display the charge level while the MC9500-K is charging.

When the 4800 mAh battery is installed in the MC9500-K, the user can view the charge level (with Status button press) and health of the battery (see [Figure 2-4](#)). The Battery Status LED is disabled when the battery is installed in the MC9500-K. If the battery is unhealthy, the Charge Level indicator displays an “X” (see [Figure 2-3](#)).

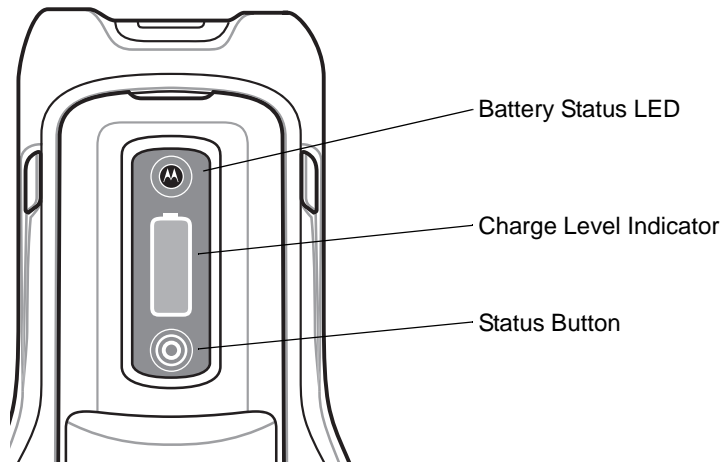
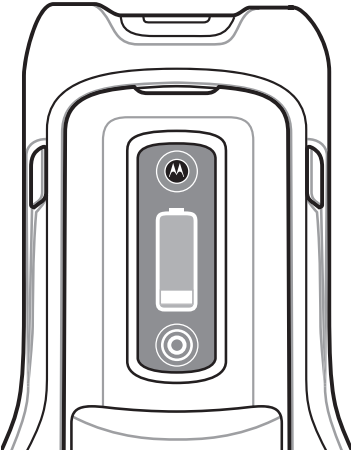







Figure 2-4 Battery in MC9500-K

Press the Status button to display the current battery charge level. It will display for five seconds and then turn off. [Table 2-1](#) list the Charge Level indications when the Status button is pressed.

Table 2-1 Charge Level Indicator

	Charge Level Indicator	Description
		Indicates that the remaining charge is approximately between 0% and 20%.
		Indicates that the remaining charge is approximately between 21% and 40%.
		Indicates that the remaining charge is approximately between 41% and 60%.
		Indicates that the remaining charge is approximately between 61% and 80%.
		Indicates that the remaining charge is approximately between 81% and 100%.

✓ **NOTE** The battery front panel is not visible when the MC9500-K is charging in a cradle. The battery front panel is visible when charging with a charging cable. The Charge Level indicator displays a “charging in mobile computer” indication (see [Table 2-2](#)).

Table 2-2 Battery in MC9500-K









Action	State	Healthy Battery		Unhealthy Battery	
		Battery Status LED	Charge Level Indicator	Battery Status LED	Charge Level Indicator
None	Not Charging	Off		Off	
Button Press	Not Charging	Off	 See Table 2-1 on page 2-4 for detailed information.	Off	 See Table 2-1 on page 2-4 for detailed information.

Table 2-2 Battery in MC9500-K (Continued)

Action	State	Healthy Battery		Unhealthy Battery	
		Battery Status LED	Charge Level Indicator	Battery Status LED	Charge Level Indicator
None	Charging in cradle or cable	Off		Off	
Button Press	Charging in cradle or cable	Off		Off	

The health of the battery can also be viewed on the MC9500-K Power applet. Tap **Start > Settings > Power icon > BatteryMgmt** tab.

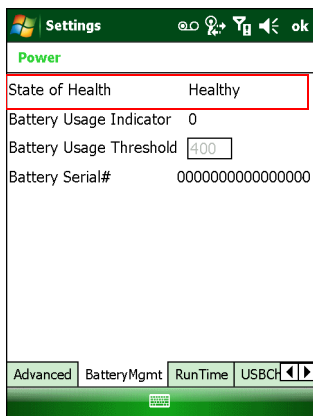

Figure 2-5 Power - BatteryMgmt Window

Table 2-3 BatteryMgmt Window

Item	Description
State of Health	Indicates the current state of the battery (Healthy or Unhealthy).
Battery Usage Indicator	Indicates the usage of the battery.
Battery Usage Threshold	Indicates the usage indicator threshold.
Battery Serial #	Displays the serial number of the battery.

For information on changing the Battery Usage Threshold, refer to the *MC9500-K Mobile Computer Integrator Guide*.

In a Charger

When the battery is in a Single Slot Battery Charger, Four Slot Battery Charger or Vehicle Battery Charger, the battery charging status and health is indicated on the front of the battery. If the charger is not powered, the battery acts as if it is in stand-alone mode. See [Stand-alone on page 2-8](#) for more information.

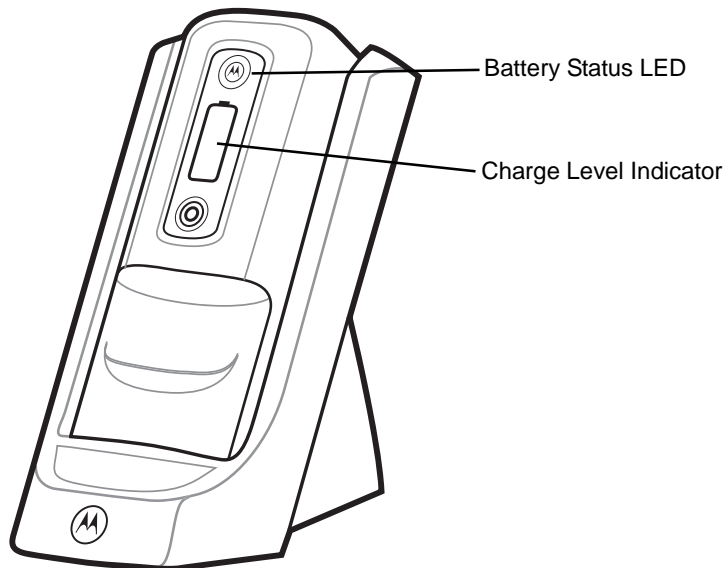

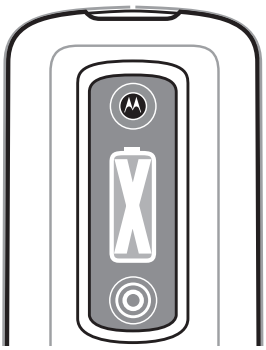







Figure 2-6 Battery in Single Slot Battery Charger

The Battery Status LED displays the current state of charging as described in [Table 2-4](#). The Charge Level indicator displays the charge level of a healthy battery as described in [Table 2-1](#).

With an unhealthy battery, an “X” appears on the display. To view the charge level, press the Status button. The display indicates the level of charge. After five seconds the display reverts to the “X” indication.





Table 2-4 Battery Status in Charger

State	Healthy Battery		Unhealthy Battery	
	Battery Status LED	Charge Level Indicator	Battery Status LED	Charge Level Indicator
None (charger not powered)	Off		Off	
Charging	Slow Blinking Amber (1 blink every 2 seconds)		Slow Blinking Red (1 blink every 2 seconds)	
Fully Charged	Solid Green		Solid Red	
Charging Error <ul style="list-style-type: none"> temperature is too low or too high. charging has gone on too long without completion (typically eight hours). 	Fast Blinking Amber (2 blinks/second)		Fast Blinking Amber (2 blinks/second)	

Stand-alone

When the battery is not installed in an MC9500-K or a charger, the charge status and health of the battery displays on the battery front panel. If the battery is unhealthy, an “X” appears in the Charge Level indicator. Press the Status button to view the health and charge level of the battery. The Battery Status LED lights and the Charge Level indicator display the charge level. After five seconds the LED turns off and the Charge Level indicator reverts to the previous display. See [Table 2-5](#) for Battery Status LED and Charge Level indicator descriptions.

Table 2-5 *Battery Status - Stand-alone*

Action	Healthy Battery		Unhealthy Battery	
	Battery Status LED	Charge Level Indicator	Battery Status LED	Charge Level Indicator
No Action	Off		Off	
Button Press	Solid Green	 See Table 2-1 on page 2-4 for detail information.	Solid Red	 See Table 2-1 on page 2-4 for detail information.

Charging the MC9500-K



CAUTION Ensure that you follow the guidelines for battery safety described in [Battery Safety Guidelines on page 9-2](#).

The MC9500-K is equipped with a memory backup battery which automatically charges from the fully-charged main battery. When using the MC9500-K for the first time, the backup battery requires approximately 36 hours to fully charge. This is also true any time the backup battery is discharged, which occurs when the main battery is removed for several hours. The backup battery retains RAM data in memory for at least 15 minutes (at room temperature) when the MC9500-K's main battery is removed. When the MC9500-K reaches a very low battery state, the combination of main battery and backup battery retains RAM data in memory for at least 36 hours.

To charge the battery, use either a cradle or charging cable. For cable and cradle setup and charging procedures refer to the *MC9500-K Mobile Computer Integrator Guide*.

To charge the battery:

1. Connect the charging accessory to the appropriate power source. See *MC9500-K Series Mobile Computer Integrator Guide* for setup information.
2. Align and hook the MC9500-K interface pocket onto the cradle's or cable's cleat. The MC9500-K begins charging. The Charging/Battery Status LED blinks while charging, then turns solid when fully charged (LED color depends upon health of the battery). See [Table 2-6](#) for charging indications. The 4800 mAh battery fully charges in less than six hours.

Table 2-6 Charging/Battery Status LED Indications









State	Healthy Battery	Unhealthy Battery
	MC9500-K LED Status	MC9500-K LED Status
None <ul style="list-style-type: none"> • battery is not charging • MC9500-K is not connected correctly to the cradle/cable or not connected to a power source. • cradle/cable is not powered. 	Off 	Off 
Charging	Slow Blinking Amber (1 blink every 2 seconds) 	Slow Blinking Red (1 blink every 2 seconds) 

Table 2-6 Charging/Battery Status LED Indications (Continued)

State	Healthy Battery	Unhealthy Battery
	MC9500-K LED Status	MC9500-K LED Status
Fully Charged	Solid Green 	Solid Red 
Charging Error <ul style="list-style-type: none"> temperature is too low or too high. charging has gone on too long without completion (typically eight hours). 	Fast Blinking Amber (2 blinks/second) 	Fast Blinking Amber (2 blinks/second) 

Charging a Spare Battery

Charge a spare battery using one of the following accessories:

- Single Slot Battery Charger
- Four Slot Battery Charger
- Vehicle Battery Charger.

To charge a spare battery:

1. Ensure the charger is connected to an appropriate power source.
2. Insert the spare battery into the charger. The spare battery begins charging.

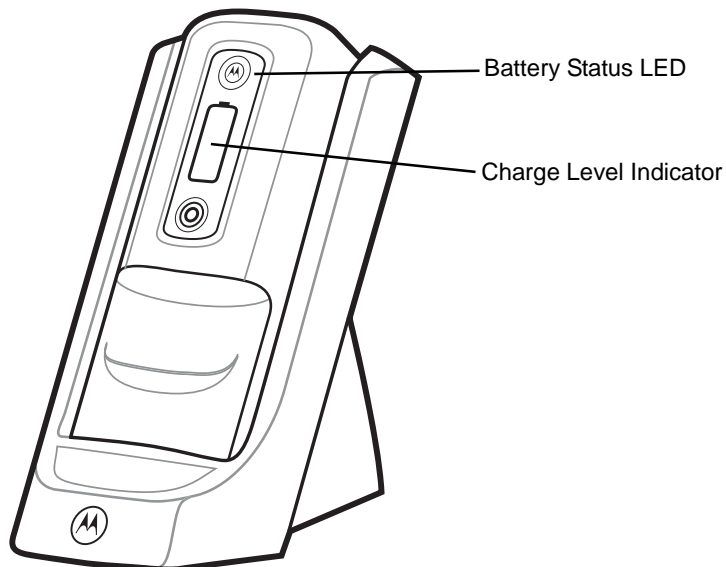









Figure 2-7 Spare Battery in Single Slot Battery Charger

The battery charging and health status is indicated on the front of the battery. [Table 2-7](#) lists the charging indications.

Table 2-7 Battery Charging Status Indications

State	Healthy Battery		Unhealthy Battery	
	Battery Status LED	Charge Level Indicator	Battery Status LED	Charge Level Indicator
None (charger not powered)	Off		Off	
Charging	Slow Blinking Amber (1 blink every 2 seconds)		Slow Blinking Red (1 blink every 2 seconds)	
Fully Charged	Solid Green		Solid Red	
Charging Error <ul style="list-style-type: none"> temperature is too low or too high. charging has gone on too long without completion (typically eight hours). 	Fast Blinking Amber (2 blinks/second)		Fast Blinking Amber (2 blinks/second)	

Charging Temperature

Charge batteries in temperatures from 0°C to 40°C (32°F to 104°F). Note that charging is intelligently controlled by the MC9500-K.

To accomplish this, for small periods of time, the MC9500-K alternately enables and disables battery charging to keep the battery at acceptable temperatures. The MC9500-K indicates when charging is disabled due to abnormal temperatures via its LED.

Power Saving Techniques

Observe the following battery saving tips:

- Leave the MC9500-K connected to AC power at all times when not in use.
- Set the MC9500-K to turn off after a short period of non-use.
- Set the backlight to turn off after a short period of non-use.
- Turn off all wireless activities when not in use.

Changing the Power Settings

To set the MC9500-K to turn off after a short period of non-use:

1. Tap **Start > Settings > System** tab > **Power** icon > **Advanced** tab.
2. Select the **On battery power: Turn off device if not used for** check box and select a value from the drop-down list.
3. Select **ok**.

Changing the Backlight Settings

To change the backlight settings in order to conserve more battery power:

1. Tap **Start > Settings > System** tab > **Backlight** icon > **Battery Power** tab.
2. Select the **Disable backlight if device is not used for** check box and select a value from the drop-down list.
3. Select the **Brightness** tab.
4. Tap the **Disable backlight** check box to turn off the display backlight, or use the slider to set a low value for the backlight.
5. Select **ok**.

Changing the Keypad Backlight Settings

To change the keypad backlight settings in order to conserve more battery power:

1. Tap **Start > Settings > System** tab > **Keypress** icon > **Battery Power** tab.
2. Select the **On battery power: Disable keylight if device if not used for** check box and select a value from the drop-down list.
3. Select the **Advanced** tab.
4. Tap the **Disable keylight** check box to turn off the keypad backlight.
5. Select **ok**.

Turning Off the Radios

Windows Mobile 6 devices include **Wireless Manager**, which provides a simple method of enabling, disabling, and configuring all the device's wireless capabilities in one place.

To open **Wireless Manager**, tap the **Connectivity** icon or tap **Wireless Manager** on the **Today** screen.

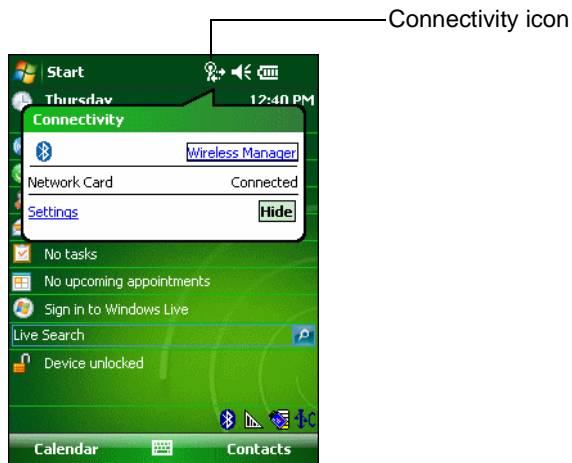

Figure 2-8 *Opening Wireless Manager*

Select **Wireless Manager**.

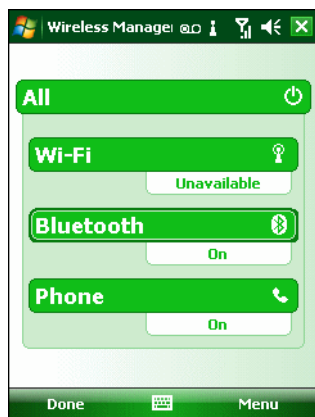

Figure 2-9 *Wireless Manager Window*



NOTE Wireless connection options vary depending upon configurations.

To enable or disable a wireless connection, tap the specific button.

To enable or disable all wireless connections, tap and hold the **All** button.

To configure settings for a connection, tap **Menu**.



Figure 2-10 Wireless Manager Menu

Chapter 3 Using the MC9500-K

Introduction

This chapter explains the indicators, buttons, status icons, and controls on the MC9500-K, and provides basic instructions for using the device.

LED Indicators

The MC9500-K has three LED indicators. The Decode LED indicates scanning status. The Battery Status LED indicates battery charging and health status. The WAN Radio Status LED indicates WAN radio status. [Table 3-1](#) describes the LED indications.

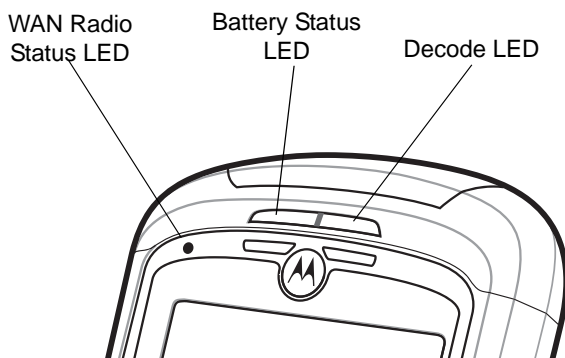

Figure 3-1 LED Indicators

Table 3-1 LED Indications

LED State	Indication
Decode LED	
Solid Green	Successful decode/capture.
Solid Red	Scanning/imaging in process.
Blinks Red	After the Power button is pressed, turns on and then off to indicate that the battery can be removed.

Table 3-1 LED Indications (Continued)

LED State	Indication
Off	Not enabled.
Battery Status LED	
Off	Indicates that the: <ul style="list-style-type: none"> • battery is not charging • MC9500-K is not connected correctly to the cradle or not connected to a power source. • cradle is not powered.
Slow Blinking Amber (1 blink every 2 seconds)	Indicates that a healthy battery is charging.
Slow Blinking Red (1 blink every 2 seconds)	Indicates that an unhealthy battery is charging.
Solid Green	Indicates that a healthy battery is fully charged.
Solid Red	Indicates that an unhealthy battery is fully charged.
Fast Blinking Amber (2 blinks/second)	Indicates a charging error, e.g.: <ul style="list-style-type: none"> • temperature is too low or too high. • charging has gone on too long without completion (typically eight hours).
Single Blink Amber (when Power button pressed)	Battery depleted.
Blinking Amber (when Power button pressed)	Battery over-temperature condition.
WAN Radio Status LED (MC9596 or MC9598 only)	
Slow Blinking Green	WAN activity.
Off	No WAN activity.



NOTE For information about scanning/decoding, see [Chapter 4, Data Capture](#). For information about WAN radio status and settings, see [Chapter 5, Using the Phone](#), or refer to the *MC9500-K Mobile Computer Integrator Guide*.

Resetting the MC9500-K

There are two reset functions, warm boot and cold boot. A warm boot restarts the MC9500-K by closing all running programs. A cold boot also restarts the MC9500-K, and also initializes some drivers. Data saved in flash memory or a memory card is not lost.

If the MC9500-K is not functioning properly, perform a warm boot first. If the MC9500-K still does not respond, perform a cold boot.

Performing a Warm Boot

Hold down the red **Power** button for approximately five seconds. As soon as the MC9500-K starts to boot release the **Power** button.

Performing a Cold Boot

To perform a cold boot, simultaneously press the red **Power** button and the 1 and 9 keys.

Waking the MC9500-K

The wake-up conditions define what actions wake up the mobile computer after it has gone into suspend mode. The mobile computer can go into suspend mode by either pressing the Power button or automatically by Control Panel time-out settings. These settings are configurable and the factory default settings are shown in [Table 3-2](#) are subject to change/update. Tap **Start > Setting > System > Power icon > Wakeup** tab to configure these settings.

Table 3-2 Wake-up Default Settings

Condition for Wake-up	Power Button	Automatic Time-out
AC power is applied.	No	Yes
Mobile computer is inserted into a cradle.	No	Yes
Mobile computer is removed from a cradle.	No	Yes
Mobile computer is connected to a USB device.	Yes	Yes
A key is pressed.	No	Yes
The scan triggered is pressed.	No	Yes
The screen is touched.	No	No
Bluetooth communication	Yes	Yes
On motion	No	No
Incoming phone call (MC9596 and MC9598 only)	Yes	Yes

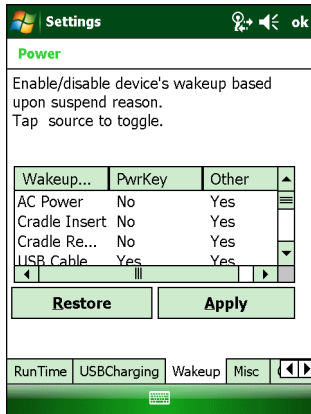

Figure 3-2 Power Settings Wakeup Tab

Locking the MC9500-K

You can lock the MC9500-K by disabling key presses and screen tap or by requiring a password.

Keypad Locking

Locking the MC9500-K turns off keyboard and touch screen functionality. This is helpful when the MC9500-K is turned on and you want to prevent accidental key presses.

To lock the device, tap the **Device unlocked** icon. The icon changes to locked.

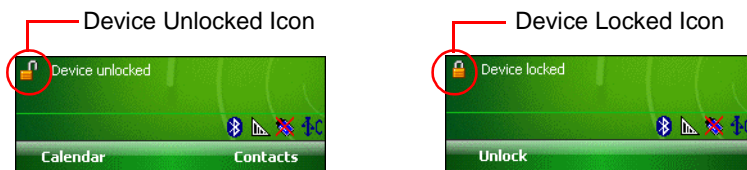

Figure 3-3 Device Locked/Unlocked Icons

To unlock the device and free it for use, tap **Unlock**.

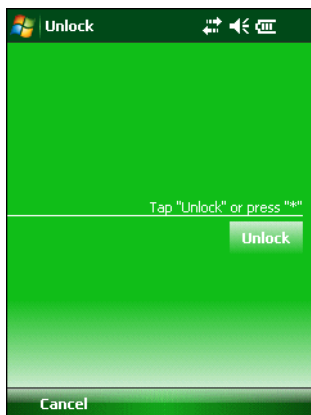

Figure 3-4 Unlock Device Window

Tap **Unlock** on the **Unlock** window.

- ✓ **NOTE** You can make emergency calls even when the MC9596-K or MC9598-K is locked. See [Making an Emergency Call on page 5-9](#) for more information.

Password Locking

Use the **Password** window to set a password to disable unauthorized access to the MC9500-K.

- ✓ **NOTE** If the device is configured to connect to a network, use a strong (difficult to figure out) password to help protect network security. Password cracking tools continue to improve and the computers used to crack passwords are more powerful than ever.

1. Tap **Start > Settings > Personal tab > Lock icon > Password tab**.

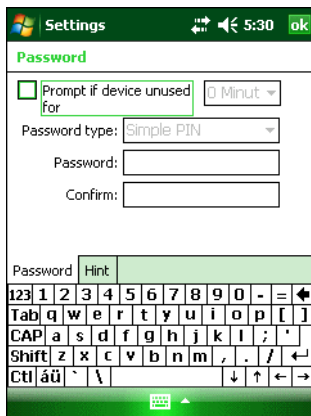

Figure 3-5 Password Window - Password Tab

2. Select **Prompt if device unused for** check box to enable password protection.
3. From the drop-down list, select a time value for the protection to take affect after non-use.
4. From the **Password type:** drop-down list, select either **Simple PIN** or **Strong alphanumeric**.
5. For a simple password, enter a four-digit password in the **Password** field.
For a stronger password:
 - a. Enter a seven character password in the **Password:** field. A strong password must contain at least seven characters and contain at least three of the following: uppercase and lowercase letters, numerals, and punctuation.
 - b. Re-enter the password in the **Confirm:** field.
6. Tap **ok**.
7. To set a hint to remember the password, tap the **Hint** tab.



Figure 3-6 Password Window - Hint Tab

8. In the text box, enter a hint for a password reminder.
9. Tap **ok**.

When the MC9500-K is not used for a period of time and the user tries to access the device, the Password window appears.

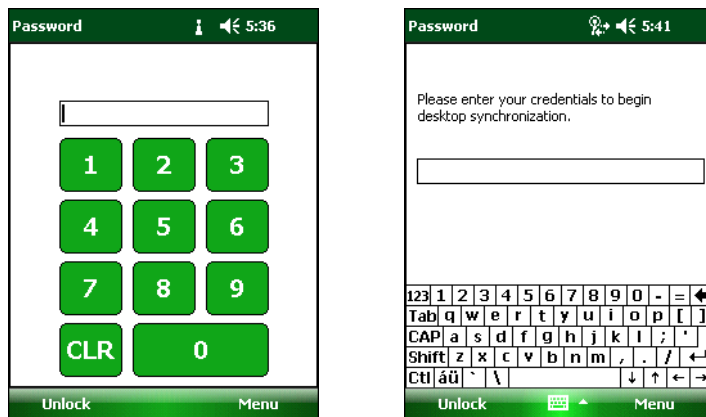

Figure 3-7 Enter Password Windows

Enter the password to un-lock the device.

Tap **Unlock**.

Keypads

The MC9500-K offers four types modular keypad configurations. See [Appendix C, Keypads](#) for keypad functionality.

Function Buttons

The MC9500-K's buttons perform certain functions.

- **Power:** Press the red **Power** button to place the MC9500-K into suspend mode or wake from suspend mode. Also use the **Power** button to reset the MC9500-K by performing a warm or cold boot. See [Resetting the MC9500-K on page 3-3](#).
- **Scan/Action:** Press to scan bar codes or capture images. See [Chapter 4, Data Capture](#). Or, press to open an application or perform a function. See the *Microsoft® Applications for Mobile 6 User Guide* to set an application to open.
- **Volume Up/Down:** Press to increase or decrease the MC9500-K's volume.
- **Action:** Press to open an application or perform a function. See the *Microsoft® Applications for Windows Mobile 6 User Guide* to set an application to open.
- **Green Key:** Press to open the Phone Dialer window or answer an incoming call or place a call on hold.
- **Red Key:** Press to end a call.
- **Function Keys:** Programmable functions for performing specific applications.
 - F1 - Left soft key
 - F2 - Right soft key
 - F3 - Talk (MC9596/8 only)
 - F4 - End Call (MC9596/8 only)
 - F5 - Refreshes the screen in Internet Explorer and File Explorer.
 - F6 - Volume Up.

Stylus

Use the MC9500-K stylus to select items and enter information. The stylus functions as a mouse.

- **Tap:** Touch the screen once with the stylus to press option buttons and open menu items.
- **Tap and Hold:** Tap and hold the stylus on an item to see a list of actions available for that item. On the pop-up menu that appears, tap the action to perform.
- **Drag:** Hold the stylus on the screen and drag across the screen to select text and images. Drag in a list to select multiple items.



CAUTION To prevent damage to the screen, do not use any device other than the Motorola-provided stylus.

Entering Data

When entering data on the keypad, use either the single-hand method or the two-hand method as shown in [Figure 3-8](#).

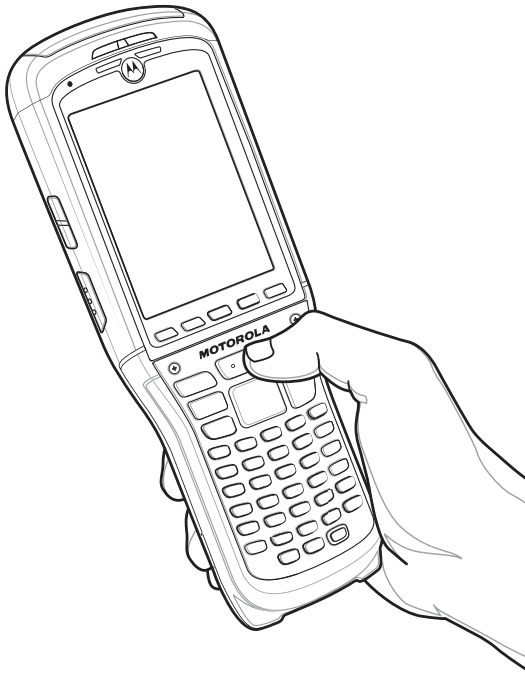

Single-hand Method



Two-hand Method

Figure 3-8 *Entering Data on the Keypad*

Interactive Sensor Technology

This section describes the functionality of the Interactive Sensor Technology (IST) feature on the MC9500-K.

The IST supports the following features.

- Power Management – manage power by configuring IST to control switching on/off the backlight, control suspend mode of the MC9500-K by monitoring motion and orientation.
- Display Orientation – switch the screen orientation to either landscape or portrait depending on the MC9500-K orientation.
- Free Fall Detection – monitors free fall duration and records the time and type of the drop event.

Power Management

The MC9500-K orientation and motion sensitive data can be used as an indicator of MC9500-K usage and can be used to manage the battery power of the mobile computer. For example, IST can be configured to control the backlight on and off functionality or go into suspend according to a user gesture by placing screen facing down. It can also be used to keep the MC9500-K active while it is in movement to prevent it from quickly going into suspend mode while in use.

Display Orientation

The screen can be rotated between portrait and landscape modes automatically, depending on the physical orientation of the MC9500-K. For example, if the MC9500-K is rotated 90° counterclockwise, IST rotates the display counterclockwise 90° so that the screen display appears correct.

This functionality is achieved by monitoring screen angle and rotating the display to counter any changes. IST only rotates the screen in multiples of 90°.

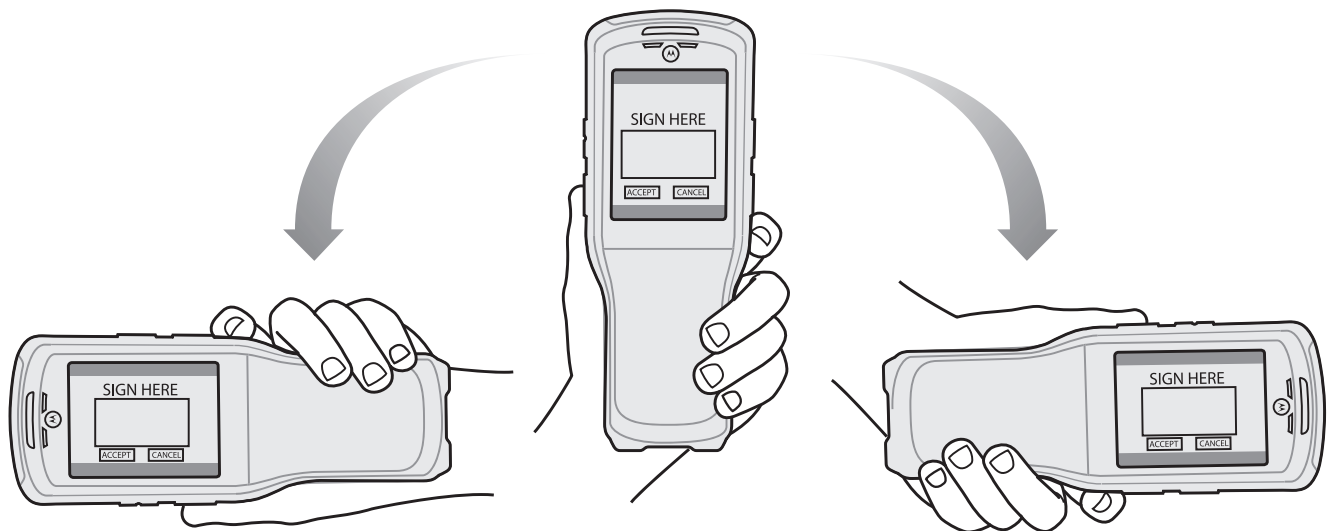

Figure 3-9 *Display Orientation*

Free Fall Detection

IST continuously monitors gravitational force on the MC9500-K according to its current position. When the MC9500-K free falls, IST detects the absence of gravitational force and records the event data if it detects a free fall more than 450 ms, which may indicate nearly a one meter drop. This data can be used as an indicator of potential abuse or misuse.

IST features a log for recording the free fall events. This log records the date, time and the time period of the free fall.

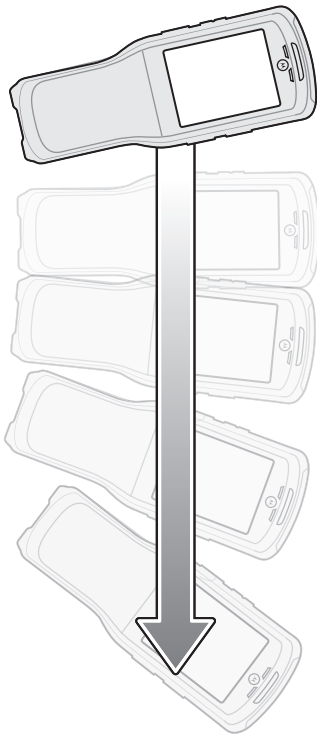

Figure 3-10 *Free Fall Detection*

Today Screen

The Today screen displays important information, such as upcoming appointments and status indicators. Tap a section on the screen to open the associated program. Alternatively, tap **Start > Today** to display the **Today** screen.

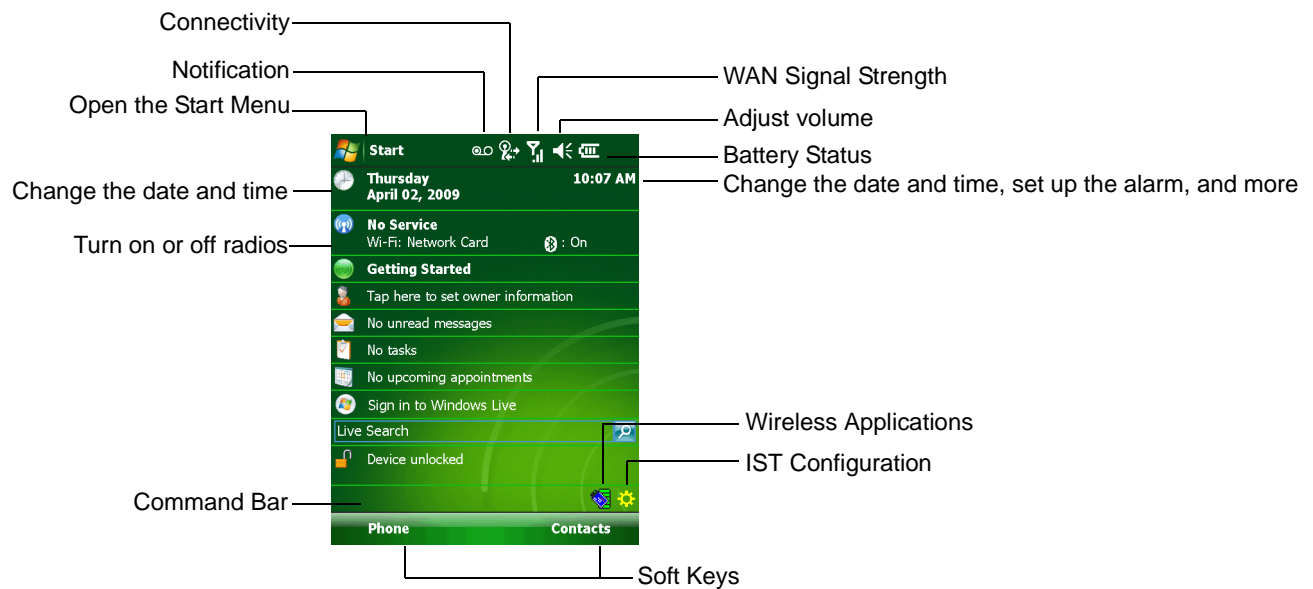

Figure 3-11 Today Screen

To customize the **Today** screen, tap **Start > Settings > Today** icon. Use the **Appearance** tab to customize the background and the **Items** tab to change the list and order of items that appear on the screen.

Status Icons

The Navigation bar at the top of the screen can contain the status icons listed in [Table 3-3](#).

Table 3-3 Status Icons

Icon	Function	Description
	Notification	Backup Battery Low.
		Notification that one or more instant messages were received.
		Notification that one or more e-mail/text messages were received.
		Notification that one or more voice messages were received.
		There are more notification icons than can be displayed. Tap to display remaining icons.
		Indicates a reminder of an upcoming calendar event.

Table 3-3 Status Icons (Continued)



















































Icon	Function	Description
	Connectivity	Connection is active.
		Connection is not active.
		Synchronization is occurring.
		Wi-Fi available.
		Wi-Fi in use.
		HSDPA available. (MC9596 only)
		HSDPA connecting. (MC9596 only)
		3G available. (MC9596 only)
		3G connecting. (MC9596 only)
		GPRS available. (MC9596 only)
		GPRS connecting. (MC9596 only)
		EGPRS available. (MC9596 only)
		EGPRS connecting. (MC9596 only)
		EVDO connecting. (MC9598 only)
		1xRTT available. (MC9598 only)
		EVDO Rev. 0 available. (MC9598 only)
	EVDO Rev. A available. (MC9598 only)	
	Dormant State - no data transmission during a 1x or EVDO connection. (MC9598 only)	

Table 3-3 Status Icons (Continued)

Icon	Function	Description
	WAN	Call missed.
		Dialing while no SIM card is installed.
		Voice call in progress.
		Calls are forwarded.
		Call on hold.
		Speakerphone is on.
		Antenna/signal icon: wireless on/good signal.
		Antenna/signal icon: wireless off.
		Antenna/signal icon: no service or searching.
		HSDPA in use. (MC9596 only)
		3G in use. (MC9596 only)
		GPRS in use. (MC9596 only)
		EGPRS in use. (MC9596 only)
		EVDO in use. (MC9598 only)
		Roaming.
	SIM Card not installed. (MC9596 only)	
	Speaker	All sounds are on.
		All sounds are off.
		Vibrate is on.
	Battery	Main battery is charging.
		Battery power completely depleted.
		Main battery is low.
		Main battery level.
	Time and Next Appointment	Displays current time in analog or digital format.

The Command Bar at the bottom of the screen can contain the application icons listed in [Table 3-4](#).

Table 3-4 *Command Bar Icons*

Icon	Description	
	Wireless connection status	Indicates WLAN signal strength.
	Out-of-network range (not associated)	Indicates no wireless LAN network connection. Notify the network administrator.
	No wireless LAN network card detected	Indicates Wireless LAN disabled or radio disabled. Notify the network administrator.
	Bluetooth Enabled	Indicates the Bluetooth radio is on. (Displays only if the StoneStreet One Bluetooth stack is enabled)
	Bluetooth Disabled	Indicates the Bluetooth radio is off. (Displays only if the StoneStreet One Bluetooth stack is enabled)
	Bluetooth Connection	Indicates the Bluetooth radio is connected to another Bluetooth device. (Displays only if the StoneStreet One Bluetooth stack is enabled)
	ActiveSync	Indicates an active serial connection between the MC9500-K and the host computer.
	IST icon	Opens the IST settings menu.

Programs

[Table 3-5](#) lists the default programs on the **Start** menu.

Table 3-5 *Programs in the Start Menu*







Icon	Name	Description
	Office Mobile	Use the complete suite of Microsoft® Office applications for your mobile device. Excel Mobile - Create new workbooks or view and edit Microsoft® Excel® workbooks. OneNote Mobile - Create new notes or view existing notes. PowerPoint Mobile - View Microsoft® PowerPoint® slides and presentations. Word Mobile - Create, view, and edit Microsoft® Word documents. Refer to the <i>Microsoft Applications for Windows Mobile 6 User Guide</i> for more information.
	Calendar	Keep track of appointments and create meeting requests. Refer to the <i>Microsoft Applications for Windows Mobile 6 User Guide</i> for more information.

Table 3-5 Programs in the Start Menu (Continued)

Icon	Name	Description
	Contacts	Keep track of friends and colleagues. Refer to the <i>Microsoft Applications for Windows Mobile 6 User Guide</i> for more information.
	Internet Explorer Mobile	Browse Web and WAP sites as well as download new programs and files from the Internet. Refer to the <i>Microsoft Applications for Windows Mobile 6 User Guide</i> for more information.
	Messaging	Send and receive e-mail and text messages. Refer to the <i>Microsoft Applications for Windows Mobile 6 User Guide</i> for more information.
	Phone	Make and receive calls, switch between calls, and set up conference calling. See Chapter 5, Using the Phone for more information. MC9596 and MC9598 only.
	Help	See Help topics for the current screen or program.

[Table 3-6](#) lists programs that are listed in the Programs window.

Table 3-6 Programs in Program Window







Icon	Name	Description
	ActiveSync	Synchronize information between the MC9500-K and a host computer or the Exchange Server. Refer to the <i>MC9500-K Series Mobile Computer Integrator Guide</i> for more information.
	AirBEAM	Allows specially designed software packages to be transferred between a host server and the MC9500-K. Refer to the <i>MC9500-K Series Mobile Computer Integrator Guide</i> for more information.
	BT Information	Displays information about the Bluetooth radio. See Chapter 7, Using Bluetooth .
	BTE Explorer	Manages StoneStreet One Bluetooth connections. Refer to the <i>MC9500-K Series Mobile Computer Integrator Guide</i> for more information. Appears only if the StoneStreet One Bluetooth stack is enabled.
	Calculator	Perform basic arithmetic and calculations, such as addition, subtraction, multiplication, and division. Refer to the <i>Microsoft Applications for Windows Mobile 6 User Guide</i> for more information.
	File Explorer	Organize and manage files on your device. Refer to the <i>Microsoft Applications for Windows Mobile 6 User Guide</i> for more information.
	Getting Started	Provides quick links for setting the devices clock, setting up e-mail, setting a device password, setting a background image and transferring music. Refer to the <i>Microsoft Applications for Windows Mobile 6 User Guide</i> for more information.

Table 3-6 Programs in Program Window (Continued)















Icon	Name	Description
	Internet Sharing	Connect a notebook computer to the Internet using the MC9500-K's data connection.
	Messenger	Use this mobile version of Windows Live Messenger. Refer to the <i>Microsoft Applications for Windows Mobile 6 User Guide</i> for more information.
	DEMO	Provides a web link to Motorola's featured demos for the MC9500-K.
	Modem Link	Enables the MC9500-K to be used as a modem.
	MSP Agent	Interacts with MSP agents to collect monitoring and asset information to enable the configuration, provisioning, monitoring and troubleshooting of the MC9500-K. Refer to the <i>Mobility Services Platform User Guide</i> for more information.
	Notes	Create handwritten or typed notes, drawings, and voice recordings. Refer to the <i>Microsoft Applications for Windows Mobile 6 User Guide</i> for more information.
	Pictures & Videos	View and manage pictures, animated GIFs, and video files. Refer to the <i>Microsoft Applications for Windows Mobile 6 User Guide</i> for more information.
	Rapid Deployment Client	Facilitates software downloads from a Mobility Services Platform Console FTP server to the MC9500-K. Refer to the <i>MC9500-K Mobile Computer Integrator Guide</i> for more information.
	Remote Desktop Mobile	Log onto Windows NT server type computers and use all of the programs that are available on that computer from the MC9500-K.
	Search	Search contacts, data, and other information on your MC9500-K. Refer to the <i>Microsoft Applications for Windows Mobile 6 User Guide</i> for more information.
	SIM Toolkit	Manage the contacts that are stored on your SIM card. Copy SIM contents to Contacts on the MC9500-K. See Chapter 5, Using the Phone for more information. MC9596 and MC9598 only.
	Task Manager	Enables viewing of memory and CPU allocations and stops running processes. Refer to the <i>Microsoft Applications for Windows Mobile 6 User Guide</i> for more information.
	Tasks	Keep track of your tasks. Refer to the <i>Microsoft Applications for Windows Mobile 6 User Guide</i> for more information.

Table 3-6 Programs in Program Window (Continued)

Icon	Name	Description
	Windows Live	Use this mobile version of Windows Live™ to find information on the web. Refer to the <i>Microsoft Applications for Windows Mobile 6 User Guide</i> for more information.
	Windows Media	Play back audio and video files. Refer to the <i>Microsoft Applications for Windows Mobile 6 User Guide</i> for more information.

Settings

[Table 3-7](#) lists control applications pre installed on the MC9500-K. Tap **Start > Settings** to open the **Settings** window.

Table 3-7 Settings in the Setting Window









Icon	Name	Description
Personal Tab		
	Buttons	Assign a program to a button. Refer to the <i>Microsoft Applications for Windows Mobile 6 User Guide</i> for more information.
	Input	Set options for each of the input methods. Refer to the <i>Microsoft Applications for Windows Mobile 6 User Guide</i> for more information.
	Lock	Set a password for the MC9500-K.
	Menus	Set what programs appear in the Start menu. Refer to the <i>Microsoft Applications for Windows Mobile 6 User Guide</i> for more information.
	Owner Information	Enter personal information on the MC9500-K. Refer to the <i>Microsoft Applications for Windows Mobile 6 User Guide</i> for more information.
	Phone	Make and receive calls, switch between calls, and set up conference calling. See Chapter 5, Using the Phone for more information. See Chapter 5, Using the Phone for more information. MC9596 and MC9598 only.
	Sounds & Notifications	Enable sounds for events, notifications, and more, and set the type of notification for different events. Refer to the <i>Microsoft Applications for Windows Mobile 6 User Guide</i> for more information.
	Today	Customize the appearance and the information to be displayed on the Today screen. Refer to the <i>Microsoft Applications for Windows Mobile 6 User Guide</i> for more information.

Table 3-7 Settings in the Setting Window (Continued)























Icon	Name	Description
System Tab		
	About	View basic information such as the Windows Mobile® version and type of processor used on the MC9500-K. Refer to the <i>Microsoft Applications for Windows Mobile 6 User Guide</i> for more information.
	Backlight	Set the display backlight time-out and adjust brightness. Refer to the <i>Microsoft Applications for Windows Mobile 6 User Guide</i> for more information.
	Certificates	See information about certificates installed on the MC9500-K. Refer to the <i>Microsoft Applications for Windows Mobile 6 User Guide</i> for more information.
	Clock & Alarms	Set the device clock to the date and time of your locale or to a visiting time zone when you're traveling. Alarms can also be set at specified days and times of a week. Refer to the <i>Microsoft Applications for Windows Mobile 6 User Guide</i> for more information.
	Customer Feedback	Submit feedback on the Windows Mobile 6.1 software. Refer to the <i>Microsoft Applications for Windows Mobile 6 User Guide</i> for more information.
	Encryption	Allow files on a storage card to be encrypted. Encrypted files are readable only on your device.
	Error Reporting	Enable or disable the device's error reporting function. When this function is enabled and a program error occurs, technical data about the state of the program and your computer is logged in a text file and delivered to Microsoft's technical support if you choose to send it. Refer to the <i>Microsoft Applications for Windows Mobile 6 User Guide</i> for more information.
	External GPS	Set the appropriate GPS communication ports, if required. You may need to do this when there are programs on your device that access GPS data or you have connected a GPS receiver to the MC9500-K.
	GPS Setup	View GPS & A-GPS SUPL information.
	HAC Settings	Enable or disable the Hearing Aid Compatibility (HAC) feature. See Chapter 5, Using the Phone for more information. MC9596 and MC9598 only.
	IST Settings	Set the appropriate setting for configuring the device's Interactive Sensor Technology. See
	Keylight	Set the keypad backlight time-out. Refer to the <i>Microsoft Applications for Windows Mobile 6 User Guide</i> for more information.

Table 3-7 Settings in the Setting Window (Continued)

Icon	Name	Description
	Managed Programs	Lists applications that have been installed remotely by your system administrator. Refer to the <i>Microsoft Applications for Windows Mobile 6 User Guide</i> for more information.
	Memory	Check the device memory allocation status and memory card information. Refer to the <i>Microsoft Applications for Windows Mobile 6 User Guide</i> for more information.
	Phone Info	Displays the phone version information. MC9596 and MC9598 only.
	Power	Check battery power and set the time-out for turning off the display to conserve battery power. Refer to the <i>Microsoft Applications for Windows Mobile 6 User Guide</i> for more information.
	Regional Settings	Set the regional configuration to use, including the format for displaying numbers, currency, date, and time on the MC9500-K. Refer to the <i>Microsoft Applications for Windows Mobile 6 User Guide</i> for more information.
	Remove Programs	Remove programs that you installed on the MC9500-K. Refer to the <i>Microsoft Applications for Windows Mobile 6 User Guide</i> for more information.
	Screen	Change the screen orientation, re-calibrate the screen, and change the screen text size. Refer to the <i>Microsoft Applications for Windows Mobile 6 User Guide</i> for more information.
	System Info	Displays the MC9500-K's software and hardware information. Refer to the <i>Microsoft Applications for Windows Mobile 6 User Guide</i> for more information.
	Task Manager	Enables viewing of memory and CPU allocations and stops running processes. Refer to the <i>Microsoft Applications for Windows Mobile 6 User Guide</i> for more information.
	Windows Update	Link to Microsoft's web site and update Windows Mobile® on your device with the latest security patches or fixes. Do not use. Obtain updates from Motorola. Refer to the <i>Microsoft Applications for Windows Mobile 6 User Guide</i> for more information.

Connections Tab







	Beam	Set the device to receive incoming IrDA beams.
	Bluetooth	Enables Bluetooth radio and functionality. See
	Connections	Set up one or more types of modem connections for your device, such as phone dial-up, GPRS, Bluetooth, and more, so that your device can connect to the Internet or a private local network.

Table 3-7 Settings in the Setting Window (Continued)

Icon	Name	Description
	Domain Enroll	Make your device an AD domain member for device management and security. Refer to the <i>Microsoft Applications for Windows Mobile 6 User Guide</i> for more information.
	USB to PC	Enables or disables the enhanced network connectivity. Refer to the <i>Microsoft Applications for Windows Mobile 6 User Guide</i> for more information.
	Wi-Fi	Setup wireless network connection and customize settings. Refer to the <i>Microsoft Applications for Windows Mobile 6 User Guide</i> for more information.
	Wireless Manager	Enables or disables the MC9500-K's wireless radios and customizes Wi-Fi and Bluetooth and Phone settings.

Adjusting Volume

To adjust the system volume using the **Speaker** icon in the navigation bar:

1. Tap the **Speaker** icon. The **Volume** dialog box appears.

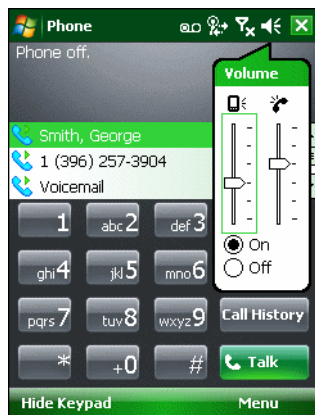
**Figure 3-12** Volume Dialog Box

2. Tap and move the slide bar to adjust the volume.
3. Select the **On** or **Off** radio button to turn the volume on or off.

You can also adjust the system volume using the **Sounds & Notifications** window, or use the **Up/Down** button on the side of the MC9500-K.

Battery Status Indications

Battery icons appear on the navigation bar indicating the battery power level. When the main battery power falls below a predetermined level the icon indicates the status and a battery dialog box appears indicating the status of the battery.

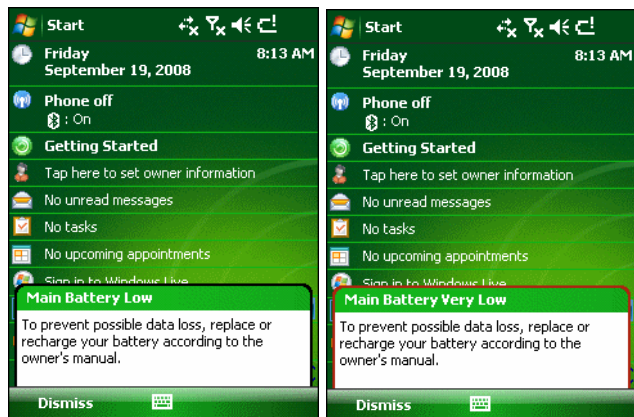

Figure 3-13 Battery Status Dialog Box

The **Battery** icon always appears in the **navigation bar** when the Today screen is visible. The icon indicates the battery power level. The message displays until the **Dismiss** button is pressed.



Figure 3-14 Battery Icon on the Title Bar

Also view the battery status using the **Power** window. Either:

- Tap the **Battery** icon
- Tap **Start** > **Settings** > **System** tab > **Power** icon.

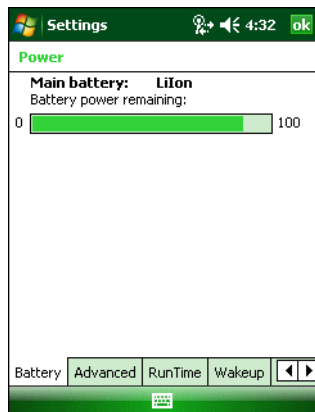

Figure 3-15 Settings Power Window

Battery Reserve Options

If the charge of the battery reaches a critical threshold, the MC9500-K shuts down. This threshold can be changed but affects the amount of time that data can be retained.

1. Tap **Start** > **Settings** > **System** tab > **Power** icon > **RunTime** tab. A warning message appears.

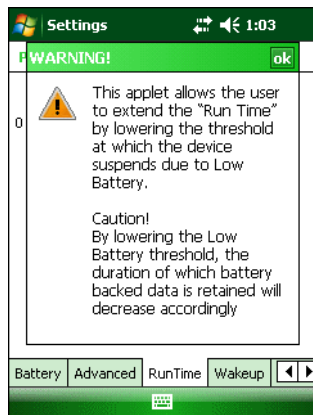

Figure 3-16 Warning Message

2. Read the warning message and tap **ok**.

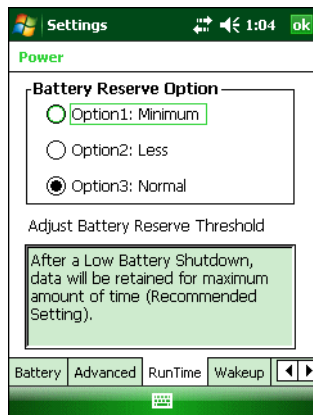

Figure 3-17 RunTime Tab

3. Select one of the **Battery Reserve Options**.
 - **Option 1: Minimum** - After a low battery shutdown, data will be retained for minimum amount of time. Battery should be replaced immediately to avoid data loss.
 - **Option 2: Less** - After a low battery shutdown, data will be retained for less than normal amount of time.
 - **Option 3: Normal** - After a low battery shutdown, data will be retained for maximum amount of time.
4. Tap **ok**.

Main Battery Temperature Notifications

The temperature notification system implements three levels of notification when the temperature within the battery exceeds specific temperature thresholds:

- **Level 1: Temperature Watch**; this level is similar to main battery low warning. It indicates that the battery temperature has reached the first threshold level. The user should move to an environment within proper operating temperature.
- **Level 2: Temperature Warning**; this level is similar to main battery very low warning. It indicates the battery temperature has reached the second threshold level. The user should stop using the MC9500-K.

- **Level 3: Temperature Error**; this level indicates the battery has reached an unusable temperature threshold and immediately suspends the MC9500-K. This level does not have any graphical notification associated with it.



Figure 3-18 Main Battery Temperature Watch Dialog Box



Figure 3-19 Main Battery Temperature Warning Dialog Box



NOTE The **Temperature Warning** dialog box remains visible until you tap **Hide**.

Using Voice-Over-IP

The MC9500-K supports Voice over IP over WLAN (VoWLAN) using Motorola or third party voice clients. The MC9500-K can communicate using VoIP either using the MC9500-K supports several audio outputs, including back speaker phone, front receiver or handset, and Bluetooth headset.

It is recommended that the wireless network use the 802.11a (5 GHz) band for voice applications. Using the 5 GHz band avoids some noise sources that may occur on the 802.11b/g (2.4 GHz) band due to wireless interference.

When using a Bluetooth headset with the MC9500-K and VoWLAN, it is required to use the Bluetooth Headset profile instead of Hands-free profile. Use the buttons on the MC9500-K to answer and end calls. See [Chapter 7, Using Bluetooth](#) for information on setting up a Bluetooth Headset Profile.

Infrared Connection

Using infrared, you can enable short-range file exchange between your MC9500-K and another IrDA device.

Exchanging Files using IR Connection

Ensure that the IrDA function on both the MC9500-K and the other device are enabled.

To send files via IrDA connection:

1. Switch to the program where you created the item you want to send and locate the item in the list.

✓ **NOTE** Do not cover or block the IrDA window.

2. Align the IrDA port of the MC9500-K with that of the IrDA device so that they are unobstructed and within a close range.



Figure 3-20 *Align MC9500-K with IrDA Device*

3. Tap and hold the item, then tap Beam [type of item] on the pop-up menu.
4. Tap the device that you want to send the file to.

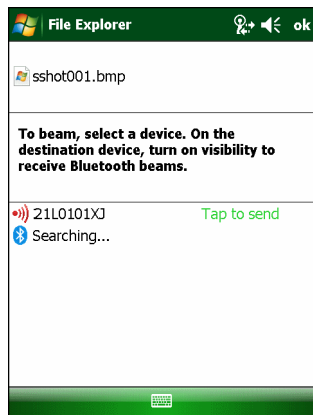

Figure 3-21 *Beam File*

To receive files via IrDA connection:

1. Align the IrDA port of the MC9500-K with that of the other IrDA device so that they are unobstructed and within a close range.
2. On the other device, send the file to the MC9500-K.

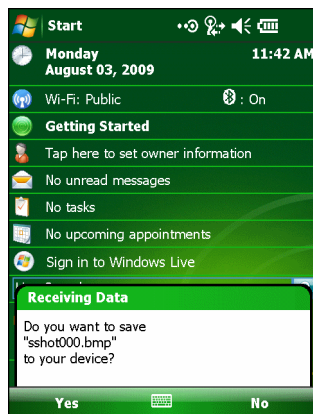

Figure 3-22 *Receive File*

3. When the **Receiving Data** dialog displays, tap **Yes**.

Printing

The MC9500-K supports printing to specific devices. The Motorola Print Manager, available from the Support Central web site, provides support for printing to Bluetooth enabled printers.

Chapter 4 Data Capture

Introduction

The MC9500-K offers three types of data capture options:

- Laser scanning
- Imaging
- Color digital camera.

✓ **NOTE** To read a bar code, a scanning enabled application must be installed on the MC9500-K. A sample scanning application can be downloaded from the Motorola Support Central site at <http://www.motorola.com/enterprisemobility/support>.

Laser Scanning

An MC9500-K with an integrated linear laser scanner has the following features:

- Reading of a variety of bar code symbologies, including the most popular 1-D code types.
- Intuitive aiming for easy point-and-shoot operation.

Scanning Considerations

Typically, scanning is a simple matter of aim, scan, and decode and a few quick trial efforts master it. However, consider the following to optimize scanning performance:

- Range
Any scanning device decodes well over a particular working range — minimum and maximum distances from the bar code. This range varies according to bar code density and scanning device optics.
Scanning within range brings quick and dependable decodes; scanning too close or too far away prevents decodes. Move the scanner closer or further away to find the right working range for the bar codes being scanned.

- Angle
Scanning angle is important for promoting quick decodes.
The MC9500-K scans at a 15° angle which improves scanning ergonomics.
- Hold the MC9500-K farther away for larger symbols.
- Move the MC9500-K closer for symbols with bars that are close together.

✓ **NOTE** Scanning procedures depend on the application and MC9500-K configuration. An application may use different scanning procedures from the one listed above.

Laser Scanning

1. Ensure that a scan enabled application is loaded on the MC9500-K.

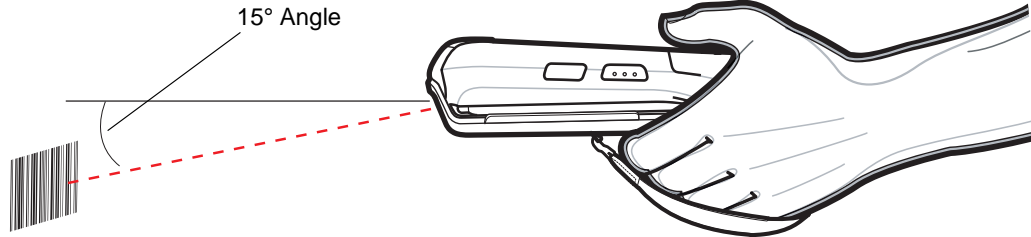

Figure 4-1 Linear Scanning

2. Press and hold the scan button. The laser beam exits from the end of the MC9500-K. Ensure the red scan beam covers the entire bar code. The Decode LED lights red to indicate that scanning is in process, then lights green and a beep sounds, by default, to indicate the bar code was decoded successfully.

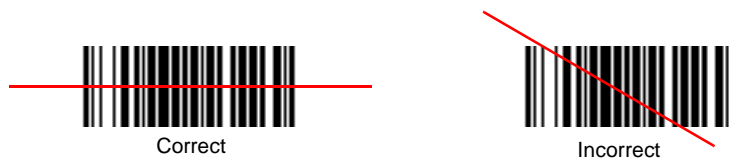
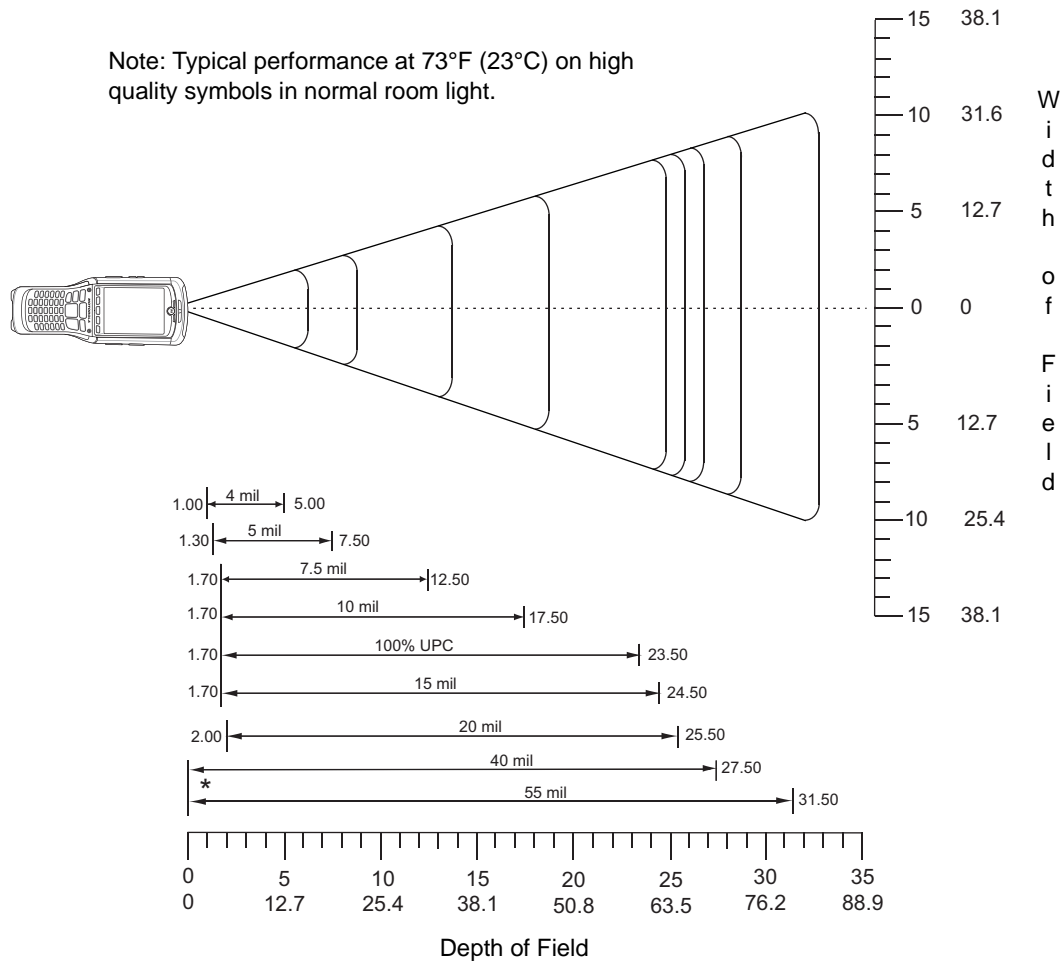

Figure 4-2 Linear Scanner Aiming Pattern

3. Release the scan button.

Decode Zones

The decode zones for the laser scanners are shown in *Figure 4-3* and *Figure 4-4*. The figures shown are typical values. *Table 4-2* lists the typical distances for selected bar code densities. The minimum element width (or “symbol density”) is the width in mils of the narrowest element (bar or space) in the symbol.



* Minimum distance determined by symbol length and scan angle.

Figure 4-3 MC9500-K Laser Scanner 35° Decode Zone

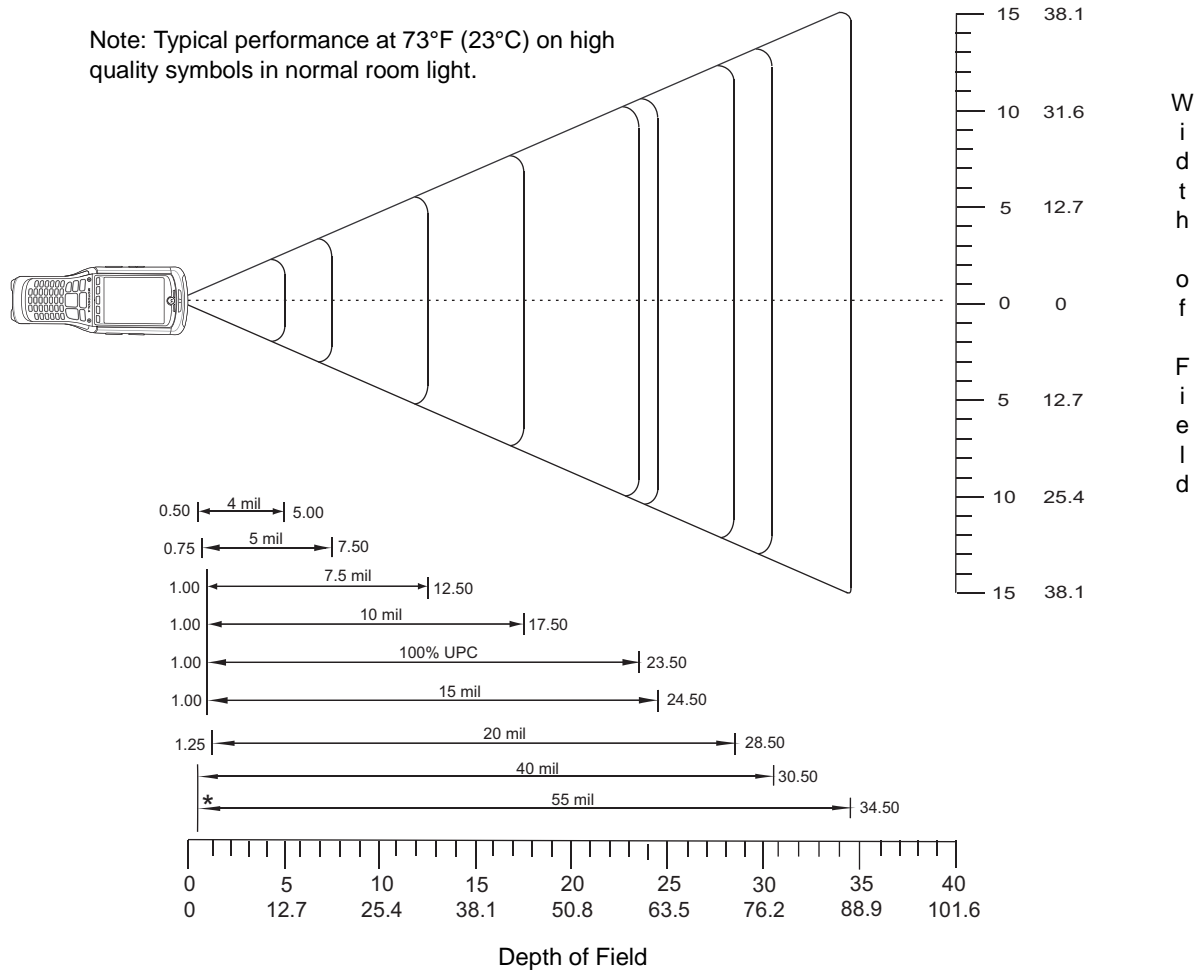

* Minimum distance determined by symbol length and scan angle.

Figure 4-4 MC9500-K Laser Scanner 47° Decode Zone

Table 4-1 Laser Scanner Decode Distances

Symbol Density/ Bar Code Type/ W-N Ratio	Bar Code Content/ Contrast ^{Note 1}	35° Typical Working Ranges		47° Typical Working Ranges	
		Near	Far	Near	Far
4.0 mil Code 39; 2.5:1	ABCDEFGH 80% MRD	1.00 in 3.81 cm	5.00 in 13.97 cm	0.50 in 2.50 cm	5.00 in 13.97 cm
5.0 mil Code 39; 2.5:1	ABCDEFGH 80% MRD	1.30 in 4.57 cm	7.50 in 20.32 cm	0.75 in 3.18 cm	7.50 in 20.32 cm
7.5 mil Code 39; 2.5:1	ABCDEF 80% MRD	1.70 in 5.59 cm	12.50 in 33.02 cm	1.00 in 3.81 cm	12.50 in 33.02 cm
10 mil Code 39; 2.5:1	ABCDE 90% MRD	1.70 in 5.59 cm	17.50 in 45.72 cm	1.00 in 3.81 cm	17.50 in 45.72 cm
13 mil 100% UPC	12345678905 90% MRD	1.70 in 5.59 cm	23.50 in 60.96 cm	1.00 in 3.81 cm	23.50 in 60.96 cm
15 mil Code 39; 2.5:1	ABCD 80% MRD	1.70 in 5.59 cm	27.50 in 71.12 cm	1.00 in 3.81 cm	27.50 in 71.12 cm
20 mil Code 39; 2.2:1	123 80% MRD	2.00 in 6.35 cm	28.50 in 73.66 cm	1.25 in 4.45 cm	32.50 in 83.82 cm
40 mil Code 39; 2.2:1	AB 80% MRD	Note 4	32.50 in 83.82 cm	Note 4	35.50 in 91.44 cm
55 mil Code 39; 2.2:1	CD 80% MRD	Note 4	41.50 in 106.68 cm	Note 4	44.50 in 114.30 cm

Notes:

1. CONTRAST measured as Mean Reflective Difference (MRD) at 650 nm.
2. Near ranges on lower densities (not specified) are largely dependent upon the width of the bar code and the scan angle.
3. Working range specifications at ambient temperature (23°C), Photographic quality symbols. pitch=10°, roll=0°, skew=0°, ambient light < 150 ft.-candles.
4. Dependent on width of bar code.
5. Distances measured from front edge of device.

Imaging

MC9500-K with an integrated imager have the following features:

- Omnidirectional (360°) reading of a variety of bar code symbologies, including the most popular linear, postal, PDF417, and 2D matrix code types.
- The ability to capture and download images to a host for a variety of imaging applications.
- Advanced intuitive laser aiming for easy point-and-shoot operation.

The imager uses digital camera technology to take a digital picture of a bar code, stores the resulting image in its memory, and executes state-of-the-art software decoding algorithms to extract the data from the image.

Operational Modes

MC9500-K with an integrated imager support three modes of operation, listed below. Activate each mode pressing the **Scan** button.

- **Decode Mode:** In this mode, the MC9500-K attempts to locate and decode enabled bar codes within its field of view. The imager remains in this mode as long as you hold the scan button, or until it decodes a bar code.

✓ **NOTE** To enable Pick List Mode, download the Control Panel applet from the Support Central web site at <http://www.motorola.com/enterprisemobility/support>. Pick List can also be set in an application using a API command.

- **Pick List Mode:** This mode allows you to selectively decode a bar code when more than one bar code is in the MC9500-K's field of view. To accomplish this, move the aiming crosshair center dot over the required bar code to decode only that bar code. This feature is ideal for pick lists containing multiple bar codes and manufacturing or transport labels containing more than one bar code type (either 1D or 2D).
- **Image Capture Mode:** Use this mode to capture an image within the MC9500-K's field of view. This is useful for capturing signatures or images of items like damaged boxes.

Imager Scanning

1. Ensure that a scan-enabled application is loaded on the MC9500-K.

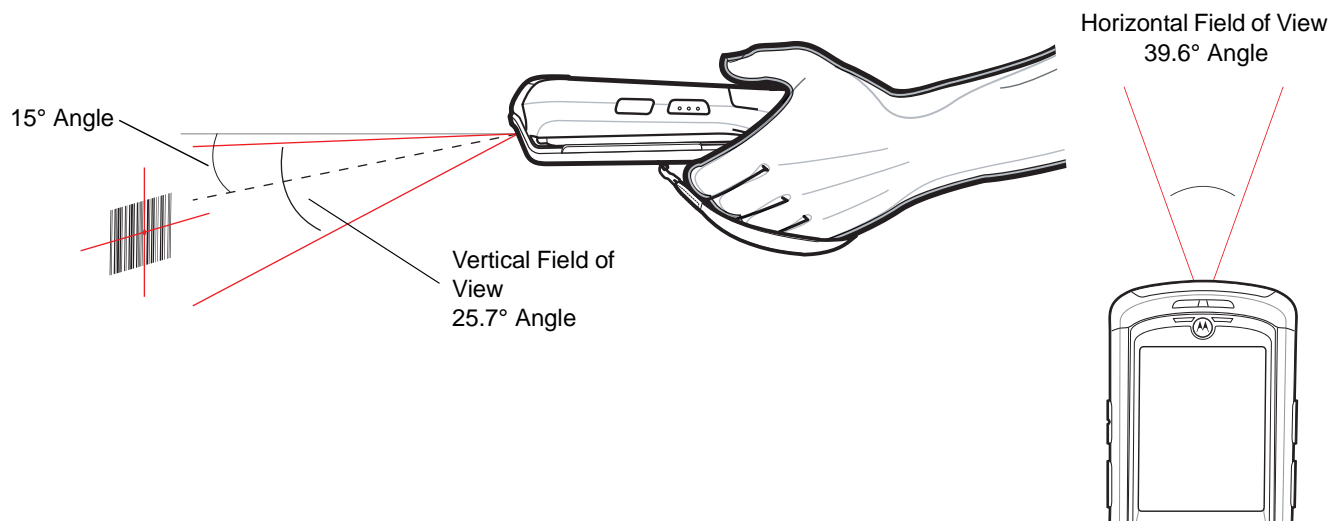

Figure 4-5 Image Capture Field of View

2. Press and hold the scan button.

The red laser aiming pattern turns on to assist in aiming. Ensure the cross-hair is on top of the bar code.

The Decode LED lights red to indicate that scanning is in process, then lights green and a beep sounds, by default, to indicate the bar code was decoded successfully. Note that when the MC9500-K is in Pick List Mode, the imager does not decode the bar code until the crosshair center dot touches the bar code.

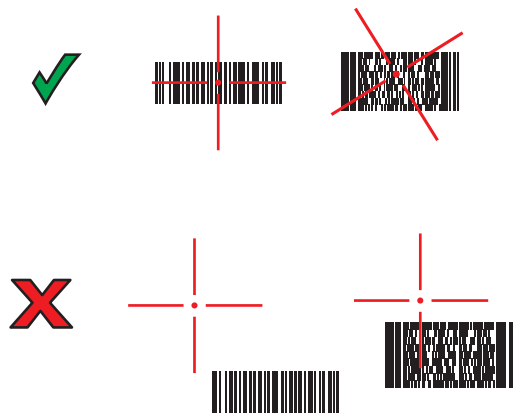

Figure 4-6 *Imager Aiming Pattern*



Figure 4-7 *Pick List Mode with Multiple Bar Codes*

3. Release the scan button.

- ✓ **NOTE** Imager decoding usually occurs instantaneously. The MC9500-K repeats the steps required to take a digital picture (image) of a poor or difficult bar code as long as the scan button remains pressed.

Imager Decode Ranges

The decode ranges provide the decode distances for bar codes of specified densities. *Figure 4-8* shows the imager decode ranges and *Table 4-2 on page 4-9* lists the scan ranges for the selected bar code densities. The minimum element width (or “symbol density”) is the width in mils of the narrowest element (bar or space) in the symbol. The maximum usable length of a symbol at any given range is shown below.

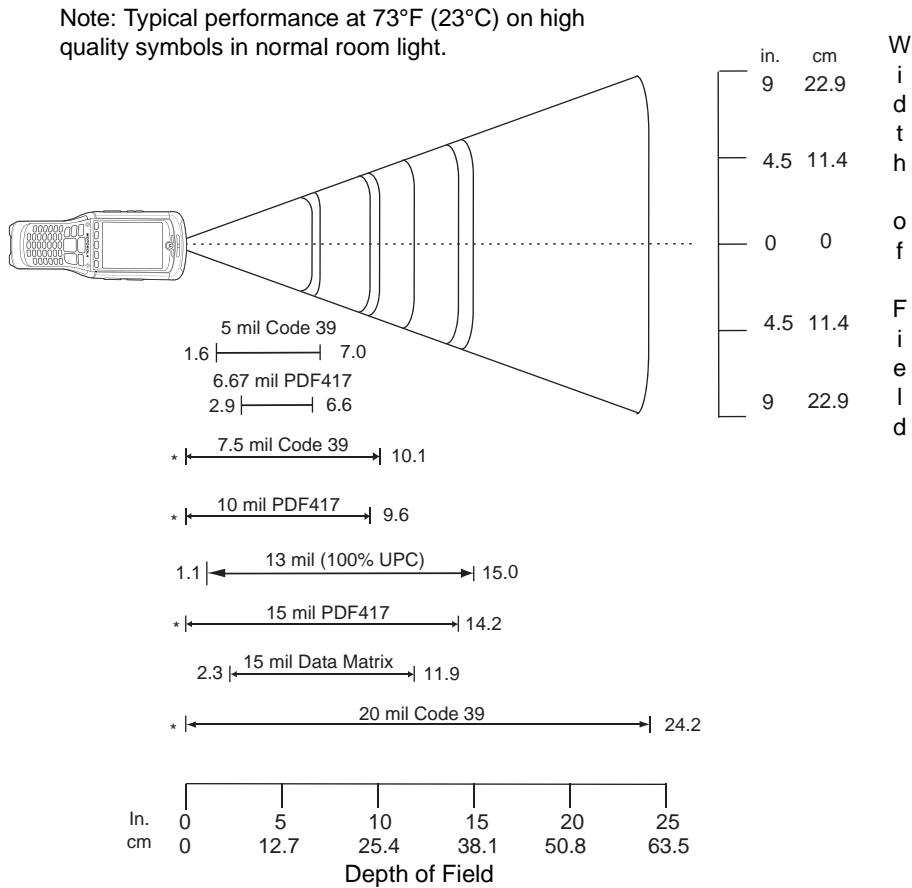

* Minimum distance determined by symbol length and scan angle.

Figure 4-8 MC9500-K Imager Decode Ranges

Table 4-2 MC9500-K Imager Decode Distances

Symbol Density/ Bar Code Type	Bar Code Content/ Contrast ^{Note 2}	Typical Working Ranges	
		Near	Far
5.0 mil Code 39	ABCDEFGH 80% MRD	1.6 in 4.06 cm	7.0 in 17.78 cm
6.67 mil PDF417	4 Col, 20 Rows 80% MRD	2.9 in 7.37 cm	6.6 in 16.76 cm
7.5 mil Code 39	ABCDEF 80% MRD	Note 1	10.1 in 25.65 cm
10 mil PDF417	3 Col, 17 Rows 80% MRD	Note 1	9.6 in 24.38 cm
13 mil UPC-A	012345678905 80% MRD	1.1 in 2.79 cm	15.0 in 38.10 cm
15 mil PDF417	80% MRD	Note 1	14.2 in 36.07 cm
15 mil Data Matrix	18 x 18 Modules 80% MRD	2.3 in 5.84 cm	11.9 in 30.23 cm
20 mil Code 39	123 80% MRD	Note 1	24.2 in 61.47 cm

1. Near distances are field-of-view (FOV) limited.

2. Contrast is measured as Mean Reflective Difference (MRD) at 670 nm.

3. Working range specifications at temperature = 23°C, pitch=18°, roll=0°, skew=0°, photographic quality, ambient light ~30 ft.-c, humidity 45-70% RH.

Color Digital Camera

MC9500-K with an integrated color digital camera have the following features:

- Photo capture
- Video capture
- Omnidirectional reading of a variety of bar code symbologies, including the most popular linear, postal, PDF417, and 2D matrix code types.
- Advanced intuitive aiming for easy point-and-shoot operation.

Digital Camera Scanning

The camera uses digital camera technology to take a digital picture of a bar code, stores the resulting image in its memory, and executes state-of-the-art software decoding algorithms to extract the data from the image.

1. Ensure that a scan-enabled application is loaded on the MC9500-K.

2. Aim the camera lens on the back of the MC9500-K at a bar code.
3. Press and hold the scan button. A preview window appears on the display window with a red aiming reticle in the center. The Decode LED lights red to indicate that scanning is in process.

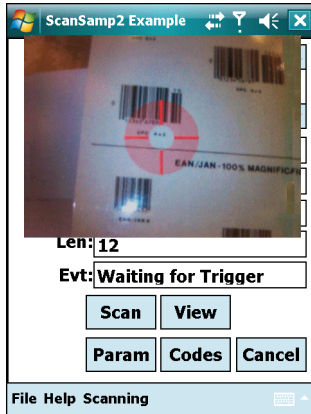

Figure 4-9 Sample Scan Application with Preview Window

4. Move the MC9500-K until the red aiming reticle is over the bar code to scan.
5. The Decode LED lights green and a beep sounds, by default, to indicate the bar code was decoded successfully.

- ✓ **NOTE** The camera decode feature is set by default to automatically decode the bar code when read. This feature can be programmed to display a green aiming reticle upon good decode indicating that the bar code has been successfully decoded and to that the scan button may be released.

Taking Photos

- ✓ **NOTE** Ensure that the scanning/imaging application is disabled prior to enabling the camera.

To take a photo:

1. Tap **Start > Programs > Pictures & Videos** icon.
2. Tap **Camera** on the command bar.
3. Check the image on the view finder, adjust if necessary.
4. Press the **Enter** key to take the picture. Hold the MC9500-K still until the shutter sound is heard.

Recording Video

- ✓ **NOTE** Ensure that the scanning/imaging application is disabled prior to enabling the camera.

To record a video clip:

1. Tap **Start > Programs > Pictures & Videos** icon.
2. Tap **Camera** on the command bar.
3. Tap **Menu > Video** to set shooting mode to video.
The available recording time displays on the screen.



NOTE By default, the time limit for recording videos is set to 30 seconds.

4. Press the **Enter** key to begin recording.
Recording stops when you press the **Enter** button again.

Viewing Photos and Videos

To view photos and video clips:

1. Tap **Start > Programs > Pictures & Videos** icon.
2. Tap the picture or video clip to view.

Chapter 5 Using the Phone

Introduction

Use the MC9596 and MC9598 to make phone calls, set up speed dials, keep track of calls, and send text messages. Your wireless service provider may also provide other services such as voice mail, call forwarding, and caller ID.

Also use the integrated phone to connect to an ISP or work network in order to browse the Web and read e-mail. Connect to the Internet or work network over High-Speed Downlink Packet Access (HSDPA) (MC9596) or Evolution Data-Optimized (EvDO) (MC9598) using Cellular Line, or using the modem specified by the mobile operator. For more information, or to customize the MC9500-K phone by changing phone settings, see the *MC9500-K Mobile Computer Integrator Guide*.

Accessing the Phone Keypad

✓ **NOTE** Keypads vary depending on services and the state of the phone.

Access the keypad regardless of the program in use. Applications on the MC9500-K can be in use during a call.

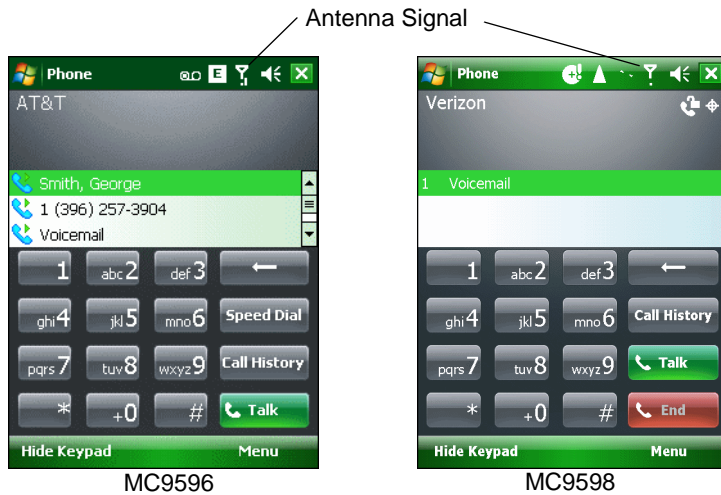

Figure 5-1 Phone Keypads

To access the phone keypad tap **Start > Phone**, press the F1 key or press the green key.

To receive calls when the MC9500-K is suspended, leave the phone radio turned on and ensure the MC9500-K is set to wake with any key.

Turning the Phone On and Off

Windows Mobile 6.1 devices include **Wireless Manager**, which provides a simple method of enabling and disabling the phone.

To open **Wireless Manager**, tap the **Connectivity** icon.

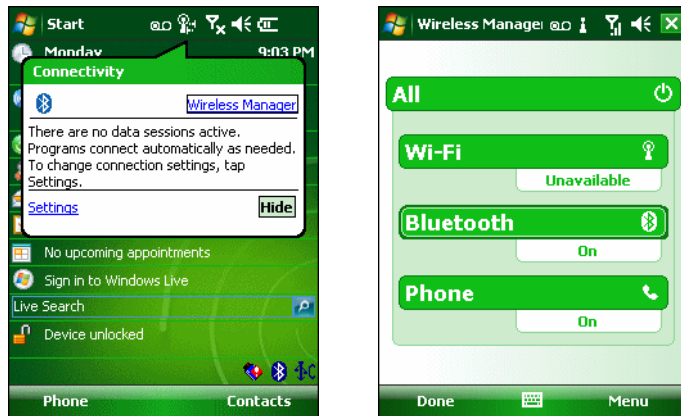

Figure 5-2 Opening Wireless Manager

Select **Wireless Manager**. The **Wireless Manager** window appears.

To toggle on or off the phone, tap **Phone** bar.

To configure settings for a connection, tap **Menu > Phone Settings**.

✓ **NOTE** To receive calls when your device is suspended, leave the phone turned on.

Audio Modes

The MC9500-K offers three audio modes for use during phone calls:

- **Handset Mode:** Switches audio to the speaker at the top front of the MC9500-K, so you can use the MC9500-K as a handset. This is the default mode.
- **Speaker Mode:** Use the MC9500-K as if on speaker phone. Tap the **Speaker On** button to activate this mode. Tap the **Speaker Off** button to switch back to handset mode.
- **Headset Mode:** Connect a Bluetooth headset or a wired headset to automatically switch audio to the headset.

The MC9500-K defaults to handset mode. When a wired headset is plugged into the MC9500-K headset connector or a Bluetooth headset is configured for use with the MC9500-K, the earpiece and speakerphone are muted and audio is heard through the headset.

✓ **NOTE** While using a Bluetooth headset during a call, the mobile computer will not go into suspend mode.



Handset Mode



Speaker Mode

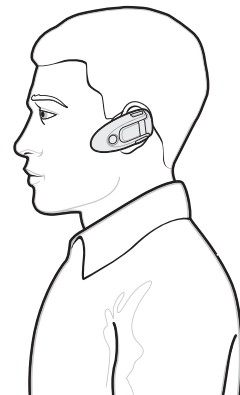

Headset Mode

Figure 5-3 Audio Modes

Using a Wired Headset

✓ **NOTE** Remove the headset jack plug before connecting the Headset Adapter to the MC9500-K.

You can use a stereo headset for audio communication when using an audio-enabled application. To use a headset, plug the headset jack of the Headset Adapter Cable into the headset connector on the side of the MC9500-K. Plug the Headset connector into the connector on the Headset Adapter Cable. Set the MC9500-K's volume appropriately before putting the headset on. Plugging a headset into the jack mutes the speaker.

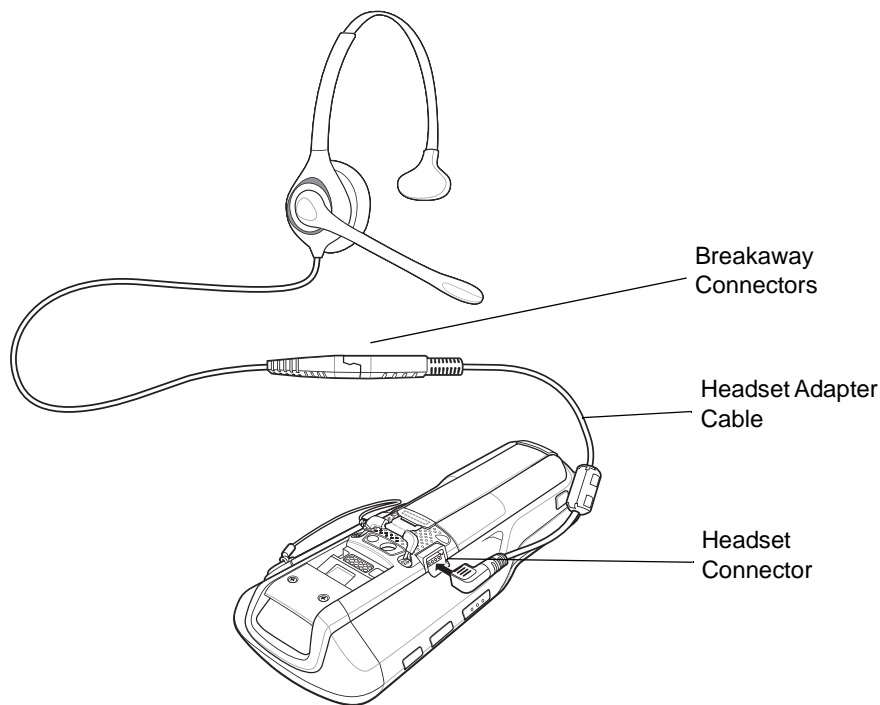

Figure 5-4 *Using a Headset*

Using a Bluetooth Headset

You can use a Bluetooth headset for audio communication when using an audio-enabled application. See [Chapter 7, Using Bluetooth](#) for information on connecting a Bluetooth headset to the MC9500-K. Set the MC9500-K's volume appropriately before putting the headset on. When a Bluetooth headset is connected the speakerphone is muted.

It is recommended for phone conversations to use the Bluetooth Hands-free profile instead of the Headset profile. See [Chapter 7, Using Bluetooth](#) for more information.

- ✓ **NOTE** When using a Bluetooth headset, during a call, the MC9500-K power button is disabled and the MC9500-K will not go into suspend mode. Once the call is completed, the power button functionality is enabled.

The following dialog box displays when a Bluetooth headset connection is established and the power button is pressed.



Figure 5-5 WWAN Bluetooth Audio Notification Dialog Box

Adjusting Audio Volume

Use the Volume Control Slider or the keypad keys to adjust the volume of the ringer when not in a call and the audio volume when in a call.

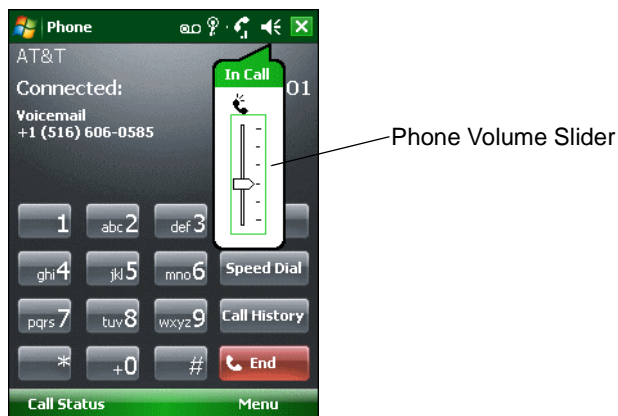

Figure 5-6 Phone Volume Slider

To adjust the volume tap the **Speaker** icon in the **Title** bar. Move the slider up or down to adjust the volume.

✓ **NOTE** Adjust the conversation phone volume during a call. Adjusting the volume while not in a call affects the ring and notification sound levels.

Hearing Aid Compatibility Setting

To set the Hearing Aid Compatibility (HAC) setting:

Tap **Start > Settings > System > HAC Settings** icon. The **HAC Settings** window appears.

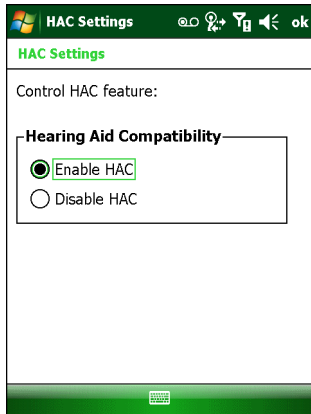

Figure 5-7 HAC Settings Window

To enable the HAC feature, tap the **Enable HAC** radio button.

To disable the HAC feature, tap the **Disable HAC** radio button.

Making a Call

- ✓ **NOTE** You can make emergency calls even when the MC9500-K is locked or when a SIM card is not installed. See [Making an Emergency Call on page 5-9](#) for more information.

With the MC9500-K, you can make a call from the phone, contacts, speed dial and call history.

Using the Phone

To make a call using the phone keypad:

1. Tap **Start > Phone** or press the green key.
2. From the **Phone** keypad, tap the number to call.
3. Tap **Talk**.
4. Tap **End** to stop dialing or end the call.

- ✓ **NOTE** Alternatively, use the green and red keys on the MC9500-K function key to dial (green) and end (red) calls.

If you tap a wrong number, tap Delete key to erase each subsequent digit of a number. To erase the entire number, tap and hold the Delete key.

Using Contacts

Use Contacts to make a call without looking up or entering the phone number.

To make a call from Contacts:

1. Tap **Start > Contacts**.
2. From the contact list, tap and hold the contact name.

3. Tap **Call Work**, **Call Home** or **Call Mobile**.

- ✓ **NOTE** To make a call from an open contact, tap the number to call. See On-Device Help for more information about Contacts.

Creating an Outlook Contact

- ✓ **NOTE** When entering a contact phone number that contains a star (*) character followed by a plus (+) character, save the contact as an Outlook Contact. Do not save the contact to a SIM card.

To create an Outlook contact:

1. Tap **Start > Contacts**.
2. Tap **New**.
3. If the Phone is on the **Select Contact Type** window displays. Select **Outlook Contact**.

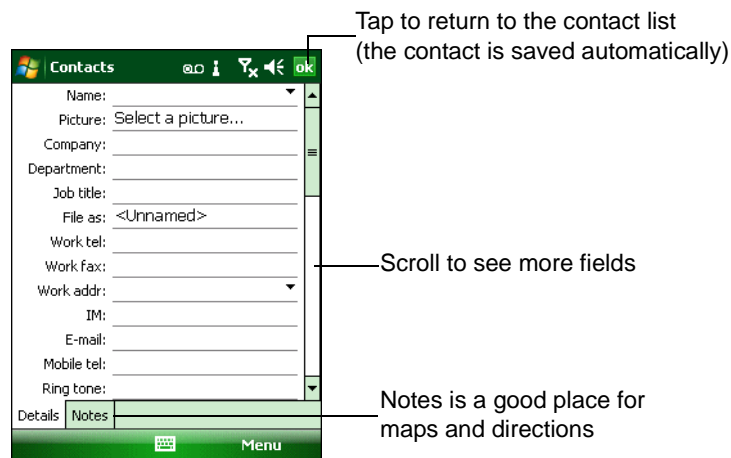

Figure 5-8 *Creating a Contact*

4. Using the input panel, tap in each field and enter contact information as needed. Scroll down to see all fields.
5. Tap the arrow next to the **Name:** or **Home addr:** field to open a window for adding more details.
6. To assign the contact to a category, tap **Categories**.
7. To select one or more categories for the contact, select their check boxes. This allows displaying contacts by category in the contact list.
8. Tap **New** to add a category.
9. Enter the name for the category in the text box, and tap **ok**.
10. Tap **ok**.
11. To add notes, tap the **Notes** tab and enter text, draw, or create a recording.
12. When finished, tap **ok** to return to the contact list.

Editing an Outlook Contact

To make changes to a contact:

1. Tap **Start > Contacts**.

2. Tap the contact in the contact list to open it.
3. Tap **Menu > Edit** and make the changes.
4. Tap **ok**.

Deleting a Contact

To delete a contact:

1. Tap **Start > Contacts**.
2. Tap and hold the contact in the contact list and select **Delete Contact** from the pop-up menu, or select the contact and tap **Menu > Delete Contact**.

Creating a SIM Contact

To create a SIM contact:

✓ **NOTE** When entering a contact phone number that contains a star (*) character followed by a plus (+) character, save the contact as an Outlook Contact. Do not save the contact to a SIM card.

1. Tap **Start > Contacts**.
2. Tap **New**.
3. Select **SIM Contact**.

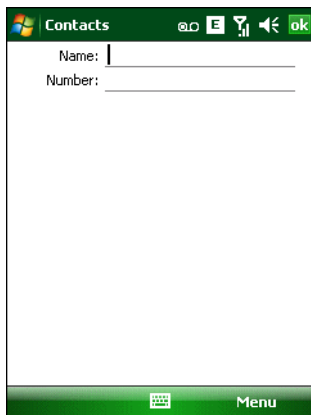

Figure 5-9 *Creating a SIM Contact*

4. Using the input panel, tap in each field and enter contact information.
5. When finished, tap **ok** to return to the contact list.

Using Call History

To make a call using Call History:

1. Tap **Start > Phone** or press the green key.
2. From the Phone keypad, tap **Call History**.

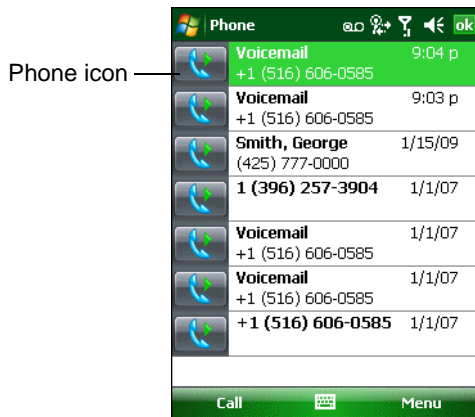

Figure 5-10 Call History

3. Tap the phone icon next to the number to begin dialing and return to the phone keypad.
4. Tap **End** or press the red key to stop dialing or end the call.

Making a Speed Dial Call

Use Speed Dial to call someone saved in the speed dial directory.

To make a speed dial call:

1. Tap **Start > Phone** or press the green key.
2. From the Phone keypad, tap and hold the speed dial location number assigned to a contact. (To dial a one-digit speed dial location number, tap and hold the speed dial number. To dial a two-digit speed dial location number, tap the first digit and then tap and hold the second digit.)

or

From the Phone keypad, tap **Speed Dial** and tap the speed dial location number of the desired contact in the list.

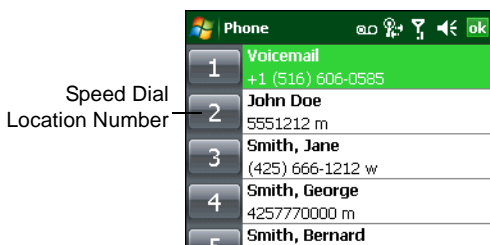

Figure 5-11 Speed Dial Contact List

3. To stop dialing or end the call, tap **End** or press the red key.

Making an Emergency Call

Your service provider programs one or more emergency phone numbers, such as 911 or 999, that you can call under any circumstances, even when your phone is locked or the SIM card is not inserted. Your service provider can program additional emergency numbers into your SIM card. However, your SIM card must be inserted in your phone in order to use the numbers stored on it. See your service provider for additional information.

When the alpha primary keypad is locked, press the Orange key twice to set the keypad to numeric mode and then enter the emergency number.

- ✓ **NOTE** Emergency numbers vary by country. Your phone's pre-programmed emergency number(s) may not work in all locations, and sometimes an emergency call cannot be placed due to network, environmental, or interference issues.

Answering a Call

A dialog box appears on the MC9500-K when it receives an incoming call. If the phone is set to ring, a ring tone sounds. Answer or ignore the incoming call.

To answer an incoming call tap **Answer** on the **Phone > Incoming...** dialog or press the green key.



Figure 5-12 Incoming Call

To ignore the incoming call tap **Ignore**. This may send the caller to voice mail, depending on the service provider. Otherwise, this presents **Busy** to the calling party.

To end the call tap **End** or press the red key.

Incoming Call Features

- If you receive a call while in a call, tap **Wait** to place the call in call waiting.
- You can use other programs on the MC9500-K during a call. To switch back to Phone, tap **Talk** or tap **Start > Phone**. Tap **End** to end the call.
- If a caller isn't in your contact list, create a contact during the call or from Call History by tapping **Menu > Save to Contacts**.
- To terminate a call when a second call comes in and answer the waiting call, tap **End** on the Phone keypad to disconnect the active call, then tap **Answer** or press the **Send** key to answer the waiting call.
- To hold the current call and answer a waiting call, tap **Answer** or press the **Send** key to place the current call on hold and answer the incoming call.
- To put a call on hold to call another number or answer an incoming call, tap **Hold**. To move from one call to another, tap **Swap**.

Smart Dialing

Smart Dialing makes it easy to dial a phone number. When you start entering numbers or characters, Smart Dialing automatically searches and sorts the contact entries on the SIM card, in Contacts, and the phone numbers in Call History (including incoming, outgoing, and missed calls). You can then select the desired number or contact from the filtered list to dial.

Open the Phone screen, then tap the keys on the Phone keypad that correspond to the phone number or contact to call. The contact panel lists contacts that match the sequence that you entered.

Smart Dialing starts looking for numbers or contacts that match the sequence entered.

To find a phone number:

- Enter the first one or two digits to find a phone number in Call History.
- Enter the first three digits or more to find a phone number from the saved Contacts and SIM card.

To find a contact name:

- Enter the first letter of a contact's first name or last name. Smart Dialing searches for the letter starting from the first character of a contact name as well as from the character that appears after a space, dash, or underscore in a contact name. For example, if you tap number "2" which is associated with [a, b, c] on the Phone keypad, contact names such as the following will be considered matches: "Smith, Bernard", "Adams, John", "Carlson, Eileen", "Dillon, Albert", "Childs, Larry", "Cooper, Robert" and "Parks, Celine".
- If the matching list is long narrow down the search further by entering another letter. Using the same example above, tap "3" which is associated with (d, e, f), the matching list is narrowed down to the following names: "Smith, Bernard", "Adams, John", and "Parks, Celine".

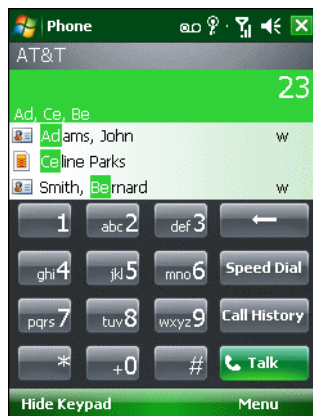

Figure 5-13 Finding a Contact

To make a call or send a text message using Smart Dialing:

1. Begin entering the first few numbers or characters.
2. In the Smart Dialing panel, use the up and down arrows on the keypad to navigate to the desired contact or phone number.
3. When the correct contact is selected, press **TALK** to make a voice call.
4. To send a text message to the selected contact, tap **Menu > Send Text Message**.
5. To call a different phone number associated with the selected contact, tap the contact name and select the phone number to call.

Muting a Call

During a call, you can mute the microphone so you can hear the person on the line but he or she cannot hear conversation from the microphone. This is useful when there is conversation or background noise on your end.

To mute or unmute a call:

1. Tap **Start > Phone** or press the green key.
2. Make a call.
3. Tap **Mute** on the display to mute the audio. The **Mute** icon appears.

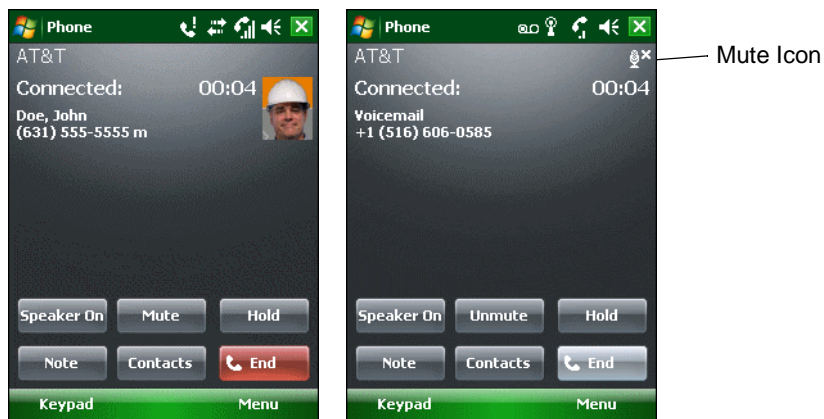

Figure 5-14 Mute Button and Icon

Taking Notes

To create a note during a call, tap **Note** on the display, then enter the note. For more information about creating notes see the Windows On-Device Help.

To access a note created during a call:

1. Tap **Start > Phone** or press the green key.
2. From the Phone keypad, tap **Call History**.
3. Tap and hold the number or the **Note** icon for the phone call entry containing the note.

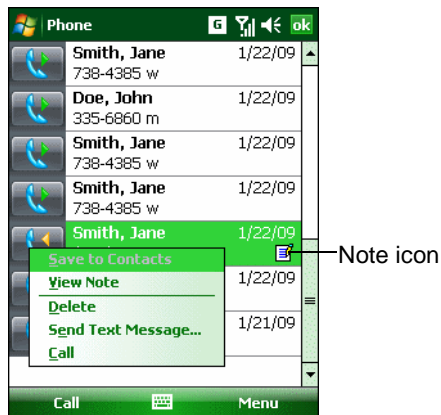

Figure 5-15 Call History - Notes Menu

4. Tap **View Note**.
5. Tap **ok** to exit.

✓ **NOTE** Also access notes directly from the Notes application by tapping **Start > Programs > Notes**.

Using Speed Dial

Create speed dial numbers to dial frequently called numbers with a single tap. Before creating a speed dial entry, ensure the phone number exists in Contacts.

Adding a Speed Dial Entry

To add a speed dial entry from the phone keypad:

1. Ensure the contact and phone number are in the Contacts list.
2. Tap **Start > Phone** or press the green key.
3. Tap **Speed Dial > Menu > New**.

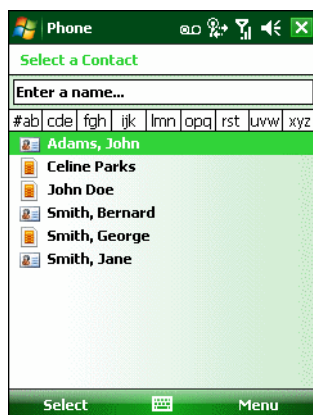

Figure 5-16 Contacts

4. Tap the desired contact name and number in the list.

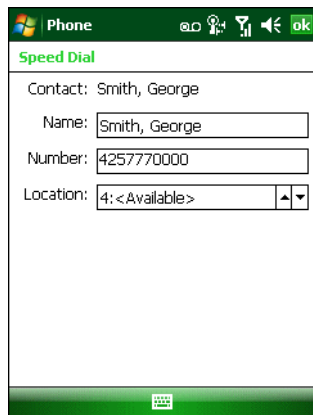

Figure 5-17 Speed Dial Contact Location

5. In the **Location** field, tap the up/down arrows to select an available location to assign as the new speed dial entry. The first speed dial location is reserved for voice mail.
6. Tap **ok** to add the contact to the speed dial list.
7. Tap **ok** to exit the **Speed Dial Contact List**.

To add a speed dial entry from the **Contacts** window:

1. Tap **Start > Contacts**.

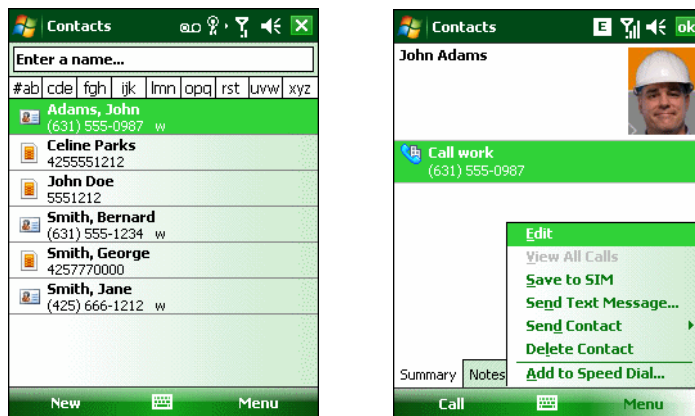

Figure 5-18 Contacts

2. Tap a contact name.
3. Tap **Menu > Add to Speed Dial**.

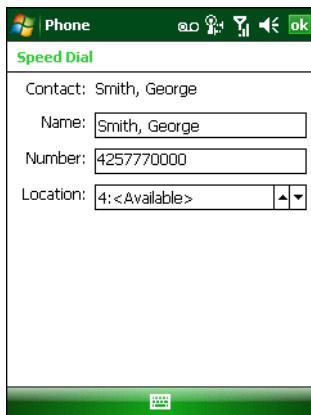

Figure 5-19 Speed Dial Contact Location

4. Tap the up/down arrows to select an available location to assign as the new speed dial entry. The first speed dial location is reserved for voice mail.
5. Tap **ok**.

Editing a Speed Dial Entry

1. Tap **Start > Phone** or press the green key.
2. Tap **Speed Dial**.



Figure 5-20 Speed Dial Contact List

3. Tap and hold the contact name.
4. Tap **Edit...**
5. Change the name, phone number, or location information.
6. Tap **ok**.

✓ **NOTE** Editing names and phone numbers in **Speed Dial** does not alter contact information in **Contacts (Start > Contacts)**.

Deleting a Speed Dial Entry

1. Tap **Start** > **Phone** or press the green key.
2. Tap **Speed Dial**.
3. Tap and hold the contact name.

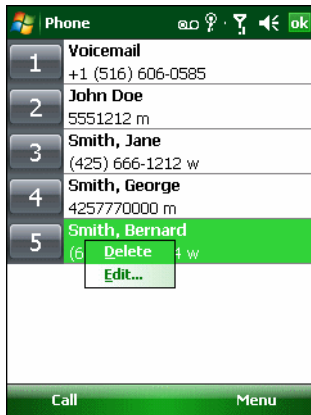

Figure 5-21 Speed Dial Delete Menu

4. Tap **Delete**.
5. Tap **Yes** to confirm permanently deleting the speed dial entry.





NOTE Deleting names and phone numbers in *Speed Dial* does not delete the contact information in **Contacts (Start > Contacts)**.

Using Call History

Use Call History to call someone who was recently called, or recently called in. Call History provides the time and duration of all incoming, outgoing, and missed calls. It also provides a summary of total calls and easy access to notes taken during a call. [Table 4-1](#) lists the call history icons that appear in the **Call History** window.

Table 5-1 Call History Icons

Icon	Description
	This icon appears next to the contact information for all outgoing calls.
	This icon appears next to the contact information for all incoming calls.
	This icon appears next to the contact information for all missed calls.

Managing Call History

Change views, reset the call timer, and delete calls to manage the calls stored in Call History.

Changing the Call History View

1. Tap **Start** > **Phone** or press the green key to display the Phone keypad.
2. From the Phone keypad, tap **Call History**.
3. Tap **Menu** > **Filter** to show the menu.

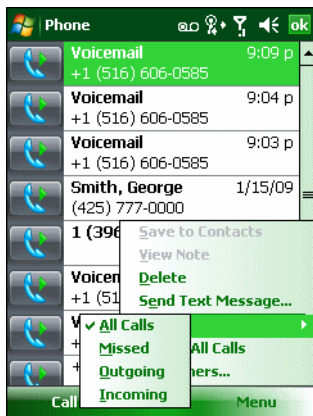

Figure 5-22 Call History - All Calls/Show Menu

4. Select a view type from the menu to display only missed calls, outgoing calls, incoming calls, or calls listed alphabetically by caller name.
5. Tap **ok** to exit the **Call History** window.

Resetting the Recent Calls Counter

1. Tap **Start** > **Phone** or press the green key to display the Phone keypad.
2. From the Phone keypad, tap **Call History**.
3. Tap **Menu**.

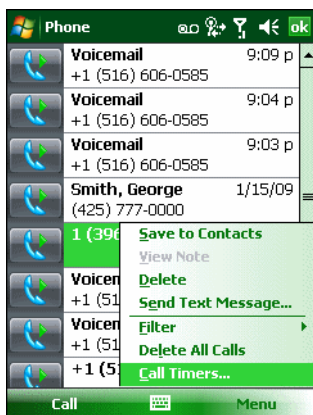

Figure 5-23 Call History - Tools Menu

4. Select **Call Timers...**
5. Tap **Reset**. (The **All Calls**: counter cannot be reset.)
6. Tap **ok** to exit the **Call Timers** window.

Deleting Call History Items by Call Date

1. Tap **Start** > **Phone** or press the green key to display the Phone keypad.
2. From the Phone keypad, tap **Call History**.
3. Tap **Menu** > **Call Timers...** .
4. In the **Delete call history items older than:** drop-down list select a time period on which to base deletion of stored items.
5. Tap **ok** to exit the **Call Timers** window.

Deleting All Call History Items

1. Tap **Start** > **Phone** or press the green key to display the Phone keypad.
2. From the Phone keypad, tap **Call History**.
3. Tap **Menu**.

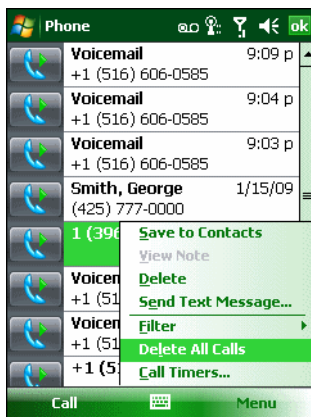

Figure 5-24 Call History - Tools Menu

4. Select **Delete all calls**.

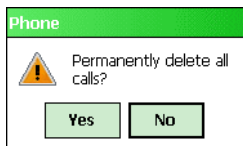

Figure 5-25 Call History - Delete All Dialog

5. Tap **Yes**.
6. Tap **ok** to exit the **Call History** window.

Viewing Call Status

1. Tap **Start** > **Phone** or press the green key to display the Phone keypad.
2. From the Phone keypad, tap **Call History**.
3. Tap an entry. The **Call Status** window appears.

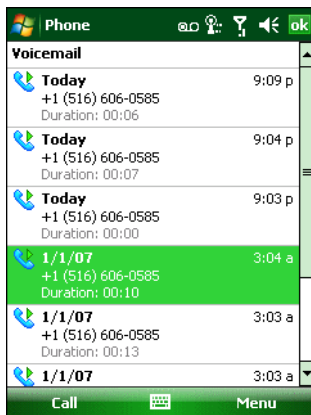

Figure 5-26 Call History - Detail

✓ **NOTE** When more than one call is on the phone line, only the duration of the first call is recorded.

4. Tap **ok** and then **ok** to exit.

Using the Call History Menu

Use the **Call History** menu to dial voice mail, access the Activation Wizard, save to contacts, view a note, delete a listing, send an SMS, and make a call.

1. Tap **Start > Phone** or press the green key to display the Phone keypad.
2. From the Phone keypad, tap **Call History**.
3. Tap and hold an item in the list.

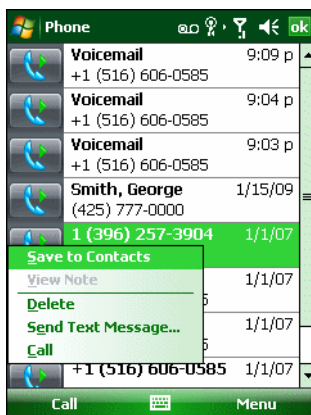

Figure 5-27 Call History - Menu

4. Select an applicable item from the menu, as needed.
5. Depending on the item selected, the appropriate window displays. For example, select **Send Text message** to display the **Text Messages** window.
6. Tap **ok** to exit the **Call History** window.

Swapping Calls on an MC9596

To move between two or more phone calls:

1. Tap **Start** > **Phone** or press the green key to display the Phone keypad.
2. Enter the first phone number and press **Talk**. When the call connects, **Hold** appears on the keypad.



Figure 5-28 *Call Swapping - Hold*

3. Tap **Hold** on to place the first number on hold.
4. Enter the second number and tap **Talk**.



Figure 5-29 *Call Conferencing - Conferencing*

5. Tap **Swap** to move from one call to the other.
6. Tap **End** or press the red key to end each call.

Swapping Calls on an MC9598

To swap between two incoming phone calls:

1. Tap **Answer** to connect to the first call.

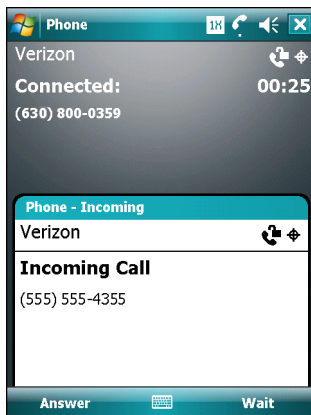

Figure 5-30 Answer a Call

2. When a second call arrives, tap **Answer**. The first call is placed on hold.
3. Tap **Talk** to swap from one call to the other.

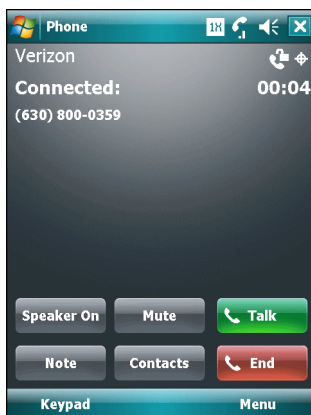

Figure 5-31 Call Swapping

4. Tap **End** or press the red key to end active call. The remaining call re-connects, tap **Answer** to connect to the call.
5. Tap **End** or press the red key to end the last call.

Conference Calling on an MC9596

- ✓ **NOTE** Conference Calling and the number of conference calls allowed may not be available on all services. Please check with your service provider for Conference Calling availability.

To create a conference phone session with multiple people:

1. Tap **Start > Phone** or press the green key to display the Phone keypad.
2. Enter the first phone number and press **Talk**. When the call connects, **Hold** appears on the keypad.



Figure 5-32 Conference Call - Hold

3. Tap **Hold** to place the first call on hold.
4. Enter the second phone number and tap **Talk**.
5. After the call is answered, tap **Menu** > **Conference** to place the calls in conference mode.

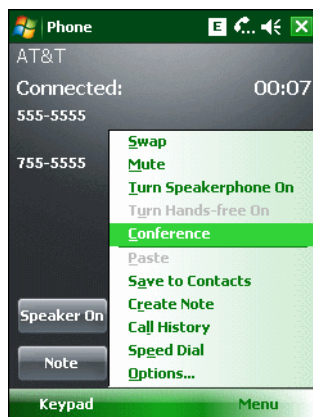

Figure 5-33 Creating a Conference Call

6. Tap **Hold** to place the conference on hold.
7. Enter another phone number and tap **Talk**.
8. After the call is answered, tap **Menu** > **Conference** to place all the calls in conference mode.
9. Repeat steps 6 through 8 for up to six phone numbers.
10. Tap **End** or press the red key to end the conference call.

✓ **NOTE** To speak privately with one party during a conference call, tap **Menu** > **Private**. To include all parties again, tap **Menu** > **Conference**.

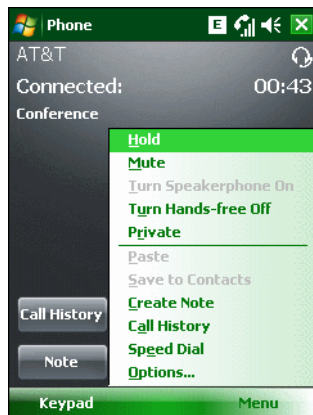

Figure 5-34 *Creating a Private Call*

Three-way Calling on an MC9598

✓ **NOTE** Three-way Calling may not be available on all services. Please check with your service provider for availability.

To create a three-way phone session with two people and you as the initiator:

1. Tap **Start** > **Phone** or press the green key to display the Phone keypad.
2. Enter the first phone number and press **Talk**.
3. To call a second person, tap **Keypad**. Enter the second number and tap **Talk**.

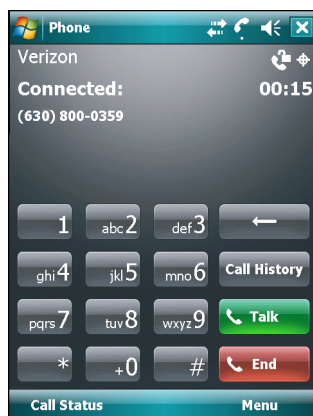

Figure 5-35 *Calling Another Person*

4. When the second person answers the call, tap **Talk** to create a three-way calling session.
5. Tap **Talk** to drop the last call.
6. Tap **End** to drop the first call.

Text Messaging

Use the **Text Messages** window to send and receive text messages to and from mobile phones. The text can contain words, numbers, or an alphanumeric combination no longer than 160 characters.

Short text messages delivered over mobile networks transmit from the sending MC9500-K, are stored in a central short message center, then forwarded to the destination mobile device. If the recipient is not available, the message is stored and can be sent later.

Viewing Text Messages

To view a text message:

You can view a text message whether the phone is on or off. When the phone is on, you can view a text message from its notification callout. Tap the **text message notification** icon on the navigation bar to display the message.

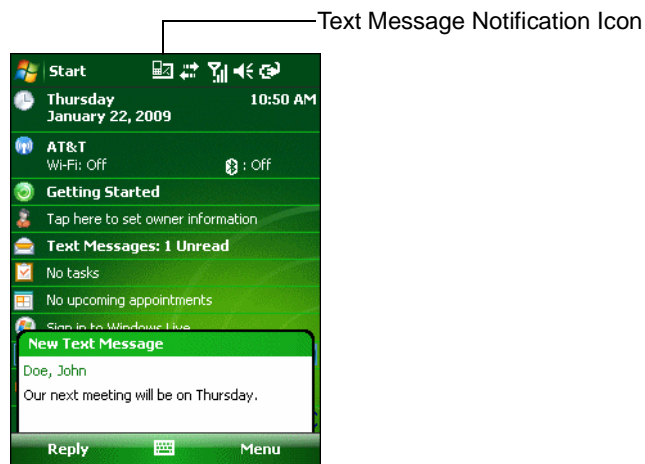

Figure 5-36 *New Text Message Notification*

The Caller Identification feature matches incoming text message numbers with those stored in **Contacts** so you know who is sending you a message. Furthermore, the **New Text Message** dialog box gives you the option to call the sender or save, dismiss, or delete the message.

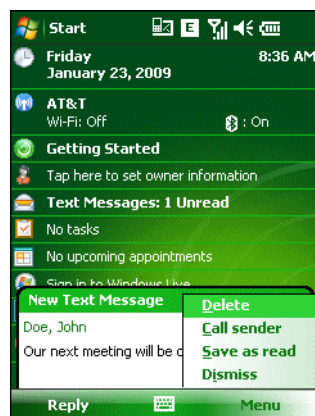

Figure 5-37 *New Text Message Options*

When the phone function is off, you can still view received text message in Messaging:

1. Tap **Start > Messaging > Text Messages**, or on the Today screen, tap **Text Messages**.

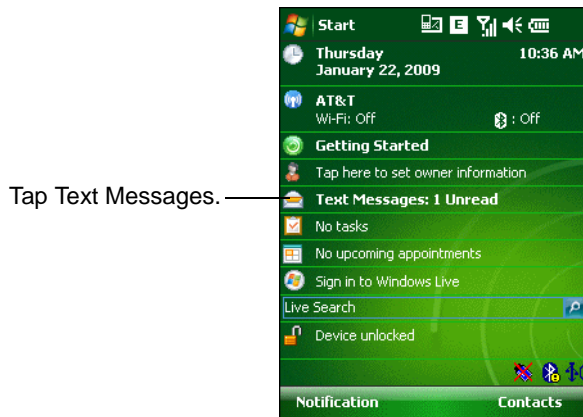

Figure 5-38 Text Messaging on Today Screen

The **Text Messages** window appears.

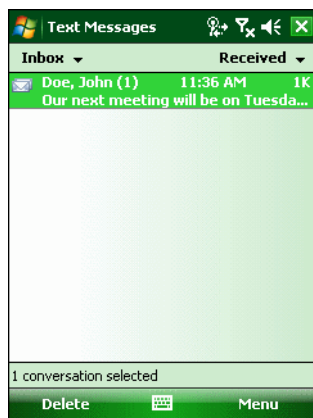
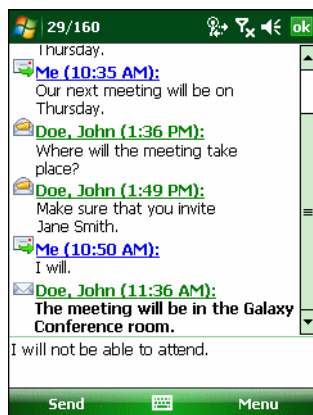

Figure 5-39 Messaging Window

2. In the message list, tap a text message. The window displays previous text conversations.



Tap to reply the message.

Figure 5-40 Text Message - Conversation

To reply, enter text in the reply field and tap **Send**.

- ✓ **NOTE** If the phone is turned off and you tried to call the sender, send a reply, or forward the message, you are prompted to turn the phone function on.

Sending a Text Message

To create a text message:

1. On the **Phone** screen, select a contact name that you want to send a message to.
2. Tap **Menu > Send Text Message**.



Figure 5-41 Phone Screen Contact List

3. Compose your message.

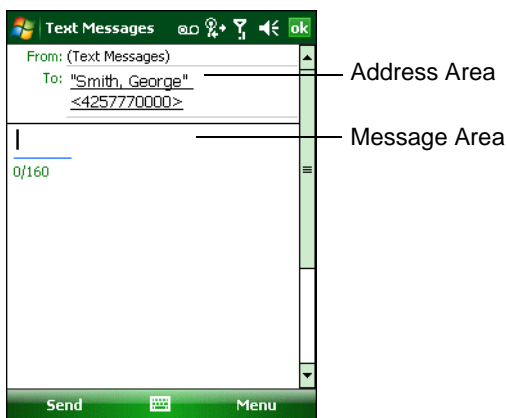

Figure 5-42 Create Text Message

- The auto-correct feature automatically fixes common spelling errors as you type so your messages are more accurate.
- The character counter lets you see and control the size of the message as you compose.
- If you want to know if your text message was received, tap **Menu > Message Options**, then select the **Request message delivery notification** check box.



Figure 5-43 *Message Options Window*

4. Tap **Send** when you've finished the message.

If the phone is turned on, your text message is sent. If it's off, you are prompted to turn on the phone. If you do so, the message is sent; otherwise when you tap **ok**, the message is saved in the **Drafts** folder and sent when the phone is turned on.

If you are out of coverage area, the message is saved in the **Drafts** folder and sent when you return to a coverage area.

- ✓ **NOTE** On the MC959X-K, the message remains in the **Drafts** folder and has to be manually re-sent when you return to a coverage area.

Establishing a MC9596 Data Connection

✓ **NOTE** Refer to the *MC9500-K Series Mobile Computer Integrator Guide* for information on configuring a data connection.

5. Ensure a SIM card is installed in the MC9500-K.
6. Configure a GPRS data connection. See *MC9500-K Series Mobile Computer Integrator Guide*.
7. Tap the connectivity icon **H**, **G** or **E** at the top of the screen.



Figure 5-44 Connectivity Dialog Box

8. Tap **Settings**.
9. Tap **Connections** icon.
10. Tap **Managing existing connections**.
11. Tap and hold on the data connection until a menu appears.

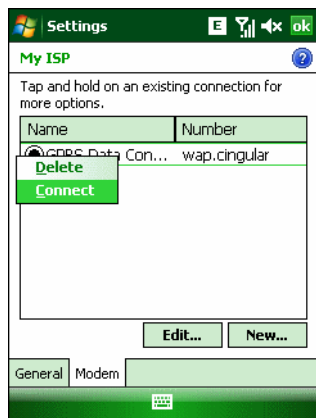

Figure 5-45 Data Connection

12. Select **Connect**.



Figure 5-46 Connecting Using GPRS

13. If the SIM card is protected with a Personal Identification Number (PIN), a dialog box pops up requesting the appropriate PIN to unlock the SIM card. In this case, enter the PIN and tap **ok**.

✓ **NOTE** Place emergency calls at any time, without entering a PIN or a SIM card.

14. When a connection is established, launch **Internet Explorer** to browse the Internet or launch an applicable application.

Ending a Data Connection

To cancel a data connection in progress, tap **Cancel** in the **Connecting...** dialog window.

To end an established data connection:

1. Tap **H**, **G** or **E** to display the **Connectivity** dialog box.

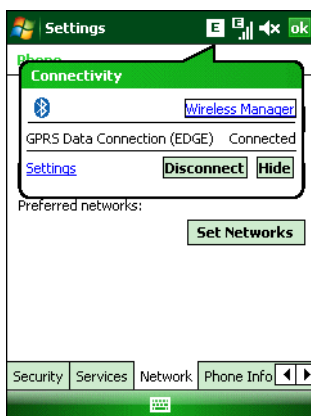

Figure 5-47 Connectivity Dialog Box

2. Tap **Disconnect**.

✓ **NOTE** Tapping **Disconnect** during an active data transfer (e.g., downloading a web page) automatically reconnects the connection. You cannot disconnect the connection until the data transfer is complete.

Establishing an MC9598 Data Connection

✓ **NOTE** Ensure that you have data service activated with your service provider.

A data connection allows Internet access across a wireless network. Data connection is pre-packaged with service accounts.

To verify active data service:

1. Tap **Start > Internet Explorer**.
2. In the address bar, enter a URL for a web site.
3. Tap  to display the **Connectivity** dialog. The dialog box displays the data connection information.

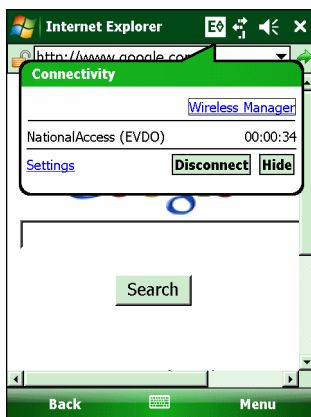

Figure 5-48 Data Connection

Ending a Data Connection

To cancel a data connection in progress, tap **Cancel** in the **Connecting...** dialog window.

To end an established data connection:

1. Tap  to display the **Connectivity** dialog box.

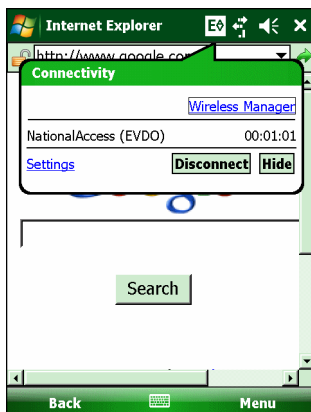

Figure 5-49 Connectivity Dialog Box

2. Tap **Disconnect**.



NOTE Tapping **Disconnect** during an active data transfer (e.g., downloading a web page) automatically reconnects the connection. You cannot disconnect the connection until the data transfer is complete.

Chapter 6 Using GPS Navigation

Introduction

The MC9500-K includes Global Positioning System (GPS) technology using the SiRFstar III chipset. GPS technology is based on a worldwide system of GPS satellites orbiting the earth that continuously transmit digital radio signals. These radio signals contain data on the satellites' locations and their exact clock time and are used to determine your location on the earth.



WARNING! When using the MC9500-K in a vehicle, it is the user's responsibility to place, secure and use in a manner that will not cause accidents, personal injury or property damage or obstruct their view. It is the responsibility of the driver to operate the vehicle in a safe manner, maintain observation of all driving conditions at all times, and not become distracted by the device to the exclusion of safe driving practices. It is unsafe to operate the controls of the device while driving.

Software Installation

Third-party GPS navigation software is required. Evaluation software is available from various suppliers. For example; VisualGPS, visit: <http://www.visualgps.net/VisualGPSce/>

If interested in purchasing GPS navigation software check with the GPS software vendor (before purchasing, downloading, or installing any software) to determine that the application is compatible with the MC9500-K. Refer to the application's user guide for application installation and setup information.

MC9500-K GPS Setup

The GPS-enabled MC9500-K uses Microsoft Windows Mobile 6, so the operating system automatically manages access to the GPS receiver to allow multiple programs to simultaneously access GPS data.

Ensure that the following settings are set on the MC9500-K:

1. Tap **Start > Settings > System > External GPS** icon.
2. In the **Programs** tab, ensure that the **GPS program port** drop-down list is set to **None**.
3. In the **Hardware** tab, ensure that the **GPS hardware port** drop-down list is set to **COM8**.

4. Ensure that the **Baud rate** drop-down list is set to **57600**.
5. Tap **ok** to close the **Setting** window.

✓ **NOTE** User can select COM port from the GPS program port drop-down list. If an application error message appears indicating that the COM port cannot be opened, ensure that a free COM port is selected.

Operation

Acquiring satellite signals may take several seconds to a few minutes. It is best to be outside and have a clear, unobstructed view of the sky. Without a clear view, acquisition takes much longer and could result in the MC9500-K being unable to compute the initial position quickly. When operating the device indoors access to the GPS signals may be limited or unavailable.

✓ **NOTE** When using a GPS navigation application, ensure that the MC9500-K does not go into suspend mode. If the MC9500-K suspends then the power to the GPS radio is removed. Upon resume the GPS receiver must reacquire a valid GPS signal, resulting in a delay of positional information.

GPS Maps on microSD Cards

GPS navigation software vendors may sell maps on microSD cards. If using a microSD card with the GPS navigation software install the microSD memory card using procedure in [Installing a microSD Card on page 1-3](#).

Answering a Phone Call While Using GPS

If you receive a phone call while using your GPS navigation software:

1. Answer the phone call by pressing the **Answer** button.
2. Once you end the phone call, press the **End Call** button to resume the audio on the GPS software.

✓ **NOTE** Anytime you are using GPS on the MC9500-K and you receive a phone call, the audio on the GPS navigation software is muted until you finish the call.

Losing the GPS Signal While in a Vehicle

GPS performance on the MC9500-K may be affected if the vehicle has thermal glass windows and windshields, which can block the MC9500-K from receiving a GPS signal from satellites. To improve GPS signal strength, place the MC9500-K where there is a clear view of the sky. A direct line of sight is required between the MC9500-K and the GPS satellites to access information from the satellites.

The Global Positioning System (GPS) is a system that allows the user to track their position anywhere on the earth.

Assisted GPS

GPS can be used in stand-alone or Assisted GPS (A-GPS) modes. A Stand-alone GPS receiver downloads data from GPS satellites. In certain environments, it can take several minutes to get a fix. By using GPS Location servers, A-GPS dramatically reduces the TTFF (Time To First Fix) and improves the sensitivity of GPS receivers by providing them with data that they would ordinarily have to download from the GPS satellites. With the A-GPS data, GPS receivers can operate faster and more reliably.

A-GPS follows the Secure User Plane Location (SUPL) protocol which allows a mobile device to communicate with a SUPL server. Refer to the EMDK Help file for information on setting up SUPL on the MC9500-K.

Chapter 7 Using Bluetooth

Introduction

Bluetooth-equipped devices can communicate without wires, using frequency-hopping spread spectrum (FHSS) radio frequency (RF) to transmit and receive data in the 2.4 GHz Industry Scientific and Medical (ISM) band (802.15.1). Bluetooth wireless technology is specifically designed for short-range (30 feet/10 meters) communication and low power consumption.

MC9500-Ks with Bluetooth capabilities can exchange information (e.g., files, appointments, and tasks) with other Bluetooth enabled devices such as phones, printers, access points, and other mobile computers. To use the MC9500-K as a modem, create a dial-up modem connection between a computer and MC9500-K.

The MC9500-K with Bluetooth technology uses either the StoneStreet Bluetooth stack or the Microsoft Bluetooth stack. To write an application that uses the StoneStreet One Bluetooth stack APIs, refer to the Enterprise Mobility Developer Kit (EMDK) Help.

Adaptive Frequency Hopping

Adaptive Frequency Hopping (AFH) is a method of avoiding fixed frequency interferers, and can be used with Bluetooth voice. All devices in the piconet (Bluetooth network) must be AFH-capable in order for AFH to work. There is no AFH when connecting and discovering devices. Avoid making Bluetooth connections and discoveries during critical 802.11b communications. AFH for Bluetooth consists of four main sections:

- Channel Classification - A method of detecting an interference on a channel-by-channel basis, or pre-defined channel mask.
- Link Management - Coordinates and distributes the AFH information to the rest of the Bluetooth network.
- Hop Sequence Modification - Avoids interference by selectively reducing the number of hopping channels.
- Channel Maintenance - A method for periodically re-evaluating the channels.

When AFH is enabled, the Bluetooth radio “hops around” (instead of through) the 802.11b high-rate channels. AFH coexistence allows Motorola mobile computers to operate in any infrastructure.

The Bluetooth radio in this MC9500-K operates as a Class 2 device power class. The maximum output power is 2.5mW and the expected range is 32.8 feet (10 meters). A definition of ranges based on power class is difficult to obtain due to power and device differences, and whether one measures open space or closed office space.



NOTE It is not recommended to perform Bluetooth wireless technology inquiry when high rate 802.11b operation is required.

Security

The current Bluetooth specification defines security at the link level. Application-level security is not specified. This allows application developers to define security mechanisms tailored to their specific need. Link-level security occurs between devices, not users, while application-level security can be implemented on a per-user basis. The Bluetooth specification defines security algorithms and procedures needed to authenticate devices, and if needed, encrypt the data flowing on the link between the devices. Device authentication is a mandatory feature of Bluetooth while link encryption is optional.

Pairing of Bluetooth devices is accomplished by creating an initialization key that is used to authenticate the devices and create a link key for them. Entering a common PIN number in the devices being paired generates the initialization key. The PIN number is never sent over the air. By default, the Bluetooth stack responds with no key when a key is requested (it is up to user to respond to the key request event). Authentication of Bluetooth devices is based-upon a challenge-response transaction. Bluetooth allows for a PIN number or passkey that is used to create other 128-bit keys used for security and encryption. The encryption key is derived from the link key used to authenticate the pairing devices. Also worthy of note is the limited range and fast frequency hopping of the Bluetooth radios that makes long-distance eavesdropping difficult.

Recommendations are:

- Perform pairing in a secure environment
- Keep PIN codes private and don't store the PIN codes in the mobile computer
- Implement application-level security.

The Microsoft stack supports Smart-pairing. For detailed information, refer to the Microsoft MSDN.

Bluetooth Configuration

By default, the MC9500-K is configured to using the StoneStreet One Bluetooth stack. Refer to the *MC9500-K Mobile Computer Integrator Guide*, Appendix B, for information on switching to the Microsoft Bluetooth stack.

If the MC9500-K is configured to use the StoneStreet One Bluetooth stack, the Bluetooth icon appears at the bottom right corner of the Today screen. If the Microsoft Bluetooth stack is configured, the Bluetooth icon does not appear.

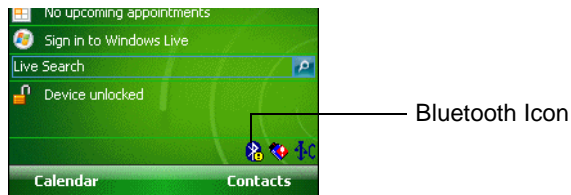

Figure 7-1 Bluetooth Icon

[Table 7-1](#) list the services supported by the StoneStreet One Bluetooth stack and the Microsoft Bluetooth stack.

Table 7-1 Bluetooth Services

Microsoft Bluetooth Stack	StoneStreet One Bluetooth Stack
OBEX Object Push Services	File Transfer Services
Hands-Free Audio Gateway Services	Dial-Up Networking Services
Serial Port Services	OBEX Object Push Services
Personal Area Networking Services	Headset Audio Gateway Services
PBAP Services	Hands-Free Audio Gateway Services
Dial-Up Networking Services	Serial Port Services
HID Client Services	Personal Area Networking Services
A2DP/AVRCP Services	IrMC Services
	HID Client Services
	A2DP/AVRCP Services

[Table 7-2](#) list the COM ports available for the StoneStreet One Bluetooth stack and the Microsoft Bluetooth stack.

Table 7-2 COM Ports

Microsoft Bluetooth Stack	StoneStreet One Bluetooth Stack
COM5	COM5
COM9	COM9
	COM11

Table 7-2 COM Ports (Continued)

Microsoft Bluetooth Stack	StoneStreet One Bluetooth Stack
	COM21
	COM22
	COM23

Bluetooth Power States

Cold Boot

With StoneStreet One Bluetooth Stack

Performing a cold boot on the MC9500-K turns off Bluetooth after initialization (which takes a few moments). It is normal to see the **Bluetooth** icon appear and disappear, as well as a wait cursor, when initialization proceeds in all modes.

With Microsoft Bluetooth Stack

Performing a cold boot retain the state of the Bluetooth radio prior to the cold boot.

Warm Boot

With StoneStreet One Bluetooth Stack

Performing a warm boot on the MC9500-K turns off Bluetooth.

With Microsoft Bluetooth Stack

Performing a warm boot retain the state of the Bluetooth radio prior to the warm boot.

Suspend

When there is an active Bluetooth connection, the Bluetooth radio goes into low power mode maintaining the active connection. When there is no active connection, the Bluetooth radio turns off.

With StoneStreet One Bluetooth Stack

- ✓ **NOTE** If there is an active Bluetooth connection between the MC9500-K and another Bluetooth device, the MC9500-K will not timeout. However, if the user presses the Power button on the MC9500-K, the MC9500-K will suspend (except when on a call) and upon receiving data from a remote Bluetooth device, the MC9500-K will wake from suspend mode. For example, headset redial or Bluetooth scanner sending data to the MC9500-K.

With Microsoft Bluetooth Stack

- ✓ **NOTE** If there is an active Bluetooth connection between the MC9500-K and another Bluetooth device and there is no data activity, the MC9500-K will timeout. However, if the user presses the Power button on the MC9500-K, the MC9500-K will suspend (except when on a call) and upon receiving data from a remote Bluetooth device, the MC9500-K will wake from suspend mode. For example, headset redial or Bluetooth scanner sending data to the MC9500-K.

Resume

When the MC9500-K resumes, Bluetooth turns on if it was on prior to suspend.

Using Microsoft Bluetooth Stack

The following sections provide information on using the Microsoft Bluetooth stack.

Turning the Bluetooth Radio Mode On and Off

Turn off the Bluetooth radio to save power or if entering an area with radio restrictions (e.g., an airplane). When the radio is off, other Bluetooth devices cannot see or connect to the MC9500-K. Turn on the Bluetooth radio to exchange information with other Bluetooth devices (within range). Communicate only with Bluetooth radios in close proximity.

✓ **NOTE** To achieve the best battery life turn off radios not in use.

Enabling Bluetooth

To enable Bluetooth:

1. Tap **Wireless Manager** and then tap the **Bluetooth** bar or
Tap **Start > Setting > Connections > Bluetooth icon > Mode** tab.

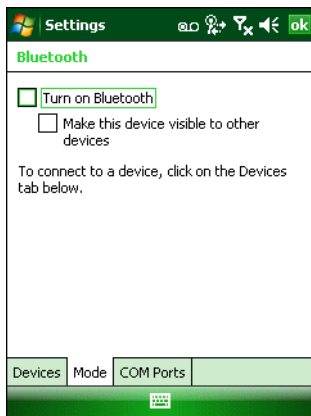

Figure 7-2 Bluetooth Mode Tab

2. Check the **Turn On Bluetooth** checkbox.
3. Tap **ok**.

Disabling Bluetooth

To disable Bluetooth:

1. Tap **Wireless Manager** and then tap the **Bluetooth** bar or
Tap **Start > Setting > Connections > Bluetooth icon > Mode** tab.
2. Un-check the **Turn On Bluetooth** checkbox.

3. Tap **ok**.

Discovering Bluetooth Device(s)

The MC9500-K can receive information from discovered devices without bonding. However, once bonded, the MC9500-K and a bonded device exchange information automatically when you turn the Bluetooth radio on. See [Bonding with Discovered Device\(s\) on page 7-34](#) for more information.

To find Bluetooth devices in the area:

1. Ensure that Bluetooth is enabled on both devices.
2. Ensure that the Bluetooth device to discover is in discoverable and connectable modes.
3. Ensure that the two devices are within 30 feet (10 meters) of one another.
4. Tap **Start > Settings > Connections** tab > **Bluetooth** icon > **Devices** tab.



Figure 7-3 Bluetooth - Devices Tab

5. Tap **Add new device**. The MC9500-K begins searching for discoverable Bluetooth devices in the area.



Figure 7-4 Searching for Bluetooth Devices

6. Select a device from the list.



Figure 7-5 *Select a Bluetooth Device*

7. Tap **Next**. The **Enter Passcode** window appears.



NOTE If Smart-pairing is configured and the device is requesting one of the pre-defined PINs, the **Enter Passcode** window does not appear.

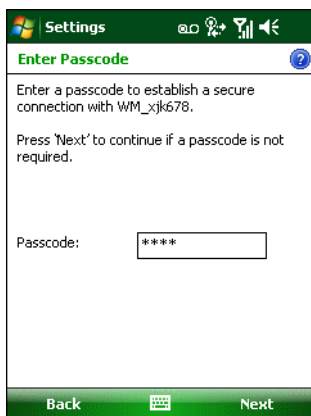

Figure 7-6 *Enter Passcode*

8. Enter the Passcode on the other device. The device is added to the Bluetooth list.

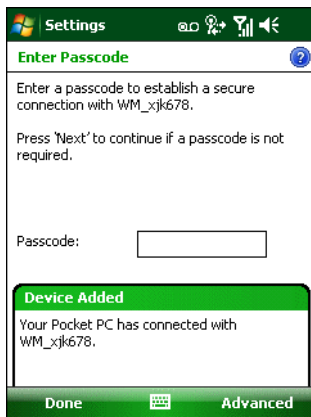

Figure 7-7 Bluetooth Connection Confirmation

You are prompted to enter a passcode. If the device has a specific passcode, enter it in the Passcode field and tap **Next**. If the device does not have a specific passcode, enter a passcode in the Passcode field and tap **Next**. The Bluetooth radio tries to connect with the device.

9. If you created a passcode, you will be prompted by the other device to enter the same passcode. Enter the created passcode to establish a paired connection. (If you entered a passcode from the device, you shouldn't have to do anything on the other device.)
10. When the connection is complete, a list of matching and supported services on the device appears.
11. Select the services you want to use and tap Finish. The services on the new devices have to be selected or else the pairing won't include those services, even though the devices are paired. If services are not selected, you will be continually reprompted for the passcode from the device.
12. The device appears in the list on the main window.

After the passcodes have been accepted on both sides, you have a trusted ("paired") connection.

Available Services

✓ **NOTE** Some devices might not require a PIN. This depends upon the device's authentication.

The MC9500-K with Microsoft Bluetooth stack offers the following services:

- OBEX Object Push Services via Beam
- Hands-Free Audio Gateway Services
- Serial Port Services
- Personal Area Networking Services
- PBAP Services
- Dial-up Networking
- HID Client
- A2DP/AVRCP.

See the following sections for information on these services.

Object Push Services via Beam

✓ **NOTE** You can only send files to a remote device using the Beam function.

Use the OBEX Push Service to send files and contacts to another Bluetooth device. To transfer files between the MC9500-K and another Bluetooth enabled device:

1. Ensure that Bluetooth is enabled and discoverable on both devices.
2. Ensure that the two devices are within 30 feet (10 meters) of one another.
3. Tap **Start > Programs > File Explorer**.
4. Navigate to the file to transfer.
5. Tap and hold on the filename until the pop-up menu appears.

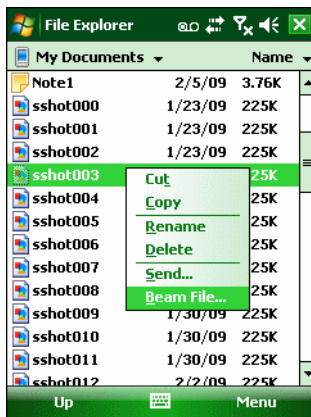

Figure 7-8 File Explorer Window

6. Select **Beam File**. The MC9500-K searches for Bluetooth devices in the area.
7. Tap **Tap to send** next to the Bluetooth device to send the file to. The MC9500-K communicates with the device and send the file. When completed, **Tap to send** changes to **Done**.

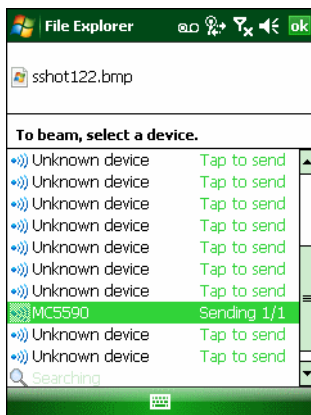

Figure 7-9 Beam File Window

To transfer a contact between the MC9500-K and another Bluetooth enabled device:

1. Ensure that Bluetooth is enabled and discoverable on both devices.

2. Ensure that the two devices are within 30 feet (10 meters) of one another.
3. Tap **Start > Contacts**
4. Navigate to the contact to transfer.
5. Tap and hold on the contact until the pop-up menu appears.

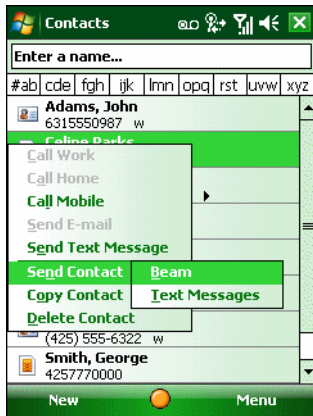

Figure 7-10 Contact Window

6. Select **Send Contact > Beam**. The MC9500-K searches for Bluetooth devices in the area.
7. Tap **Tap to send** next to the Bluetooth device to send the file to. The MC9500-K communicates with the device and send the contact. When completed, **Tap to send** changes to **Done**.

Internet Sharing

Internet Sharing allows the user to connect a computer or laptop to the MC9500-K and use the MC9500-K as a modem to connect to an office network or ISP.

To use MC9500-K as a modem using Bluetooth:

1. Ensure that the device is not connected to the computer or laptop.
2. On the MC9500-K, ensure that the Phone is on and a data connection is configured.
3. Tap **> Programs > Internet Sharing**.
4. In the **PC Connection** list, select **Bluetooth PAN**.
5. In the **Network Connection** list, select the connection type.
Select the network connection that the device should use to connect to the Internet.
6. Tap **Connect**.
7. On the computer or laptop, setup a Bluetooth PAN with your device.
 - a. Select **Start > Control Panel > Network Connections**.
 - b. Under **Personal Area Network**, select **Bluetooth Network Connection**.
 - c. Right-click on **Bluetooth Network Connection** and select **View Bluetooth** network devices.
 - d. In the **Bluetooth Personal Area Network Devices** window select your device.

- e. Click **Connect**. The computer connects to the device via Bluetooth.

✓ **NOTE** If your computer is Bluetooth-enabled and you select Bluetooth as the PC connection, you must initiate and complete the Bluetooth PAN partnership before Internet Sharing will work. For more information, refer to Windows Help and Support.

8. To verify, on the PC or laptop, launch **Internet Explorer** and open a web site.
9. To end dial-up networking, on the MC9500-K tap **Disconnect**.

Hands-free Services

To connect to a Bluetooth headset:

✓ **NOTE** Newer Bluetooth headsets are device dependant and remember the last device they connected to. If problems occur while connecting to the headset, place the headset in discovery mode. Refer to the headset user manual for more information.

Only WAN audio is routed to the headset. System audio is still emitted through the MC9500-K speaker.

You can accept calls and re-dial using the Hands-free profile.

Hands-free profile does not support 3-way calling.

1. Ensure that Bluetooth is enabled and discoverable on both devices.
2. Ensure that the two devices are within 30 feet (10 meters) of one another.
3. Tap **Start > Settings > Connections > Bluetooth** icon.
4. Tap **New device**. The MC9500-K searches for Bluetooth devices in the area.
5. Select the headset name and tap **Next**. The Passcode window appears.
6. Enter the headset's passcode.
7. Tap **Next**. The MC9500-K connects to the headset. Refer to the headset user manual for instructions on communicating with a Bluetooth device.

✓ **NOTE** During an active connection, the MC9500-K cannot go into suspend mode when the Power Button is pressed. A message appears notifying the user.

Once the WAN call is disconnected (with Hands-free profile) the Power button is enabled.

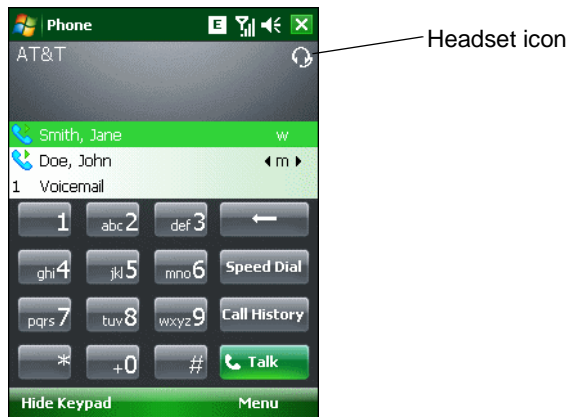

Figure 7-11 WWAN Bluetooth Audio Notification Dialog Box

Serial Port Services

Use the wireless Bluetooth serial port connection as you would a physical serial cable connection. Configure the application that will use the connection to the correct serial port.

To establish a serial port connection:

1. Ensure that Bluetooth is enabled and discoverable on both devices.
2. Ensure that the two devices are within 30 feet (10 meters) of one another.
3. Tap **Start > Settings > Connections** tab > **Bluetooth** icon > **Devices** tab.
4. Tap **Add new device**. The MC9500-K begins searching for discoverable Bluetooth devices in the area.
5. Select a device from the list.
6. Tap **Next**. The **Enter Passcode** window appears.

✓ **NOTE** If Smart-pairing is configured and the device is requesting one of the pre-defined PINs, the **Enter Passcode** window does not appear.

7. Enter the Passcode and tap **Next**. The device is added to the Bluetooth list.
8. In the device list, tap the serial device. The **Partnership Settings** window displays.
9. Select the **Serial Port** checkbox.
10. Tap **Save**.
11. Tap **COM Ports** tab.
12. Tap **New Outgoing Port**. The add device window appears.
13. Select the serial device in the list and then tap **Next**.
14. Select a COM port from the drop-down list.
15. Tap **Finish**.

✓ **NOTE** No connection is made at this point. An application must open the selected COM port to trigger Microsoft Bluetooth stack to open the connection.

ActiveSync Using Serial Port Services

Use the wireless Bluetooth serial port connection for ActiveSync just as you would a physical serial cable connection. You must configure the application that will use the connection to the correct serial port.

To set up a Bluetooth ActiveSync connection:

Before setting up a Bluetooth ActiveSync connection, configure the Bluetooth function of your device.

- ✓ **NOTE** For additional security, disable network bridging on the computer (specifically, bridging to a Remote NDIS adapter) before connecting to the computer to pass through to the Internet or a network. For more information on network bridging, see **Windows Help** on your computer.

The instructions below are for computers that support the Windows XP SP2 or later version operating system.

1. Ensure that Bluetooth is enabled and discoverable on both devices.
2. Ensure that the two devices are within 30 feet (10 meters) of one another.
3. On the computer, click **Start > Settings > Control Panel**.
4. Double-click **Bluetooth Devices**.
5. On the **Options** tab, select the **Turn discovery on** and **Allow Bluetooth devices to connect to this computer** checkboxes.

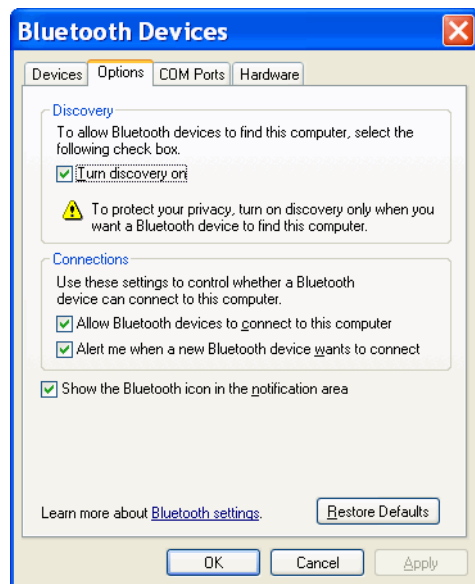

Figure 7-12 Computer Bluetooth Devices Window

6. On the **COM Ports** tab, click **Add**.
7. Select the **Incoming (device initiates the connection)** option, then click **OK**.
Note the number of the COM port that was added.
8. Click **OK**.
9. Click **Start > All Programs > Microsoft ActiveSync**.
10. Click **File > Connection Settings**.



Figure 7-13 ActiveSync Connection Settings

11. On the **Allow connections to one of the following** drop-down list, select the COM port with the number you noted earlier.
12. On the MC9500-K, tap **Start > Programs > ActiveSync**.
13. Tap **Menu > Connect via Bluetooth**.

Synchronization is automatically initiated. The **ActiveSync** icon appears on the lower right corner of the **Today** screen.

If an Authentication is required, the **Enter Passcode** screen appears, type an alphanumeric passkey (PIN code), then tap **Next**; enter the same passkey on the other device.

The passkey is recommended for enhanced security. Your passkey must be between 1 to 16 alphanumeric characters.

If you do not want to use a passkey, tap **Next**.

14. To disconnect the ActiveSync connection, tap the **ActiveSync** icon on the Today screen.
15. Tap **Disconnect**.

Phone Book Access Profile Services

Phone Book Access profile (PBAP) is used to synchronize contacts between a remote device and the MC9500-K. To establish an PBAP synchronization:

1. Ensure that Bluetooth is enabled and discoverable on both devices.
2. Ensure that the two devices are within 30 feet (10 meters) of one another.
3. Tap **Start > Settings > Connection** tab > **Bluetooth** icon > **Devices** tab.
4. Tap **Add New Device**. The MC9500-K searches for a Bluetooth device, such as a Car Kit.
5. Select a device from the list.
6. Tap **Next**. The **Enter Passcode** window appears.

✓ **NOTE** If Smart-pairing is configured and the device is requesting one of the pre-defined PINs, the **Enter Passcode** window does not appear.

7. Enter the Passcode and the tap **Next**. The device is added to the Bluetooth list.

8. A dialog box appears requesting if you want to transfer contacts to the car kit.
9. Select **Yes** or **No**.
10. If **Yes** is selected, contacts from the MC9500-K are transferred to the car kit.

Dial-Up Networking Services

Dial-up networking allows the user to connect a PC or laptop to the MC9500-K and use the MC9500-K as a modem to connect to an office network or ISP.

Before setting up dial-up networking, obtain dial-up information and other necessary settings (username, password and domain name, if required) for the office network or ISP. To create a new Bluetooth connection:

1. Ensure the MC9500-K is discoverable and connectable.
2. On the PC or laptop, set up Bluetooth according to the manufacturer's instructions.
3. On the PC or laptop Bluetooth software, search for the MC9500-K and select the Dial-up Networking service.
4. Using dial-up software on the PC or laptop, connect to the MC9500-K.
5. The MC9500-K phone function dials the ISP number and connects to the ISP.
6. To verify, on the PC or laptop, launch Internet Explorer and open a web site.

Connect to a HID Device

The MC9500-K can connect to an Human Interface Device (HID) device such as a Bluetooth keyboard or mouse:

1. Ensure that Bluetooth is enabled on both devices.
2. Ensure that the Bluetooth device to discover is in discoverable and connectable modes.
3. Ensure that the two devices are within 30 feet (10 meters) of one another.
4. Tap **Start > Settings > Connections** tab > **Bluetooth** icon > **Devices** tab.
5. Tap **Add new device**. The MC9500-K begins searching for discoverable Bluetooth devices in the area.
6. Select a HID device from the list.
7. Tap **Next**. The **Enter Passcode** window appears. Refer to the device's User Manuals for more information.

✓ **NOTE** If Smart-pairing is configured and the device is requesting one of the pre-defined PINs, the **Enter Passcode** window does not appear.

8. Tap **Connect**. The MC9500-K connects to the HID device.

A2DP/AVRCP Services

A2DP/AVRCP is used to connect to a high-quality stereo headset:

1. Ensure that Bluetooth is enabled on both devices.
2. Ensure that the Bluetooth device to discover is in discoverable and connectable modes.
3. Ensure that the two devices are within 30 feet (10 meters) of one another.
4. Tap **Start > Settings > Connections** tab > **Bluetooth** icon > **Devices** tab.

5. Tap **Add new device**. The MC9500-K begins searching for discoverable Bluetooth devices in the area.
6. Select a stereo headset from the list.
7. Tap **Next**. The **Enter Passcode** window appears. Refer to the device's User Manuals for more information.

✓ **NOTE** If Smart-pairing is configured and the device is requesting one of the pre-defined PINs, the **Enter Passcode** window does not appear.

8. Tap **Connect**. The MC9500-K connects to the stereo headset.

For stereo headsets that can use hands-free services, connect to the hands-free service after connecting to the A2DP service:

1. Tap **Start > Settings > Connections** tab > **Bluetooth** icon > **Devices** tab.
2. Tap **Add new device**. The MC9500-K begins searching for discoverable Bluetooth devices in the area.
3. Select a stereo headset from the list.
4. Tap **Next**. The **Enter Passcode** window appears. Refer to the device's User Manuals for more information.

✓ **NOTE** If Smart-pairing is configured and the device is requesting one of the pre-defined PINs, the **Enter Passcode** window does not appear.

5. Tap **Connect**. The MC9500-K connects to the stereo headset.

Using StoneStreet One Bluetooth Stack

The following sections provide information on using the StoneStreet One Bluetooth stack.

Turning the Bluetooth Radio Mode On and Off

Turn off the Bluetooth radio to save power or if entering an area with radio restrictions (e.g., an airplane). When the radio is off, other Bluetooth devices cannot see or connect to the MC9500-K. Turn on the Bluetooth radio to exchange information with other Bluetooth devices (within range). Communicate only with Bluetooth radios in close proximity.

✓ **NOTE** To achieve the best battery life turn off radios not in use.

Disabling Bluetooth

To disable Bluetooth, tap **Bluetooth** icon > **Disable Bluetooth**. The **Bluetooth** icon changes to indicate that Bluetooth is disabled.

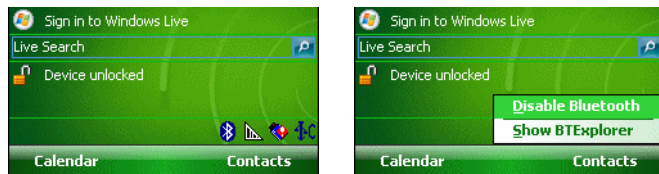

Figure 7-14 *Disable Bluetooth*

Enabling Bluetooth

To enable Bluetooth, tap **Bluetooth** icon > **Enable Bluetooth**. The **Bluetooth** icon changes to indicate that Bluetooth is enabled.



Figure 7-15 *Enable Bluetooth*

Modes

The BTExplorer application has two modes for managing Bluetooth connections: Wizard Mode and Explorer Mode. The Wizard Mode is for novice Bluetooth users and the Explorer Mode is for experienced Bluetooth users. To switch between modes, select **View > Wizard Mode** or **View > Explorer Mode**.

Wizard Mode

Wizard Mode provides a simple process for discovering and connecting to Bluetooth devices.

✓ **NOTE** Switching between Wizard Mode and Explorer Mode closes all active connections.

Wizard Mode shows the devices and services in a simple Favorites view created by following the step-by-step wizard.

Explorer Mode

The **Explorer Mode** window is easy to navigate and provides greater control to users familiar with Bluetooth. The menu bar provides quick access to the options and tools used to connect to devices. To access Explorer Mode, tap **View > Explorer Mode**.

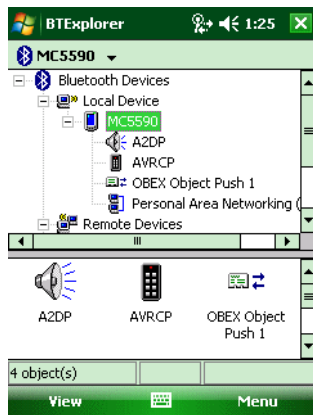

Figure 7-16 Explorer Mode Window

You can also use the “tap and hold” technique to view available options. Scroll bars and view options are similar to those on the Windows desktop. The tree structure lists the following sub-items:

- Local Device - This device
- Remote Device - Other Bluetooth devices
 - Trusted Devices - Bonded (paired) Bluetooth devices
 - Untrusted Devices - Discovered devices that are not bonded
- Favorites - Selected services that are set as *Favorite* for quick access.



NOTE Switching between Wizard Mode and Explorer Mode closes all active connections.

Discovering Bluetooth Device(s)

The MC9500-K can receive information from discovered devices without bonding. However, once bonded, the MC9500-K and a bonded device exchange information automatically when you turn the Bluetooth radio on. See [Bonding with Discovered Device\(s\) on page 7-34](#) for more information.

To find Bluetooth devices in the area:

1. Ensure that Bluetooth is enabled on both devices.
2. Ensure that the Bluetooth device to discover is in discoverable and connectable modes.
3. Ensure that the require profile is enabled on the MC9500-K. See [Profiles Tab on page 7-47](#) for more information.
4. Ensure that the two devices are within 30 feet (10 meters) of one another.

5. Tap the **Bluetooth** icon and select **Show BTE Explorer**. The **BTE Explorer** window appears.

✓ **NOTE** If favorite connections have already been created, the **Favorites** screen displays. If no favorite connections have been created, the **New Connection Wizard** screen displays.

6. Tap **Menu > New Connection**. The **New Connection Wizard** appears.

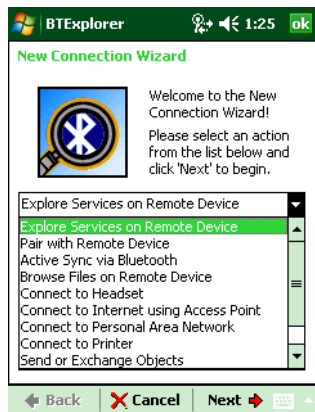

Figure 7-17 BTE Explorer Window

7. Select **Explore Services on Remote Device** or another from the drop-down list and tap **Next**.

The following actions are available in the drop-down list (actions may vary depending upon configurations):

- Explore Services on Remote Device
- Pair with a Remote Device
- Active Sync via Bluetooth
- Browse Files on Remote Device
- Connect to Headset
- Connect to Internet using Access Point
- Connect to Internet using Phone/Modem
- Connect to Personal Area Network
- Connect to Printer
- Send or Exchange Objects
- Associate Serial Port
- Connect to High-Quality Audio.

✓ **NOTE** If a device discovery action has not been previously performed, a device discovery is automatically initiated. If a device discovery has previously been performed, the device discovery process is skipped, and the previously found list of devices displays. To start a new device discovery, tap and hold in the window and select **Discover Devices** from the pop-up menu.

8. **BTE Explorer** searches for Bluetooth devices in the area.

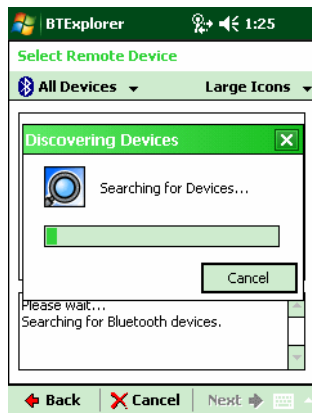

Figure 7-18 Discover Devices Dialog Box

The discovered devices display in the **Select Remote Device** window.

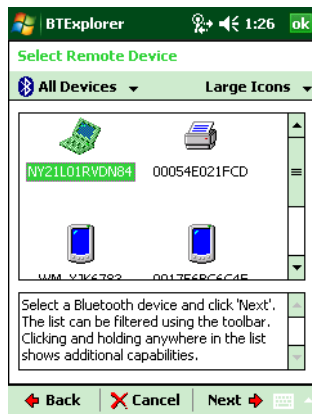

Figure 7-19 Select Remote Device Window

9. Select a device from the list and tap **Next**. The MC9500-K searches for services on the selected Bluetooth device.

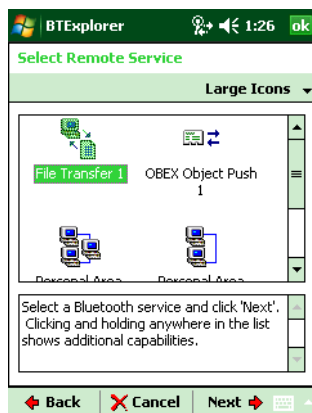

Figure 7-20 Device Services



NOTE If the MC9500-K discovers a service but the service is not supported, the service icon is grayed-out.

10. Select a service from the list and press **Next**. The **Connection Favorite Options** window appears.



Figure 7-21 Connection Favorite Options Window

11. In the **Favorite Name** text box, enter a name for this service that will appear in the **Favorite** window.

12. Tap **Next**. The **Connection Summary** window appears.

13. Tap **Connect** to add the service to the **Favorite** window and connect to the service.

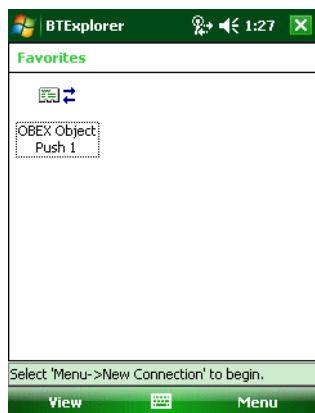

Figure 7-22 Favorites Window

Available Services

✓ **NOTE** Some devices might not require a PIN. This depends upon the device's authentication.

The MC9500-K offers the following services:

- File Transfer Services
- Dial-Up Networking Services
- OBEX Object Push Services
- Headset Audio Gateway Services
- Hands-Free Audio Gateway Services
- Serial Port Services

- Personal Area Networking Services
- IrMC Services
- A2DP/AVRCP.

See the following sections for information on these services.

File Transfer Services

✓ **NOTE** Shared folders are a security risk.

To transfer files between the MC9500-K and another Bluetooth enabled device:

1. Ensure that OBEX File Transfer profile is enabled on the MC9500-K. See [Profiles Tab on page 7-47](#) for more information.

✓ **NOTE** If favorite connections have already been created, the **Favorites** screen displays. If no favorite connections have been created, the **New Connection Wizard** screen displays.

2. Use the **Connection Wizard** to search for a Bluetooth device.
3. Select the device and tap **Next**. The **Select Remote Service** window appears.
4. Tap **Next**. The **Connection Favorite Options** window appears.
5. Tap **Next**. The **Connection Summary** window appears.
6. Tap **Connect**. The remote device's accessible folders appear.

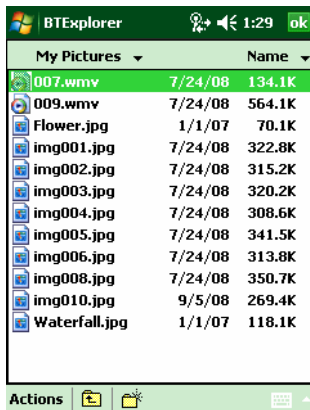

Figure 7-23 File Transfer Window

7. Double-tap the file to copy. The **Save Remote File** window appears.

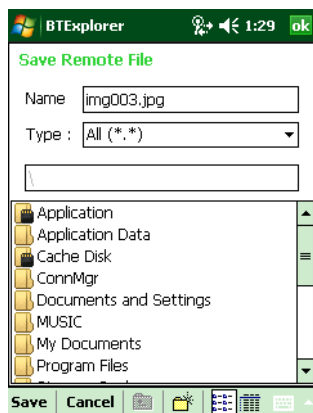

Figure 7-24 Save Remote File Window

8. Tap and hold on the file. A pop-up menu appears.
9. Select the action to perform:
 - **New** - create a new file or folder on the remote device
 - **Delete** - delete the selected file on the remote device.
 - **Get File** - copy the file from the remote device to the MC9500-K.
 - **Put File** - copy a file from the MC9500-K to the remote device.

Creating a New File or Folder

To create a new folder or file on the remote device:

1. Tap and hold on the screen and select **New > Folder** or **New > File**. The **Create New Folder** or **Create New File** window appears.
2. Enter the name for the new folder or file.
3. Tap **OK** to create the new folder or file on the remote device.

Deleting a File

To delete a file from the remote device:

1. Tap and hold on the file to delete and select **Delete**.
2. In the **Delete Remote Device File** dialog box tap **Yes**.

Getting a File

To copy a file from a remote device:

1. Double-tap or tap and hold on the file and select **Get**. The **Save Remote File** window appears.
2. Navigate to the directory to save the file.
3. Tap **Save**. The file is transferred from the remote device to the MC9500-K.

Copying a File

To copy a file to a remote device:

1. Tap **Action** > **Put**. The **Send Local File** window appears.
2. Navigate to the directory to save the file and select a file.
3. Tap **Open**. The file copies from the MC9500-K to the remote device.

Connecting to the Internet Using an Access Point

This section explains how to access a Bluetooth-enabled LAN access point (AP) for a network connection. Use Internet Explorer to connect to a server.

1. Ensure the MC9500-K is discoverable and connectable. See [Device Info Tab on page 7-36](#).
2. Ensure that the **Personal Area Networking** profile is enabled on the MC9500-K. See [Profiles Tab on page 7-47](#) for more information.
3. Use the **Connection Wizard** to search for a Bluetooth AP.
 **NOTE** If favorite connections have already been created, the **Favorites** screen displays. If no favorite connections have been created, the **New Connection Wizard** screen displays.
4. Select the **Personal Area Network** or **Network Access** service and select **Connect** from the pop-up menu. The MC9500-K connects with the access point.
5. Tap **Start** > **Internet Explorer**. The **Internet Explorer** window appears.
6. In the address field, enter an internet address and tap the **Enter** button. The web page loads.

-  **NOTE** Network Access profile is not supported.

Dial-Up Networking Services

Dial-up networking allows the user to connect a PC or laptop to the MC9500-K and use the MC9500-K as a modem to connect to an office network or ISP.

Before setting up dial-up networking, obtain dial-up information and other necessary settings (username, password and domain name, if required) for the office network or ISP. To create a new Bluetooth connection:

1. Ensure the MC9500-K is discoverable and connectable. See [Device Info Tab on page 7-36](#).
2. Ensure that the **Dial-Up Networking** profile is enabled on the MC9500-K. See [Profiles Tab on page 7-47](#) for more information.

3. Tap **Menu** > **Settings** > **Services** tab.
4. Tap **Add** button.
5. Select **Dial-up networking Service**.
6. Tap **OK**. The **Edit Local Services** window appears.

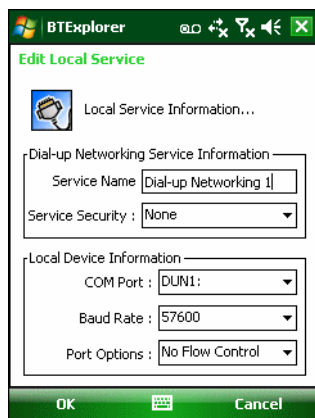

Figure 7-25 *Edit Local Service Window*

7. In the **Local COM Port** drop-down list, select **DUN1** for GSM configurations or **WMP9** for CDMA configurations.
8. Tap **OK** twice.
9. On the PC or laptop, set up Bluetooth according to the manufacturer's instructions.
10. On the PC or laptop Bluetooth software, search for the MC9500-K and select the Dial-up Networking service.
11. Using dial-up software on the PC or laptop, connect to the MC9500-K.
12. The MC9500-K phone function dials the ISP number and connects to the ISP.
13. To verify, on the PC or laptop, launch Internet Explorer and open a web site.

Object Exchange Push Services

Object Exchange (OBEX) is a set of protocols that allows sharing objects such as Contacts or pictures using Bluetooth.

To exchange contact information with another Bluetooth enabled device:

1. Ensure the MC9500-K is discoverable and connectable. See [Device Info Tab on page 7-36](#).
2. Ensure that the **OBEX Object Push** profile is enabled on the MC9500-K. See [Profiles Tab on page 7-47](#) for more information.

✓ **NOTE** If favorite connections have already been created, the **Favorites** screen displays. If no favorite connections have been created, the **New Connection Wizard** screen displays.

3. Use the **Connection Wizard** to search for a Bluetooth device.
4. Select the device and tap **Next**.
5. Select the **OBEX Object Push** service and select **Connect**. The **OBEX Object Push** window appears.

- In the **Action** drop-down list, select one of the following options: **Send Contact Information**, **Swap Contact Information**, **Fetch Contact Information**, or **Send a Picture**.

Sending a Contact

To send a contact to another device:

- ✓ **NOTE** Prior to sending and receiving contacts, a default contact must be set up before attempting to send a contact.

- Tap and hold on **OBEX Object Push** and select **Connect**. The **OBEX Object Push** window appears.

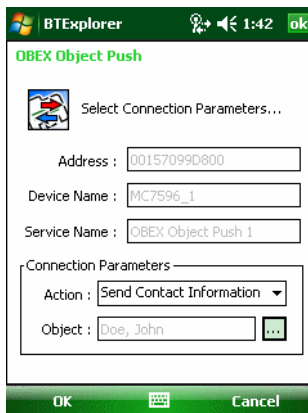



Figure 7-26 *OBEX Object Push Window*

- In the **Action:** drop-down list, select **Send Contact Information**.
- Tap . The **Select Contact Entry** window appears.

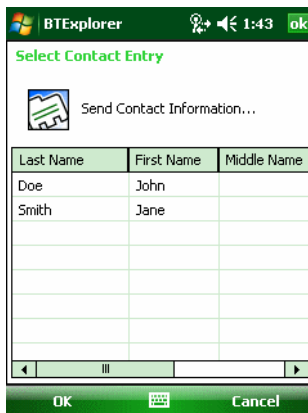

Figure 7-27 *Select Contact Entry Window*

- Select a contact to send to the other device.
- Tap **OK**.
- Tap **OK** to send the contact to the other device and display a confirmation dialog box on the other device to accept the contact. A **Send Contact** dialog appears.
- Tap **Ok**.

Swapping Contacts

To swap contacts with another device:

- ✓ **NOTE** Prior to swapping contacts, a default contact must be set up before attempting to send a contact.
Ensure that the MC9500-K is connectable.

1. Tap and hold on **OBEX Object Push** and select **Connect**. The **OBEX Object Push** window appears.

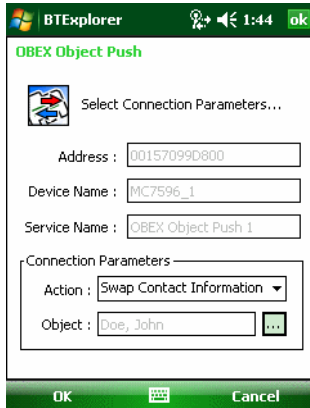

Figure 7-28 OBEX Object Push Window

2. In the **Action:** drop-down list, select **Swap Contact Information**.
3. Tap . The **Select Contact Entry** window appears.

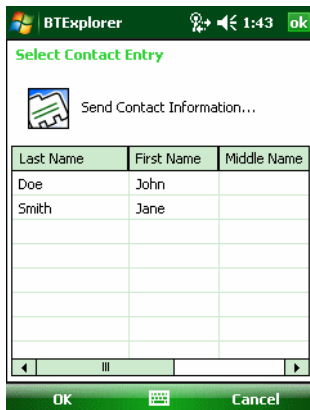

Figure 7-29 Select Contact Entry Window

4. Select a contact to send to the other device.
5. Tap **OK**.
6. Tap **OK** to swap contacts with the other device and display a confirmation dialog box on the other device to accept the contact.
7. Tap **Ok**.

Fetching a Contact

To fetch a contact from another device:

- ✓ **NOTE** Prior to sending and receiving contacts, a default contact must be set up before attempting to send a contact. Ensure that the MC9500-K is connectable.

1. Tap and hold on **OBEX Object Push** and select **Connect**. The **OBEX Object Push** window appears.

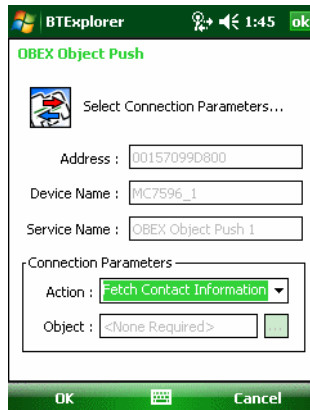

Figure 7-30 OBEX Object Push Window

2. In the **Action:** drop-down list, select **Fetch Contact information**.
3. Tap **OK**. The contact on the other device is copied.

Sending a Picture

To send a picture to another device:

1. Tap and hold on **OBEX Object Push** and select **Connect**. The **OBEX Object Push** window appears.

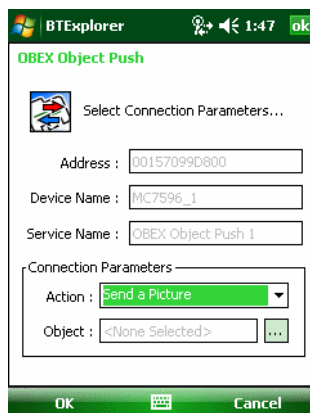

Figure 7-31 OBEX Object Push Window

2. In the **Action:** drop-down list, select **Send A Picture**.
3. Tap . The **Send Local Picture** window appears.

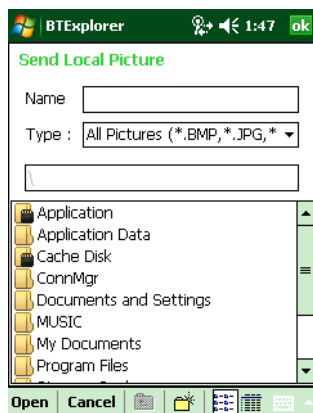

Figure 7-32 Send Local Picture Window

4. Navigate to the picture to send to the other device.
5. Tap **Open**.
6. Tap **OK** to send the picture to the other device and display a confirmation dialog box on the other device to accept the picture. A **Send Picture** dialog appears.
7. Tap **Ok**.

Headset Services

To connect to a Bluetooth headset:

- ✓ **NOTE** Newer Bluetooth headsets are device dependant and remember the last device they connected to. If problems occur while connecting to the headset, place the headset in discovery mode. Refer to the headset user manual for more information.
 - ✓ **NOTE** The headset tries to initiates the connection. If a connection is not established, then the Headset service is not enabled.
1. Ensure the MC9500-K is connectable (required when automatic re-connect is initiated). See [Device Info Tab on page 7-36](#).
 2. Ensure that the **Headset** Audio Gateway service is enabled on the MC9500-K (required when automatic re-connect is initiated). See [Services Tab on page 7-37](#) for more information.
 3. Use the **Connection Wizard** to search for a Bluetooth headset.
 4. Select the device and tap **Next**.
 5. Select the **Headset** service name and select **Connect**. The MC9500-K connects to the headset. Refer to the headset user manual for instructions on communicating with a Bluetooth device.
 - ✓ **NOTE** When using a Bluetooth headset with Headset Services, you cannot accept or end a call from the headset. You must accept or end a call on the MC9500-K.
 6. Press the communication button on the headset. This routes both system and WAN call audio to the headset.
 7. When a call is received on the MC9500-K, tap the **Accept** button to answer the call.
 8. Press the communication button on the headset to route the audio back to the MC9500-K.

Hands-free Services

To connect to a Bluetooth headset:

- ✓ **NOTE** Newer Bluetooth headsets are device dependant and remember the last device they connected to. If problems occur while connecting to the headset, place the headset in discovery mode. Refer to the headset user manual for more information.

Only WAN audio is routed to the headset. System audio is still emitted through the MC9500-K speaker.

You can accept calls and re-dial using the Hands-free profile.

Hands-free profile does not support 3-way calling.

1. Ensure the MC9500-K is connectable (required when automatic re-connect is initiated). See [Device Info Tab on page 7-36](#).
2. Ensure that the **Hands Free** profile is enabled on the MC9500-K. See [Profiles Tab on page 7-47](#) for more information.
3. Use the **Connection Wizard** to search for a Bluetooth hands-free headset.
4. Select the hand-free device and tap **Next**.
5. Select the **Hands-free** service name and select **Connect**. The MC9500-K connects to the headset. Refer to the headset user manual for instructions on communicating with a Bluetooth device.
6. During an active connection, the MC9500-K cannot go into suspend mode when the Power Button is pressed. A message appears notifying the user.

Once the WAN call is disconnected (with Hands-free profile) the Power button is enabled.

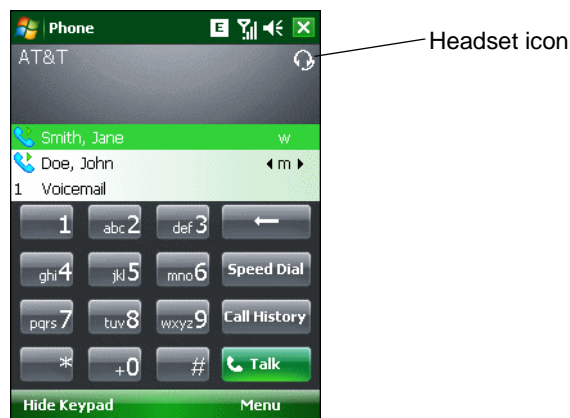

Figure 7-33 WWAN Bluetooth Audio Notification Dialog Box

Serial Port Services

Use the wireless Bluetooth serial port connection as you would a physical serial cable connection. Configure the application that will use the connection to the correct serial port.

To establish a serial port connection:

1. Use the **Connection Wizard** to search for a Bluetooth serial device.
2. Select the device and tap **Next**. The **Connection Favorite Options** window appears.

3. In the **Local COM Port:** drop-down list select a COM port.
4. Tap **Finish**.

ActiveSync Using Serial Port Services

- ✓ **NOTE** By default, COM ports COM5, COM9, COM11, COM21, COM22 and COM23 are Bluetooth virtual ports. If an application opens one of these ports, the Bluetooth driver activates and guides you through a Bluetooth connection.

Use the wireless Bluetooth serial port connection for ActiveSync just as you would a physical serial cable connection. You must configure the application that will use the connection to the correct serial port.



Figure 7-34 ActiveSync Connection Settings Window on PC

To establish an ActiveSync connection:

1. Ensure that the **Sync** profile is enabled on the MC9500-K. See [Profiles Tab on page 7-47](#) for more information.
2. Use the **Connection Wizard** to search for a Bluetooth device, such as a PC. In the drop-down list select **ActiveSync via Bluetooth**.
3. Select the device and tap **Next**. The **Connection Favorite Options** window appears.
4. Tap **Connect**. The **Remote Service Connection** window appears.

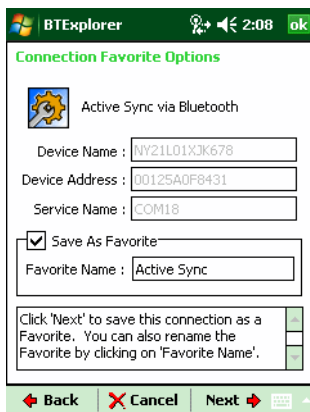

Figure 7-35 Remote Service Connection Window

5. In the **Service Type** drop-down list, select **Active Sync**.

6. Tap **OK**. The MC9500-K connects the PC and an ActiveSync session begins.
7. Tap **Finish**. The Connection Favorite Options window appears.
8. To end the session, tap the ActiveSync icon in the **Favorite** window and select **Disconnect** from the pop-up window.

Personal Area Network Services

✓ **NOTE** This profile supports Ad-hoc and PAN User. Network Access Profile is not supported.

Connect two or more Bluetooth devices to share files, collaborate, or play multi-player games. To establish a Personal Area Network connection:

1. Ensure that the **Personal Area Networking** profile is enabled on the MC9500-K. See [Profiles Tab on page 7-47](#) for more information.
2. Use the **Connection Wizard** to search for a Bluetooth device.
3. Select the device and tap **Next**. The **Connection Favorite Options** window appears.
4. Tap **Next**. The **Connection Summary** window appears.
5. Tap **Connect**. The MC9500-K connects to the Bluetooth device.

IrMC Synchronization Services

IrMC Synchronization is used to synchronize PIM contacts between a remote device and the MC9500-K. To establish an IrMC synchronization:

1. Ensure the MC9500-K is connectable (required when automatic re-connect is initiated). See [Device Info Tab on page 7-36](#).
2. Ensure that the **Sync** profile is enabled on the MC9500-K. See [Profiles Tab on page 7-47](#) for more information.
3. Tap **Menu > Settings > Services** tab.
4. Tap **Add** button.
5. Select **IrMC Synchronization**.
6. Tap **OK**. The **Edit Local Services** window appears.
7. Tap **OK** twice.
8. Use the **Connection Wizard** to search for a Bluetooth device, such as a Car Kit.
9. Select the device and tap **Next**. The **Connection Favorite Options** window appears.
10. Tap and hold **IrMA Synchronization** and select **Connect** in the pop-up menu.

✓ **NOTE** To automatically transfer contact with a Car Kit, ensure that the IrMC Synchronization service is enabled on the MC9500-K.

A2DP/AVRCP Services

A2DP/AVRCP is used to connect to a high-quality stereo headset:

1. Ensure the MC9500-K is connectable (required when automatic re-connect is initiated). See [Device Info Tab on page 7-36](#).
2. Ensure that the remote Bluetooth device is in discoverable mode. See the devices user manual for instructions.
3. Ensure that the **A2DP/AVRCP** profile is enabled on the MC9500-K. See [Profiles Tab on page 7-47](#) for more information.
4. Tap **Menu > Settings > Services** tab.
5. Tap **Add** button.
6. Select **Advanced Audio Distribution Services**.
7. Tap **OK**. The **Edit Local Services** window appears.
8. Tap **OK** twice.
9. Tap **Menu > New Connection**.
10. Select **Connect to High-Quality Audio** from the drop-down list.
11. Tap **Next**.
12. Select the device and tap **Next**.
13. Enter the PIN Code for the remote device and then tap **OK**. The **Connection Favorite Options** window appears.
14. Tap **Next**.
15. Tap **Connect**. The MC9500-K connects to the high-quality audio headset.

For stereo headsets that can use hands-free services, connect to the hands-free service after connecting to the A2DP service:

1. Tap **Menu > New Connection**.
2. Select **Connect to Headset** from the drop-down list.
3. Tap **Next**.
4. Select the stereo headset and tap **Next**.
5. Select the **Hands-Free unit** service and then tap **Next**.
6. Tap **Next**.
7. Tap **Connect**.

Connect to a HID Device

The MC9500-K can connect to an Human Interface Device (HID) device such as a Bluetooth keyboard:

1. Ensure the MC9500-K is connectable (required when automatic re-connect is initiated). See [Device Info Tab on page 7-36](#).
2. Ensure that the remote Bluetooth device is in discoverable mode. See the device user manual for instructions.
3. Ensure that the **HID Client** profile is enabled on the MC9500-K. See [Profiles Tab on page 7-47](#) for more information.

4. Tap **Menu > New Connection**.
5. Select **Explore Services on Remote Device** from the drop-down list.
6. Tap **Next**.
7. Select the device and tap **Next**.
8. Select the service and tap **Next**.
9. The **Connection Favorite Options** window appears.
10. Tap **Next**.
11. Tap **Connect**. The MC9500-K connects to the HID device.

Bonding with Discovered Device(s)

A bond is a relationship created between the MC9500-K and another Bluetooth device in order to exchange information in a secure manner. Creating a bond involves entering the same PIN on the two devices. After creating a bond and turning on the Bluetooth radios, the devices recognize the bond and can exchange information without re-entering a PIN.

To bond with a discovered Bluetooth device:

- ✓ **NOTE** If favorite connections have already been created, the **Favorites** screen displays. If no favorite connections have been created, the **New Connection Wizard** screen displays.

1. Tap the **Bluetooth** icon and select **Show BTE Explorer**. The **BTE Explorer** window appears.
2. Tap **Menu > New Connection**. The **New Connection Wizard** window appears.
3. In the drop-down list, select **Pair with Remote Device**.
4. Tap **Next**. The **Select Remote Device** window appears.

- ✓ **NOTE** Devices discovered previously are listed to save time. To start a new device discovery, tap and hold on the list area and select **Discover Devices** from the pop-up menu.



Figure 7-36 Select Remote Device Window

5. Select a device from the list and tap **Next**. The **PIN Code Request** window appears.

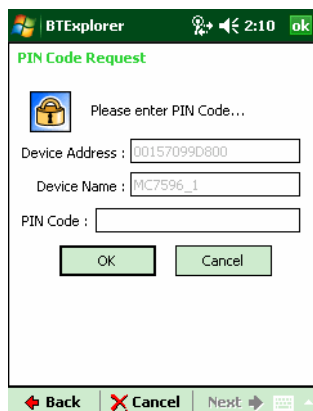

Figure 7-37 Connection Favorite Options Window

6. In the **PIN Code** field, enter the PIN code.
7. Tap **OK**. The **Pairing Status** window displays.

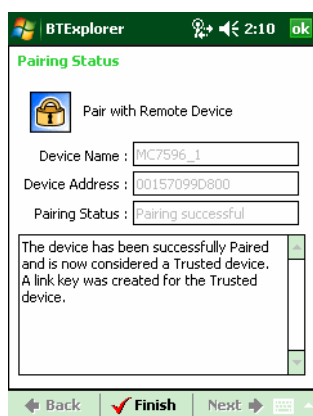

Figure 7-38 Pairing Status Window

8. Tap **Finish**. The devices are successfully paired. The device name moves to the **Trusted Devices** window.

Deleting a Bonded Device

To delete a device no longer needed:

1. Tap the **Bluetooth** icon and select **Show BTExplorer**. The **BTExplorer** window appears.
2. Tap **Menu > Trusted Devices**. The **Trusted Devices** window appears.
3. Tap and hold on the device select **Delete Link Key** in the pop-up menu.
4. A confirmation dialog appears. Tap **Yes**.

Accepting a Bond

When a remote device wants to bond with the MC9500-K, enter a PIN when requested to grant permission.

1. Ensure that the MC9500-K is set to discoverable and connectable. See [Bluetooth Settings on page 7-36](#). When prompted to bond with the remote device the **PIN Code Request** window appears.

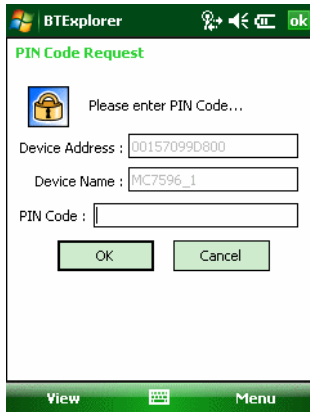

Figure 7-39 PIN Code Request Window

2. In the **PIN Code**: text box, enter the same PIN entered on the device requesting the bond. The PIN must be between 1 and 16 characters.
3. In the **Device Name**: text box, edit the name of the device requesting the bond, if desired.
4. Tap **OK** to create the bond. The MC9500-K can now exchange information with the other device.

Bluetooth Settings

Use the **BTE Explorer Settings** window to configure the operation of the **BTE Explorer** application. Tap **Menu > Settings**. The **BTE Explorer Settings** window appears.

Device Info Tab

Use the **Device Info** tab to configure the MC9500-K's Bluetooth connection modes.



Figure 7-40 BTE Explorer Settings - Device Info Tab

Table 7-3 Device Info Tab Data

Item	Description
Device Name	Displays the name of the MC9500-K.
Discoverable Mode	Select whether or not the MC9500-K is discoverable by other Bluetooth devices.
Connectable Mode	Select whether or not the MC9500-K is connectable by other Bluetooth devices.

Services Tab

- ✓ **NOTE** Ensure that the MC9500-K is discoverable and connectable when remote devices use MC9500-K services.

Use the **Services** tab to add or delete Bluetooth services.

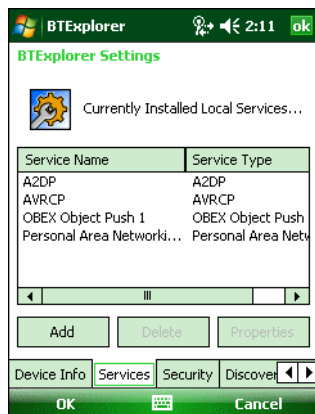

Figure 7-41 BTE Explorer Settings - Services Tab

To add a service:

1. Tap **Add**. The **Add Local Service** window displays.

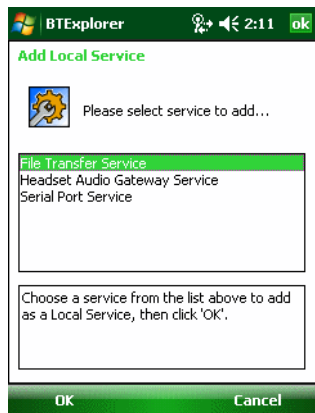

Figure 7-42 Add Local Service Window

2. In the list, select a service to add.
3. Tap **OK**. The **Edit Local Service** window displays for the selected service.
4. Select the appropriate information and then tap **OK**. See the following sections for information on the available services.

Dial-Up Networking Service

Dial-up Networking allows other Bluetooth devices to access a dial-up modem.

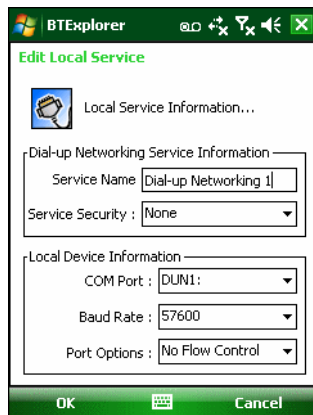

Figure 7-43 BTE Explorer Settings - Dial-up Networking Information

Table 7-4 Dial-up Networking Information Data

Item	Description
Service Name	Displays the name of the service.
Service Security	Select the type of security from the drop-down list. Options are None , Authenticate , or Authenticate/Encrypt .
Local COM Port	Select the COM port.
Local Baud Rate	Select the communication baud rate.
Local Port Options	Select the port option.

File Transfer Service

File transfer allows other Bluetooth devices to browse files.

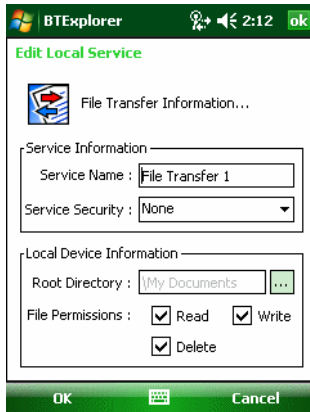

Figure 7-44 BTE Explorer Settings - File Transfer Information

Table 7-5 File Transfer Information Data

Item	Description
Service Name	Displays the name of the service.
Service Security	Select the type of security from the drop-down list. Options are None , Authenticate , or Authenticate/Encrypt .
Root Directory	Select the directory that other Bluetooth devices can access.
File Permissions	Select the file permissions for the selected directory. Check the appropriate box to grant read access, write access, and delete access.

Hands-Free Audio Gateway Service

Hands-Free Service Audio Gateway allows connection to hands-free devices.

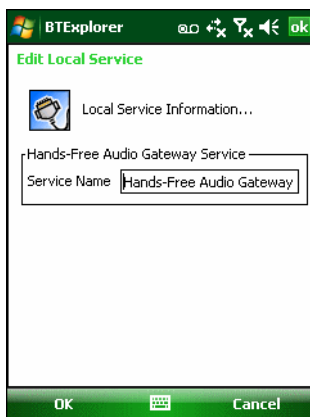

Figure 7-45 BTE Explorer Settings - Hands-Free Audio Gateway

Table 7-6 Hands-Free Audio Gateway Data

item	Description
Service Name	Lists the name of the audio service.

Headset Audio Gateway Service

Headset Service Audio Gateway allows connection to headset devices.



Figure 7-46 BTE Explorer Settings - Headset Audio Gateway

Table 7-7 Headset Audio Gateway Data

Item	Description
Service Name	Lists the name of the audio service.

IrMC Synchronization Service

The IrMC Synchronization service used to synchronize PIM contacts between a remote device and the MC9500-K.

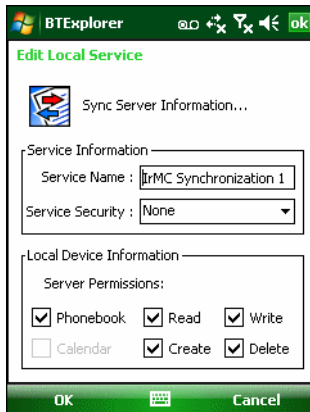

Figure 7-47 BTE Explorer Settings - IrMC Synchronization

Table 7-8 IrMC Synchronization Data

Item	Description
Service Name	Displays the name of the service.
Service Security	Select the type of security from the drop-down list. Options are None , Authenticate , or Authenticate/Encrypt .
Phonebook	Select the Phonebook checkbox to allow synchronization with the MC9500-K's contacts.
	Select Read , Write , Create and/or Delete to allow phonebook permissions.

OBEX Object Push Service

OBEX Object Push allows other Bluetooth devices to push contacts, business cards, pictures, appointments, and tasks to the MC9500-K.

**Figure 7-48** BTE Explorer Settings - OBEX Exchange Information**Table 7-9** OBEX Exchange Information Data

Item	Description
Service Name	Displays the name of the service.
Service Security	Select the type of security from the drop-down list. Options are None , Authenticate , or Authenticate/Encrypt .
Do not allow clients to push objects	Disables clients from pushing objects to the MC9500-K.
Inbox Directory	Select a directory where another Bluetooth device can store files.

Personal Area Networking Service

Personal Area Networking hosts a Personal Area Network which allows communication with other Bluetooth devices.

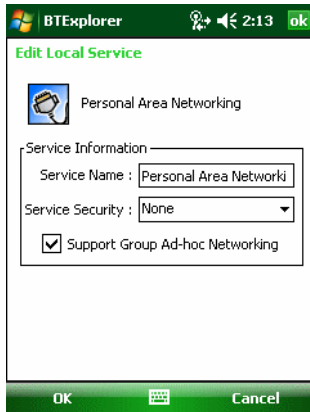

Figure 7-49 BTE Explorer Settings - Personal Area Networking

Table 7-10 Personal Area Networking Data

Item	Description
Service Name	Displays the name of the service.
Service Security	Select the type of security from the drop-down list. Options are None , Authenticate , or Authenticate/Encrypt .
Support Group Ad-Hoc Networking	Select to enable Ad-Hoc networking.

Serial Port Service

Serial port allows other Bluetooth devices to access COM ports.

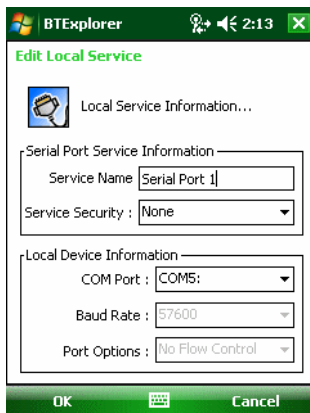

Figure 7-50 BTE Explorer Settings - Serial Port Services

Table 7-11 Serial Port Services Data

Item	Description
Service Name	Displays the name of the service.
Service Security	Select the type of security from the drop-down list. Options are None , Authenticate , or Authenticate/Encrypt .
Local COM Port	Select the COM port.
Local Baud Rate	Select the communication baud rate.
Local Port Options	Select the port option.

Advanced Audio Distribution Service

Advanced Audio Distribution hosts connects from Bluetooth devices supporting high-quality stereo audio.

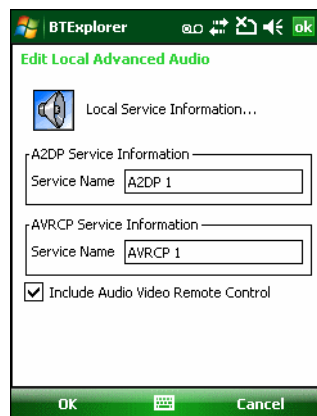
**Figure 7-51** BTE Explorer Settings - Advanced Audio Distribution**Table 7-12** Advanced Audio Distribution Data

Item	Description
Service Name	Lists the name of the audio service.

Audio Video Remote Control Service

Audio Video Remote Control hosts connections from Bluetooth devices supporting audio remote-control functionality.

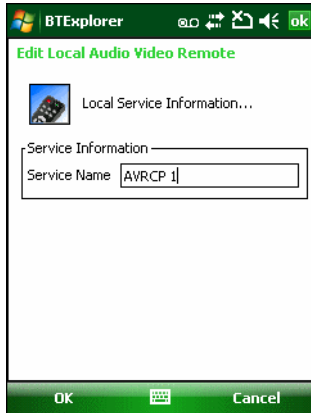

Figure 7-52 BTE Explorer Settings - Audio Video Remote Control

Table 7-13 Audio Video Remote Control Data

Item	Description
Service Name	Lists the name of the audio service.

Security Tab

Security settings allows you to set global security policies for Bluetooth. Note that these settings are only active on local Services that are set to Authenticate or Authenticate/Encryption. You can set authentication on local Services under the Services tab.

To adjust the security settings for an individual service, select the **Services** tab first, then select the individual service, then **Properties**.

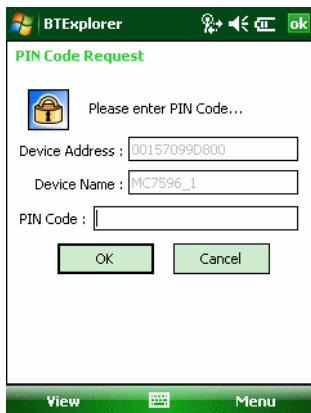

Figure 7-53 BTE Explorer Settings - Security Tab



NOTE To use PIN Code, select **Authenticate** or **Authenticate/Encrypt** from the Service Security drop-down list on each local service.

Table 7-14 Security Tab Data

Item	Description
Use PIN Code (Incoming Connection)	Select for automatic use of the PIN code entered in the PIN Code text box. It is recommended not to use this automatic PIN code feature. See Security on page 7-2 for more information.
PIN Code	Enter the PIN code.
Encrypt Link On All Outgoing Connections	Select to enable or disable encryption on all outgoing connections to other Bluetooth devices.

Discovery Tab

Use the **Discovery** tab to set and modify discovered devices.

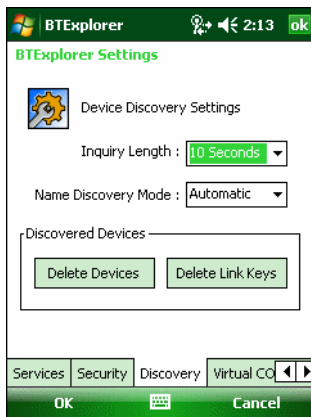
**Figure 7-54** BTE Explorer Settings - Discovery Tab**Table 7-15** Discovery Tab Data

Item	Description
Inquiry Length	Sets the amount of time the MC9500-K takes to discover Bluetooth devices in the area.
Name Discovery Mode	Select either Automatic or Manual to automatically attempt to discover a Bluetooth device's name after finding the device.
Discovered Devices - Delete Devices	Deletes all discovered devices and link keys from memory.
Discovered Devices - Delete Linked Keys	Removes all pairing from remote Bluetooth devices, and makes them all un-trusted.

Virtual COM Port Tab

Virtual COM Port defines which COM ports BTE Explorer attempts to use for virtual COM ports. Check the appropriate checkbox to use the port as a virtual COM port. When finished, choose **Apply** to enforce changes, or **Revert** to restore the original settings.

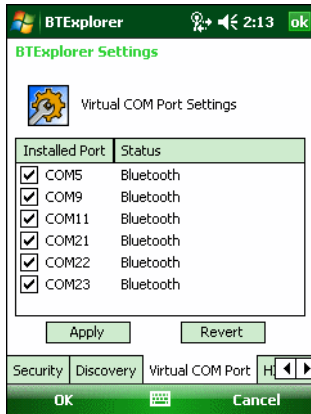

Figure 7-55 BTE Explorer Settings - Virtual COM Port Tab

Table 7-16 Virtual COM Port Tab Data

Item	Description
COM5:Bluetooth	Enable or disable COM Port 5.
COM9:Bluetooth	Enable or disable COM Port 9.
COM11:Bluetooth	Enable or disable COM Port 11.
COM21:Bluetooth	Enable or disable COM Port 21.
COM22:Bluetooth	Enable or disable COM Port 22.
COM23:Bluetooth	Enable or disable COM Port 23.

HID Tab

Use the **HID** tab to select The Human Interface Device Profile programming interface defines the protocols and procedures to be used to implement HID capabilities.

Provides support for devices such as mice, joysticks, keyboards.

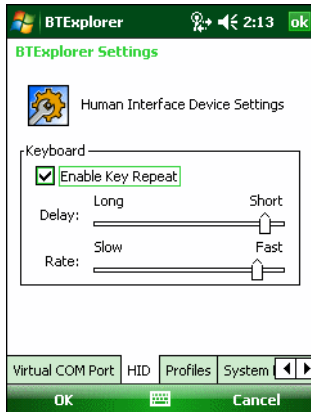

Figure 7-56 BTE Explorer Settings - HID Tab

Table 7-17 HID Tab Data

Item	Description
Enable Key Repeat	Enables key repeat functionality.
Delay	To increase key repeat delay, drag the Delay slider to the right. To decrease key repeat delay, drag the Delay slider to the left.
Rate	To increase key repeat speed, drag the Rate slider to the left. To decrease key repeat speed, drag the Rate slider to the right.

Profiles Tab

Use the **Profile** tab to load or remove Bluetooth services profiles. If a profile is not used, it can be removed to save memory.

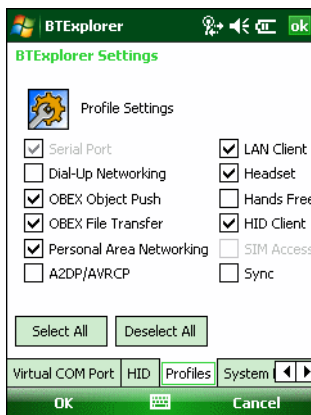

Figure 7-57 BTE Explorer Settings - Profile Tab

1. Tap a check box next to the profile to load (activate).
The Serial Port profile is always active and cannot be removed.
2. Tap **Select All** to select all profiles or tap **Deselect All** to deselect all profiles.
3. Tap **Apply** to activate the profiles and then **Close** to exit the application.

System Parameters Tab

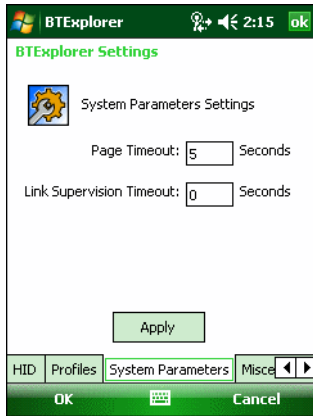

Figure 7-58 BTE Explorer Settings - System Parameters Tab

Table 7-18 System Parameters Tab Data

item	Description
Page Timeout	Sets the amount of time the MC9500-K searches for a device before moving on the next device.
Link Supervision Timeout	Sets the amount of time that the MC9500-K will wait for a device to come back into range after it has gone out of range. If the device does not come back into range by the set time, the MC9500-K drops the connection.

Miscellaneous Tab

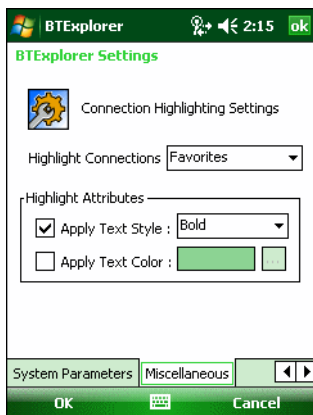

Figure 7-59 BTE Explorer Settings - Miscellaneous Tab

Table 7-19 *Miscellaneous tab Data*

Item	Description
Highlight Connections	Select the connection type to highlight when connected. In the Wizard Mode, the only options are <i>Favorites</i> or <i>None</i> . In the Explorer Mode the options are None , Tree View Only , List View Only , or Tree and List View .
Apply Text Style	Select the text style to apply to the connection text.
Apply Text Color	Select the text color to apply to the connection text.

Chapter 8 Accessories

Introduction

[Table 8-1](#) lists the accessories available for the MC9500-K Series mobile computer.

Table 8-1 MC9500-K Series Accessories

Accessory	Part Number	Description
Cradles		
Single Bay USB Cradle	CRD9500-1000UR	Charges the MC9500-K main battery. Synchronizes the MC9500-K with a host computer through a USB connection.
Four Bay Charge Only Cradle	CRD9500-4000CR	Charges up to four MC9500-K devices.
Four Bay Ethernet Cradle	CRD9500-4000ER	Charges up to four MC9500-K devices and connects the MC9500-K with an Ethernet network.
Vehicle Cradle	VCD9500-1000R	Installs in a vehicle and charges the MC9500-K main battery.
Chargers		
Single Slot Battery Charger	SAC9500-1000CR	Charges one MC9500-K battery.
Four Slot Battery Charger	SAC9500-4000CR	Charges up to four MC9500-K batteries.
Vehicle Battery Charger	VBC9500-1000R	Charges one MC9500-K battery in a vehicle.
Miscellaneous		
Modem Dongle	MDM9000-100R	Provides modem connectivity for the MC9500-K.
Magnetic Stripe Reader	MSR9500-100R	Snaps onto the MC9500-K and adds magstripe read capabilities.
Spare 4800 mAh lithium-ion battery	BTRY-MC951ABA0 BTRY-MC951ABA0-10	Replacement 4800 mAh battery. Replacement 4800 mAh battery (10-pack).

Table 8-1 MC9500-K Series Accessories (Continued)

Accessory	Part Number	Description
Belt Mounted Rigid Holster	SG-MC9511110-01R	Clips onto belt to hold the MC9500-K when not in use.
Fabric Holster	SG-MC9521110-01R	Soft holder for added protection.
Handstrap	SG-MC9523043-01R	Replacement handstrap (5-pack).
Cradle Guides	KT-122014-01R	Provides assistance for placing an MC9500-K onto a four bay cradle (4-pack).
Screen Protector	KT-122010-01R	Package of 3 screen protectors.
Spare Stylus, 3 Pack	KT-122016-03R	Replacement stylus (3-pack).
Spare Stylus, 50 Pack	KT-122018-50R	Replacement stylus (50-pack).
Power Supply	KT-14000-148R	Supports the Single Bay USB Cradle, Single Slot Battery Charger and Four Slot Battery Charger.
Power Supply	50-14000-241R	Supports one Four Bay cradle or up to four (4) Four Slot Battery Chargers.
Cables		
USB/Charge Cable	25-116365-01R	Provides power to the MC9500-K and USB communication with a host computer.
Auto Charge Cable	VCA9500-01R	Charges the MC9500-K using a vehicle's cigarette lighter.
DEX Cable	25-116366-01R	Connects the MC9500-K to a vendor machine.
4-way DC cable	25-85992-01R	Used to power up to four Four Slot Battery Chargers with one power supply (50-14000-241R).
USB Sync Cable	25-124330-01R	micro USB Client Communication Cable connects Single Bay USB Cradle to the host system (micro USB B to USB A).
Single Bay USB Cradle/Charger Y-Cable	25-122026-01R	Connect the Single Bay USB cradle and a Single Slot Battery Charger to a single power supply.
Modem Adapter Cable	25-116367-01R	Connect the MC9500-K to the Modem Dongle.
Headset Adapter Cable	21-116368-01R	Connects a VX1 headset to the MC9500-K.
AC Line Cord	23844-00-00R	Connects a power supply to an outlet (US only).
DC Cable	50-16002-029R	Connects from the four bay cradle to a power supply.
Vehicle Battery Charger Cable	25-122028-01R	This 'jumper' cable connects the vehicle battery charger to the vehicle cradle.
Brackets		
Desk Mounting Bracket	KT-116363-01R	Use for mounting a four bay cradle or two four slot battery chargers on a desk.
Universal Wall Mounting Bracket	KT-116362-01R	Use for mounting a four bay cradle or two four slot battery chargers on a wall.

Table 8-1 MC9500-K Series Accessories (Continued)

Accessory	Part Number	Description
Vehicle Mounting Bracket	KT-122012-01R	Used for mounting the vehicle cradle and vehicle battery charger in a vehicle.
Four Slot Battery Charger Desk Mount Bracket	KT-116364-01R	Used for mounting the Four Slot battery Charger on a desktop.

Universal Accessory System

The Motorola Universal Accessory System is a portfolio of accessories that can be easily configured and re-configured when the need arises. The system consists of cradles, chargers, power supplies, cables and mounting brackets.

Single Bay USB Cradle

This section describes how to use a Single Bay USB cradle with the MC9500-K. For power and USB communication setup procedures refer to the *MC9500-K Series Mobile Computer Integrator Guide*.

The Single Bay USB Cradle:

- Provides 5.4 VDC power for operating the MC9500-K.
- Synchronizes information between the MC9500-K and a host computer. Refer to the *MC9500-K Mobile Computer Integrator Guide* for information on setting up a partnership between the MC9500-K and a host computer.
- Charges the MC9500-K's battery.

Communication and Charging the MC9500-K Battery

To charge the MC9500-K battery and to communicate with a host computer:

1. Ensure that the cradle is connected to power and to a host computer.
2. Align and hook the MC9500-K interface pocket onto the cradle's cleat.

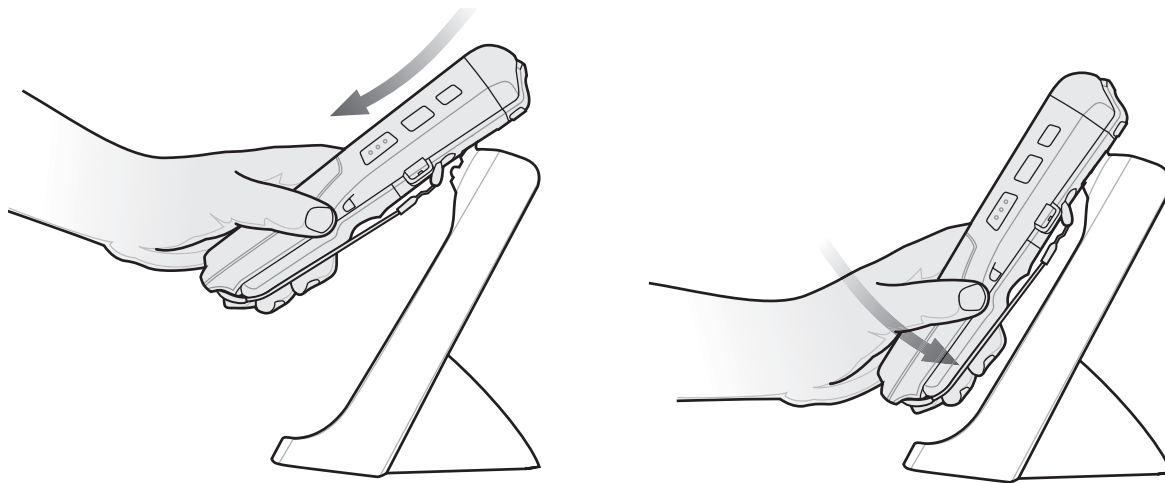

Figure 8-1 Hooking the MC9500-K onto the Single Bay USB Cradle

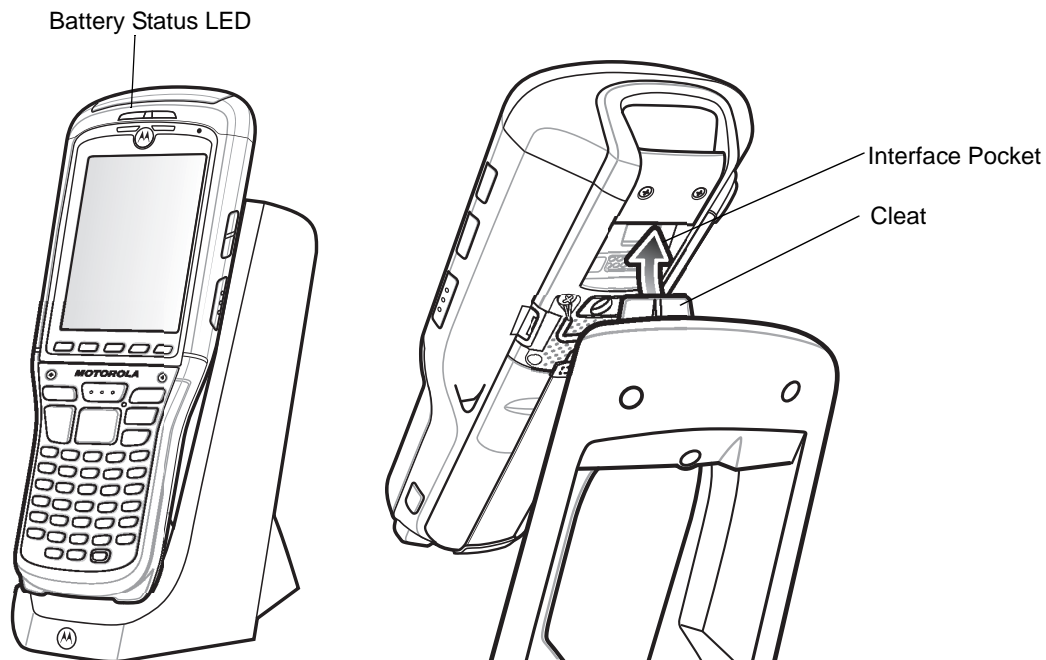

Figure 8-2 MC9500-K Battery Charging

The MC9500-K's Battery Status LED indicates the status of the battery charging in the MC9500-K. See [Table 2-6 on page 2-7](#) for charging status indications. The 4800 mAh battery fully charges in less than six hours.

Single Slot Battery Charger

This section describes how to use a Single Slot Battery Charger.

Charging the Battery

To charge a spare battery:

1. Ensure that the charger is connected to power.
2. Insert the spare battery into the slot to begin charging.

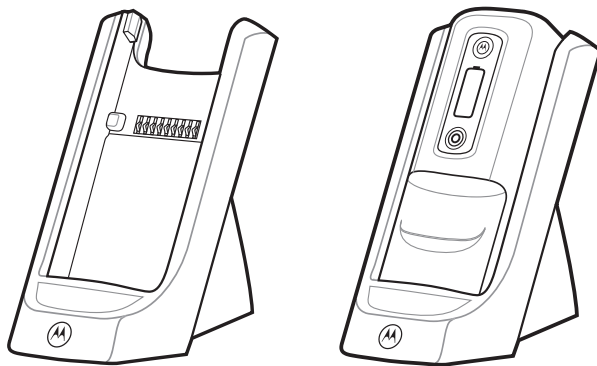

Figure 8-3 Single Slot Spare Battery Charging

The charging status is indicated on the front of the battery. See [Table 2-7 on page 2-8](#) for charging status indications. The 4800 mAh battery fully charges in less than six hours.

Four Bay Charge Only Cradle

This section describes how to use a Four Bay Charge Only cradle with the MC9500-K.

The Four Bay Charge Only cradle:

- Provides 5.4 VDC power for operating the MC9500-K.
- Simultaneously charges up to four MC9500-K devices.
- Mounts on a wall or desktop using the appropriate mounting bracket.

Charging

To charge the MC9500-K:

1. Ensure that the cradle is connected to power.
2. Align and hook the MC9500-K interface pocket onto the cradle's cleat. Optional guide cups can be used to assist in placement of the MC9500-K onto the cradle.

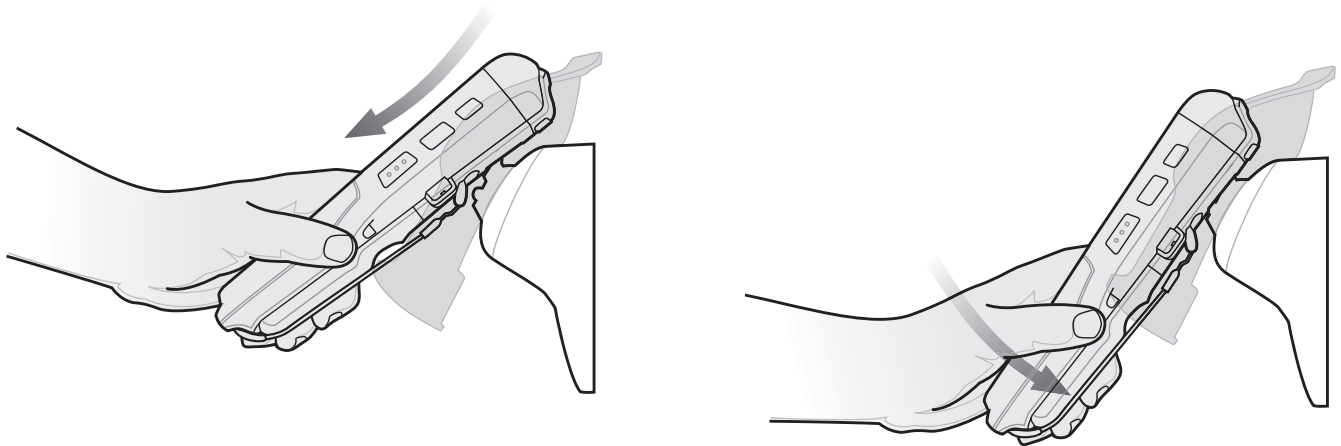

Figure 8-4 *Hooking the MC9500-K onto a Four Slot Cradle*

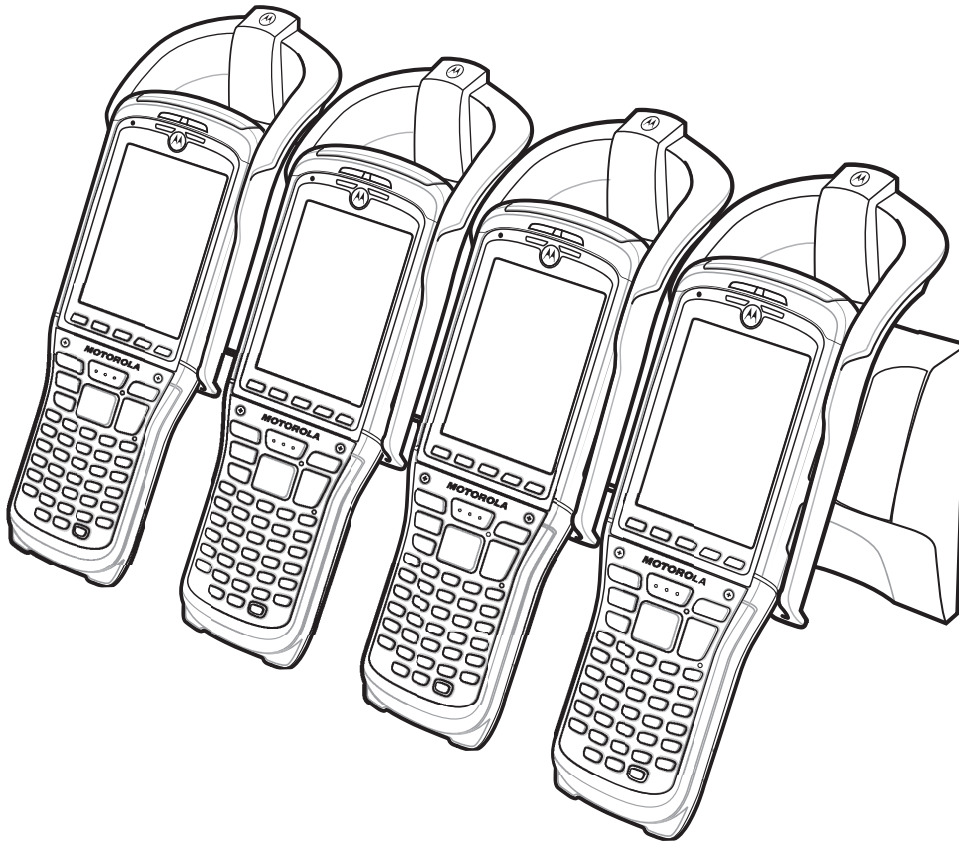

Figure 8-5 MC9500-K Four Bay Charge Only Cradle with Optional Guide Cups

The MC9500-K's Battery Status LED shows the status of the battery charging in the MC9500-K. See [Table 1-1 on page 1-7](#) for charging status indications. The 4800 mAh battery fully charges in less than six hours.

Four Bay Ethernet Cradle

This section describes how to use a Four Bay Ethernet cradle with the MC9500-K. For setup and cradle communication setup procedures refer to the *MC9500-K Mobile Computer Integrator Guide*.

The Four Bay Ethernet cradle:

- Provides 5.4 VDC power for operating the MC9500-K.
- Connects up to four MC9500-K devices to an Ethernet network.
- Simultaneously charges up to four MC9500-K devices.
- Mounts on a wall or desktop using the appropriate mounting bracket.

Communication and Charging

To charge the MC9500-K battery and communicate with a host computer:

1. Ensure that the cradle is connected to power and an Ethernet hub.
2. Align and hook the MC9500-K interface pocket onto the cradle's cleat. If available, use the guide to assist in placement of the MC9500-K onto the cradle. See [Figure 8-4 on page 8-7](#).

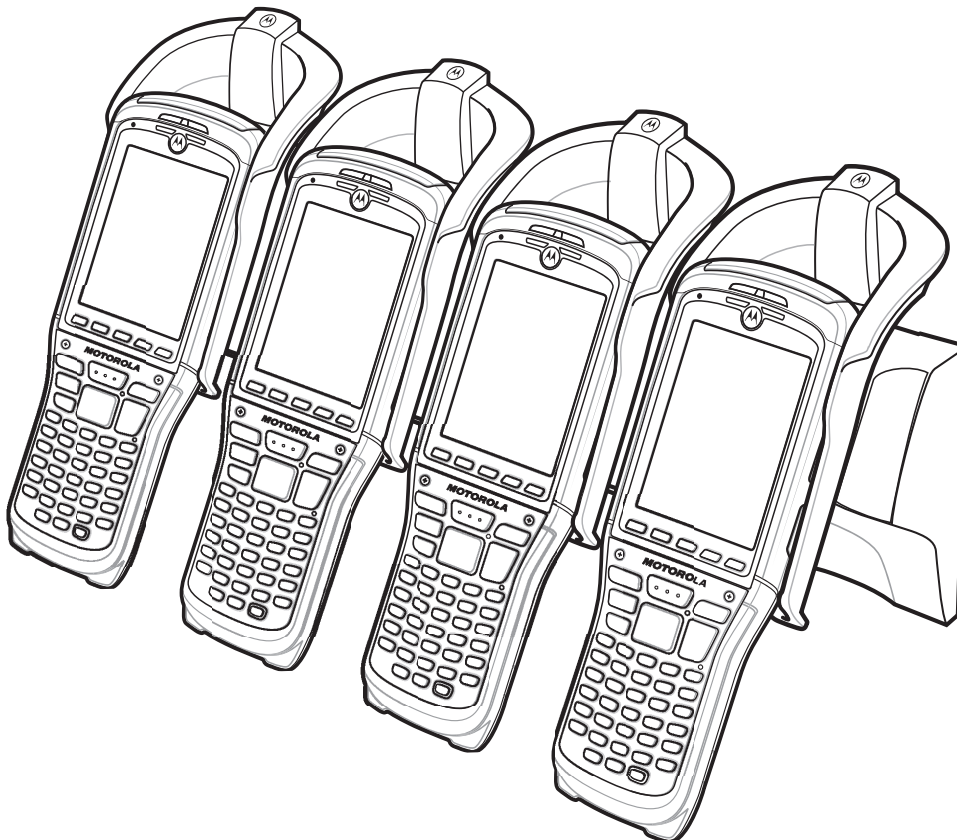

Figure 8-6 Four Bay Ethernet Cradle with Optional Guide Cups

The MC9500-K's Battery Status LED shows the status of the battery charging in the MC9500-K. See [Table 1-1 on page 1-7](#) for charging status indications. The 4800 mAh battery fully charges in less than six hours.

LED Indicators

Speed LED

The cradle's green Speed LED lights to indicate that the transfer rate is 100 Mbps. When it is not lit it indicates that the transfer rate is 10Mbps.

Link LED

The cradle's yellow Link LED blinks to indicate activity, or stays lit to indicate that a link is established. When it is not lit it indicates there is no link.

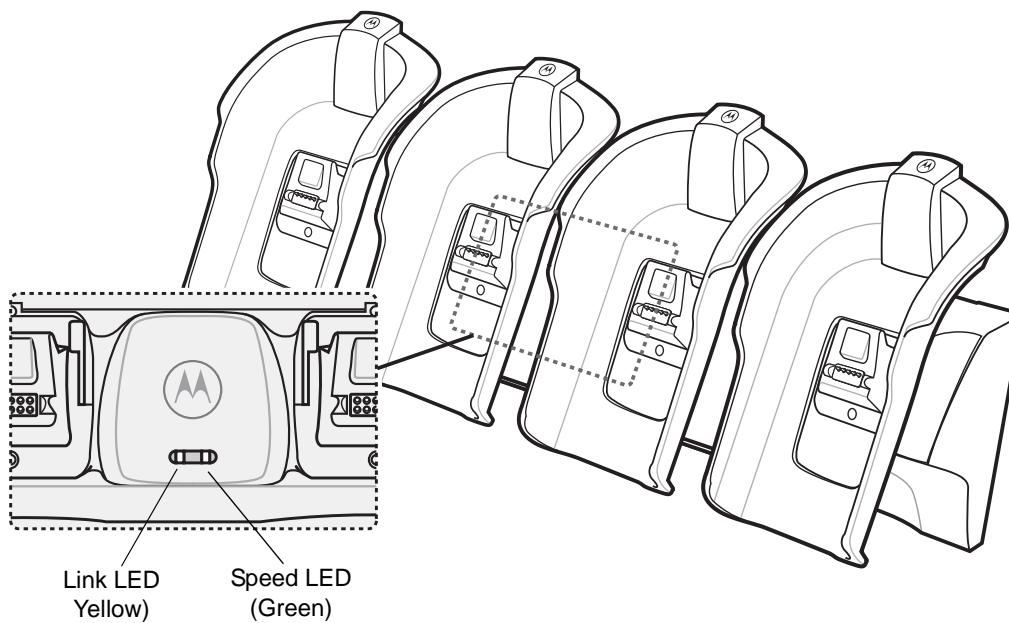

Figure 8-7 Four Slot Ethernet Cradle LED Indications

Four Slot Battery Charger

This section describes how to use the Four Slot Battery Charger.

The Four Slot Battery Charger:

- Simultaneously charges up to four MC9500-K batteries.
- Mounts on a wall or desk using the appropriate mounting bracket.

Battery Charging

To charge a battery:

1. Ensure that the charger is connected to power.
2. Insert a battery into a battery charging slot and gently press the battery into the slot to ensure proper contact.

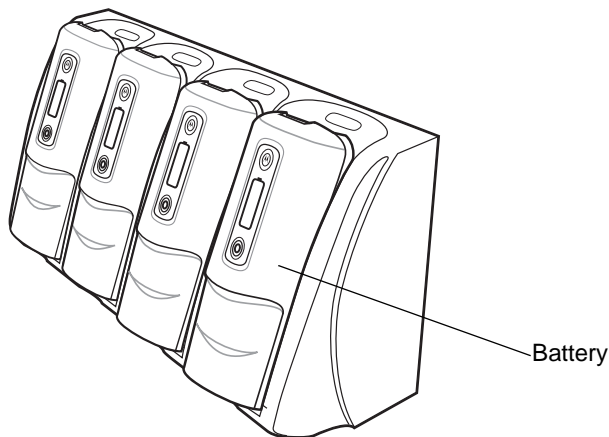

Figure 8-8 *Four Slot Battery Charger*

The charging status is indicated on the front of the battery. See [Table 2-7 on page 2-8](#) for charging status indications. The 4800 mAh battery fully charges in less than six hours.

Vehicle Cradle

This section describes how to use a vehicle cradle with the MC9500-K. For cradle installation and communication setup procedures refer to the *VCD9500 Vehicle Cradle Quick Reference Guide*.

Once installed in a vehicle, the cradle:

- holds the MC9500-K securely in place
- provides power for operating the MC9500-K
- re-charges the battery in the MC9500-K.

Charging the MC9500-K Battery

Insert the MC9500-K into the vehicle cradle with the display facing out.

Push back the level forward to lock the MC9500-K into place. The MC9500-K automatically begins charging.

✓ **NOTE** The MC9500-K will not begin charging unless the side level is locked into place.

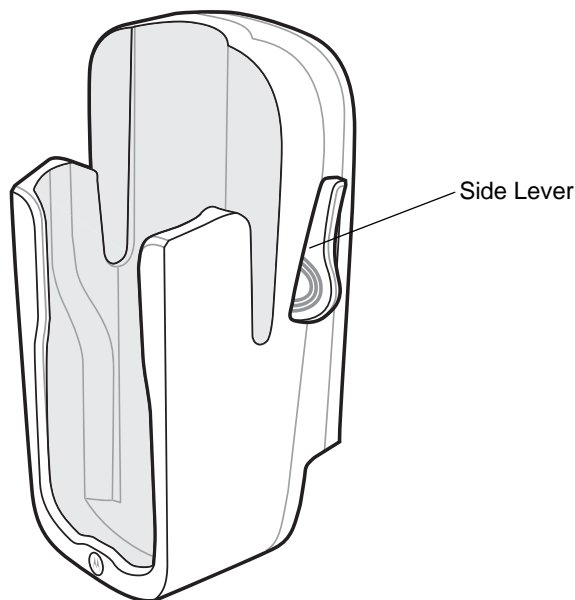



Figure 8-9 Vehicle Cradle

 **CAUTION** Ensure the MC9500-K is fully inserted in the cradle. Lack of proper insertion may result in property damage or personal injury. Motorola is not responsible for any loss resulting from the use of the products while driving.

To remove the MC9500-K, push the side levers toward the back of the Vehicle cradle. Lift the MC9500-K out of the cradle.

The MC9500-K's Battery Status LED indicates the status of the battery charging in the MC9500-K. See [Table 1-1 on page 1-7](#) for charging status indications. The 4800 mAh battery fully charges in less than six hours.

Vehicle Battery Charger

This section describes how to use the Vehicle Battery Charger.

Charging the Battery

To charge a spare battery:

1. Ensure that the charger is connected to power.
2. Insert the spare battery into the slot to begin charging.

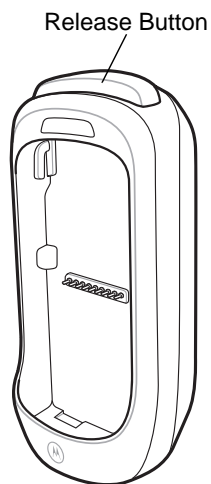

Figure 8-10 Vehicle Battery Charger

The charging status is indicated on the front of the battery. See [Table 2-7 on page 2-8](#) for charging status indications. The 4800 mAh battery fully charges in less than six hours.

To remove the battery, press the release button. The battery ejects from the charger.

Magnetic Stripe Reader

This section describes how to set up and use the snap-on (Magnetic Stripe Reader (MSR)) with the MC9500-K. The MSR snaps on to the back of the MC9500-K and removes easily when not in use.

When attached to the MC9500-K, the MSR allows the MC9500-K to capture data from magnetic stripe cards. To download sample MSR data capture software, visit the Support Central web site.

To charge to MC9500-K with the MSR attached,

- ✓ **NOTE** While the MC9500-K with MSR is attached to a Single Bay USB Cradle, a Four Bay Ethernet Cradle or a USB/Charging Cable, Operation of the MSR is disabled.

If attaching the MC9500-K with the MSR onto a Four Bay Cradle, remove the optional guide cup before attaching the MC9500-K.

Attaching and Removing the MSR

To attach, slide the cleat of the MSR into the interface pocket of the MC9500-K and snap into place.

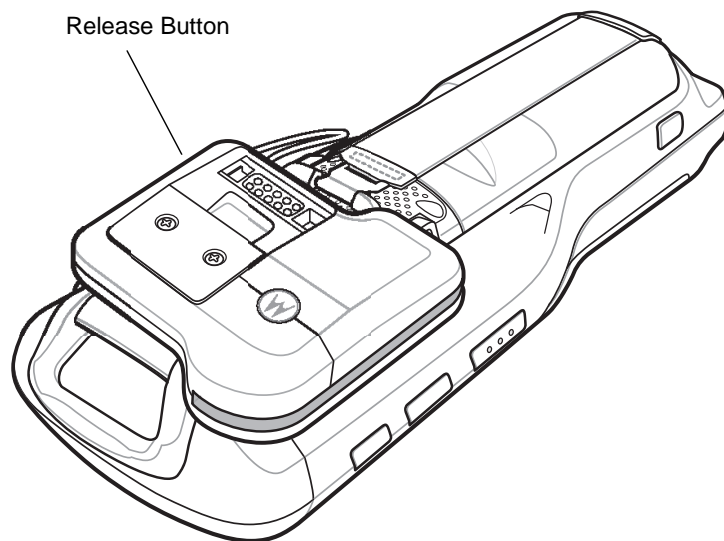

Figure 8-11 MSR Installation

To remove the MSR, press the release button and lift off the MC9500-K.

Using the MSR

Install an MSR enabled application onto the MC9500-K.

To use the MSR:

1. Attach the MSR to the MC9500-K.
2. Power on the MC9500-K.
3. Launch the MSR application.

4. Swipe the magnetic stripe card through the MSR, with the magnetic stripe on the card facing away from the MC9500-K. Swipe the card in either direction, up and down or down and up. For best results, gently press the card against the back of the MSR while swiping to ensure contact with the reader.

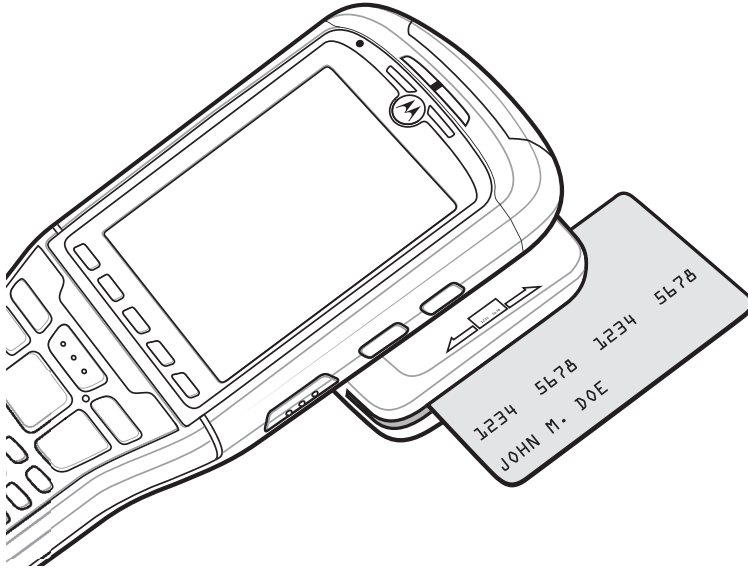

Figure 8-12 *Swipe Card through MSR*

5. The application indicates if the data has been read correctly.

Cables

This section describes how to set up and use the cables. The cables are available with a variety of connection capabilities.

The following communication/charge cables are available:

- USB/Charge cable
 - Provide the MC9500-K with operating and charging power when used with the Motorola approved power supply.
 - Synchronize information between the MC9500-K and a host computer. With customized or third party software, it can also synchronize the MC9500-K with corporate databases.

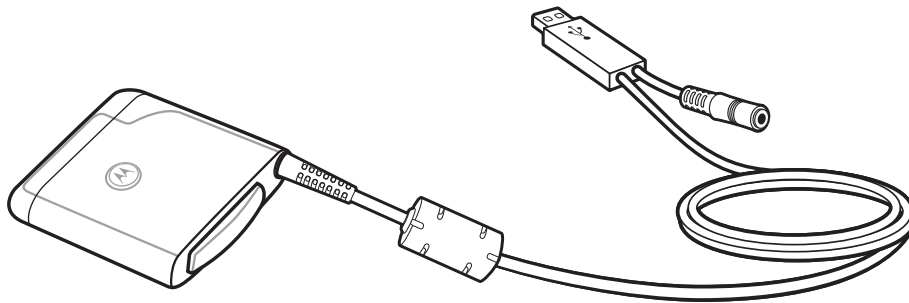

Figure 8-13 USB/Charge Cable

- Charge Only cable
 - Provide the MC9500-K with operating and charging power when used with the Motorola approved power supply.
- Single Bay Cradle/Charger Y Cable
 - Provide the power to a Single Bay USB Cradle and Single Slot Battery Charger or two Single Slot Battery Chargers off one power supply when used with the Motorola approved power supply.

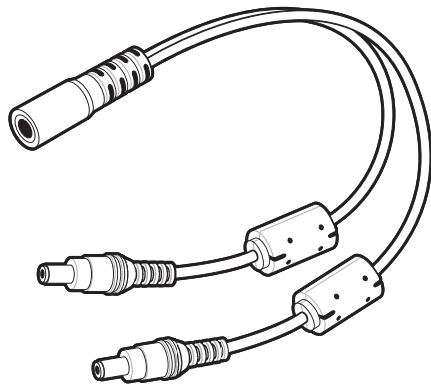

Figure 8-14 Single Slot Cradle/Charger Y-Cable

- Auto Charge cable.
 - Provides the MC9500-K or Vehicle Battery Charger with operating and charging power through a cigarette lighter.

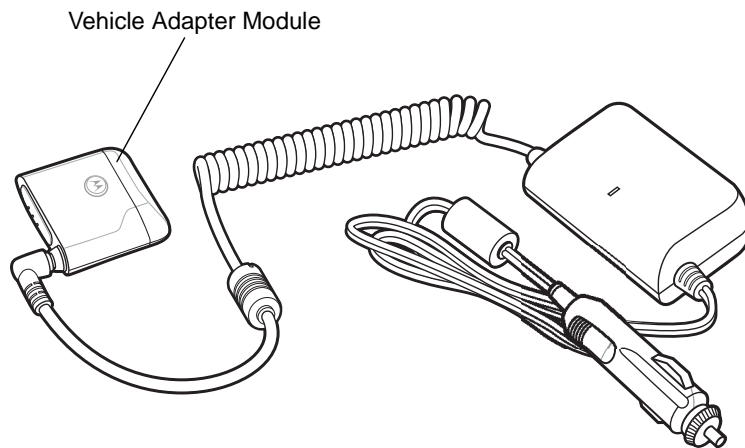

Figure 8-15 Auto Charge Cable

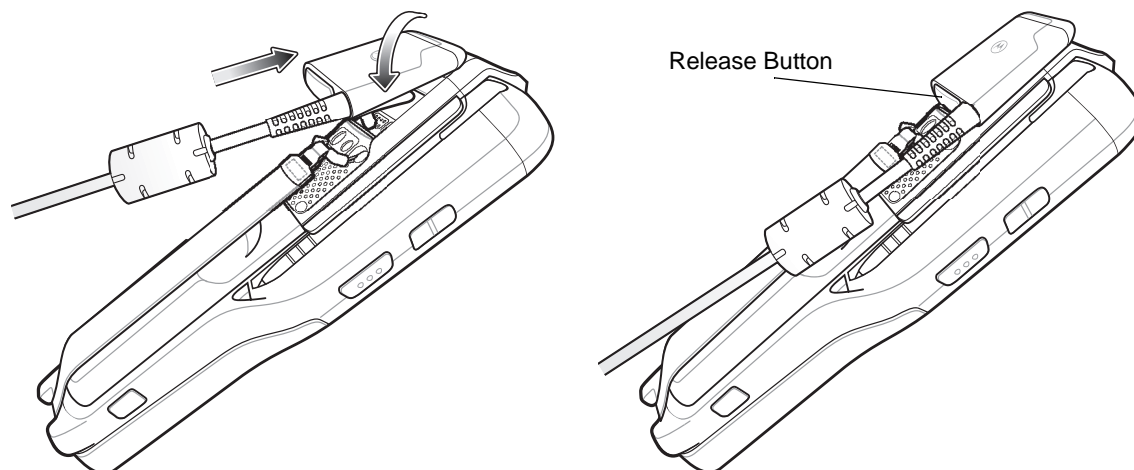

Figure 8-16 Cable Installation

Battery Charging and Operating Power

The communication/charge cables can charge the MC9500-K battery and supply operating power.

To charge the MC9500-K battery:

1. Connect the cable power input connector to the Motorola approved power source.
2. Align the cleat on the cable with the interface pocket on the back of the MC9500-K.

The MC9500-K amber Battery Status LED indicates the MC9500-K battery charging status. The 4800 mAh battery charges in less than six hours. See [Table 1-1 on page 1-7](#) for charging status indications.

3. When charging is complete, press the release button up and remove the cable from the MC9500-K.

Chapter 9 Maintenance & Troubleshooting

Introduction

This chapter includes instructions on cleaning and storing the MC9500-K, and provides troubleshooting solutions for potential problems during MC9500-K operation.

Maintaining the MC9500-K

For trouble-free service, observe the following tips when using the MC9500-K:

- Do not scratch the screen of the MC9500-K. When working with the MC9500-K, use the supplied stylus or plastic-tipped pens intended for use with a touch-sensitive screen. Never use an actual pen or pencil or other sharp object on the surface of the MC9500-K screen.

Motorola recommends using a screen protector, p/n KT-122010-01R.

- The touch-sensitive screen of the MC9500-K is polycarbonate. Do not drop the MC9500-K or subject it to strong impact.
- Protect the MC9500-K from temperature extremes. Do not leave it on the dashboard of a car on a hot day, and keep it away from heat sources.
- Do not store the MC9500-K in any location that is dusty, damp or wet.
- Use a soft lens cloth to clean the MC9500-K. If the surface of the MC9500-K screen becomes soiled, clean it with a soft cloth moistened with a diluted window-cleaning solution.
- Periodically replace the rechargeable battery to ensure maximum battery life and product performance. Battery life depends on individual usage patterns. The battery provides health status to assist in determining useful battery life. See [Chapter 2, Battery Management](#) for more information.
- Do not scratch the exit window. Clean the window periodically. Dust, contamination, and scratches on the exit window can cause visible blemishes in the images captured with the Imager.

- A screen protector is applied to the MC9500-K. Motorola recommends using this to minimize wear and tear. Screen protectors enhance the usability and durability of touch screen displays. Benefits include:
 - Protection from scratches and gouges
 - Durable writing and touch surface with tactile feel
 - Abrasion and chemical resistance
 - Glare reduction
 - Keeping the device's screen looking new
 - Quick and easy installation.

Removing the Screen Protector

A screen protector is applied to the MC9500-K. Motorola recommends using this to minimize wear and tear. Screen protectors enhance the usability and durability of touch screen displays.

To remove the screen protector, lift the corner using a thin plastic card, such as a credit card, then carefully lift it off the display.



Figure 9-1 *Removing the Screen Protector*



CAUTION Do not use a sharp object to remove the protector. Doing so can damage the display.



NOTE Not using a screen protector can affect warranty coverage. To purchase replacement protectors, contact your local account manager or Motorola, Inc. These include screen protector installation instructions. Part number: KT-122010-01R Screen Protector 3/pk.

Battery Safety Guidelines

- The area in which the units are charged should be clear of debris and combustible materials or chemicals. Particular care should be taken where the device is charged in a non commercial environment.
- Follow battery usage, storage, and charging guidelines found in the user's guide.
- Improper battery use may result in a fire, explosion, or other hazard.

- To charge the mobile device battery, the battery and charger temperatures must be between +32 °F and +104 °F (0 °C and +40 °C)
- Do not use incompatible batteries and chargers. Use of an incompatible battery or charger may present a risk of fire, explosion, leakage, or other hazard. If you have any questions about the compatibility of a battery or a charger, contact Motorola Enterprise Mobility support.
- For devices that utilize a USB port as a charging source, the device shall only be connected to products that bear the USB-IF logo or have completed the USB-IF compliance program.
- To enable authentication of an approved battery, as required by IEEE1725 clause 10.2.1, all batteries will carry a Motorola hologram. Do not fit any battery without checking it has the Motorola authentication hologram.
- Do not disassemble or open, crush, bend or deform, puncture, or shred.
- Severe impact from dropping any battery-operated device on a hard surface could cause the battery to overheat.
- Do not short circuit a battery or allow metallic or conductive objects to contact the battery terminals.
- Do not modify or remanufacture, attempt to insert foreign objects into the battery, immerse or expose to water or other liquids, or expose to fire, explosion, or other hazard.
- Do not leave or store the equipment in or near areas that might get very hot, such as in a parked vehicle or near a radiator or other heat source. Do not place battery into a microwave oven or dryer.
- Battery usage by children should be supervised.
- Please follow local regulations to properly dispose of used re-chargeable batteries.
- Do not dispose of batteries in fire.
- In the event of a battery leak, do not allow the liquid to come in contact with the skin or eyes. If contact has been made, wash the affected area with large amounts of water and seek medical advice.
- If you suspect damage to your equipment or battery, contact Motorola Enterprise Mobility support to arrange for inspection.

Cleaning



CAUTION Always wear eye protection.

Read warning label on compressed air and alcohol product before using.

If you have to use any other solution for medical reasons please contact Motorola for more information.



WARNING! Avoid exposing this product to contact with hot oil or other flammable liquids. If such exposure occurs, unplug the device and clean the product immediately in accordance with these guidelines.

Materials Required

- Alcohol wipes
- Lens tissue
- Cotton tipped applicators

- Isopropyl alcohol
- Can of compressed air with a tube.

Cleaning the MC9500-K

Housing

Using the alcohol wipes, wipe the housing including keys and in-between keys.

Display

The display can be wiped down with the alcohol wipes, but care should be taken not to allow any pooling of liquid around the edges of the display. Immediately dry the display with a soft, non-abrasive cloth to prevent streaking.

Scanner Exit Window

Wipe the scanner exit window periodically with a lens tissue or other material suitable for cleaning optical material such as eyeglasses.

Interface Connector

1. Remove the battery from MC9500-K. See [Replacing the Battery on page 1-8](#).
2. Dip the cotton portion of the cotton tipped applicator in isopropyl alcohol.
3. Rub the cotton portion of the cotton tipped applicator back-and-forth across the interface connector on the back of the MC9500-K. Do not leave any cotton residue on the connector.
4. Repeat at least three times.
5. Use the cotton tipped applicator dipped in alcohol to remove any grease and dirt near the connector area.
6. Use a dry cotton tipped applicator and repeat steps 3 through 5.
7. Spray compressed air on the connector area by pointing the tube/nozzle about ½ inch away from the surface. CAUTION: Do not point nozzle at yourself and others, ensure the nozzle or tube is away from your face.
8. Inspect the area for any grease or dirt, repeat if required.
9. Replace the battery.

Battery Contacts

1. Remove the battery from MC9500-K. See [Replacing the Battery on page 1-8](#).
2. Dip the cotton portion of the cotton tipped applicator in isopropyl alcohol.
3. Rub the cotton portion of the cotton tipped applicator back-and-forth across the battery contacts on the back of the battery. Do not leave any cotton residue on the contacts.
4. Repeat at least three times.
5. Use the cotton tipped applicator dipped in alcohol to remove any grease and dirt near the contact area.
6. Use a dry cotton tipped applicator and repeat steps 3 through 5.
7. Spray compressed air on the contact area by pointing the tube/nozzle about ½ inch away from the surface. CAUTION: Do not point nozzle at yourself and others, ensure the nozzle or tube is away from your face.

8. Inspect the area for any grease or dirt, repeat if required.
9. Replace the battery in the MC9500-K.

Cleaning Cradle Connectors

To clean the connectors on a cradle:

1. Remove the DC power cable from the cradle.
2. Dip the cotton portion of the cotton tipped applicator in isopropyl alcohol.
3. Rub the cotton portion of the cotton tipped applicator along the pins of the connector(s). Slowly move the applicator back-and-forth from one side of the connector to the other. Do not let any cotton residue on the connector.
4. All sides of the connector should also be rubbed with the cotton tipped applicator.
5. Spray compressed air in the connector area by pointing the tube/nozzle about ½ inch away from the surface. CAUTION: do not point nozzle at yourself and others, ensure the nozzle or tube is pointed away from your face.
6. Ensure that there is no lint left by the cotton tipped applicator, remove lint if found.
7. If grease and other dirt can be found on other areas of the cradle, use lint free cloth and alcohol to remove.
8. Allow at least 10 to 30 minutes (depending on ambient temperature and humidity) for the alcohol to air dry before applying power to cradle.

If the temperature is low and humidity is high, longer drying time is required. Warm temperature and dry humidity requires less drying time.

Cleaning Frequency

The cleaning frequency is up to the customer's discretion due to the varied environments in which the mobile devices are used. They may be cleaned as frequently as required. However when used in dirty environments it may be advisable to periodically clean the scanner exit window to ensure optimum scanning performance.

Troubleshooting

MC9500-K

Table 9-1 Troubleshooting the MC9500-K

Problem	Cause	Solution
MC9500-K does not turn on.	Battery not charged.	Charge or replace the battery in the MC9500-K.
	Battery not installed properly.	Install the battery properly. See Installing the Battery on page 1-6 .
	System crash.	Perform a warm boot. If the MC9500-K still does not turn on, perform a cold boot. See Resetting the MC9500-K on page 3-3 .
Battery did not charge.	Battery failed.	Replace battery. If the MC9500-K still does not operate, perform a warm boot, then a cold boot. See Resetting the MC9500-K on page 3-3 .
	No power to cradle or cable.	Ensure that power is applied to the cradle or cable. The Battery Status LED flashes amber to indicate that the MC9500-K is charging.
	MC9500-K removed from cradle while battery was charging.	Hook the MC9500-K onto the cradle. The 4800 mAh battery fully charges in less than six hours.
	Extreme battery temperature.	Battery does not charge if ambient temperature is below 0°C (32°F) or above 40°C (104°F).
	MC9500-K not functioning.	Perform a warm boot. If the MC9500-K still does not turn on, perform a cold boot. See Resetting the MC9500-K on page 3-3 .
Cannot see characters on display.	MC9500-K not powered on.	Press the Power button.
During data communication, no data transmitted, or transmitted data was incomplete.	MC9500-K removed from cradle or disconnected from host computer during communication.	Replace the MC9500-K onto the cradle, or reattach the communication cable and re-transmit.
	Incorrect cable configuration.	See the system administrator.
	Communication software was incorrectly installed or configured.	Perform setup. Refer to the <i>MC9500-K Mobile Computer Integrator Guide</i> for details.
No sound.	Volume setting is low or turned off.	Adjust the volume. See Adjusting Volume on page 3-20 .

Table 9-1 Troubleshooting the MC9500-K (Continued)

Problem	Cause	Solution
MC9500-K shuts off.	MC9500-K is inactive.	The MC9500-K turns off after a period of inactivity. If the MC9500-K is running on battery power, set this period from 1 to 5 minutes, in one-minute intervals. If the MC9500-K is running on external power, set this period to 1, 2, 5, 10, 15, or 30 minutes. Check the Power window by selecting Start > Settings > System tab and tapping the Power icon. Select the Advanced tab and change the setting for a longer delay before the automatic shutoff feature activates.
	Battery is depleted.	Replace the battery.
	Battery is not inserted properly.	Insert the battery properly. See Installing the Battery on page 1-6 .
Tapping the window buttons or icons does not activate the corresponding feature.	Screen is not calibrated correctly.	Re-calibrate the screen. Tap Start > Settings > System tab > Screen icon > Align Screen button.
	The MC9500-K is not responding.	Warm boot the MC9500-K. See Resetting the MC9500-K on page 3-3 .
A message appears stating that the MC9500-K memory is full.	Too many files stored on the MC9500-K.	Delete unused memos and records. If necessary, save these records on the host computer (or use a microSD card for additional memory).
	Too many applications installed on the MC9500-K.	Remove user-installed applications on the MC9500-K to recover memory. Select Start > Settings > System tab and tap the Remove Programs icon. Select the unused program and tap Remove .
The Battery Status LED flashes with the Power button is pressed and the MC9500-K does not turn on.	The MC9500-K's battery is low.	Recharge the battery.
Camera application does not launch.	DataWedge application running.	Stop DataWedge application. Tap Start > Settings > System > Task Manager . Select DataWedge application and tap End Task .

Table 9-1 *Troubleshooting the MC9500-K (Continued)*

Problem	Cause	Solution
The MC9500-K does not decode with reading bar code.	Scanning application is not loaded.	Load a scanning application on the MC9500-K. See your system administrator.
	Unreadable bar code.	Ensure the symbol is not defaced.
	Distance between exit window and bar code is incorrect.	Place the MC9500-K within proper scanning range.
	MC9500-K is not programmed for the bar code.	Program the MC9500-K to accept the type of bar code being scanned. Refer to the EMDK or Control Panel application.
	MC9500-K is not programmed to generate a beep.	If the MC9500-K does not beep on a good decode, set the application to generate a beep on good decode.
	Battery is low.	If the scanner stops emitting a laser beam upon a trigger press, check the battery level. When the battery is low, the scanner shuts off before the MC9500-K low battery condition notification. Note: If the scanner is still not reading symbols, contact the distributor or Motorola.

Bluetooth Connection

Table 9-2 *Troubleshooting Bluetooth Connection*

Problem	Cause	Solution
MC9500-K cannot find any Bluetooth devices nearby.	Too far from other Bluetooth devices.	Move closer to the other Bluetooth device(s), within a range of 10 meters.
	The Bluetooth device(s) nearby are not turned on.	Turn on the Bluetooth device(s) to find.
	The Bluetooth device(s) are not in discoverable mode.	Set the Bluetooth device(s) to discoverable mode. If needed, refer to the device's user documentation for help.
When trying to connect a Bluetooth phone and MC9500-K, the phone thinks a previously paired MC9500-K is used.	The phone remembers the name and address of the MC9500-K it last paired with via the Bluetooth radio.	Manually delete the pairing device and name from the phone. Refer to the phone's user documentation for instructions.

Single Bay USB Cradle

Table 9-3 Troubleshooting the Single Bay USB Cradle

Symptom	Possible Cause	Action
MC9500-K battery is not charging.	MC9500-K was removed from cradle or cradle was unplugged from AC power too soon.	Ensure cradle is receiving power. Ensure MC9500-K is seated correctly. Confirm main battery is charging under Start > Settings > System > Power . The 4800 mAh battery fully charges in less than six hours.
	Battery is faulty.	Verify that other batteries charge properly. If so, replace the faulty battery.
	No power to cradle.	Ensure that power is applied to the cradle. The Battery Status LED flashes amber to indicate that the MC9500-K is charging.
	The MC9500-K is not fully seated in the cradle.	Remove and re-insert the MC9500-K onto the cradle properly.
	Extreme battery temperature.	Battery does not charge if ambient temperature is below 0°C (32°F) or above 40°C (104°F).
	Single Bay USB Cradle is not functioning properly.	Replace the Single Bay USB Cradle.
During data communication, no data transmits, or transmitted data was incomplete.	MC9500-K removed from cradle during communications.	Replace MC9500-K in cradle and retransmit.
	Communication software is not installed or configured properly.	Perform setup as described in the <i>MC9500-K Mobile Computer Integrator Guide</i> .

Single Slot Battery Charger

Table 9-4 *Single Slot Battery Charger*

Symptom	Possible Cause	Action
Spare battery is not charging.	Battery not fully seated in charging slot.	Remove and re-insert the spare battery in the cradle, ensuring it is properly seated.
	Battery inserted incorrectly.	Re-insert the battery so the charging contacts on the battery align with the contacts on the cradle.
	Battery is faulty.	Verify that other batteries charge properly. If so, replace the faulty battery.
	No power to charger.	Ensure that power is applied to the charger. The Battery Status LED flashes amber to indicate that the battery is charging.
	Single Slot Battery Charger is not functioning properly.	Replace the Single Slot Battery Charger.

Four Bay Ethernet Cradle

Table 9-5 *Troubleshooting the Four Bay Ethernet Cradle*

Symptom	Cause	Solution
During communication, no data transmits, or transmitted data was incomplete.	MC9500-K removed from cradle during communications.	Replace MC9500-K in cradle and retransmit.
	MC9500-K has no active connection.	The Link LED flashes yellow if there is an active connection. See Four Bay Ethernet Cradle on page 8-9 .

Table 9-5 *Troubleshooting the Four Bay Ethernet Cradle (Continued)*

Symptom	Cause	Solution
Battery is not charging.	MC9500-K removed from the cradle too soon.	Replace the MC9500-K in the cradle. The 4800 mAh battery fully charges in less than six hours. Tap Start > Settings > System > Power to view battery status.
	Battery is faulty.	Verify that other batteries charge properly. If so, replace the faulty battery.
	No power to cradle.	Ensure that power is applied to the cradle. The Battery Status LED flashes amber to indicate that the MC9500-K is charging.
	MC9500-K is not inserted correctly in the cradle.	Remove the MC9500-K and reinsert it correctly. Verify charging is active. Tap Start > Settings > System > Power to view battery status.
	Ambient temperature of the cradle is too warm.	Move the cradle to an area where the ambient temperature is between 0°C (32°F) and 35°C (95°F).
	Single Four Bay Ethernet Cradle is not functioning properly.	Replace the Four Bay Ethernet Cradle.

Four Bay Charge Only Cradle

Table 9-6 *Troubleshooting the Four Bay Ethernet Cradle*

Symptom	Cause	Solution
Battery is not charging.	MC9500-K removed from the cradle too soon.	Replace the MC9500-K in the cradle. The 4800 mAh battery fully charges in less than six hours. Tap Start > Settings > System > Power to view battery status.
	Battery is faulty.	Verify that other batteries charge properly. If so, replace the faulty battery.
	No power to cradle.	Ensure that power is applied to the cradle. The Battery Status LED flashes amber to indicate that the MC9500-K is charging.
	MC9500-K is not inserted correctly in the cradle.	Remove the MC9500-K and reinsert it correctly. Verify charging is active. Tap Start > Settings > System > Power to view battery status.
	Ambient temperature of the cradle is too warm.	Move the cradle to an area where the ambient temperature is between 0°C (32°F) and 35°C (95°F).
	Four Bay Charge Only Cradle is not functioning properly.	Replace the Four Bay Charge Only Cradle.

Vehicle Cradle

Table 9-7 *Troubleshooting the Vehicle Cradle*

Symptom	Possible Cause	Action
MC9500-K battery charging LED does not light up.	Cradle is not receiving power.	Ensure the power input cable is securely connected to the cradle's power port.
MC9500-K battery is not recharging.	MC9500-K was removed from the cradle too soon.	Replace the MC9500-K in the cradle. The 4800 mAh battery fully charges in less than six hours.
	Battery is faulty.	Replace the battery.
	No power to charger.	Ensure that power is applied to the charger. The Battery Status LED flashes amber to indicate that the battery is charging.
	MC9500-K is not placed correctly in the cradle.	Remove the MC9500-K from the cradle, and re-insert correctly. If the battery still does not charge, contact customer support. The MC9500-K battery charging LED slowly blinks amber when the MC9500-K is correctly inserted and charging.
	Ambient temperature of the cradle is too warm.	Move to an area where the ambient temperature is between 0°C and 35°C.
	Vehicle Cradle is not functioning properly.	Replace the Vehicle Cradle.

Four Slot Battery Charger

Table 9-8 *Troubleshooting The Four Slot Battery Charger*

Symptom	Possible Cause	Action
Battery not charging.	Battery was removed from the charger or charger was unplugged from AC power too soon.	Re-insert the battery in the charger or re-connect the charger's power supply. The 4800 mAh battery fully charges in less than six hours.
	Battery is faulty.	Verify that other batteries charge properly. If so, replace the faulty battery.
	No power to charger.	Ensure that power is applied to the charger. The Battery Status LED flashes amber to indicate that the battery is charging.
	Battery contacts not connected to charger.	Verify that the battery is seated in the battery well correctly with the contacts facing down.
	Four Slot Battery Charger is not functioning properly.	Replace the Four Slot Battery Charger.

Cables

Table 9-9 *Troubleshooting the Cables*

Symptom	Possible Cause	Action
MC9500-K battery is not charging.	MC9500-K was disconnected from AC power too soon.	Connect the power cable correctly. Confirm main battery is charging under Start > Settings > System > Power . The 4800 mAh battery fully charges in less than six hours.
	Battery is faulty.	Verify that other batteries charge properly. If so, replace the faulty battery.
	No power to cable.	Ensure that power is applied to the cable. The Battery Status LED flashes amber to indicate that the battery is charging.
	The MC9500-K is not fully attached to power.	Detach and re-attach the power cable to the MC9500-K, ensuring it is firmly connected.
	Cable is not functioning properly.	Replace the cable.

Table 9-9 *Troubleshooting the Cables (Continued)*

Symptom	Possible Cause	Action
During data communication, no data transmits, or transmitted data was incomplete.	Cable was disconnected from MC9500-K during communications.	Re-attach the cable and retransmit.
	Incorrect cable configuration.	See the system administrator.
	Communication software is not installed or configured properly.	Perform setup as described in the <i>MC9500-K Mobile Computer Integrator Guide</i> .

Magnetic Stripe Reader

Table 9-10 *Troubleshooting the Magnetic Stripe Reader*

Symptom	Possible Cause	Action
MSR cannot read card.	MSR removed from MC9500-K during card swipe.	Reattach MSR to MC9500-K and reswipe the card.
	Faulty magnetic stripe on card.	See the system administrator.
	MSR application is not installed or configured properly.	Ensure the MSR application is installed on the MC9500-K. Ensure the MSR application is configured correctly.
MC9500-K battery is not charging.	MC9500-K was removed from MSR or MSR was unplugged from AC power too soon.	Ensure MSR is attached correctly.
	Battery is faulty.	Verify that other batteries charge properly. If so, replace the faulty battery.
	The MC9500-K is not fully attached to the MSR.	Detach and re-attach the MSR to the MC9500-K, ensuring it is firmly connected.
	MSR is faulty.	Replace MSR.
During data communication, no data transmits, or transmitted data was incomplete.	MC9500-K detached from MSR during communications.	Reattach MC9500-K to MSR and retransmit.
	Communication software is not installed or configured properly.	Perform setup as described in the <i>MC9500-K Mobile Computer Integrator Guide</i> .

Appendix A Technical Specifications

MC9500-K Technical Specifications

The following tables summarize the mobile computer's intended operating environment and technical hardware specifications.

MC9500-K

Table A-1 MC9500-K Technical Specifications

Item	Description
Physical Characteristics	
Dimensions	Height: 23.36 cm (9.2 in.) Depth: 5.08 cm (2.0 in.) Width: 8.89 cm (3.5 in.)
Weight	623.7 g (22 oz.)
Display	Transflective color 3.7" VGA with backlight, TFT-LCD, 65K colors, 480 pixels W x 640 pixels L
Touch Panel	Polycarbonate analog resistive touch
Backlight	LED backlight
Battery	Rechargeable Lithium Ion 3.7V, 4800 mAh Smart battery
Expansion Slot	User accessible microSD slot. Supports up to 16 GB cards.
Network Connections	High-speed USB client, full-speed USB host
Notification	Programmable LED, audio notifications and vibrator alerts.
Keypad Options	Alpha Primary Alpha Numeric Calculator Numeric Telephony Numeric

Table A-1 MC9500-K Technical Specifications (Continued)

Item	Description
Audio	VoWWAN; VoWLAN; TEAM Express compliant, rugged audio connector; high-quality speakerphone; headset (wired or Bluetooth) and handset and speaker phone modes.
Performance Characteristics	
CPU	Marvell PXA320 processor at 806 MHz
Operating System	MC9590: Microsoft® Windows Mobile™ 6.1 Classic MC9596 and MC9598: Microsoft® Windows Mobile™ 6.1 Professional
Memory	128 MB RAM/512MB Flash
Interface	USB 2.0 Client/USB 1.1 Host
Output Power	USB: 5 VDC @ 500 mA max.
User Environment	
Operating Temperature	-20°C to 50°C (-4°F to 122°F)
Storage Temperature	-40°C to 70°C (-40°F to 158°F)
Charging Temperature	32°F to 104°F / 0° C to 40° C
Humidity	5 - 95% non-condensing
Drop Specification	1.8 m (6 ft.) drop to concrete across the operating temperature range; meets and exceeds applicable MIL-STD-810G drop specifications.
Tumble	2000 1 m (3.2 ft.) tumbles (4,000 hits) at room temperature; meets and exceeds applicable IEC tumble specifications.
Electrostatic Discharge (ESD)	+/-15kVdc air discharge, +/-8kVdc direct discharge, +/-8kVdc indirect discharge
Sealing	IP67 sealing; meets and exceeds applicable IEC sealing specifications.
Wireless WAN Data and Voice Communications	
Wireless Wide Area Network (WWAN) radios	MC9596: GSM: GPRS/HSDPA (850, 900, 1800, 1900 and 2100 MHz) MC9598: CDMA: EvDO Rev. A (850 and 1900MHz)
Wireless LAN Data and Voice Communications	
Wireless Local Area Network (WLAN) radio	Tri-mode IEEE® 802.11a/b/g
Data Rates Supported	1, 2, 5.5, 6, 9, 11, 12, 18, 24, 36, 48, and 54 Mbps
Operating Channels	Chan 1-13 (2412-2472 MHz), Chan 14 (2484 MHz) Japan only; actual operating channels/frequencies depend on regulatory rules and certification agency

Table A-1 MC9500-K Technical Specifications (Continued)

Item	Description
WLAN Security	TKIP, AES, WPA (Personal or Enterprise), WPA2 (Personal or Enterprise), 802.1x, EAP-TLS, TTLS (CHAP, MS-CHAP, MS-CHAPv2, PAP or MD5), PEAP (TLS, MSCHAPv2, EAP-GTC), LEAP, EAP-FAST (TLS, MS-CHAPv2, EAP-GTC), CCXv4 certified, support for IPv6, FIPS140-2 certified
Spreading Technique	Direct Sequence Spread Spectrum (DSSS) and Orthogonal Frequency Division Multiplexing (OFDM)
Antenna	Internal with diversity
Voice Communication	Voice-over-IP ready (with P2P, PBX, PTT clients), Wi-Fi™-certified, IEEE 802.11 a/b/g direct sequence wireless LAN, Wi-Fi Multimedia (WMM), Motorola Voice Quality manager (VQM)
Wireless PAN Data and Voice Communications	
Bluetooth	Class II, v 2.1 with EDR; internal antenna.
IrDA	Infra-red port for connection to printers and other devices.
Regulatory	
Electrical Safety	IEC/UL/CSA/EN 60950-1
Environmental	RoHS-compliant
WLAN and Bluetooth (PAN)	USA: FCC Part 15.247, 15.407 Canada: RSS-210 EU: EN 300 328, EN 301 893 Japan: ARIB STD-T33, T66, T70, T71 Australia: AS/NZS 4268s
Wireless Wide Area Network	GSM-HSDPA Global: 3GPP TS 51.010, 3GPP TS 34.121, 3GPP TS 34.123, GCF approved module USA: FCC Part 22, Part 24 Canada: RSS-132, RSS-133 EU: EN 301 511, EN 301 908 Australia: AS/ACIF S 024 CDMA-EvDO Rev A USA: FCC Part 22, Part 24 Canada: RSS-129, RSS-133 HAC compliant
RF Exposure	USA: FCC Part 2, FCC OET Bulletin 65 Supplement C Canada: RSS-102 EU: EN 50360 Japan: ARIB STD T56 Australia: Radio communications Standard 2003

Table A-1 MC9500-K Technical Specifications (Continued)

Item	Description
EMI/RFI	USA: FCC Part 15, Class B Canada: ICES 003 Class B EU: EN55022 Class B, EN55024, EN 301 489-1, EN 301 489-7, EN 301 489-17, EN 301 489-19, EN 301 489-24, EN 60601-1-2, EN 50121-3-2, EN 50121-4 Australia: AS/NZS CISPR-22
Laser Safety	IEC/Class 2/FDA Class II in accordance with IEC60825-1/EN60825-1
Data Capture Specifications	
Options	1D laser scanner 2D imager 1D laser scanner and color camera 2D imager and color camera
Linear 1D Scanner (SE950) Specifications	
Optical Resolution	4mil minimum element width
Roll	+/- 35° from vertical
Pitch Angle	+/- 65° from normal
Skew Tolerance	+/- 50° from normal
Ambient Light	10,000 ft. candles (107,640 Lux)
Shock	2,000 +/- 5% G
Scan Rate	104 (+/- 12) scans/sec (bidirectional)
Scan Angle	47° +/- 5° (typical); 35° +/- 3° reduced
2D Imager Engine (SE4500) Specifications	
Field of View	Horizontal - 40° Vertical - 25°
Optical Resolution	752 H x 480 V pixels (gray scale)
Roll	360°
Pitch Angle	+/- 60° from normal
Skew Tolerance	+/- 60° from normal
Ambient Light	9,000 ft. candles (96,900 Lux)
Shock	2,000 +/- 5% G
Focal Distance from Front of Engine	Near: 5 inches Far: 9 inches
Aiming Element (VLD)	655 nm +/- 10 nm

Table A-1 *MC9500-K Technical Specifications (Continued)*

Item	Description
Illumination Element (LED)	625 nm +/- 5 nm LEDs (2x)
Camera Specifications	
Resolution	2 Mega pixel with flash and auto focus.

Table A-2 *Data Capture Options*

Item	Description		
Laser Decode Capability	Code 39 Codabar Interleaved 2 of 5 MSI UPC/EAN supplementals Webcode GS1 DataBar Truncated GS1 DataBar Expanded GS1 DataBar Stacked Omni	Code 128 Code 11 EAN-8 UPCA Coupon Code Chinese 2 of 5 GS1 DataBar Limited GS1 DataBar Expanded Stacked	Code 93 Discrete 2 of 5 EAN-13 UPCE Trioptic 39 GS1 DataBar GS1 DataBar Stacked
Imaging Decode Capability	Code 39 Codabar Discrete 2 of 5 EAN-13 UPC/EAN supplementals Webcode Composite C Macro PDF-417 Data Matrix US Planet Canadian 4-state Chinese 2 of 5 microQR GS1 DataBar Truncated GS1 DataBar Expanded GS1 DataBar Stacked Omni	Code 128 Code 11 MSI UPCA Coupon Code TLC39 Micro PDF-417 (Macro) Micro PDF-417 Maxi Code UK 4-state Japanese 4-state USPS 4-state (US4CB) GS1 DataBar GS1 DataBar Limited GS1 DataBar Expanded Stacked	Code 93 Interleaved 2 of 5 EAN-8 UPCE Trioptic 39 Composite AB PDF-417 QR Code US Postnet Australian 4-state Dutch Kix Aztec GS1 DataBar Stacked
Camera Decode Capability	Code 39 Codabar Discrete 2 of 5 EAN-13 UPC/EAN supplementals Webcode Composite C Macro PDF-417 Data Matrix US Planet Canadian 4-state GS1 DataBar GS1 DataBar Truncated GS1 DataBar Expanded GS1 DataBar Stacked Omni	Code 128 Code 11 MSI UPCA Coupon Code TLC39 Micro PDF-417 (Macro) Micro PDF-417 Maxi Code UK 4-state Japanese 4-state	Code 93 Interleaved 2 of 5 EAN-8 UPCE Trioptic 39 Composite AB PDF-417 QR Code US Postnet Australian 4-state Dutch Kix GS1 DataBar Limited GS1 DataBar Expanded Stacked GS1 DataBar Stacked

MC9500-K Accessory Specifications

Single Bay USB Cradle

Table A-3 *Single Bay USB Cradle Technical Specifications*

Feature	Description
Dimensions	Height: 15.45 cm (6.08 in.) Width: 12.00 cm (4.72 in.) Depth: 18.90 cm (7.44 in.)
Weight	430 g (15.2 oz)
Input Power	12 VDC
Power Consumption	22 watts
Interface	USB
Operating Temperature	0°C to 50°C (32°F to 122°F)
Storage Temperature	-40°C to 70°C (-40°F to 158°F)
Charging Temperature	0°C to 40°C (32°F to 104°F)
Humidity	5% to 95% non-condensing
Drop	76.2 cm (30.0 in.) drops to vinyl tiled concrete at room temperature
Electrostatic Discharge (ESD)	+/- 15 kV air +/- 8 kV contact

Single Slot Battery Charger

Table A-4 *Single Slot Battery Charger Technical Specifications*

Feature	Description
Dimensions	Height: 11.15 cm (4.39 in.) Width: 7.70 cm (3.03 in.) Depth: 9.95 cm (3.92 in.)
Weight	105 g (3.7 oz)
Input Power	12 VDC
Power Consumption	4.7 watts
Interface	USB
Operating Temperature	0°C to 40°C (32°F to 122°F)
Storage Temperature	-40°C to 70°C (-40°F to 158°F)

Table A-4 Single Slot Battery Charger Technical Specifications (Continued)

Feature	Description
Charging Temperature	0°C to 40°C (32°F to 104°F)
Humidity	5% to 95% non-condensing
Drop	76.2 cm (30.0 in.) drops to vinyl tiled concrete at room temperature
Electrostatic Discharge (ESD)	+/- 15 kV air +/- 8 kV contact

Four Bay Ethernet Cradle

Table A-5 Four Bay Ethernet Cradle Technical Specifications

Feature	Description
Dimensions	Height: 11.3 cm (4.45 in.) Width: 45.7 cm (18.00 in.) Depth: 5.6 cm (2.20 in.)
Weight	735 g (1.47 lb)
Input Power	12 VDC
Power Consumption	88 watts
Interface	Ethernet
Operating Temperature	0°C to 50°C (32°F to 122°F)
Storage Temperature	-40°C to 70°C (-40°F to 158°F)
Charging Temperature	0°C to 40°C (32°F to 104°F)
Humidity	5% to 95% non-condensing
Drop	76.2 cm (30.0 in.) drops to vinyl tiled concrete at room temperature
Electrostatic Discharge (ESD)	+/- 15 kV air +/- 8 kV contact

Four Bay Charge Only Cradle

Table A-6 *Four Bay Charge Only Cradle Technical Specifications*

Feature	Description
Dimensions	Height: 11.3 cm (4.45 in.) Width: 45.7 cm (18.00 in.) Depth: 5.6 cm (2.20 in.)
Weight	705 g (1.41 lb)
Input Power	12 VDC
Power Consumption	88 watts
Operating Temperature	0°C to 50°C (32°F to 122°F)
Storage Temperature	-40°C to 70°C (-40°F to 158°F)
Charging Temperature	0°C to 40°C (32°F to 104°F)
Humidity	5% to 95% non-condensing
Drop	76.2 cm (30.0 in.) drops to vinyl tiled concrete at room temperature
Electrostatic Discharge (ESD)	+/- 15 kV air +/- 8 kV contact

Four Slot Battery Charger

Table A-7 *Four Slot Battery Charger Technical Specifications*

Feature	Description
Dimensions	Height: 3.47 cm (1.37 in.) Width: 15.50 cm (6.10 in.) Depth: 21.00 cm (8.27 in.)
Weight	386 g (13.6 oz)
Input Power	12 VDC
Power Consumption	19 watts
Operating Temperature	0°C to 40°C (32°F to 122°F)
Storage Temperature	-40°C to 70°C (-40°F to 158°F)
Charging Temperature	0°C to 40°C (32°F to 104°F)

Table A-7 Four Slot Battery Charger Technical Specifications (Continued)

Feature	Description
Humidity	5% to 95% non-condensing
Drop	76.2 cm (30.0 in.) drops to vinyl tiled concrete at room temperature
Electrostatic Discharge (ESD)	+/- 15 kV air +/- 8 kV contact

Magnetic Stripe Reader

Table A-8 Magnetic Stripe Reader (MSR) Technical Specifications

Feature	Description
Dimensions	Height: 3.56 cm (1.4 in.) Width: 8.38 cm (3.3 in.) Depth: 7.87 cm (3.1 in.)
Weight	48 g (1.7 oz)
Interface	Serial with baud rate up to 19,200
Format	ANSI, ISO, AAMVA, CA DMV, user-configurable generic format
Swipe Speed	5 to 50 in. (127 to 1270 mm) /sec, bi-directional
Decoders	Generic, Raw Data
Mode	Buffered, unbuffered
Track Reading Capabilities	Tracks 1 and 3: 210 bpi Track 2: 75 and 210 bpi, autodetect
Operating Temperature	0°C to 50°C (32°F to 122°F)
Storage Temperature	-40°C to 70°C (-40°F to 158°F)
Humidity	5% to 95% non-condensing
Drop	1.22 m (4 ft.) drops to concrete
Electrostatic Discharge (ESD)	+/- 15 kV air +/- 8 kV contact

Vehicle Cradle

Table A-9 *Vehicle Cradle Technical Specifications*

Feature	Description
Dimensions	Height: 22.25 cm (8.76 in.) Width: 15.40 cm (6.06 in.) Depth: 9.75 cm (3.84 in.)
Weight	805 g (28.4 oz)
Input Power	12/24 VDC
Power Consumption	22 watts
Operating Temperature	0°C to 50°C (32°F to 122°F)
Storage Temperature	-40°C to 70°C (-40°F to 158°F)
Charging Temperature	0°C to 40°C (32°F to 104°F)
Humidity	10% to 95% non-condensing
Drop	76.2 cm (30.0 in.) drops to vinyl tiled concrete at room temperature
Electrostatic Discharge (ESD)	+/- 15 kV air +/- 8 kV contact

Vehicle Battery Charger

Table A-10 *Vehicle Battery Charger Technical Specifications*

Feature	Description
Dimensions	Height: 14.70 cm (5.79 in.) Width: 6.75 cm (2.66 in.) Depth: 4.75 cm (1.87 in.)
Weight	130 g (4.6 oz)
Input Power	5.4 VDC
Power Consumption	4.7 watts
Operating Temperature	0°C to 40°C (32°F to 122°F)
Storage Temperature	-40°C to 70°C (-40°F to 158°F)
Charging Temperature	0°C to 40°C (32°F to 104°F)

Table A-10 *Vehicle Battery Charger Technical Specifications (Continued)*

Feature	Description
Humidity	10% to 95% non-condensing
Drop	76.2 cm (30.0 in.) drops to vinyl tiled concrete at room temperature
Electrostatic Discharge (ESD)	+/- 15 kV air +/- 8 kV contact

Appendix B Voice Quality Manager

Introduction

The Voice Quality Manager (VQM) is a software package that resides on the MC95XX. VQM enables a set of features for Voice over WiFi (VoWiFi) calls, and a sub-set of those features for cellular line calls. The VQM user interface is designed to be intuitive and easy to use, so complex tasks such as enabling the Acoustic Echo Canceller (AEC) while a call is in progress are done with very little or no user intervention.

Features

The VQM software:

- Improves the voice transmission quality without using additional battery power.
- Turns on the AEC for VoWiFi calls automatically, without user intervention.
- Prioritizes the outgoing audio IP packets.
- Provides user-selectable audio modes (speakerphone and handset) with a single tap of the VQM icon. A VQM icon in the title bar of the device indicates the audio mode currently in use.
- NDIS 5.1 compliant.

Enabling VQM

To enable VQM:

1. Tap **Start > Programs > File Explorer**.
2. Navigate to the **Windows** folder.
3. Locate the file **VQMAudioNotify**.
4. Tap the filename to enable VQM.

Audio Modes

The MC95XX can be in any one of the seven different audio modes. The mode is visually indicated by the VQM icon on the title bar.

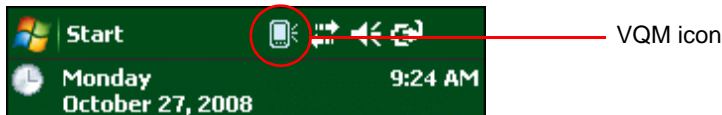









Figure B-1 VQM Icon in Title Bar

The VQM icon indicates that the device is in speakerphone mode without Acoustic Echo Cancellation (indicated by the gray VQM icon). The audio modes and their corresponding VQM title bar icons are:

Table B-1 VQM Icons

Icon	Description
	Speakerphone with Acoustic Echo Cancellation.
	Speakerphone without Acoustic Echo Cancellation.
	Handset with Acoustic Echo Cancellation (device is in handset mode only while on a call).
	Headset while on a call (Acoustic Echo Cancellation is not enabled for Bluetooth headsets).
	Headset while not on a call.
	Bluetooth headset while on a call (Acoustic Echo Cancellation is not enabled for Bluetooth headsets). White icon.
	Bluetooth headset while not on a call. Gray icon.

Changing Audio Modes

Depending upon the audio mode being used, the mode can be changed by tapping the VQM icon in the title bar. The audio mode can only be changed only while the user is on a call.

The table below lists the current audio mode and the subsequent audio mode after tapping the VQM icon.

Table B-2 *Changing Audio Modes*

Audio Mode before Tapping VQM Icon	Audio Mode after Tapping VQM Icon
Speakerphone	Handset
Handset	Speakerphone
Bluetooth headset	Speakerphone

If the audio mode is set to speakerphone and the user taps the VQM icon, the audio mode changes to handset.

If the user is using a Bluetooth headset, tapping the VQM icon un-pairs the Bluetooth headset from the device causing the audio to be routed to the default mode. In VQM 2.5, there is no way to go back to the Bluetooth headset using the VQM icon if it is un-paired. The only way to reconnect the Bluetooth headset to the device is by using the BTExplorer application.

If the user taps the VQM icon when a wired headset is connected to the mobile device, the audio mode does not change. The audio continues to get routed to the wired headset.

If the user taps the VQM icon while not on a call there is not change to the audio mode.

Tap and hold the VQM icon in the title bar to display a notification dialog box that contains:

- AEC: The Acoustic Echo Canceller status
- DSCP Marked Packets: The number of outbound voice packets that have been recognized and marked as high priority by VQM.
- VQM Version: The VQM version number.



Figure B-2 *VQM Audio Control Dialog Box*

Voice Packet Prioritization

IP soft phones transmit voice packets in the same manner as any other application that sends data over the network. On a network with different types of traffic, voice packets are given the same priority as any other traffic, and therefore may be subject to delays.

WiFi Multi-media (WMM) is a solution to this problem. WMM is a specification that supports prioritizing traffic, and “higher-priority” packets can be given preferential treatment.

To make use of WMM, the devices that generate traffic must mark their packets as high or normal priority in a field in the IP packet called Differentiated Services Code-Point (DSCP). The wireless infrastructure, which must be configured to support WMM, gives a higher priority to packets that have been marked as high priority through DSCP marking by the devices that generate traffic.

VQM detects if there is an ongoing Voice over WiFi (VoWiFi) call, and if so, marks outgoing voice packets (Only outgoing voice packets can be marked. The incoming voice packets have already been through the network, so it makes no sense to mark them.) as high-priority using DSCP. This enables WMM-compatible wireless infrastructure to treat the voice packets preferentially. This results in fewer delays for voice packets, which in turn improves the call quality.

Limitations

- There is no VPN support in VQM.
- Only the Avaya softphone is currently supported.

Acoustic Echo Cancellation

Acoustic Echo occurs during a voice call when the audio from the earpiece enters the microphone of the same device. This results in the person at the other end hearing back a delayed version of his/her own voice (“Echo”). Needless to say, “Echo” is not desirable, and needs to be suppressed. This is the functionality performed by the Acoustic Echo Canceller (AEC). There are two approaches to suppressing the Echo:

- Turn the Acoustic Echo Canceller (AEC) on permanently. This approach is not very efficient because the device consumes more power when the AEC is on.
- Turn the Acoustic Echo Canceller (AEC) on only when there is an ongoing call.

VQM follows the second of the two approaches mentioned above.

VQM automatically turns on the Acoustic Echo Canceller (AEC) when the mobile device is in a VoWiFi call. When the call is terminated, VQM turns the AEC off. Note that the AEC is turned on for speakerphone and handset modes and does not get turned on for wired headset and Bluetooth headset modes. The AEC is not required for wired headset because the audio volume is quite low (because of the proximity of the earpiece to the ear), and therefore it is very unlikely for the audio from the earpiece to go in to the mouthpiece. Bluetooth headsets typically have an Echo Canceller built in. Turning the AEC on only while on a call saves battery power, compared to leaving the AEC turned on permanently.

The AEC is not turned on for Cellular calls because the WWAN phone application has a built-in echo canceller.

Disabling VQM

To disable VQM perform a warm boot.

Appendix C Keypads



Introduction

The MC9500-K offers four types modular keypad configurations:

- Alpha Primary
- Alpha Numeric
- Calculator Numeric
- Telephony Numeric.

Alpha Primary Keypad

The Alpha Primary keypad produces the 26-character alphabet (A-Z, both lowercase and uppercase), numbers (0-9), and assorted characters. The keypad is color-coded to indicate which modifier key to press to produce a particular character or action. The keypad default is lowercase alpha characters. See [Table C-1](#) for key and button descriptions and [Table C-9 on page C-18](#) for the keypad's special functions.

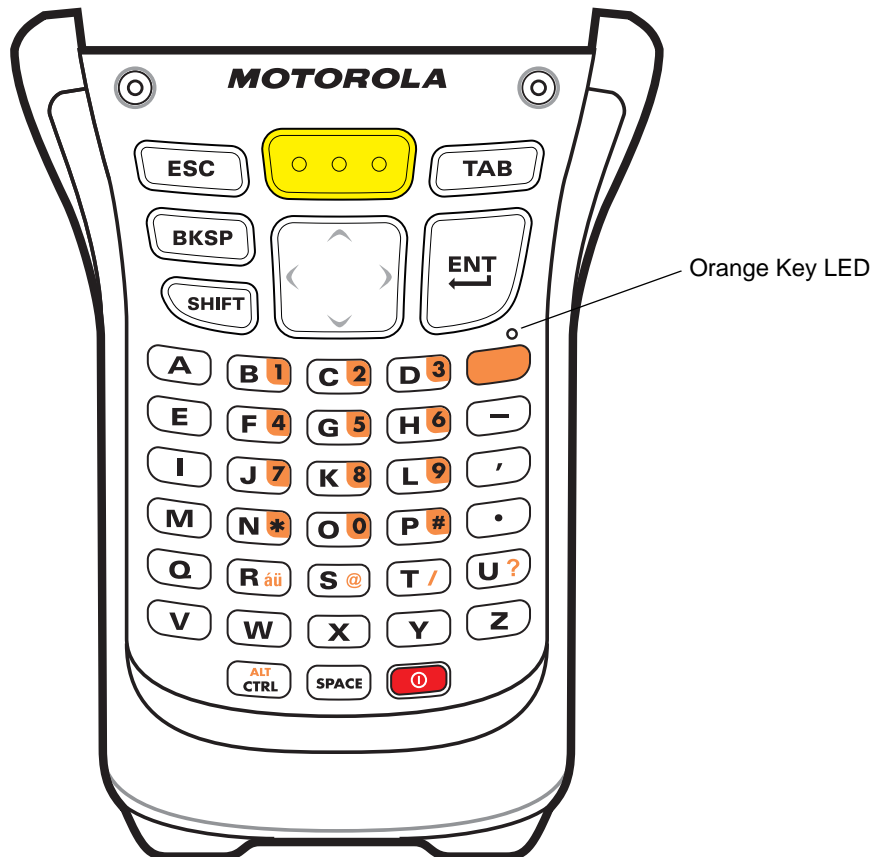

Figure C-1 Alpha Primary Keypad Configuration

Table C-1 Alpha Primary Keypad Descriptions









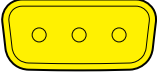
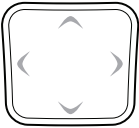

Key	Action
Orange Key 	<p>Accesses the secondary layer of characters and actions (shown on the keypad in orange).</p> <p>Press the Orange key once to activate this mode temporarily, followed by another key. This illuminates the LED and displays the following icon at the bottom of the screen, until a second key is pressed: </p> <p>Press the Orange key twice to lock this mode. This illuminates the LED and displays the following icon at the bottom of the screen: </p> <p>Press the Orange key a third time to unlock.</p>
Scan 	<p>Activates the scanner/imager in a scan enabled application.</p>
Navigation 	<p>Moves up one item.</p> <p>Moves left one item when pressed with the Orange key.</p> <p>Moves down one item.</p> <p>Moves right one item when pressed with the Orange key.</p>
Shift 	<p>Changes the state of the alpha characters from lowercase to uppercase.</p> <ul style="list-style-type: none"> Press the Shift key to activate this mode temporarily, followed by another key. This displays the following icon at the bottom of the screen, until a second key is pressed:  Press the Shift key twice to lock this mode. This displays the following icon at the bottom of the screen:  <p>Press the Shift key a third time to unlock.</p>
Backspace 	<p>Produces a backspace.</p>
Enter 	<p>Executes a selected item or function.</p>
CTRL 	<p>Press and release the CTRL key to activate the keypad alternate CTRL functions. The  icon appears at the bottom of the screen.</p> <p>Press the Orange key followed by the CTRL key to activate the keypad alternate ALT functions. The  icon appears at the bottom of the screen.</p>

Table C-1 Alpha Primary Keypad Descriptions (Continued)



Key	Action
SPACE 	Produces a space character.
ESC 	Exits the current operation.
TAB 	Move from one field to another.

Table C-2 Alpha Primary Keypad Input Modes

Key	Normal	Shift + Key	Orange + Key
A	a	A	a
B	b	B	1
C	c	C	2
D	d	D	3
E	e	E	e
F	f	F	4
G	g	G	5
H	h	H	6
I	i	I	i
J	j	J	7
K	k	K	8
L	l	L	9
M	m	M	m
N	n	N	*
O	o	O	0
P	p	P	#
Q	q	Q	q
R	r	R	au

Note: An application can change the key functions. The keypad may not function exactly as described.

Table C-2 Alpha Primary Keypad Input Modes (Continued)

Key	Normal	Shift + Key	Orange + Key
S	s	S	@
T	t	T	/
U	u	T	?
V	v	V	v
W	w	W	w
X	x	X	x
Y	y	Y	y
Z	z	Z	z
-	-	-	-
'	'	<	'
.	.	>	.
ENTER	Enter	Enter	Enter
TAB	Tab	Tab	Tab
SPACE	Space	Space	Space
BKSP	Backspace	Backspace	Backspace

Note: An application can change the key functions. The keypad may not function exactly as described.

Alpha Numeric Keypad

The Alpha Numeric keypad produces the 26-character alphabet (A-Z, both lowercase and uppercase), numbers (0-9), and assorted characters. The keypad is color-coded to indicate which modifier key to press to produce a particular character or action. The keypad default is lowercase alpha characters and numerics. See [Table C-3](#) for key and button descriptions and [Table C-9 on page C-18](#) for the keypad's special functions.

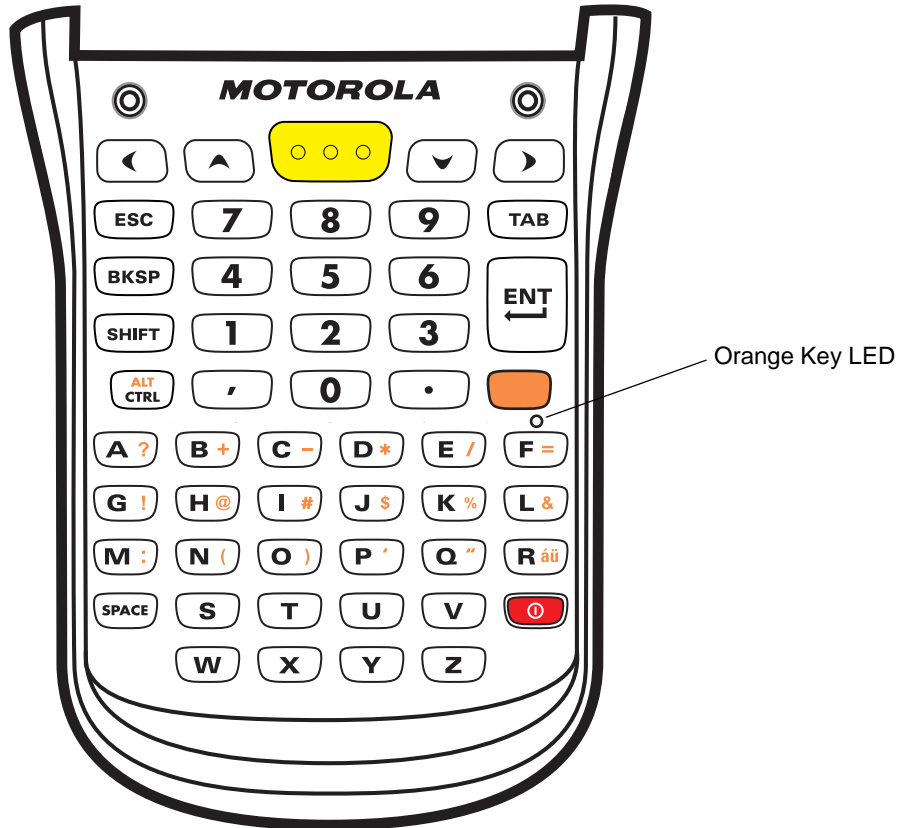

Figure C-2 Alpha Numeric Keypad Configuration

Table C-3 Alpha Numeric Keypad Descriptions









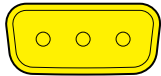
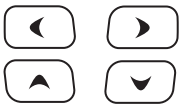

Key	Action
Orange Key 	Accesses the secondary layer of characters and actions (shown on the keypad in orange). Press the Orange key once to activate this mode temporarily, followed by another key. This illuminates the LED and displays the following icon at the bottom of the screen, until a second key is pressed:  Press the Orange key twice to lock this mode. This illuminates the LED and displays the following icon at the bottom of the screen:  Press the Orange key a third time to unlock.
Scan 	Activates the scanner/imager in a scan enabled application.
Navigation 	Moves up, down, left or right one item.
Shift 	Changes the state of the alpha characters from lowercase to uppercase. <ul style="list-style-type: none"> • Press the Shift key to activate this mode temporarily, followed by another key. This displays the following icon at the bottom of the screen, until a second key is pressed:  • Press the Shift key twice to lock this mode. This displays the following icon at the bottom of the screen:  Press the Shift key a third time to unlock.
Backspace 	Produces a backspace.
Enter 	Executes a selected item or function.
CTRL 	Press and release the CTRL key to activate the keypad alternate CTRL functions. The  icon appears at the bottom of the screen. Press the Orange key followed by the CTRL key to activate the keypad alternate ALT functions. The  icon appears at the bottom of the screen.

Table C-3 Alpha Numeric Keypad Descriptions (Continued)



Key	Action
SPACE 	Produces a space character.
ESC 	Exits the current operation.
TAB 	Move from one field to another.

Table C-4 Alpha Numeric Keypad Input Modes

Key	Normal	Shift + Key	Orange + Key
1	1	!	1
2	2	@	2
3	3	#	3
4	4	\$	4
5	5	%	5
6	6	^	6
7	7	&	7
8	8	*	8
9	9	(9
0	0)	0
,	,	<	,
.	.	>	.
A	a	A	?
B	b	B	+
C	c	C	-
D	d	D	*
E	e	E	/
F	f	F	=
G	g	G	!

Note: An application can change the key functions. The keypad may not function exactly as described.

Table C-4 Alpha Numeric Keypad Input Modes (Continued)

Key	Normal	Shift + Key	Orange + Key
H	h	H	@
I	i	I	#
J	j	J	\$
K	k	K	%
L	l	L	&
M	m	M	:
N	n	N	(
O	o	O)
P	p	P	'
Q	q	Q	"
R	r	R	au
S	s	S	s
T	t	T	t
U	u	U	u
V	v	V	v
W	w	W	w
X	x	X	x
Y	y	Y	y
Z	z	Z	z
ENTER	Enter	Enter	Enter
TAB	Tab	Tab	Tab
SPACE	Space	Space	Space
BKSP	Backspace	Backspace	Backspace

Note: An application can change the key functions. The keypad may not function exactly as described.

Calculator Numeric Keypad

The Calculator Numeric keypad produces the numbers (0-9), 26-character alphabet (A-Z, both lowercase and uppercase), and assorted characters. The keypad is color-coded to indicate which modifier key to press to produce a particular character or action. The keypad default is numeric. See [Table C-5](#) for key and button descriptions and [Table C-9 on page C-18](#) for the keypad's special functions.

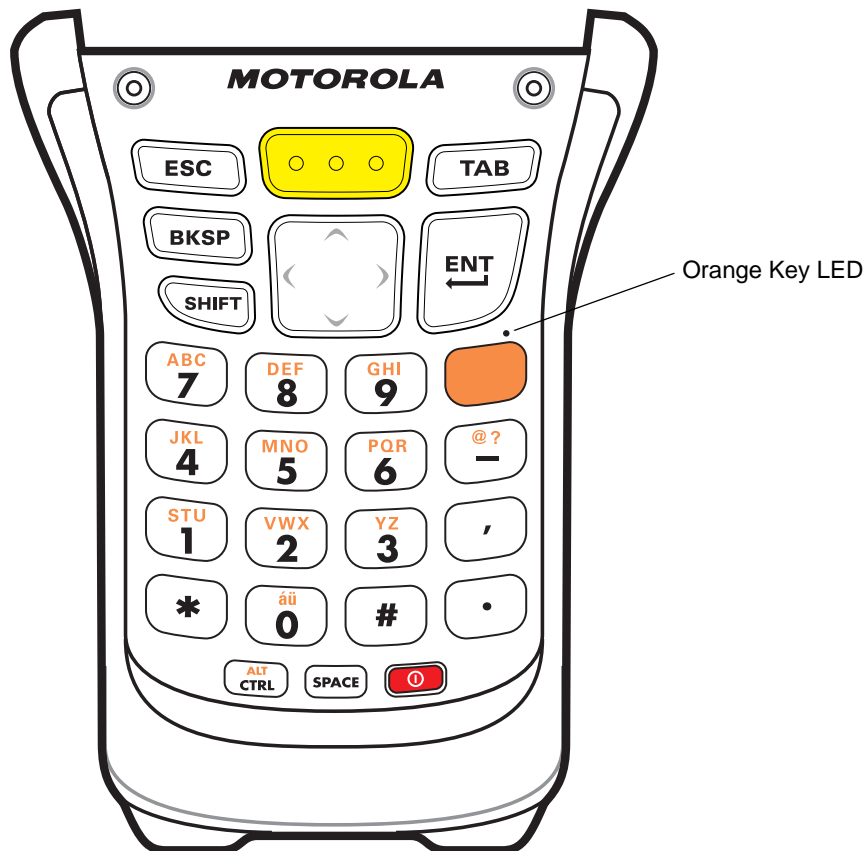

Figure C-3 Calculator Numeric Keypad Configuration

Table C-5 Calculator Numeric Keypad Descriptions









Key	Description
<p>Orange Key</p> 	<p>Use this key to access the secondary layer of characters and actions (shown on the keypad in orange). Press the Orange key once to lock the keypad into Alpha state. A single press illuminates the LED and displays the following icon at the bottom of the screen: </p> <p>Press the Orange key a second time to return to the normal state.</p> <p>Press the Orange key, then the Shift key to add a temporary shift (that applies only to the next key pressed) to the orange lock state. This displays the following icon at the bottom of the screen: </p>
<p>Scan</p> 	<p>Activates the scanner/imager in a scan enabled application.</p>
<p>Navigation</p> 	<p>Moves up, down, left or right one item.</p>
<p>Alphanumeric</p> 	<p>In default state, produces the numeric value on the key.</p> <p>In Alpha state, produces the lower case alphabetic characters on the key. Each key press produces the next alphabetic character in the sequence. For example, press and release the Orange key and then press the '4' key once to produce the letter 'j'; press and release the Orange key and then press the '4' key three times to produce the letter 'l'.</p> <p>Press the SHIFT key in Alpha state to produce the upper case alphabetic characters on the key. For example, press and release the Orange key, press and release the SHIFT key, and then press the '4' key once to produce the letter 'J'; press and release the Orange key, press and release the SHIFT key and then press the '4' key three times to produce the letter 'L'.</p>
<p>Backspace</p> 	<p>Produces a backspace.</p>
<p>SHIFT</p> 	<p>Press and release the SHIFT key to activate the keypad alternate SHIFT functions.</p> <p>A single press displays the following icon at the bottom of the screen, until a second key is pressed: </p> <p>Press the Orange key, then the Shift key to add a temporary shift (that applies only to the next key pressed) to the orange lock state. This displays the following icon at the bottom of the screen: </p>

Table C-5 Calculator Numeric Keypad Descriptions (Continued)

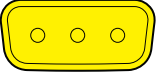
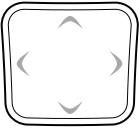





Key	Description
Enter 	Executes a selected item or function.
CTRL 	Press and release the CTRL key to activate the keypad alternate CTRL functions. The  icon appears at the bottom of the screen. Press the Orange key followed by the CTRL key to activate the keypad alternate ALT functions. The  icon appears at the bottom of the screen.
SPACE 	Produces a space character.
ESC 	Exits the current operation.
TAB 	Move from one field to another.

Table C-6 Calculator Numeric Keypad Input Modes

Key	Numeric Mode		Orange Key (Alpha Lowercase Mode)				Orange + Shift Keys (Alpha Uppercase Mode)			
		SHIFT + Key	1st Press	2nd Press	3rd Press	4th Press	1st Press	2nd Press	3rd Press	4th Press
1	1	!	s	t	u		S	T	U	
2	2	@	v	w	x		V	W	X	
3	3	#	y	z			Y	Z		
4	4	\$	j	k	l		J	K	L	
5	5	%	m	n	o		M	N	O	
6	6	^	p	q	r		P	Q	R	
7	7	&	a	b	c		A	B	C	
8	8	*	d	e	f		D	E	F	
9	9	(g	h	i		G	H	I	

Note: An application can change the key functions. The keypad may not function exactly as described.

Table C-6 *Calculator Numeric Keypad Input Modes (Continued)*

Key	Numeric Mode		Orange Key (Alpha Lowercase Mode)				Orange + Shift Keys (Alpha Uppercase Mode)			
		SHIFT + Key	1st Press	2nd Press	3rd Press	4th Press	1st Press	2nd Press	3rd Press	4th Press
0	0)	au				au			
-	-	_	@	?			@	?		
,	,	<	<				<			
.	.	>	.				>			
*	*	*	*				*			

Note: An application can change the key functions. The keypad may not function exactly as described.

Telephony Numeric Keypad

The Telephony Numeric keypad produces the numbers (0-9), 26-character alphabet (A-Z, both lowercase and uppercase), and assorted characters. The keypad is color-coded to indicate which modifier key to press to produce a particular character or action. The keypad default is numeric. See [Table C-7](#) for key and button descriptions and [Table C-9 on page C-18](#) for the keypad's special functions.



Figure C-4 Telephony Numeric Keypad Configuration

Table C-7 Telephony Numeric Keypad Descriptions









Key	Description
<p>Orange Key</p> 	<p>Use this key to access the secondary layer of characters and actions (shown on the keypad in orange). Press the Orange key once to lock the keypad into Alpha state. A single press illuminates the LED and displays the following icon at the bottom of the screen: </p> <p>Press the Orange key a second time to return to the normal state.</p> <p>Press the Orange key, then the Shift key to add a temporary shift (that applies only to the next key pressed) to the orange lock state. This displays the following icon at the bottom of the screen: </p>
<p>Scan</p> 	<p>Activates the scanner/imager in a scan enabled application.</p>
<p>Navigation</p> 	<p>Moves up, down, left or right one item.</p>
<p>Alphanumeric</p> 	<p>In default state, produces the numeric value on the key.</p> <p>In Alpha state, produces the lower case alphabetic characters on the key. Each key press produces the next alphabetic character in sequence. For example, press and release the Orange key and then press the '4' key once to produce the letter 'g'; press and release the Orange key and then press the '4' key three times to produce the letter 'i'.</p> <p>Press the SHIFT key in Alpha state to produce the upper case alphabetic characters on the key. For example, press and release the Orange key, press and release the SHIFT key, and then press the '4' key once to produce the letter 'G'; press and release the Orange key, press and release the SHIFT key and then press the '4' key three times to produce the letter 'I'.</p>
<p>Backspace</p> 	<p>Produces a backspace.</p>
<p>SHIFT</p> 	<p>Press and release the SHIFT key to activate the keypad alternate SHIFT functions.</p> <p>A single press displays the following icon at the bottom of the screen, until a second key is pressed: </p> <p>Press the Orange key, then the Shift key to add a temporary shift (that applies only to the next key pressed) to the orange lock state. This displays the following icon at the bottom of the screen: </p>

Table C-7 *Telephony Numeric Keypad Descriptions (Continued)*

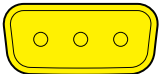
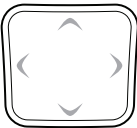





Key	Description
Enter 	Executes a selected item or function.
CTRL 	Press and release the CTRL key to activate the keypad alternate CTRL functions. The  icon appears at the bottom of the screen. Press the Orange key followed by the CTRL key to activate the keypad alternate ALT functions. The  icon appears at the bottom of the screen.
SPACE 	Produces a space character.
ESC 	Exits the current operation.
TAB 	Move from one field to another.

Table C-8 *Telephony Numeric Keypad Input Modes*

Key	Numeric Mode		Orange Key (Alpha Lowercase Mode)				Orange + Shift Keys (Alpha Uppercase Mode)			
		SHIFT + Key	1st Press	2nd Press	3rd Press	4th Press	1st Press	2nd Press	3rd Press	4th Press
1	1	!	@	?			@	?		
2	2	@	a	b	c		A	B	C	
3	3	#	d	e	f		D	E	F	
4	4	\$	g	h	i		G	H	I	
5	5	%	j	k	l		J	K	L	
6	6	^	m	n	o		M	N	O	
7	7	&	p	q	r	s	P	Q	R	S
8	8	*	t	u	v		T	U	V	
9	9	(w	x	y	z	W	X	Y	Z

Note: An application can change the key functions. The keypad may not function exactly as described.

Table C-8 *Telephony Numeric Keypad Input Modes (Continued)*

Key	Numeric Mode		Orange Key (Alpha Lowercase Mode)				Orange + Shift Keys (Alpha Uppercase Mode)			
		SHIFT + Key	1st Press	2nd Press	3rd Press	4th Press	1st Press	2nd Press	3rd Press	4th Press
0	0)	au				au			
,	,	<	,				<			
.	.	>	.				>			
*	*	*	*				*			
-	-	—	-				—			

Note: An application can change the key functions. The keypad may not function exactly as described.

Special Character Key

✓ **NOTE** Special characters are only available on the alpha-numeric keypad configurations.

To add special characters using the MC950-K **áü** key, type the related character first, then press the Orange twice followed by the **áü** key. Continue pressing the **áü** key until the special character displays. To modify an existing character, move the cursor to the right of the character then press the Orange key twice and then press the **áü** key until the special character replaces the original character. [Table C-9](#) lists the special characters you can generate.

Table C-9 Special Characters

Key	Special Characters	Key	Special Characters
a	à á â ã ä å æ	A	À Á Â Ã Ä Å Æ
c	ç ć ċ ©	C	Ç Ć Ć ©
d	ð	D	Ð
e	è é ê ë ě	E	È É Ê Ë Ě
i	ì í î ï	I	Ì Í Î Ï
l	ł	L	Ł
n	ñ	N	Ñ
o	ò ó ô õ ö ø œ	O	Ò Ó Ô Õ Ö Ø Œ
p	þ	P	Þ
r	®	R	®
s	ş š ß	S	Ş Š ß
t	ţ	T	Ţ
u	ù ú û ü ú	U	Ù Ú Û Ü
y	ý	Y	Ý
z	ź ż	Z	Ź Ż
\$	€ £ ¥	/	\
"	' « ' »	([{ < «
)] } > »	+	± & - _
!	! ? ¿	.	! , ;
*	#	@	~ %
%	^	,	; . :
#	*	&	- _ + ±

Table C-9 *Special Characters (Continued)*

Key	Special Characters		Key	Special Characters
_	+ ± & -		'	« » "
?	¿ ! ¡		:	, ; .
-	_ + ± &			

Glossary

A

API. An interface by means of which one software component communicates with or controls another. Usually used to refer to services provided by one software component to another, usually via software interrupts or function calls

Aperture. The opening in an optical system defined by a lens or baffle that establishes the field of view.

Application Programming Interface. See **API**.

ANSI Terminal. A display terminal that follows commands in the ANSI standard terminal language. For example, it uses escape sequences to control the cursor, clear the screen and set colors. Communications programs support the ANSI terminal mode and often default to this terminal emulation for dial-up connections to online services.

ASCII. American Standard Code for Information Interchange. A 7 bit-plus-parity code representing 128 letters, numerals, punctuation marks and control characters. It is a standard data transmission code in the U.S.

Autodiscrimination. The ability of an interface controller to determine the code type of a scanned bar code. After this determination is made, the information content is decoded.

B

Bar. The dark element in a printed bar code symbol.

Bar Code. A pattern of variable-width bars and spaces which represents numeric or alphanumeric data in machine-readable form. The general format of a bar code symbol consists of a leading margin, start character, data or message character, check character (if any), stop character, and trailing margin. Within this framework, each recognizable symbology uses its own unique format. See **Symbology**.

Bar Code Density. The number of characters represented per unit of measurement (e.g., characters per inch).

Bar Height. The dimension of a bar measured perpendicular to the bar width.

Bar Width. Thickness of a bar measured from the edge closest to the symbol start character to the trailing edge of the same bar.

BIOS. Basic Input Output System. A collection of ROM-based code with a standard API used to interface with standard PC hardware.

Bit. Binary digit. One bit is the basic unit of binary information. Generally, eight consecutive bits compose one byte of data. The pattern of 0 and 1 values within the byte determines its meaning.

Bits per Second (bps). Bits transmitted or received.

BOOTP. A protocol for remote booting of diskless devices. Assigns an IP address to a machine and may specify a boot file. The client sends a bootp request as a broadcast to the bootp server port (67) and the bootp server responds using the bootp client port (68). The bootp server must have a table of all devices, associated MAC addresses and IP addresses.

boot or boot-up. The process a computer goes through when it starts. During boot-up, the computer can run self-diagnostic tests and configure hardware and software.

bps. See **Bits Per Second**.

Byte. On an addressable boundary, eight adjacent binary digits (0 and 1) combined in a pattern to represent a specific character or numeric value. Bits are numbered from the right, 0 through 7, with bit 0 the low-order bit. One byte in memory is used to store one ASCII character.

C

CDRH. Center for Devices and Radiological Health. A federal agency responsible for regulating laser product safety. This agency specifies various laser operation classes based on power output during operation.

CDRH Class 1. This is the lowest power CDRH laser classification. This class is considered intrinsically safe, even if all laser output were directed into the eye's pupil. There are no special operating procedures for this class.

CDRH Class 2. No additional software mechanisms are needed to conform to this limit. Laser operation in this class poses no danger for unintentional direct human exposure.

Character. A pattern of bars and spaces which either directly represents data or indicates a control function, such as a number, letter, punctuation mark, or communications control contained in a message.

Character Set. Those characters available for encoding in a particular bar code symbology.

Check Digit. A digit used to verify a correct symbol decode. The scanner inserts the decoded data into an arithmetic formula and checks that the resulting number matches the encoded check digit. Check digits are required for UPC but are optional for other symbologies. Using check digits decreases the chance of substitution errors when a symbol is decoded.

Codabar. A discrete self-checking code with a character set consisting of digits 0 to 9 and six additional characters: ("-", "\$", ".", "/", ",", "+").

Code 128. A high density symbology which allows the controller to encode all 128 ASCII characters without adding extra symbol elements.

Code 3 of 9 (Code 39). A versatile and widely used alphanumeric bar code symbology with a set of 43 character types, including all uppercase letters, numerals from 0 to 9 and 7 special characters (“-”, “.”, “/”, “+”, “%”, “\$” and space). The code name is derived from the fact that 3 of 9 elements representing a character are wide, while the remaining 6 are narrow.

Code 93. An industrial symbology compatible with Code 39 but offering a full character ASCII set and a higher coding density than Code 39.

Code Length. Number of data characters in a bar code between the start and stop characters, not including those characters.

Cold Boot. A cold boot restarts the mobile computer and erases all user stored records and entries.

COM port. Communication port; ports are identified by number, e.g., COM1, COM2.

Continuous Code. A bar code or symbol in which all spaces within the symbol are parts of characters. There are no intercharacter gaps in a continuous code. The absence of gaps allows for greater information density.

Cradle. A cradle is used for charging the terminal battery and for communicating with a host computer, and provides a storage place for the terminal when not in use.

D

Data Communications Equipment (DCE). A device (such as a modem) which is designed to attach directly to a DTE (Data Terminal Equipment) device.

DCE. See **Data Communications Equipment**.

DCP. See **Device Configuration Package**.

Dead Zone. An area within a scanner's field of view, in which specular reflection may prevent a successful decode.

Decode. To recognize a bar code symbology (e.g., UPC/EAN) and then analyze the content of the specific bar code scanned.

Decode Algorithm. A decoding scheme that converts pulse widths into data representation of the letters or numbers encoded within a bar code symbol.

Decryption. Decryption is the decoding and unscrambling of received encrypted data. Also see, **Encryption** and **Key**.

Depth of Field. The range between minimum and maximum distances at which a scanner can read a symbol with a certain minimum element width.

Device Configuration Package. The Symbol Device Configuration Package provides the Product Reference Guide (PRG), flash partitions, Terminal Configuration Manager (TCM) and the associated TCM scripts. With this package hex images that represent flash partitions can be created and downloaded to the mobile computer.

Discrete Code. A bar code or symbol in which the spaces between characters (intercharacter gaps) are not part of the code.

Discrete 2 of 5. A binary bar code symbology representing each character by a group of five bars, two of which are wide. The location of wide bars in the group determines which character is encoded; spaces are insignificant. Only numeric characters (0 to 9) and START/STOP characters may be encoded.

DRAM. Dynamic random access memory.

DTE. See **Data Terminal Equipment**.

E

EAN. European Article Number. This European/International version of the UPC provides its own coding format and symbology standards. Element dimensions are specified metrically. EAN is used primarily in retail.

Element. Generic term for a bar or space.

Encoded Area. Total linear dimension occupied by all characters of a code pattern, including start/stop characters and data.

ENQ (RS-232). ENQ software handshaking is also supported for the data sent to the host.

ESD. Electro-Static Discharge

F

File Transfer Protocol (FTP). A TCP/IP application protocol governing file transfer via network or telephone lines. See **TCP/IP**.

Flash Disk. An additional megabyte of non-volatile memory for storing application and configuration files.

Flash Memory. Flash memory is nonvolatile, semi-permanent storage that can be electronically erased in the circuit and reprogrammed. Series 9000 mobile computers use Flash memory to store the operating system (ROM-DOS), the terminal emulators, and the Citrix ICA Client for DOS.

FTP. See **File Transfer Protocol**.

H

Hard Reset. See **Cold Boot**.

Hz. Hertz; A unit of frequency equal to one cycle per second.

Host Computer. A computer that serves other terminals in a network, providing such services as computation, database access, supervisory programs and network control.

I

IDE. Intelligent drive electronics. Refers to the solid-state hard drive type.

IEC. International Electrotechnical Commission. This international agency regulates laser safety by specifying various laser operation classes based on power output during operation.

IEC (825) Class 1. This is the lowest power IEC laser classification. Conformity is ensured through a software restriction of 120 seconds of laser operation within any 1000 second window and an automatic laser shutdown if the scanner's oscillating mirror fails.

IEEE Address. See **MAC Address**.

Input/Output Ports. I/O ports are primarily dedicated to passing information into or out of the mobile computer's memory. Series 9500 mobile computers include a USB port.

Interleaved 2 of 5. A binary bar code symbology representing character pairs in groups of five bars and five interleaved spaces. Interleaving provides for greater information density. The location of wide elements (bar/spaces) within each group determines which characters are encoded. This continuous code type uses no intercharacter spaces. Only numeric (0 to 9) and START/STOP characters may be encoded.

Intercharacter Gap. The space between two adjacent bar code characters in a discrete code.

Interleaved Bar Code. A bar code in which characters are paired together, using bars to represent the first character and the intervening spaces to represent the second.

Internet Protocol Address. See **IP**.

IOCTL. Input/Output Control.

I/O Ports. interface The connection between two devices, defined by common physical characteristics, signal characteristics, and signal meanings. Types of interfaces include RS-232 and PCMCIA.

IP. Internet Protocol. The IP part of the TCP/IP communications protocol. IP implements the network layer (layer 3) of the protocol, which contains a network address and is used to route a message to a different network or subnetwork. IP accepts "packets" from the layer 4 transport protocol (TCP or UDP), adds its own header to it and delivers a "datagram" to the layer 2 data link protocol. It may also break the packet into fragments to support the maximum transmission unit (MTU) of the network.

IP Address. (Internet Protocol address) The address of a computer attached to an IP network. Every client and server station must have a unique IP address. A 32-bit address used by a computer on a IP network. Client workstations have either a permanent address or one that is dynamically assigned to them each session. IP addresses are written as four sets of numbers separated by periods; for example, 204.171.64.2.

IPX/SPX. Internet Package Exchange/Sequential Packet Exchange. A communications protocol for Novell. IPX is Novell's Layer 3 protocol, similar to XNS and IP, and used in NetWare networks. SPX is Novell's version of the Xerox SPP protocol.

IS-95. Interim Standard 95. The EIA/TIA standard that governs the operation of CDMA cellular service. Versions include IS-95A and IS-95B. See CDMA.

K

Key. A key is the specific code used by the algorithm to encrypt or decrypt the data. Also see, **Encryption** and **Decrypting**.

L

LASER. Light Amplification by Stimulated Emission of Radiation. The laser is an intense light source. Light from a laser is all the same frequency, unlike the output of an incandescent bulb. Laser light is typically coherent and has a high energy density.

Laser Diode. A semiconductor type of laser connected to a power source to generate a laser beam. This laser type is a compact source of coherent light.

laser scanner. A type of bar code reader that uses a beam of laser light.

LCD. See **Liquid Crystal Display**.

LED Indicator. A semiconductor diode (LED - Light Emitting Diode) used as an indicator, often in digital displays. The semiconductor uses applied voltage to produce light of a certain frequency determined by the semiconductor's particular chemical composition.

Light Emitting Diode. See **LED**.

Liquid Crystal Display (LCD). A display that uses liquid crystal sealed between two glass plates. The crystals are excited by precise electrical charges, causing them to reflect light outside according to their bias. They use little electricity and react relatively quickly. They require external light to reflect their information to the user.

M

MC. Mobile Computer.

MDN. Mobile Directory Number. The directory listing telephone number that is dialed (generally using POTS) to reach a mobile unit. The MDN is usually associated with a MIN in a cellular telephone -- in the US and Canada, the MDN and MIN are the same value for voice cellular users. International roaming considerations often result in the MDN being different from the MIN.

MIL. 1 mil = 1 thousandth of an inch.

MIN. Mobile Identification Number. The unique account number associated with a cellular device. It is broadcast by the cellular device when accessing the cellular system.

Misread (Misdecode). A condition which occurs when the data output of a reader or interface controller does not agree with the data encoded within a bar code symbol.

Mobile Computer. In this text, *mobile computer* refers to the Symbol Series 9000 wireless portable computer. It can be set up to run as a stand-alone device, or it can be set up to communicate with a network, using wireless radio technology.

N

Nominal. The exact (or ideal) intended value for a specified parameter. Tolerances are specified as positive and negative deviations from this value.

Nominal Size. Standard size for a bar code symbol. Most UPC/EAN codes are used over a range of magnifications (e.g., from 0.80 to 2.00 of nominal).

NVM. Non-Volatile Memory.

O

ODI. See **Open Data-Link Interface**.

Open Data-Link Interface (ODI). Novell's driver specification for an interface between network hardware and higher-level protocols. It supports multiple protocols on a single NIC (Network Interface Controller). It is capable of understanding and translating any network information or request sent by any other ODI-compatible protocol into something a NetWare client can understand and process.

Open System Authentication. Open System authentication is a null authentication algorithm.

P

PAN . Personal area network. Using Bluetooth wireless technology, PANs enable devices to communicate wirelessly. Generally, a wireless PAN consists of a dynamic group of less than 255 devices that communicate within about a 33-foot range. Only devices within this limited area typically participate in the network.

Parameter. A variable that can have different values assigned to it.

PC Card. A plug-in expansion card for laptop computers and other devices, also called a PCMCIA card. PC Cards are 85.6mm long x 54 mm wide, and have a 68 pin connector. There are several different kinds:

Type I; 3.3 mm high; use - RAM or Flash RAM

Type II; 5 mm high; use - modems, LAN adaptors

Type III; 10.5 high; use - Hard Disks

PCMCIA. Personal Computer Memory Card Interface Association. See **PC Card**.

Percent Decode. The average probability that a single scan of a bar code would result in a successful decode. In a well-designed bar code scanning system, that probability should approach near 100%.

PING. (Packet Internet Groper) An Internet utility used to determine whether a particular IP address is online. It is used to test and debug a network by sending out a packet and waiting for a response.

Print Contrast Signal (PCS). Measurement of the contrast (brightness difference) between the bars and spaces of a symbol. A minimum PCS value is needed for a bar code symbol to be scannable. $PCS = (RL - RD) / RL$, where RL is the reflectance factor of the background and RD the reflectance factor of the dark bars.

Programming Mode. The state in which a scanner is configured for parameter values. See **Scanning Mode**.

Q

Quiet Zone. A clear space, containing no dark marks, which precedes the start character of a bar code symbol and follows the stop character.

QWERTY. A standard keyboard commonly used on North American and some European PC keyboards. "QWERTY" refers to the arrangement of keys on the left side of the third row of keys.

R

RAM. Random Access Memory. Data in RAM can be accessed in random order, and quickly written and read.

Reflectance. Amount of light returned from an illuminated surface.

Resolution. The narrowest element dimension which is distinguished by a particular reading device or printed with a particular device or method.

RF. Radio Frequency.

ROM. Read-Only Memory. Data stored in ROM cannot be changed or removed.

Router. A device that connects networks and supports the required protocols for packet filtering. Routers are typically used to extend the range of cabling and to organize the topology of a network into subnets. See **Subnet**.

RS-232. An Electronic Industries Association (EIA) standard that defines the connector, connector pins, and signals used to transfer data serially from one device to another.

S

Scan Area. Area intended to contain a symbol.

Scanner. An electronic device used to scan bar code symbols and produce a digitized pattern that corresponds to the bars and spaces of the symbol. Its three main components are: 1) Light source (laser or photoelectric cell) - illuminates a bar code; 2) Photodetector - registers the difference in reflected light (more light reflected from spaces); 3) Signal conditioning circuit - transforms optical detector output into a digitized bar pattern.

Scanning Mode. The scanner is energized, programmed and ready to read a bar code.

Scanning Sequence. A method of programming or configuring parameters for a bar code reading system by scanning bar code menus.

SDK. Software Development Kit

Self-Checking Code. A symbology that uses a checking algorithm to detect encoding errors within the characters of a bar code symbol.

Shared Key. Shared Key authentication is an algorithm where both the AP and the MU share an authentication key.

SHIP. Symbol Host Interface Program.

SID. System Identification code. An identifier issued by the FCC for each market. It is also broadcast by the cellular carriers to allow cellular devices to distinguish between the home and roaming service.

SMDK. Symbol Mobility Developer's Kit.

Soft Reset. See **Warm Boot**.

Space. The lighter element of a bar code formed by the background between bars.

Specular Reflection. The mirror-like direct reflection of light from a surface, which can cause difficulty decoding a bar code.

Start/Stop Character. A pattern of bars and spaces that provides the scanner with start and stop reading instructions and scanning direction. The start and stop characters are normally to the left and right margins of a horizontal code.

STEP. Symbol Terminal Enabler Program.

Subnet. A subset of nodes on a network that are serviced by the same router. See **Router**.

Subnet Mask. A 32-bit number used to separate the network and host sections of an IP address. A custom subnet mask subdivides an IP network into smaller subsections. The mask is a binary pattern that is matched up with the IP address to turn part of the host ID address field into a field for subnets. Default is often 255.255.255.0.

Substrate. A foundation material on which a substance or image is placed.

SVTP. Symbol Virtual Terminal Program.

Symbol. A scannable unit that encodes data within the conventions of a certain symbology, usually including start/stop characters, quiet zones, data characters and check characters.

Symbol Aspect Ratio. The ratio of symbol height to symbol width.

Symbol Height. The distance between the outside edges of the quiet zones of the first row and the last row.

Symbol Length. Length of symbol measured from the beginning of the quiet zone (margin) adjacent to the start character to the end of the quiet zone (margin) adjacent to a stop character.

Symbology. The structural rules and conventions for representing data within a particular bar code type (e.g. UPC/EAN, Code 39, PDF417, etc.).

T

TCP/IP. (Transmission Control Protocol/Internet Protocol) A communications protocol used to internetwork dissimilar systems. This standard is the protocol of the Internet and has become the global standard for communications. TCP provides transport functions, which ensures that the total amount of bytes sent is received correctly at the other end. UDP is an alternate transport that does not guarantee delivery. It is widely used for real-time voice and video transmissions where erroneous packets are not retransmitted. IP provides the routing mechanism. TCP/IP is a routable protocol, which means that all messages contain not only the address of the destination station, but the address of a destination network. This allows TCP/IP messages to be sent to multiple networks within an organization or around the world, hence its use in the worldwide Internet. Every client and server in a TCP/IP network requires an IP address, which is either permanently assigned or dynamically assigned at startup.

Telnet. A terminal emulation protocol commonly used on the Internet and TCP/IP-based networks. It allows a user at a terminal or computer to log onto a remote device and run a program.

Terminal. See **Mobile Computer**.

Terminal Emulation. A "terminal emulation" emulates a character-based mainframe session on a remote non-mainframe terminal, including all display features, commands and function keys. The VC5000 Series supports Terminal Emulations in 3270, 5250 and VT220.

Terminate and Stay Resident (TSR). A program under DOS that ends its foreground execution to remain resident in memory to service hardware/software interrupts, providing background operation. It remains in memory and may provide services on behalf of other DOS programs.

TFTP. (Trivial File Transfer Protocol) A version of the TCP/IP FTP (File Transfer Protocol) protocol that has no directory or password capability. It is the protocol used for upgrading firmware, downloading software and remote booting of diskless devices.

Tolerance. Allowable deviation from the nominal bar or space width.

Transmission Control Protocol/Internet Protocol. See **TCP/IP**.

Trivial File Transfer Protocol. See **TFTP**.

TSR. See **Terminate and Stay Resident**.

U

UDP. User Datagram Protocol. A protocol within the IP protocol suite that is used in place of TCP when a reliable delivery is not required. For example, UDP is used for real-time audio and video traffic where lost packets are simply ignored, because there is no time to retransmit. If UDP is used and a reliable delivery is required, packet sequence checking and error notification must be written into the applications.

UPC. Universal Product Code. A relatively complex numeric symbology. Each character consists of two bars and two spaces, each of which is any of four widths. The standard symbology for retail food packages in the United States.

V

Visible Laser Diode (VLD). A solid state device which produces visible laser light.

W

Warm Boot. A warm boot restarts the mobile computer by closing all running programs. All data that is not saved to flash memory is lost.

Index

Numerics

- 1-D bar codes 4-1
- 2-D bar codes 4-5

A

accessories

- auto charge cable 8-2
 - cables 8-16
 - communication/charge cables
 - battery charging 8-17
 - DEX cable 8-2
 - four bay charge only cradle 8-1, 8-7
 - four bay Ethernet cradle 8-1, 8-9
 - four slot spare battery charger 8-1, 8-11
 - holster 8-2
 - magnetic stripe reader 8-14
 - microSD 1-3
 - MSR 8-14
 - installation 8-14
 - magnetic stripe reading 8-14
 - SIM card 1-4
 - single bay USB cradle 8-1, 8-4
 - spare battery 8-1
 - specifications A-7
 - universal wall mounting bracket, cradle 8-2
 - vehicle cradle 8-12
- Acoustic Echo Cancellation B-2
- action button 3-7
- ActiveSync
 - icon 3-14
- adaptive frequency hopping 7-1
- adjusting volume 3-20
- AFH 7-1
- alpha numeric keypad C-6
 - input modes C-8

- key descriptions C-7
- alpha primary keypad C-2
 - input modes C-4
 - key descriptions C-3
- answering a call 5-10
- auto charge cable 8-2, 8-16

B

bar codes

- one dimensional 4-1
- two dimensional 4-5

battery

- charging 1-6, 8-4, 8-6, 8-7, 8-9, 8-11, 8-12
- installing 1-6
- removing 1-8

battery chargers

- communication/charge cables 8-17
- four slot 8-11

battery charging

- communication/charge cables 8-17
- using four bay charge only cradle 8-7
- using four bay Ethernet cradle 8-9
- using four slot spare battery charger 8-11
- using single bay USB cradle 8-4, 8-6
- using vehicle cradle 8-12

battery functionality

- 2-1

battery icon

- 3-13, 3-20

battery status LED

- 1-7, 3-1

Bluetooth

- adaptive frequency hopping 7-1
- bonding 7-34
- deleting bonded device 7-35
- security 7-2
- turning off 7-5, 7-17
- turning on 7-5, 7-17

bluetooth

- discovering devices 7-6, 7-18
- icon 3-14
- turning on and off 7-5, 7-17
- bonding
 - Bluetooth 7-34
- boot
 - cold 3-3, 7-4
 - warm 3-3, 7-4
- bullets xvii
- buttons
 - action 3-7
 - function 3-7
 - power 3-3, 3-7
 - scan 3-7
 - up and down 3-7

C

- cables 8-16
 - auto charge cable 8-2
 - connecting 8-17
 - DEX cable 8-2
- calculator numeric keypad C-10
 - input modes C-12
 - key descriptions C-11
- calibrating the screen 1-8
- call history 5-12, 5-16
- CDMA
 - data connection 5-30
- charge only cradle 8-1
- charging
 - spare batteries 2-11, 8-11
 - using four bay charge only cradle 8-7
 - using four bay Ethernet cradle 8-9
 - using four slot spare battery charger 8-11
 - using single bay USB cradle 8-4, 8-6
 - using vehicle cradle 8-12
- charging error 1-7
- charging indicators 3-1
- charging temperature 1-7, 2-12, 8-6, 8-13
- charging the battery
 - vehicle battery charger 8-13
- cleaning 9-1
- cold boot 3-3, 7-4
- command bar 3-14
 - icons 3-14
- communication 8-16
- communication/charge cables 8-16
 - battery charging 8-17
- conference call 5-21, 5-23
- configuration xiv
- connectivity icon 3-12
- contacts
 - creating a contact 5-7, 5-8

- deleting a contact 5-8
- editing a contact 5-7
- contacts application 5-6
- conventions
 - notational xvii
- cradles
 - four bay charge only 8-1, 8-7
 - four bay Ethernet 8-1, 8-9
 - four slot spare battery charger 8-11
 - single bay USB 8-4
 - vehicle 8-12

D

- data capture xiv
 - imager operational modes
 - decode mode 4-6
 - image capture mode 4-6
 - pick list mode 4-6
 - imaging 4-5
 - laser scanning 4-1
 - one dimensional bar codes 4-1
 - scan angle 4-2
 - scan button 3-7
 - scan range 4-1
 - scanning 4-2, 4-6, 4-9
 - two dimensional bar codes 4-5
- data connection 5-30
- decode distances
 - imager 4-9
 - laser scanner 4-5
- decode LED 3-1
- decode ranges 4-8
- decode zone
 - laser scanner 35° 4-3
 - laser scanner 47° 4-4
- deleting Bluetooth bond 7-35
- DEX cable 8-2
- disconnecting 5-29, 5-30
- display xiv

E

- emergency calls 5-9
- ESD 1-3
- Ethernet cradle 8-1, 8-9
- Evolution Data-Optimized 5-1

F

- four bay charge only cradle 8-7
 - charging 8-7
- four bay Ethernet cradle 8-9
 - charging 8-9

- link indicator 8-10
- speed indicator 8-10
- four slot spare battery charger 8-1, 8-11
 - charging 8-11
 - setup 8-11
- function buttons 3-7

G

- GPRS
 - data connection 5-28
 - data disconnect 5-29, 5-30
- GSM
 - GPRS data connection 5-28

H

- HAC 5-5
- handset B-2
- hard reset 3-3, 7-4
- headset 5-3, 5-4
- hearing aid compatibility 5-5
- High-Speed Downlink Packet Access 5-1
- holster 8-2

I

- icons
 - ActiveSync 3-14
 - battery 3-13, 3-20
 - bluetooth 3-14
 - connectivity 3-12
 - phone 3-13
 - speaker 3-13, 3-20
 - status 3-11
 - task tray 3-14
 - time and appointment 3-13
 - wireless status 3-14
- imager decode distances 4-9
- imager. *See* data capture, imaging
- imaging 4-5
- information, service xviii
- installing battery 1-6
- installing microSD card 1-3
- internet
 - disconnecting GPRS 5-29, 5-30
 - via GPRS 5-28
 - wireless connection 5-30

K

- key descriptions
 - alpha numeric keypad C-7
 - alpha primary keypad C-3

- calculator numeric keypad C-11
- telephony numeric keypad C-15
- keypads xiv
 - alpha numeric C-6
 - alpha primary C-2
 - calculator numeric C-10
 - input modes C-4, C-8, C-12, C-16
 - key descriptions C-3, C-7, C-11, C-15
 - phone 5-1
 - special character key C-18
 - telephony numeric C-14
 - types 3-6, C-1

L

- LEDs 3-1
 - battery status 3-2
 - charging 3-2
 - radio status 3-2
 - scan and decode 3-1, 4-2, 4-6, 4-10
- lithium-ion battery 1-1
- locking the MC9500-K keypad 3-4

M

- magnetic stripe reader 8-14
 - installation 8-14
 - magnetic stripe reading 8-14
- main battery
 - charging 1-3
 - installing 1-3
- maintenance 9-1
- memory xiv
- microSD 1-3
 - microSD card 1-3, 1-9
 - installation 1-3
 - removal 1-9
- MSR 8-14
 - installation 8-14
 - magnetic stripe reading 8-14
- muting a call 5-12

N

- navigation bar
 - icons 3-11
- notational conventions xvii
- notes application 5-12
- notification icons 3-11

O

- operating environment A-1
- operating system xiv

P

- passwords 3-5
 - hint 3-5
- phone
 - answering a call 5-10
 - call history 5-16
 - call swapping 5-20
 - conference call 5-21, 5-23
 - contacts 5-6
 - keypad 5-1
 - muting a call 5-12
 - speed dial
 - adding entry 5-13
 - calling 5-9
 - deleting entry 5-16
 - editing entry 5-15
 - taking notes 5-12
 - text messaging 5-24
 - three-way call 5-21, 5-23
 - using keypad 5-6
- phone icon 3-13
- power button 3-3, 3-7

R

- radiosxiv
- removing main battery 1-8
- reset 3-3
 - hard 3-3, 7-4
 - soft 3-3, 7-4
- resume 7-5
- rigid holster 8-2

S

- scan button 3-7
- scanning
 - button 3-7
 - imaging 4-5
- scanning with digital camera 4-9
- screen
 - calibration 1-8
- security
 - Bluetooth 7-2
- service information xviii
- SIM card 1-9
 - accessories 1-4
 - installation 1-4
 - removal 1-9
- single bay USB cradle 8-1, 8-4
 - charging 8-4, 8-6
- soft reset 3-3, 7-4
- spare battery 8-1

- charging 2-11, 8-11
- spare battery charger
 - charging 8-11
 - setup 8-11
- speaker icon 3-13, 3-20
- special character key C-18
- speed dial 5-9, 5-13
- starting the MC9500-K 1-8
- status icon 3-11
 - battery 3-13, 3-20
 - connectivity 3-12
 - phone 3-13
 - speaker 3-13, 3-20
 - time and appointment 3-13
- strap 1-1
- stylus 1-1, 3-7
- subscriber identification module 1-4
- suspend 1-8, 7-4
- synchronize with PC
 - using Bluetooth 7-13

T

- task tray icons 3-14
- technical specifications A-1
 - accessories A-7
- telephony numeric keypad C-14
 - input modes C-16
 - key descriptions C-15
- temperature A-2
 - charging 1-7, 2-12, 8-6, 8-13
- three-way call 5-21, 5-23
- time and appointment icon 3-13
- Today screen 3-11
- troubleshooting 9-6
- turn off radios 2-13

U

- universal wall mounting bracket, cradle 8-2
- unpacking 1-1
- up and down button 3-7
- USB charging cable 8-16
- USB client charge cable 8-16
- using stylus 3-7
- using wired headset 5-3, 5-4

V

- vehicle battery charger 8-13
- vehicle cradle 8-12
- Voice Quality Manager B-1
- VQM B-1
 - disabling B-4

enabling B-1

W

wakeup conditions 3-3
waking MC9500-K 3-3
WAN radio status LED 3-1
warm boot 3-3, 7-4
wired headset 5-3, 5-4
Wireless 2-13, 5-2
wireless
 internet 5-30
Wireless Manager 2-13, 5-2
wireless status 3-14
WLAN 802.11a/b/gxiv
WPAN Bluetoothxiv



MOTOROLA

Motorola, Inc.
One Motorola Plaza
Holtsville, New York 11742, USA
1-800-927-9626
<http://www.motorola.com/enterprisemobility>

MOTOROLA and the Stylized M Logo and Symbol and the Symbol logo are registered in the U.S. Patent and Trademark Office.
All other product or service names are the property of their registered owners.
© Motorola, Inc. 2009