

PA550 Rugged Mobile Computer

- PA550 -



User's Manual

400822G Version 1.0

About This Manual

This manual explains how to install, operate and maintain the PA550 Rugged Mobile Computer.

No part of this publication may be reproduced or used in any form, or by any electrical or mechanical means, without permission in writing from the manufacturer. This includes electronic or mechanical means, such as photocopying, recording, or information storage and retrieval systems. The material in this manual is subject to change without notice.

© Copyright 2010 Unitech Electronics Co., Ltd. All rights reserved.

Unitech global website address: <http://www.unitech-adc.com>

Bluetooth is a registered trademark of Bluetooth SIG.



Microsoft, Windows and ActiveSync are either registered trademarks or trademarks of Microsoft Corporation. Other product names mentioned in this manual may be trademarks or Registered trademarks of their respective companies and are hereby acknowledged.



Unitech is a member of Oracle Embedded Software Licensing Program.

Regulatory Compliance Statements

FCC Warning Statement

This equipment has been tested and found to comply with the limits for a Class B digital device, pursuant to part 15 of the FCC rules. These limits are designed to provide reasonable protection against harmful interference in a residential installation. This equipment generates, uses and can radiate radio frequency energy and, if not installed and used in accordance with the instructions, may cause harmful interference to radio communications. However, there is no guarantee that interference will not occur in a particular installation. If this equipment does cause harmful interference to radio or television reception, which can be determined by turning the equipment off and on, the user is encouraged to try to correct the interference by one or more of the following measures:

- Reorient or relocate the receiving antenna.
 - Increase the separation between the equipment and receiver.
 - Connect the equipment into an outlet on a circuit different from that to which the receiver is connected.
 - Consult the dealer or an experienced radio/TV technician for help.
1. This Transmitter must not be co-located or operating in conjunction with any other antenna or transmitter.
 2. This equipment complies with FCC RF radiation exposure limits set forth for an uncontrolled environment. To maintain compliance with FCC RF exposure compliance requirements, avoid direct contact to the transmitting antenna during transmitting.
 3. Any changes or modifications (including the antennas) made to this device that are not expressly approved by the manufacturer may void the user's authority to operate the equipment.

FCC Label Statement

This device complies with part 15 of the FCC rules. Operation is subject to the following two conditions:

1. This device may not cause harmful interference, and
2. This device must accept any interference received, including interference that may cause undesired operation.

RF Radiation Exposure Statement

For body worn operation, this phone has been tested and meets FCC RF exposure guidelines when used with an accessory that contains no metal and that positions the handset a minimum of 1.5 cm from the body. Use of other accessories may not ensure compliance with FCC RF exposure guidelines.

Canadian Compliance Statement

This Class B Digital apparatus meets all requirements of the Canadian Interference-Causing Equipment Regulations.

Cet appareil numérique de la classe B respecte les exigences du Règlement sur le matériel brouilleur du Canada.

European Conformity Statement

Declaration of Conformity with Regard to the R&TTE 1999/5/EC and EMC 89/336/ EEC directives.

RoHS Statement



This device conforms to RoHS (Reduction Of Hazardous Sub-stances) European Union regulations that set maximum concentration limits on hazardous materials used in electrical and electronic equipment.

TaiwanNCC Warning Statement

交通部電信總局低功率電波輻射性電機管理辦法 (930322)

根據交通部低功率管理辦法規定：

第十二條 經型式認證合格之低功率射頻電機，非經許可，公司、商號或使用者均不得擅自變更頻率、加大功率或變更原設計之特性及功能。

第十四條 低功率射頻電機之使用不得影響飛航安全及干擾合法通信；經發現有干擾現象時，應立即停用，並改善至無干擾時方得繼續使用。前項合法通信，指依電信法規定作業之無線電通信。

低功率射頻電機須忍受合法通信或工業、科學及醫療用電波輻射性電機設備之干擾。

Laser Information

The Unitech PA550 series is certified in the U.S. to conform to the requirements of DHHS/CDRH 21CFR Subchapter J and to the requirements of IEC 825-1. Class II and Class 2 products are not considered to be hazardous. The PA600 series contains internally a Visible Laser Diode (VLD) whose emissions do not exceed the maximum limits as set forth in the above regulations. The scanner is designed so that there is no human access to harmful laser light during normal operation, user maintenance or during prescribed service operations.

The laser safety warning label required by the DHHS/IEC for the PA600 series' optional laser scanner module is located on the memory compartment cover, on the back of the unit.

CAUTION! Use of controls or adjustments or performance of procedures other than those specified herein may result in hazardous laser light. Use of optical instruments with the scanner will increase eye hazard. Optical instruments include binoculars, microscopes, and magnifying glasses. This does not include eyeglasses worn by the user.

Battery Notices

The PA550 is equipped with a Lithium-Ion battery pack and backup battery. Both batteries will discharge after an extended period of not being used.

When both batteries are discharged, recharge the unit for 16 hours in order to fully charge the main battery and backup battery. Recharge the PA550 through the following:

1. Plug the USB charging cable to the PA550 and plug the 5V/3A AC-DC adapter to the power jack of the USB charging cable.
2. Place the PA550 into the docking station and plug the 5V/3A AC-DC adapter to the power jack of the docking station.

If the main battery is removed, the backup battery ensures the data on SDRAM is safe for up to 6 hours. To prevent data loss, do not leave the PA550 uncharged with the main battery removed for an extended period. See Charging the Battery on page 8 for more details.

Note: Rechargeable batteries are advised to replace every year or when 500 charge/discharge cycles achieved to guarantee optimal performance. It is normal that the battery balloons or expands beyond one year or the maximum of 500 cycles. Although it does not cause harm, it cannot be used again and must be disposed of according to the location's safe battery disposal procedures.

If the performance decrease is greater than 20% in a Lithium-Ion battery, the battery is at the end of its life cycle. Do not continue to use, and ensure the battery is disposed of properly.

The length of time that a battery power lasts depends on the battery type and how the device is used. Conserve the battery life through the following:

- Avoid frequent full discharges because this places additional strain on the battery. Several partial discharges with frequent recharges are better than a deep one. Recharging a partially charged lithium-Ion battery does not cause harm because there is no memory.
- Keep the lithium-Ion battery cool. Avoid a hot car. For prolonged storage, keep the battery at a 40% charge level.
- Do not leave the lithium-Ion battery discharged and unused for an extended period because the battery will wear out and the longevity of the battery will be at least shorter than half of the one with frequent recharges.

Battery charge notice

It is important to consider the environment temperature whenever the Lithium-Ion battery pack is charged. Charging is most efficient at normal room temperature or in a slightly cooler environment. It is essential that batteries are charged within the stated range of 10°C to 45°C. Charging batteries outside of the specified range could damage the batteries and shorten their charging life cycle.

CAUTION! Do not charge batteries at a temperature lower than 0°C, which will increase the internal resistance to cause heat and make the batteries unstable and unsafe. Please use a battery temperature detecting device for a charger to ensure a safe charging temperature range.

Storage and safety notice

Although charged Lithium-Ion batteries may be left unused for several months, their capacity may be depleted due to build up of internal resistance. If this happens they will require recharging prior to use. Lithium-Ion batteries may be stored at temperatures between -20°C to 60°C, however they may deplete more rapidly at the higher temperature ranges. It is recommended to store batteries within normal room temperature ranges.

Warranty

The following items covered under Unitech Limited Warranty are free from defects during normal use:

- PA550 – 1-year limited warranty.
- Lithium-Ion battery – 6-month limited warranty.

Warranty becomes void if equipment is modified, improperly installed or used, damaged by accident or neglect, or if any parts are improperly installed or replaced by the user.

Use only the adapter supplied. Using the wrong adapter may damage the unit and will void the warranty.

Table of Contents

PREFACE

About This Manual	i
--------------------------------	----------

REGULATORY COMPLIANCE STATEMENTS.....	II
---------------------------------------	----

<i>FCC Warning Statement</i>	<i>ii</i>
------------------------------------	-----------

<i>FCC Label Statement</i>	<i>ii</i>
----------------------------------	-----------

<i>RF Radiation Exposure Statement</i>	<i>iii</i>
--	------------

<i>Canadian Compliance Statement</i>	<i>iii</i>
--	------------

<i>European Conformity Statement</i>	<i>iii</i>
--	------------

<i>RoHS Statement</i>	<i>iii</i>
-----------------------------	------------

<i>TaiwanNCC Warning Statement</i>	<i>iii</i>
--	------------

LASER INFORMATION	IV
-------------------------	----

BATTERY NOTICES	IV
-----------------------	----

<i>Battery charge notice</i>	<i>v</i>
------------------------------------	----------

<i>Storage and safety notice</i>	<i>vi</i>
--	-----------

WARRANTY	VI
----------------	----

Chapter 1

Getting Started	1
------------------------------	----------

INTRODUCING THE PA550	1
-----------------------------	---

FEATURES.....	2
---------------	---

PACKAGE CONTENTS	3
------------------------	---

TOUR OF THE PA550	3
-------------------------	---

<i>Front/Bottom/Top Views</i>	<i>3</i>
-------------------------------------	----------

<i>Rear View</i>	<i>4</i>
------------------------	----------

<i>Right View</i>	5
<i>Left View</i>	5
SETTING UP THE PA550	5
<i>Installing the Battery</i>	6
<i>Charging the Battery</i>	8
<i>Connecting the terminal to a host (PC/ Notebook)</i>	9
<i>Turning the terminal on for the first time</i>	9
Chapter 2	
Using the Hardware	13
USING THE MICROSD MEMORY CARD	13
<i>Inserting a Storage Card</i>	13
<i>Removing the Storage Card</i>	14
USING THE SIM CARD.....	14
<i>Inserting the SIM card</i>	14
USING THE BARCODE LASER SCANNER	14
Chapter 3	
Getting Connected.....	17
ESTABLISHING DEVICE-PC CONNECTION.....	17
<i>Installing Microsoft ActiveSync</i>	17
<i>Connecting the Device to Your Computer</i>	18
Chapter 4	
Barcode Scanner Programs.....	19
SCANNER SETTING	19
SCAN2KEY.....	19
<i>Barcode Symbologies</i>	20

Chapter 5

Advanced Settings.....23

PERFORMING A HARDWARE RESET23

Performing a Warm Boot23

Performing a Cold Boot23

Appendix I

System Specification25

Appendix II

Worldwide Support27

Getting Started

Introducing the PA550

Thank you for purchasing the PA550 Rugged Mobile Computer.

Your PA550 was designed for users who need a compact and durable mobile computer for data collection and real time transactions.

The PA550 is a rugged, compact and lightweight palm-size mobile computer using Windows Mobile 6.5 operating system, and incorporating an integral bar code scanning device, advanced fingerprint reader, high-resolution digital camera, color LCD with touchscreen, and keypad. It provides users with a standard Windows-based environment for customizing and operating the device.

To reduce TCO, the PA550 is sealed to meet IP65 standards and has undergone multiple drop tests to prevent downtime.



Features

Powerful system

- Microsoft Windows Mobile 6.5 operating system
- Intel PXA270 processor with speed of up to 520 MHz

System memory

- 128 MB SDRAM

320 MB Flash ROM

Display

- 5" TFT LCD panel with touch-sensitive screen
- 240 x 320 resolution
- Supports display rotation
- Polycarbon LCD protection foil (Pre-installed)

Barcode scanner

- Built-in Symbol SE-950 Scan Engine

Communication

- USB 1.1 Host & Client
- 802.11b/g
- Bluetooth 2.0 EDR (supports Blue-tooth Printer, Bluetooth Modem, Bluetooth ActiveSync)
- Integrated WPAN/WLAN/WWAN

Audio

- MIC
- Speaker
- Headset connector
- Receiver

Picture Capture

- Built-in 2.0M Pixel camera
- 1/4-inch CMOS sensor

Fingerprint Reader

- Resolution 500 DPI
- 256 gray scale
- Fingerprint image
- Live finger verification

Expansion slot

- SD memory slot, supports up to 2G

Wireless connectivity

- 802.11b/g
- Bluetooth

Battery life

- Standby above 24 hours
- With BT ON: above 4 hours
- Charging time: 4 hours
- Embedded backup battery cell

User-friendly interface

- Special keys to launch particular applications and display the on-screen keyboard
- Keys for barcode scanning

Package Contents

There must be following contents in the package box:

PA550 terminal x 1	Battery x 1
Stylus cord x 1	Stylus x 1
Hand strap x 1	USB Cable x 1
Adaptor x 1	User manual CD x 1

If anything is missing or appear damaged in any way, contact your dealer.

Tour of the PA550

The following sections describe the main components and features of the PA550.

Front/Bottom/Top Views

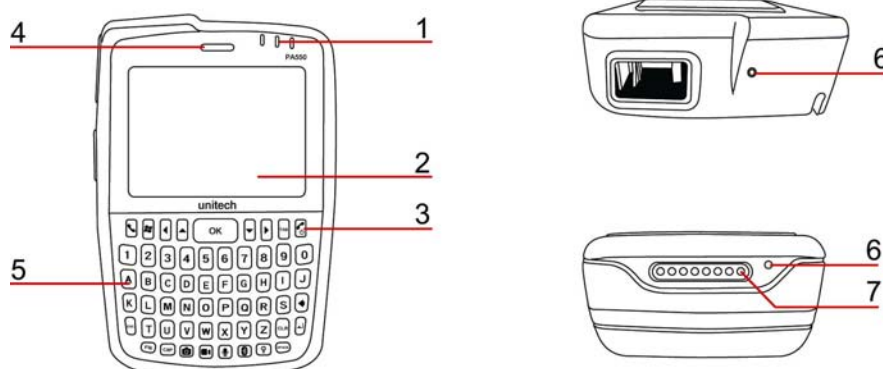

No.	Name	Description
1	Status indicator	Indicating the status of battery charging and barcode scanning Green: indicating that the battery is fully charged or barcode scanning is successful Red: indicating that the battery is being charged or a barcode is being scanned. The leftmost indicating lamp is for GSM transmission.
2	LCD Touch screen	Showing the data in the terminal and being controllable by a finger or stylus
3	Power button	Powering ON the terminal when being turned OFF. When

No.	Name	Description
		the terminal is working, press and hold the button for 3 seconds to power OFF the terminal.
4	Receiver	
5	Keypad	Alphanumeric and command input to the terminal
6	Microphone	Audio input for recording
7	Universal connector	A connector for a USB cable of which one end is connected to a USB port of a PC to transmit 5V power to the terminal and simultaneously help battery charging and data synchronization. The connector may be connected to an external hardware device, such as a cradle, a USB/RS232 scanner, or a keyboard.

Rear View

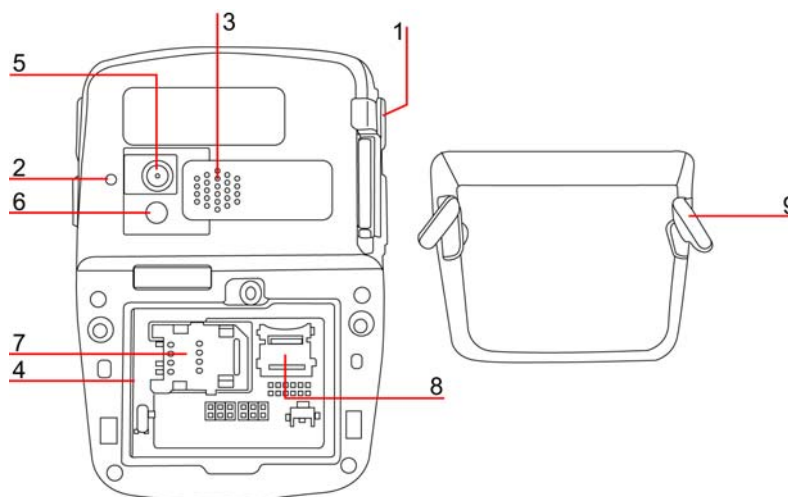

No.	Name	Description
1	Stylus	Tapping on the LCD for selection
2	Reset button	Restarting the terminal
3	Speaker	Audio output
4	Battery compartment	Loading a rechargeable battery (7.4 V, 1850mah)
5	Digital camera	Taking photographs
6	LED Flash light	Serving for camera illuminance
7	SIM card slot	Loading a SIM card
8	Memory card slot	Loading a MicroSD card
9	Battery compartment tab	Helping open the battery cover

Right View

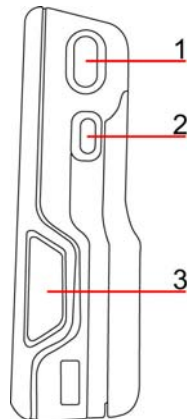

No.	Name	Description
1	Scan trigger button	Barcode scanning control
2	Mute botton	Disabling audio output
3	Earphone jack	A jack for earphones available in a noisy condition

Left View

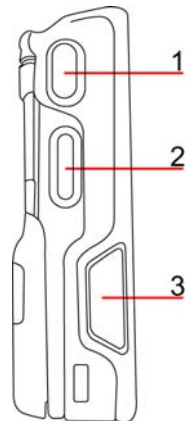

No.	Name	Description
1	Scan trigger button	Barcode scanning control
2	Volume botton	Adjusting the volume
3	Power jack	Connecting an adaptor for PA550 battery charging

Setting up the PA550

This section explains how to install and charge the battery, how to check battery status, how to turn on the terminal, and how to calibrate the screen.

Installing the Battery

WARNING! There is a risk of fire and burns if the battery pack is handled improperly. DO NOT disassemble, crush, puncture, short external contacts, or dispose the battery pack in fire or water. DO NOT attempt to open or service the battery pack. Dispose of used batteries according to local recycling guidelines in your area.

A backup battery cell is embedded into your device to prevent data loss when the removable battery pack is removed or completely discharged. This backup battery will keep the data and system setting for up to 8 hour if the main battery is removed.

NOTE: To enable the internal battery cell to provide backup power supply, charge your device with the main battery pack for at least 16 hours.

NOTE: To power on the device properly, make sure replacing the battery compartment cover after installing the battery.

1. Open the battery compartment cover by sliding the tabs on both sides in the direction of the arrows shown and lift the cover up.

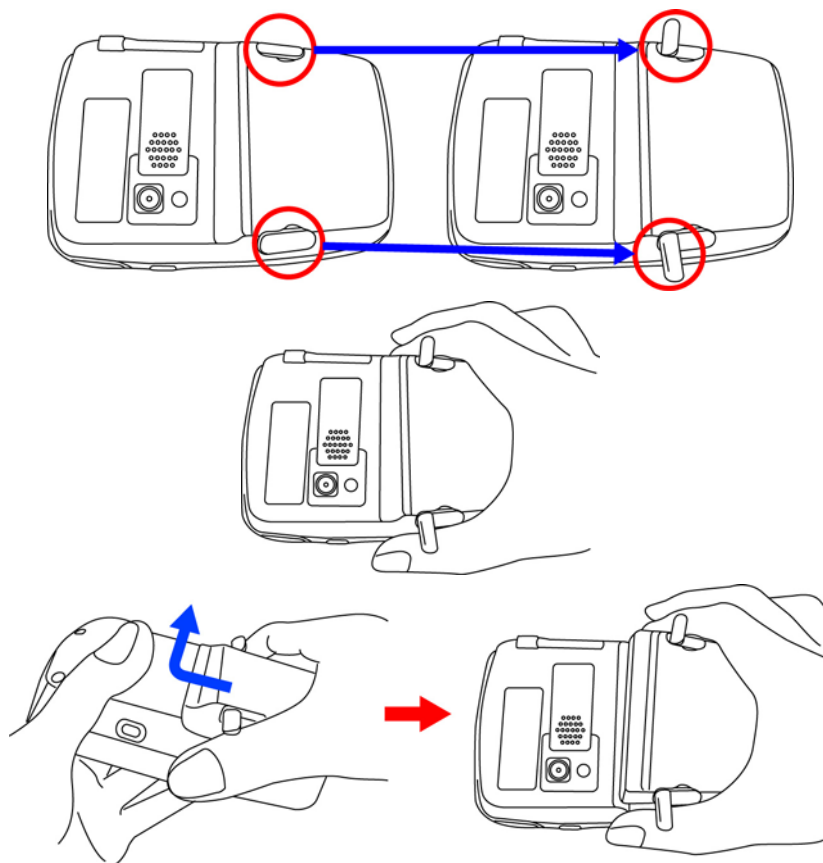

2. Push downwards the backup battery switch to enable the backup battery.

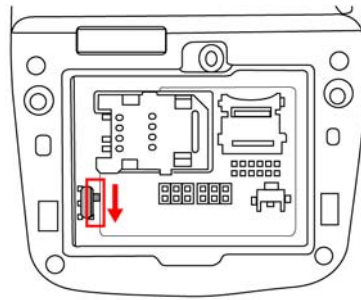

3. Position the battery pack, making sure the battery contacts are aligned with the contacts in the compartment.

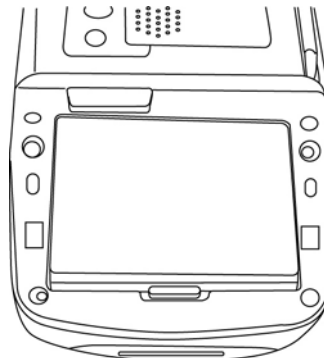
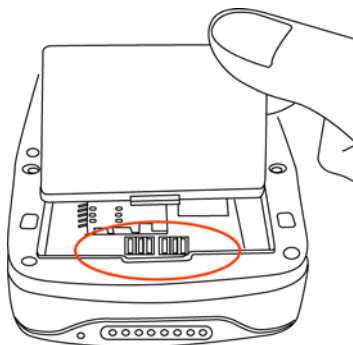

4. Align each tenon on the battery cover with each mortise on the bottom case and wedge them into each other, as shown below.

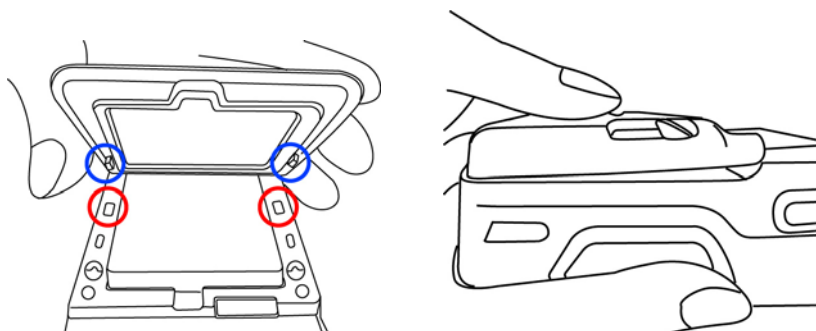
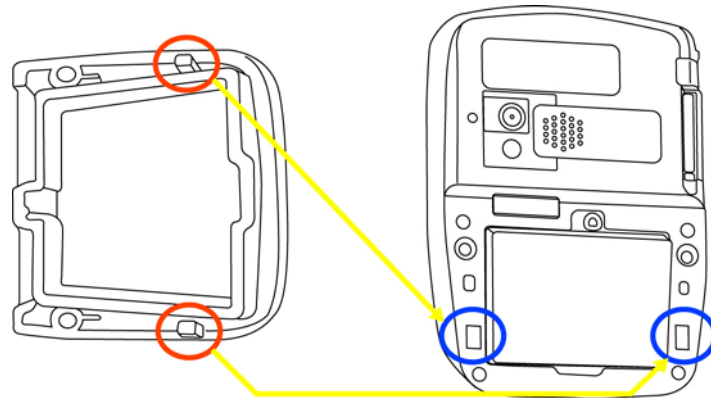

5. Hold a portion where the tenons are located with one hand, while press a portion where a yellow arrow points with the other hand.

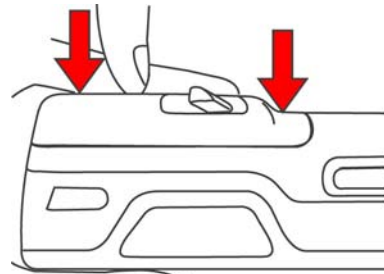

6. Finally, push the tabs inwards to fix the battery cover.

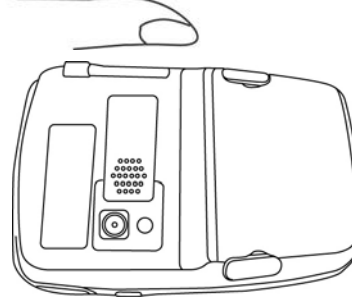

Charging the Battery

Before using the terminal for the first time, you need to charge it for about 16 hours. After that, you can charge the terminal for 4 hours to recharge the battery to full capacity. Charge the terminal using the USB charging cable or the docking station.

CAUTION! Operating the terminal for the first time without the AC adapter, and without fully charging the backup battery may result in loss of data stored in RAM memory. When the main battery is removed, the backup battery retains RAM data in memory for 8 hours. Please charge the battery for the period to avoid data loss in RAM memory.

NOTE: Turn the backup battery switch on before charging the battery. Data you entered may not be properly stored until the built-in backup battery has been fully charged.

Charging the battery with USB charging cable

1. Connect the USB charging cable to PA550 (1).
2. Plug the AC adapter cable into the power jack of the USB charging cable (2).
3. Plug the AC adapter cord into an electrical outlet (3).

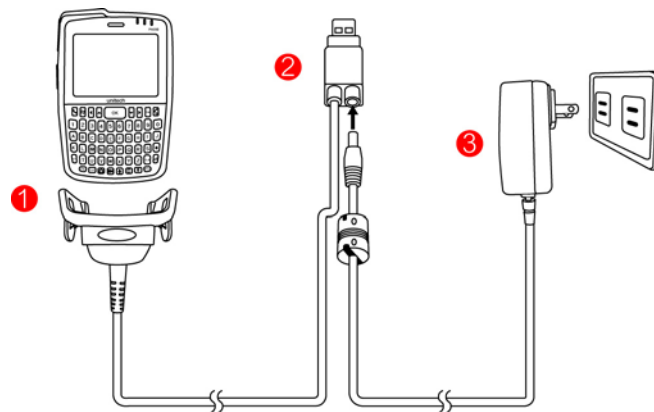

Checking the Battery Status

If the battery level becomes low in the course of normal use, a status icon appears on the device screen indicating low or very low battery status. In both cases, perform an ActiveSync operation to back up your data, and then recharge your device as soon as possible.

CAUTION! Once the device is shut down, you should recharge the device within 48 hours. Otherwise you will lose all data including files stored in the RAM memory.

Connecting the terminal to a host (PC/ Notebook)

Use the USB charging cable to connect the PA550 to a PC/ Notebook in order to use with Activesync.

NOTE: To avoid low battery situation while synchronizing, you should connect the power supply.

1. Press and hold the release button on both sides of the USB charging cable and connect it to PA550.
2. Connect the USB charging cable to the USB port on a PC/ Notebook and plug the AC adapter cable into the power jack of the USB charging cable
3. Plug the AC adapter cord into an electrical outlet.

Turning the terminal on for the first time

After you have initially charged your device for about 16 hours, the device is ready to work. You can now start up your device, calibrate the display, learn some basic stylus usage, and set up the system time zone, date and time.

Power ON Button 

Turn on your device by pressing the power button on the front panel.

Calibrating the screen

To calibrate the screen at any time, follow these instructions.

1. Tap Start  → Settings → System
→ Screen.



2. Tap the Screen icon.
The Screen window appears.

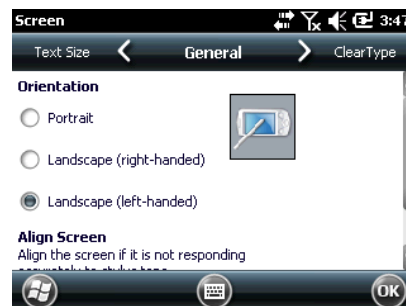

3. Tap Align Screen to calibrate the screen.
The alignment screen appears.
NOTE: Or press Func key and ESC key simultaneously to bring up the alignment screen.

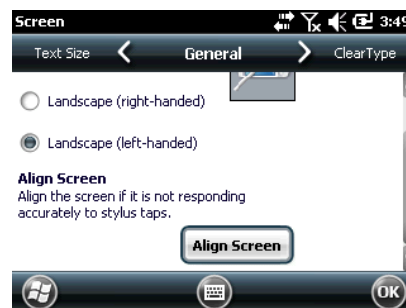

4. Tap the cross hair firmly and accurately.

align screen

Using a stylus, tap the target firmly and accurately at each location on the screen. The target will continue to move until the screen is aligned.



A

align screen

Using a stylus, tap the target firmly and accurately at each location on the screen. The target will continue to move until the screen is aligned.



B

5. Continue tapping the cross hair until the screen has been calibrated.

align screen

Using a stylus, tap the target firmly and accurately at each location on the screen. The target will continue to move until the screen is aligned.



6. When successfully finishing the recalibration, you will be led to exit from the window soon.

Using the Hardware

Using the MicroSD Memory Card

PA550 has an expansion slot for MicroSD card, which are primarily used to backup or transfer files and data.

Inserting a Storage Card

1. Remove the battery cover and the battery.
2. Push down the cover of memory card and then push the cover toward you.

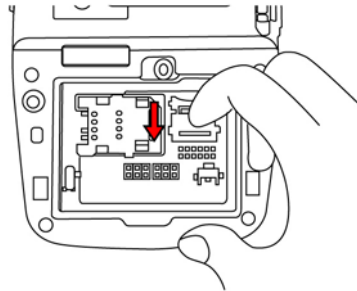

3. Load a MicroSD card in the slot and face up the head of wider area. Push in the card until the card is fully wedged.

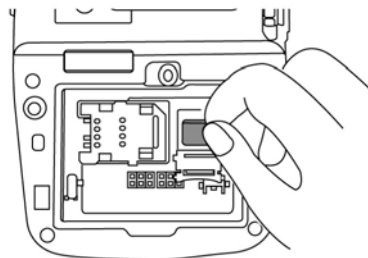

4. Push upwards the memory card tab until the card is fully wedged and secured.

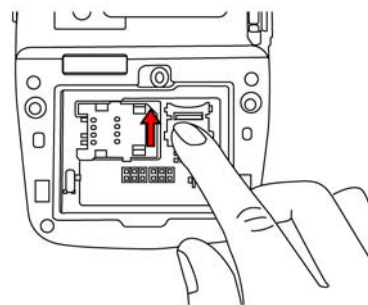

5. Load a battery and get the battery cover on.

Removing the Storage Card

1. Remove the battery cover and the battery.
2. Push downwards the memory card tab until the card is released.
3. Remove the card from the slot.

Using the SIM Card

The PA550 has a slot for GPRS SIM card inside the battery compartment.

CAUTION! Before installing the SIM card, please backup your data to prevent data loss because of a low backup battery.

Inserting the SIM card

1. Remove the battery compartment cover and the main battery.
2. Slide the cover of the SIM card slot to the left to release the latch.

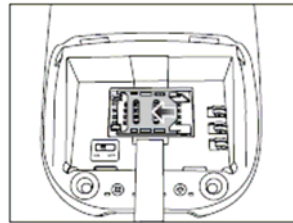

3. Lift the cover and insert the SIM card into the cover with notched corner up, contacts down as shown.

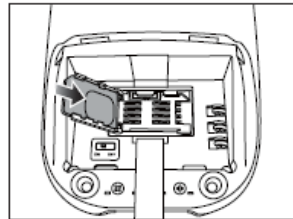

4. Put down the cover on the slot, and then slide the cover to the right to lock the SIM card.

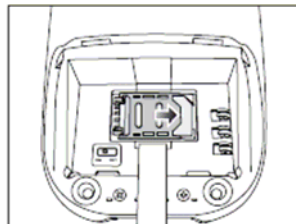

5. Put the battery back into the battery compartment and replace the battery compartment cover.

Using the Barcode Laser Scanner

PA550 has an integrated laser scanner that reads all major barcode labels with excellent performance.

NOTE: The reading software must be enabled in order to operate the scanner. This can be a user-loaded application or a pre-loaded utility such as Scanner.

To launch the Scanner Control Panel, follow these instructions.

1. Tap Start → Settings → System
2. Tap the Scanner icon. The Scanner Control Panel appears.

NOTE: Or press Func key and “7” button simultaneously to bring up the Scanner Control Panel screen.

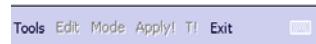
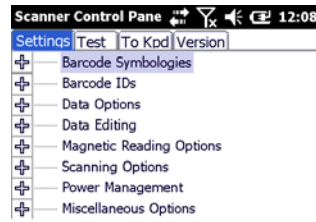

In the Scanner Control Panel screen, you can configure barcode scanner parameters such as enabling or disabling barcode symbologies, setting data transmission options, configuring magnetic and proximity reading options, and setting power management options. See the section of *Barcode Symbologies*.

To test the barcode laser scanner, follow these instructions.

1. Tap the Test tab to activate the demo program.
2. Tap Tools → Enable Scan.
Or tap Tools → Auto-Scan → Start Auto-Scan.
Define the scan interval. Tap Start.

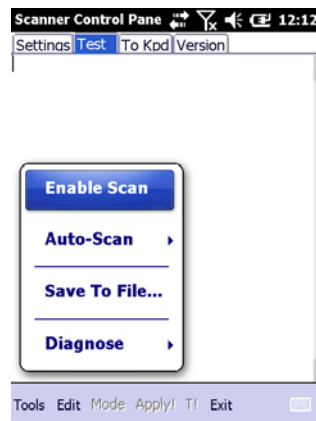

3. Aim the laser scanner at the selected barcode, and press either one of the scanner trigger button on the device.
If you enable Auto-Scan, you don't have to press any button. Aim the laser scanner at the selected barcode while the laser emits light at regular intervals v.
The scanned barcode data appears on the screen.

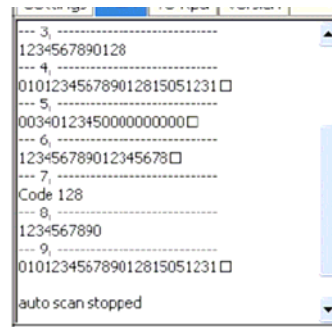

4. Tap Tools → Auto-Scan → Stop Auto-Scan.

Getting Connected

The PA550 enables users to link to a host computer using an RS-232, or Bluetooth, WiFi, and GPRS connection for data communication. This chapter provides an over-view of PA550 communication options.

Establishing Device-PC Connection

Installing Microsoft ActiveSync

In order to exchange data between your computer and the PA550, Microsoft Active-Sync must be installed on your computer. Use the USB/RS232 charging cable that comes with your device or the docking station to connect the device to your computer.

NOTE: If you have a previous version of the Microsoft ActiveSync installed in your computer, uninstall it first before installing the latest version of Microsoft ActiveSync.

To install Microsoft ActiveSync on your computer:

1. Close any open programs, including those that run at startup, and disable any virus-scanning software.
2. Download the ActiveSync software from the Microsoft ActiveSync Download page at <http://www.microsoft.com/downloads/details.aspx?Fami-lyID=7269173a-28bf-4cac-a682-58d3233efb4c&DisplayLang=en>.
3. Browse to the location of the downloaded file, and double-click it. The installation wizard begins.
4. Follow the instructions on the screen to install Microsoft ActiveSync.

Connecting the Device to Your Computer

1. After ActiveSync has been installed, connect PA550 to your PC as described in Connecting the terminal to a host (PC/Notebook) to a PC.
2. Turn ON the PA550.
3. ActiveSync starts automatically and configure the USB port to work with the PA550. The New Partnership setup wizard automatically starts.

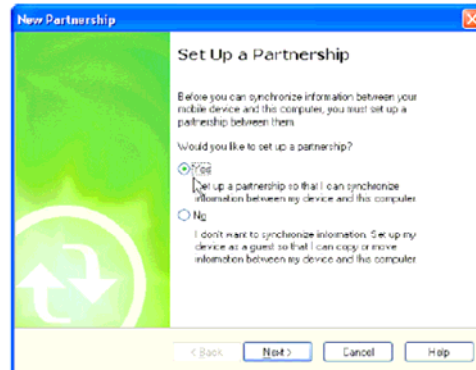

NOTE: If ActiveSync doesn't start automatically, click Start → Programs → Microsoft ActiveSync.

If a message appears indicating that it is unable to detect a connection, click the Cancel button and manually configure the communication settings.

4. Follow the on-screen instructions.
5. When the configuration process is complete, the Active-Sync window appears.

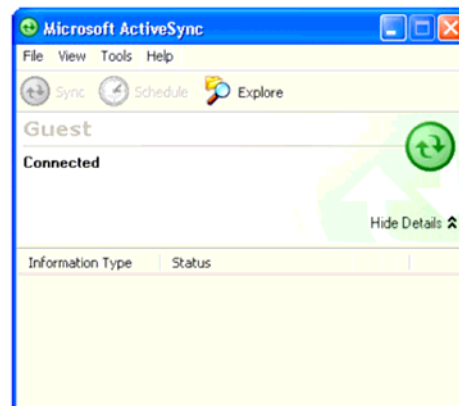

6. Synchronization will be initialized and will take place if you've chosen to synchronize periodically or upon connection.

NOTE: Your computer can create a partnership with multiple PA550s. Also, a PA550 can create a partnership with up to two computers.

Barcode Scanner Programs

The PA550 is provided with a barcode scanner, allowing you to scan and decode 1D barcode.

Scanner Setting

When it is necessary for the user to change the default barcode symbology for a different application, the Scanner Control Panel provides the ability to change default symbology, place delimiter characters behind scanned data, and save the settings.

Tap Start → Settings → System → Scanner.

The Scanner Control Panel appears.

NOTE: Press Func key and “7” button.

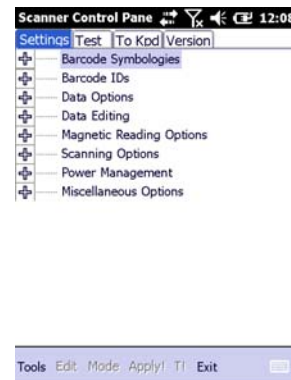

Scan2Key

The Scan2Key application routes input from a scanner port to a keypad buffer, making all input from the scanner emulate input from the keypad. Using Scan2Key, scanned data will be directed from the scanner port to any waiting (active/focused) text editor such as MS Mobile Word or a text box in an application.

Barcode Symbologies

Barcode Symbology	Enable / Disable	Char Check / Digit verification	Transmit Check Char/digit	Others
Australian Post	YES			Send bar width data
British Post	YES			
Canadian Post	YES			
Codabar	YES	YES	YES	Transmit start & stop char, *data length
Code 11	YES	YES		*data length
Code 128/EAN 128	YES			*data length
Code 39	YES	YES	YES	For ASCII, Transmit start & stop char, Append mode, *data length
Code 93	YES			*data length
Dutch (KIX) Post	YES			
EAN 13	YES		YES	2 digit addenda, 5 digit addenda, Addenda required, Include addenda separator
EAN 8	YES		YES	2 digit addenda, 5 digit addenda, Addenda required, Include addenda separator
IATA 2 of 5	YES			*data length
Interleaved 2 of 5	YES	YES	YES	*data length
ISBT	YES			
Japanese Post	YES			
Korean Post	YES			*data length
Matrix 2 of 5	YES			*data length
MSI	YES		YES	*data length
Planet	YES		YES	
Postnet	YES		YES	
RSS	YES			*data length

Barcode Symbology	Enable / Disable	Char Check / Digit verification	Transmit Check Char/digit	Others
(Databar)				
UPC A	YES		YES	2 digit addenda, 5 digit addenda, Addenda required, Include addenda separator, Send number system
UPC E	YES		YES	2 digit addenda, 5 digit addenda, Addenda required, Include addenda separator, Send number system, Expanded UPC-E
UPC E1	YES		YES	2 digit addenda, 5 digit addenda, Addenda required, Include addenda separator, Send number system, Expanded UPC-E

NOTE: *Value Adjustable Scanner Control Panel Version 5.14

Advanced Settings

Performing a Hardware Reset

You may have to perform a reset if the device freezes (i.e., the device no longer responds to the buttons or tapping on the screen).

A soft reset allows your device to get a fresh start, similar to rebooting a computer.

This will restart your device and adjust memory allocation. All records and entries are retained after a soft reset. Unsaved data in open programs may be lost.

Performing a Warm Boot

1. Remove the stylus from its holder.
2. Lightly press the tip of the stylus to the reset button located at the rear side of the terminal, the reset button being located near the camera lens.

Performing a Cold Boot

A cold boot will erase all data and all programs you have added, and will restore the device to the default factory settings.

Never perform a cold boot unless a warm boot does not correct your problem. When you perform your next ActiveSync operation, you can restore any data that you previously synchronized to your computer or you can restore data that you backed up to a storage card.

Method 1: From Windows Mobile

1. Tap Start → BootMode.
The BootMode Screen appears.

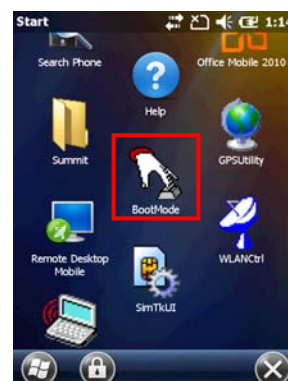

2. Tap Cold Boot.

The system is reset and you will lose all data including all files in the RAM memory.



Method 2: From Hardware

1. Remove the battery compartment cover and the main battery. See the section of *Installing the Battery*.
2. Turn the backup battery switch off.

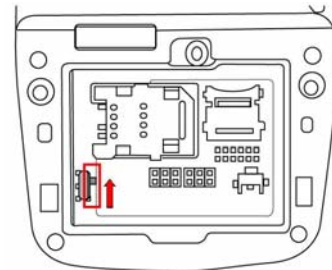

3. Turn the backup battery switch on.
4. Put the battery back into the battery compartment and re-place the battery compartment cover.
System will cold boot.

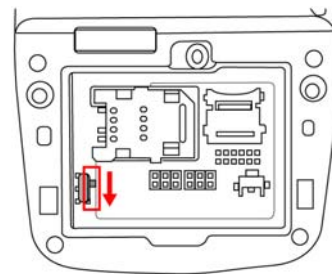

NOTE: When you perform hard reset, the data and time settings will not be retained. Formats, preferences, and other settings are restored to their default factory settings.

System Specification

CPU	Intel PXA320, 806MHz	
Memory	Mobile DDR: 256MB NaNDFlash: 512MB	
OS	Windows Mobile 6.5.3 Professional/Classic	
Keypad	QWERTY keys (with LED backlight) Numeric key (to be available)	
Display	2.8" 240x320 (QVGA), color transfective TFT, with touch screen & backlight	
Indicator	LEDs, Vibrator	
Barcode Scanner	1D Laser scanner	
Symbologies	1D barcode engine	
Camera	5.0M-pixel camera with flash light	
Audio	MIC, speaker, headset connector, receiver	
Address Locating	GPS	
Expansion Slot	MicroSD supporting SDHC	
Power Source	Main battery	9.25 watts (3.7V 2500mAH) Li-ion battery pack
	Backup battery	One rechargeable Ni-MH backup battery
	Operation Hours	Up to 10 hrs., depending on configuration and application
Communication	USB	1.1 Host & Client
	WLAN	IEEE 802.11b/g
	PAN	Bluetooth 2.1 + EDR

	WWAN	3.5G Five-bands, GSM/GPRS 850Mhz, 900MhZ, 1800Mhz and 1900Mhz,UMTS WCDMA/HSDPA 50Mhz, 1900Mhz ,2100Mhz / GPRS Edge
	GPS	UBlox NEO-5Q
Enclosure	Weight	320g with battery
	Dimension	Approximately 125mm x 82mm x 35mm (Antenna length excluded)
Environmental	Operating temperature	14°F to 122°F (-10 °C ~ 50 °C)
	Storage temperature	-4°F to 140°F (-20 °C ~ 60 °C)
	Relative humidity	5% ~ 95% (non-condensing)
	Drop test to concrete	1.2 meter (4 feet)
	Environmental sealing	IP54
Regulatory Approvals	CE, FCC, BSMI, VCCI, CCC, RoHS Compliance	
Software	Microsoft Visual Studio 2005/2008 Oracle Database Lite Mobile SIP (VOIP) Auto Installer	
Accessories	Desktop USB Cradle Desktop Ethernet Cradle USB communication and charging cable AC adaptor (with regional power cord)	

Appendix II

Worldwide Support

Unitech's professional support team is available to quickly answer questions or technical-related issues. Should an equipment problem occur, please contact the nearest Unitech regional service representative. For complete contact information please visit the Web sites listed below:

Region	Web Site
Global Operation Center	http://www.ute.com
Unitech Taiwan	http://tw.ute.com
Unitech Asia Pacific & Middle East	http://apac.ute.com ; http://india.ute.com
Greater China Division	http://cn.ute.com
Unitech Japan	http://jp.ute.com
Unitech America	http://us.ute.com ; http://can.ute.com
Unitech Latin America	http://latin.ute.com
Unitech Europe	http://eu.ute.com