



MC92N0-G



Mobile Computer

User Guide



MC92N0-G
User Guide

72E-162536-06

Rev A

December 2016

No part of this publication may be reproduced or used in any form, or by any electrical or mechanical means, without permission in writing from Zebra. This includes electronic or mechanical means, such as photocopying, recording, or information storage and retrieval systems. The material in this manual is subject to change without notice.

The software is provided strictly on an “as is” basis. All software, including firmware, furnished to the user is on a licensed basis. Zebra grants to the user a non-transferable and non-exclusive license to use each software or firmware program delivered hereunder (licensed program). Except as noted below, such license may not be assigned, sublicensed, or otherwise transferred by the user without prior written consent of Zebra. No right to copy a licensed program in whole or in part is granted, except as permitted under copyright law. The user shall not modify, merge, or incorporate any form or portion of a licensed program with other program material, create a derivative work from a licensed program, or use a licensed program in a network without written permission from Zebra. The user agrees to maintain Zebra’s copyright notice on the licensed programs delivered hereunder, and to include the same on any authorized copies it makes, in whole or in part. The user agrees not to decompile, disassemble, decode, or reverse engineer any licensed program delivered to the user or any portion thereof.

Zebra reserves the right to make changes to any software or product to improve reliability, function, or design.

Zebra does not assume any product liability arising out of, or in connection with, the application or use of any product, circuit, or application described herein.

No license is granted, either expressly or by implication, estoppel, or otherwise under any Zebra Technologies Corporation, intellectual property rights. An implied license only exists for equipment, circuits, and subsystems contained in Zebra products.

Revision History

Changes to the original manual are listed below:

Change	Date	Description
-01 Rev. A	12/2012	Initial Release.
-02 Rev. A	05/31/13	Add Windows Embedded Handheld support.
-03 Rev. A	12/01/14	Zebra Rebranding
-04 Rev. A	6/2015	Add new Standard Range and Mid-Range imagers.
-05 Rev. A	8/2015	Add support for Android™ OS.
-06 Rev. A	11/2016	Add support for SE4850 Extended Range Imager. Remove obsolete accessories.

TABLE OF CONTENTS

Revision History	iii
------------------------	-----

About This Guide

Introduction	xiii
Documentation Set.....	xiii
Configurations.....	xiv
Software Versions.....	xv
Windows Mobile and Windows CE	xv
Android.....	xvi
Chapter Descriptions	xvi
Notational Conventions.....	xvi
Related Documents and Software	xvii
Service Information	xvii

Chapter 1: Getting Started

Introduction	1-1
Unpacking	1-2
Getting Started	1-2
Installing the Main Battery	1-2
Charging the Battery	1-3
Charging the Main Battery and Memory Backup Battery	1-3
Charging Spare Batteries	1-4
Removing the Main Battery	1-5
Starting the MC92N0-G	1-6
Calibrating the Screen	1-6
Windows Devices	1-6
Android Devices	1-6
Checking Battery Status	1-6
MC92N0-G Strap	1-7
Battery Management	1-7
Battery Saving Tips	1-7
Changing the Power Settings	1-7
Changing the Display Backlight Settings	1-8

Changing the Display Brightness	1-8
Changing the Keypad Backlight Settings	1-8
Windows Devices	1-8
Android Devices	1-9
Turning Off the Radios	1-9
On Windows Embedded Handheld Devices	1-9
On Windows CE Devices	1-9
WLAN Radio	1-9
Bluetooth Radio with StoneStreet One Stack Enabled	1-10
On Android Devices	1-10
LED Indicators	1-11
Keypads	1-11
Entering Data	1-11
Using a Wired Headset	1-12
Using a Bluetooth Headset	1-13

Chapter 2: Operating the MC92N0-G with Windows OS

Introduction	2-1
Windows CE 7.0	2-1
Start Menu	2-2
Control Panel	2-4
Windows Embedded Handheld	2-5
Finger Scrolling	2-5
Home Screen	2-5
Classic Today Screen	2-7
Status Bar	2-8
Tile Bar	2-10
Start Screen	2-10
Speaker Icon	2-14
Locking the MC92N0-G	2-14
Locking without PIN or Password	2-14
Locking with Simple PIN	2-15
Locking with Strong Password	2-15
Password Locking Setup	2-16
Using the Power Button	2-17
Wireless LAN	2-17
Windows CE Devices	2-17
Windows Embedded Handheld Devices	2-18
Connecting to the Internet	2-19
Supported Applications	2-19
Fusion Setup	2-20
Interactive Sensor Technology	2-23
Power Management	2-23
Display Orientation	2-23
Free Fall Detection	2-23
Using a Wired Headset	2-23
Using a Bluetooth Headset	2-24
Resetting the MC92N0-G	2-24
Windows CE Devices	2-24

Performing a Warm Boot	2-24
Performing a Cold Boot	2-24
Windows Embedded Handheld Devices	2-25
Performing a Warm Boot	2-25
Performing a Cold Boot	2-25
Battery Health	2-26
Waking the MC92N0-G	2-26

Chapter 3: Operating the MC92N0-G with Android OS

Introduction	3-1
Home Screen	3-1
Status Bar	3-2
Status Icons	3-2
Notification Icons	3-3
Managing Notifications	3-4
Quick Settings	3-5
Application Shortcuts and Widgets	3-6
Adding an Application or Widget to the Home Screen	3-6
Moving Items on the Home Screen	3-6
Removing an App or Widget from the Home Screen	3-7
Folders	3-7
Creating a Folder	3-7
Naming Folders	3-7
Removing a Folder	3-7
Home Screen Wallpaper	3-8
Changing the Home Screen Wallpaper	3-8
Using the Touchscreen	3-8
Using the On-screen Keyboard	3-8
Editing Text	3-9
Entering Numbers, Symbols and Special Characters	3-9
Applications	3-9
Accessing Applications	3-11
Switching Between Recent Applications	3-12
Un-Locking the Screen	3-12
Single User Mode	3-12
MultiUser Mode	3-14
MultiUser Login	3-14
MultiUser Logout	3-14
Resetting the Android Device	3-15
Performing a Soft Reset	3-15
Performing a Hard Reset	3-15
Suspend Mode	3-15
Applications	3-16
File Browser	3-16
People	3-17
Adding People	3-17
Editing People	3-17
Deleting People	3-18
Gallery	3-18

Working with Albums	3-19
Share an Album	3-19
Get Album Information	3-19
Deleting an Album	3-19
Working with Photos	3-20
Viewing and Browsing Photos	3-20
Setting a Photo as a Contact Icon	3-21
Share a Photo	3-21
Deleting a Photo	3-21
Working with Videos	3-22
Watching Videos	3-22
Sharing a Video	3-23
Deleting a Video	3-23
DataWedge Demonstration	3-23
Sound Recorder	3-24
PTT Express Voice Client	3-25
PTT Audible Indicators	3-25
Notification Icons	3-26
Selecting a Talk Group	3-27
PTT Communication	3-27
Creating a Group Call	3-27
Creating a Private Call (One to One)	3-27
Disabling PTT Express Voice Client Communication	3-28
MLog Manager	3-28
RxLogger	3-28
Elemesz	3-29
Disabling Elemesz Data Collection	3-29
Enabling Elemesz Data Collection	3-30
Terminal Emulation	3-30
Velocity	3-31
Wireless Local Area Networks	3-31
Scan and Connect to a Wi-Fi Network	3-32
Configuring a Wi-Fi Network	3-32
Manually Adding a Wi-Fi Network	3-34
Configuring for a Proxy Server	3-35
Configuring the Device to Use a Static IP Address	3-36
Advanced Wi-Fi Settings	3-36
Remove a Wi-Fi Network	3-38

Chapter 4: Data Capture

Scan LED Indicators	4-1
Laser Scanning	4-1
Scanning Considerations	4-2
Imaging	4-3
Operational Modes	4-3
Imager Scanning	4-3
Image Capture	4-6
DataWedge	4-7
Enable DataWedge	4-7

Disable DataWedge	4-7
ScanSample	4-8
Using the RS507 Hands-free Imager	4-8
Pairing the RS507 Hands-Free Imager using Android HID	4-8
Pairing the RS507 Hands-Free Imager Using Android SSI	4-9

Chapter 5: Using Bluetooth on Windows Devices

Introduction	5-1
Adaptive Frequency Hopping	5-1
Security	5-2
Security Mode 3 (Link Level Encryption)	5-2
Microsoft Bluetooth Stack	5-2
StoneStreet One Bluetooth Stack	5-2
Bluetooth Configuration	5-3
Bluetooth Power States	5-4
Suspend	5-4
Resume	5-4
BTUI Window	5-5
Device Information	5-5
FIPS Configuration	5-5
Device Status	5-6
Using Microsoft Bluetooth Stack with Windows Embedded Handheld	5-7
Turning the Bluetooth Radio Mode On and Off	5-7
Enabling Bluetooth	5-7
Disabling Bluetooth	5-7
Discovering Bluetooth Device(s)	5-7
Available Services	5-8
Object Push Services via Beam	5-8
Serial Port Services	5-9
ActiveSync Using Serial Port Services	5-10
Using Microsoft Bluetooth Stack with Windows CE	5-12
Power Modes	5-12
Discovering Bluetooth Device(s)	5-12
Available Services	5-13
Using Bluetooth StoneStreet One Bluetooth Stack	5-14
Turning the Bluetooth Radio Mode On and Off	5-14
Disabling Bluetooth (Windows CE)	5-14
Enabling Bluetooth (Windows CE)	5-14
Disabling Bluetooth (Windows Embedded Handheld)	5-14
Enabling Bluetooth (Windows Embedded Handheld)	5-14
Modes	5-15
Wizard Mode	5-15
Explorer Mode	5-15
Discovering Bluetooth Device(s)	5-15
Available Services	5-18
File Transfer Services	5-18
Connecting to the Internet Using an Access Point	5-20
Dial-Up Networking Services	5-20
Add a Dial-up Entry	5-22

Object Exchange Push Services	5-23
Headset Services	5-26
Serial Port Services	5-27
ActiveSync Using Serial Port Services	5-27
Personal Area Network Services	5-28
A2DP/AVRCP Services	5-28
Connect to a HID Device	5-29
Pairing with Discovered Device(s)	5-29
Bluetooth Settings	5-31
Device Info Tab	5-31
Services Tab	5-31
Security Tab	5-34
Discovery Tab	5-35
Virtual COM Port Tab	5-35
HID Tab	5-35
Profiles Tab	5-36
System Parameters Tab	5-36
Miscellaneous Tab	5-36

Chapter 6: Using Bluetooth on Android Devices

Introduction	6-1
Adaptive Frequency Hopping	6-1
Security	6-2
Bluetooth Profiles	6-2
Bluetooth Power States	6-2
Bluetooth Radio Power	6-3
Enabling Bluetooth	6-3
Disabling Bluetooth	6-3
Discovering Bluetooth Device(s)	6-3
Changing the Bluetooth Name	6-4
Connecting to a Bluetooth Device	6-5
Selecting Profiles on the Bluetooth Device	6-5
Unpairing a Bluetooth Device	6-5

Chapter 7: Accessories

Introduction	7-1
Secure Device (SD) Card	7-5
Single Slot Serial/USB Cradle	7-6
Four Slot Ethernet Cradle	7-8
Four Slot Charge Only Cradle	7-9
Four Slot Spare Battery Charger	7-10
Cable Adapter Module	7-11
Attaching and Removing	7-11
Setup	7-12
Battery Charging Indicators	7-13
Serial/USB Connection	7-13
Universal Battery Charger (UBC) Adapter	7-14
Inserting and Removing a Battery	7-14

Battery Charging Indicators	7-14
Forklift Cradle	7-16
MC92N0-G Insertion and Removal	7-17
Using the Locking Mechanism	7-18
Connecting External Devices	7-18
Supported Scanners	7-19

Chapter 8: Maintenance & Troubleshooting

Introduction	8-1
Maintaining the MC92N0-G	8-1
Battery Safety Guidelines	8-1
Cleaning	8-2
Approved Cleanser Active Ingredients	8-2
Harmful Ingredients	8-2
Cleaning Instructions	8-3
Special Cleaning Notes	8-3
Materials Required	8-3
Cleaning the MC92N0-G	8-3
Housing	8-3
Display	8-3
Scanner Exit Window	8-3
Battery Contacts	8-3
Cleaning Cradle Connectors	8-4
Cleaning Frequency	8-4
Troubleshooting	8-5
MC92N0-G	8-5
Four Slot Spare Battery Charger	8-8
Single Slot Serial/USB Cradle	8-8
Cable Adapter Module	8-9
Magnetic Stripe Reader	8-10

Appendix A: Specifications

Technical Specifications	A-1
MC92N0-G	A-1

Appendix B: Keypads

Introduction	B-1
28-Key Keypad	B-2
43-Key Keypad	B-6
53-Key Keypad	B-10
3270 Emulator Keypad	B-14
5250 Emulator Keypad	B-18
VT Emulator Keypad	B-22
Keypad Special Functions	B-26
Special Characters	B-27

ABOUT THIS GUIDE

Introduction

This guide provides information about using the MC92N0-G mobile computer and accessories.

✓ **NOTE** Screens and windows pictured in this guide are samples and can differ from actual screens.

Documentation Set

The documentation set for the MC92N0-G is divided into guides that provide information for specific user needs.

- **MC92N0-G Quick Start Guide** - describes how to get the MC92N0-G mobile computer up and running.
- **MC92N0-G User Guide** - describes how to use the MC92N0-G mobile computer.
- **MC92N0-G Integrator Guide** - describes how to set up the MC92N0-G mobile computer and the accessories.
- **MC92N0-G Regulatory Guide** - provides all regulatory, service and EULA information for the MC92N0-G mobile computer.
- **Enterprise Mobility Developer Kit (EMDK) Help File** - provides API information for writing applications.

Configurations

This guide covers the following configurations:

Feature	MC9200 Premium with Android	MC9200 Premium with Windows	MC9200 Standard Windows
CPU			
TI OMAP 4430 1GHz	X	X	X
Radios			
WLAN: 802.11 a/b/g/n	X	X	X
Memory			
1 GB RAM / 2 GB Flash	X	X	
512 MB RAM / 2 GB Flash			X
Operating System			
Android 4.4	X		
Microsoft Windows Embedded Handheld 6.5.3		X	
Microsoft Windows Embedded Compact 7		X	X
Display			
3.7" VGA color	X	X	
3.7" QVGA color			X
Data Capture			
SE4750-SR Standard Range Imager	X	X	
SE4750-MR Mid-Range Imager	X	X	
SE-965 Standard Range Laser	X	X	X
SE4500-DL Driver License Imager		X	
SE4500-SR Standard Range Imager	X	X	X
SE4500-HD High Density Imager (DPM)		X	
SE1524-ER Extended Range Laser	X	X	X
SE4600-LR Long Range Imager		X	X
SE4850-ER Extended Range Imager	X	X	X
Keypads			
53, 53 VT, 5250, 3270, 28, 43	X	X	X
53 key High Visibility	X	X	
Audio			
2 Watt Speaker	X	X	X
Miscellaneous			
IST, RFID tag	X	X	
Condensation Resistant Option	X	X	

Feature	MC9200 Premium with Android	MC9200 Premium with Windows	MC9200 Standard Windows
Software			
Wavelink Terminal Emulation Green Screen (Default U/I)	Pre-loaded / pre-licensed	CE: Pre-loaded / pre-licensed WM: Pre-licensed	CE: Pre-loaded / pre-licensed WM: Pre-licensed
Wavelink All-Touch Terminal Emulation	Pre-loaded / demo mode		

Software Versions

Windows Mobile and Windows CE

This guide covers various software configurations and references are made to operating system or software versions for:

- AKU version
- OEM version
- BTEplorer version
- Fusion version.

AKU Version for Windows Embedded Handheld Devices

To determine the Adaptation Kit Update (AKU) version on a Windows Embedded Handheld device, tap **Start > Settings > System > About > Version**.

The second line lists the operating system version and the build number. The last part of the build number represents the AKU number. For example, *Build 23103.5.3.3* indicates that the device is running AKU version 5.3.3.

OEM Version

To determine the OEM software version:

On Windows Embedded Handheld devices, tap **Start > Settings > System > System Information > System**.

On Windows CE devices, tap **Start > Settings > Control Panel > System Information > System**.

BTEplorer Software

- ✓ **NOTE** By default, the Microsoft Bluetooth stack is enabled. BTEplorer application is only available when the StoneStreet One Bluetooth stack is enabled. Refer to the *MC92N0-G Integrator Guide* for information on selecting the Bluetooth stack.

To determine the BTEplorer software version:

On Windows Embedded Handheld devices, tap **Start > BTEplorer > Menu > About**.

On Windows CE devices, tap **BTEplorer icon > Show BTEplorer > File > About**.

Fusion Software

To determine the Fusion software version:

On Windows Embedded Handheld devices, tap **Start > Wireless Companion > Wireless Status > Versions**.

On Windows CE devices, tap **Wireless Strength** icon > **Wireless Status > Versions** or tap **Start > Programs > Fusion > Wireless Status > Versions**.

Android

To determine the current software versions touch  > **About device**.

- **Serial number** - Displays the serial number.
- **Model number** - Displays the model number.
- **Android version** - Displays the operating system version.
- **Kernel version** - Displays the kernel version number.
- **Build number** - Displays the software build number.

Chapter Descriptions

Topics covered in this guide are as follows:

- [Chapter 1, Getting Started](#), provides information on getting the mobile computer up and running for the first time.
- [Chapter 2, Operating the MC92N0-G with Windows OS](#), explains how to use the mobile computer with Windows CE and Windows Mobile operating system. This includes instructions for powering on and resetting the mobile computer, entering and capturing data.
- [Chapter 3, Operating the MC92N0-G with Android OS](#), explains how to use the mobile computer with Android operating system. This includes instructions for powering on and resetting the mobile computer, entering and capturing data.
- [Chapter 4, Data Capture](#), explains how to capture data using the various scanning options.
- [Chapter 5, Using Bluetooth on Windows Devices](#), explains how to perform Bluetooth functionality on the mobile computer with Windows CE and Windows Mobile operating system.
- [Chapter 6, Using Bluetooth on Android Devices](#), explains how to perform Bluetooth functionality on the mobile computer with Android operating system.
- [Chapter 7, Accessories](#), describes the accessories available for the mobile computer and how to use the accessories with the mobile computer.
- [Chapter 8, Maintenance & Troubleshooting](#), includes instructions on cleaning and storing the mobile computer, and provides troubleshooting solutions for potential problems during mobile computer operation.
- [Appendix A, Specifications](#), includes a table listing the technical specifications for the mobile computer.
- [Appendix B, Keypads](#), contains the keypad functions/special characters for the keypads.

Notational Conventions

The following conventions are used in this document:

- “Mobile computer” refers to the Zebra MC92N0-G hand-held computer.

- *Italics* are used to highlight the following:
 - Chapters and sections in this guide
 - Related documents
- **Bold** text is used to highlight the following:
 - Dialog box, window and screen names
 - Drop-down list and list box names
 - Check box and radio button names
 - Icons on a screen
 - Key names on a keypad
 - Button names on a screen.
- Bullets (•) indicate:
 - Action items
 - Lists of alternatives
 - Lists of required steps that are not necessarily sequential.
- Sequential lists (e.g., those that describe step-by-step procedures) appear as numbered lists.

Related Documents and Software

The following documents provide more information about the MC92N0-G mobile computers.

- *MC92N0-G Regulatory Guide*, p/n 72-161752-xx
- *MC92N0-G Integrator Guide*, p/n 72E-162537-xx
- *Enterprise Mobility Developer Kits (EMDKs)*, available at: <http://www.zebra.com/support>.
- Device Configuration Package (DCP for MC92N0c70) and Platform SDK (PSDK92N0c70) for MC92N0-G with Windows CE 7.0, available at: <http://www.zebra.com/support>.
- ActiveSync software, available at: <http://www.microsoft.com>.

For the latest version of this guide and all guides, go to: <http://www.zebra.com/support>.

Service Information

If you have a problem with your equipment, contact Zebra Solutions Global Customer Support for your region. Contact information is available at: <http://www.zebra.com/support>.

When contacting support, please have the following information available:

- Serial number of the unit
- Model number or product name
- Software type and version number.

Zebra responds to calls by email, telephone or fax within the time limits set forth in support agreements.

If your problem cannot be solved by Zebra Support, you may need to return your equipment for servicing and will be given specific directions. Zebra is not responsible for any damages incurred during shipment if the approved shipping container is not used. Shipping the units improperly can possibly void the warranty.

If you purchased your Zebra business product from a Zebra business partner, contact that business partner for support.

CHAPTER 1 GETTING STARTED

Introduction

This chapter explains how to install and charge the batteries, replace the strap and start the MC92N0-G for the first time.

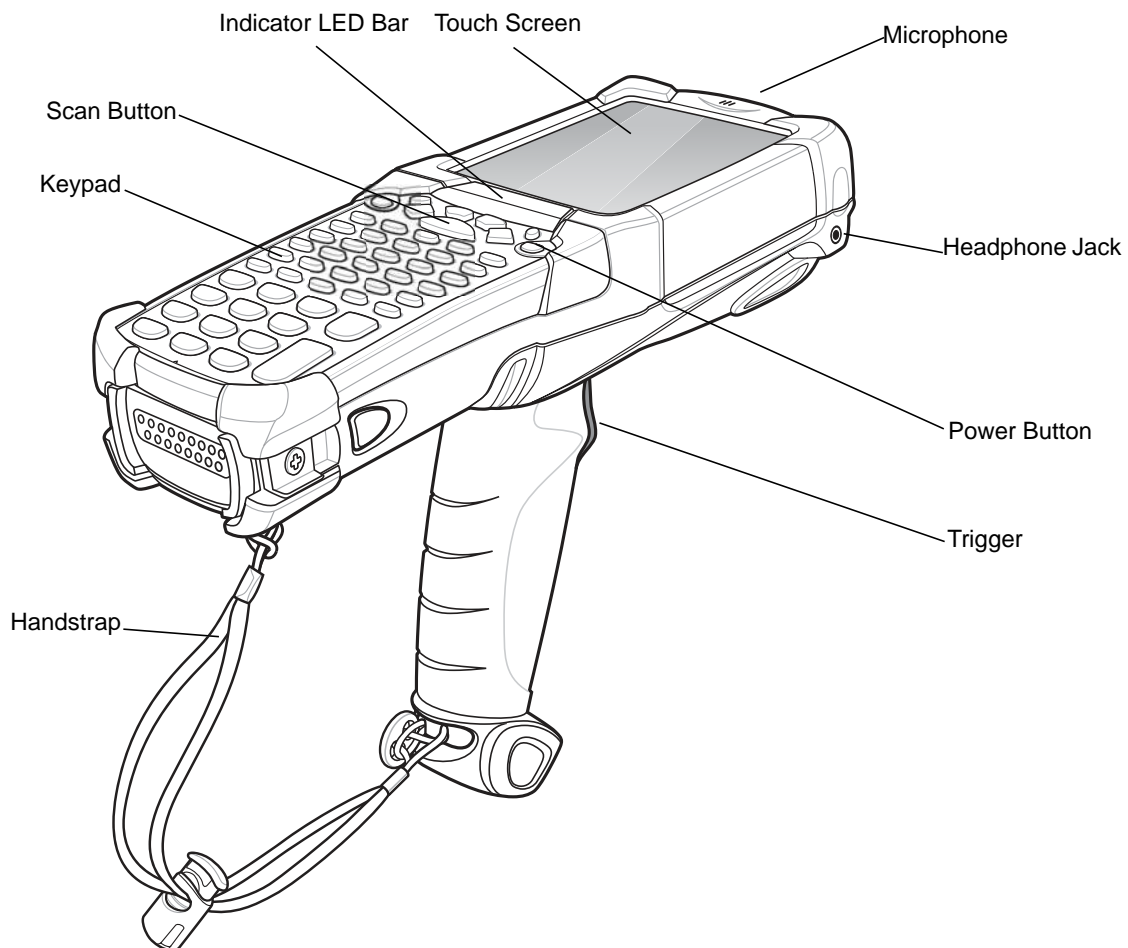

Figure 1-1 MC92N0-G

Unpacking

Carefully remove all protective material from around the MC92N0-G and save the shipping container for later storage and shipping.

Verify that you received all equipment listed below:

- mobile computer
- lithium-ion battery
- strap, attached to the MC92N0-G
- stylus, in the stylus silo
- Regulatory Guide.

Inspect the equipment for damage. If you are missing any equipment or if you find any damaged equipment, contact the Zebra Support Center immediately. See [page xvii](#) for contact information.

Getting Started

In order to start using the MC92N0-G for the first time:

- install the main battery
- charge the main battery and backup battery
- start the MC92N0-G
- configure the MC92N0-G.

The main battery can be charged before or after it is installed. Use one of the spare battery chargers to charge the main battery (out of the MC92N0-G), or one of the cradles to charge the main battery installed in the MC92N0-G.

Installing the Main Battery

Before using the MC92N0-G, install a lithium-ion battery by sliding the battery into the MC92N0-G as shown in [Figure 1-2](#).

- ✓ **NOTE** Ensure the battery is fully inserted. Two audible clicks can be heard as the battery is fully inserted. A partially inserted battery may result in unintentional data loss.

When a battery is fully inserted in a MC92N0-G for the first time, upon first power up, the device boots and powers on automatically.

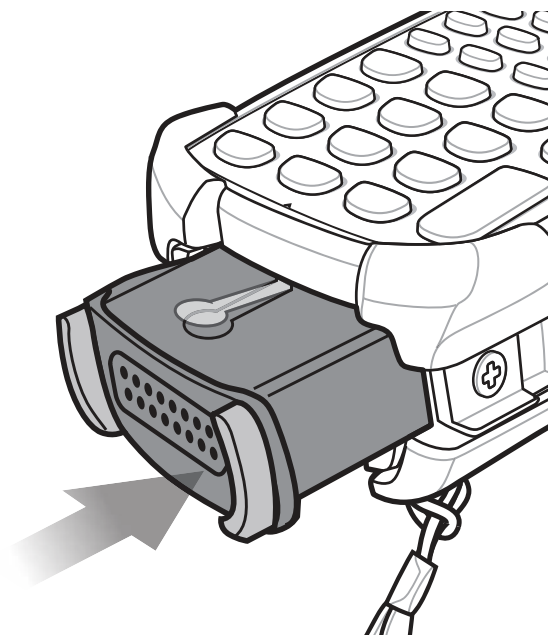

Figure 1-2 Installing the Main Battery

Charging the Battery



CAUTION Ensure that you follow the guidelines for battery safety described in *Battery Safety Guidelines* on page 8-1.

Charging the Main Battery and Memory Backup Battery

Before using the MC92N0-G for the first time, charge the main battery until the amber charge indicator light remains lit (see [Table 1-1 on page 1-4](#) for charge status indications). The main battery fully charges in less than four hours. The MC92N0-G can be charged using a cradle, the CAM, or the MSR with the appropriate power supply.

The MC92N0-G is also equipped with a memory backup battery which automatically charges from the main battery whether or not the MC92N0-G is operating or is in suspend mode. The memory backup battery retains data in memory for at least 30 minutes when the MC92N0-G's main battery is removed or fully discharged. When the MC92N0-G is used for the first time or after the memory backup battery has fully discharged, the memory backup battery requires approximately 15 hours to fully charge. Do not remove the main battery from the MC92N0-G for 15 hours to ensure that the memory backup battery fully charges. If the main battery is removed from the MC92N0-G or the main battery is fully discharged, the memory backup battery completely discharges in several hours.

When the main battery reaches a very low battery state, the combination of main battery and backup battery retains data in memory for at least 72 hours.



NOTE Do not remove the main battery within the first 15 hours of use. If the main battery is removed before the backup battery is fully charged, data may be lost.

Use the following to charge batteries:

- Cradles: The MC92N0-G slips into the cradles for charging the battery in the MC92N0-G (and spare batteries, where applicable). For detailed cradle setup and charging procedures refer to the *MC92N0-G Integrator Guide*.
 - Single Slot Serial/USB Cradle.
 - Four Slot Ethernet Cradle
 - Four Slot Charge Only Cradle.
- Accessories: The MC92N0-G snap-on accessories provide charging capability, when used with one of the accessory charging cables. For detailed snap-on setup and charging procedures refer to the *MC92N0-G Integrator Guide*.
 - CAM
 - MSR.
- Chargers: The MC92N0-G spare battery charging accessories are used to charge batteries that are removed from the MC92N0-G. For detailed spare battery charging accessories setup and charging procedures refer to the *MC92N0-G Integrator Guide*.
 - Single Slot Serial/USB Cradle
 - Four Slot Spare Battery Charger
 - Universal Battery Charger (UBC) Adapter.

✓ **NOTE** To achieve the best battery life in MC92N0-Gs with multiple radios, turn off the radios that are not being used. See *Turning Off the Radios on page 1-9* for more information.

To charge the main battery:

1. Ensure the accessory used to charge the main battery is connected to the appropriate power source.
2. Insert the MC92N0-G into a cradle or attach the appropriate snap-on module.
3. The MC92N0-G starts to charge automatically. The amber charge LED, in the Indicator LED Bar, lights to indicate the charge status. See *Table 1-1* for charging indications.

The main battery usually fully charges in less than four hours.

Table 1-1 MC92N0-G LED Charge Indicators

LED	Indication
Off	MC92N0-G not in cradle or connected to a CAM or MSR. MC92N0-G not placed correctly. Charger is not powered.
Fast Blinking Amber	Error in charging; check placement of the MC92N0-G.
Slow Blinking Amber	MC92N0-G is charging.
Solid Amber	Charging complete. Note: When the battery is initially inserted in the MC92N0-G, the amber LED flashes once if the battery power is low or the battery is not fully inserted.

Charging Spare Batteries

Use the following three accessories to charge spare batteries:

- Single Slot Serial/USB Cradle

- Four Slot Spare Battery Charger
- UBC Adapter.

Refer to [Chapter 7, Accessories](#) for information on charging a spare battery using an accessory.

Removing the Main Battery

To remove the main battery:

1. Prior to removing the battery, press the red **Power** button.
2. Tap **Safe Battery Swap**.
3. The Indicator LED Bar lights red.
4. When the Indicator LED turns off, press the primary battery releases. The battery partially ejects from the MC92N0-G.
5. Press the secondary battery release, on top of the battery, and slide the battery out of the MC92N0-G.

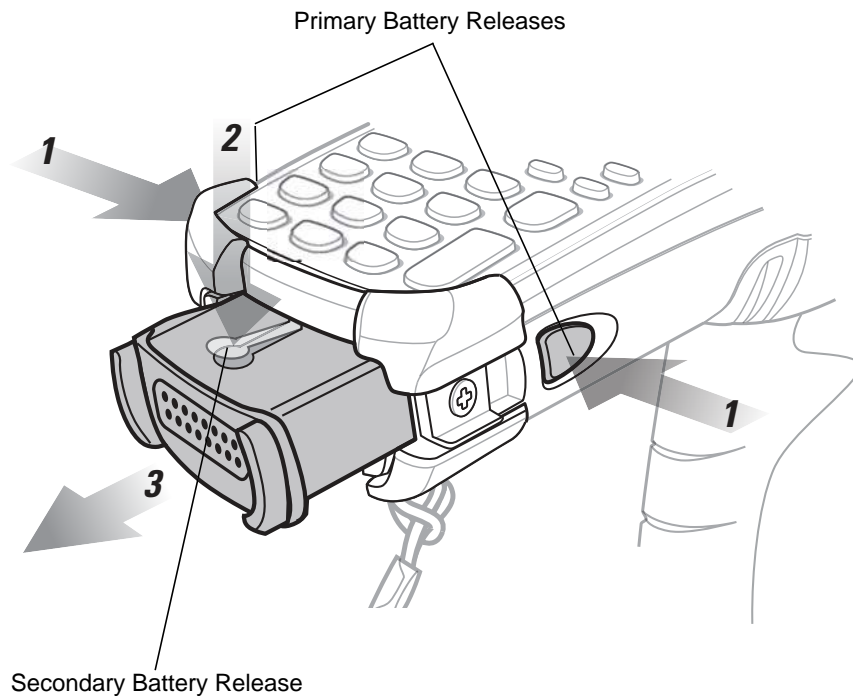

Figure 1-3 *Removing the Main Battery*

Starting the MC92N0-G

Press the red **Power** button to turn on the MC92N0-G. If the MC92N0-G does not power on, perform a cold boot. See [Resetting the MC92N0-G on page 2-24](#) for Windows devices and [Resetting the Android Device on page 3-15](#) for Android devices.

- ✓ **NOTE** When a battery is fully inserted in a MC92N0-G for the first time, upon the MC92N0-G's first power up, the device boots and powers on automatically.

When the MC92N0-G is powered on for the first time, it initializes its system. The splash screen appears for a short period of time.

Calibrating the Screen

Windows Devices

To calibrate the screen so the cursor on the touch screen aligns with the tip of the stylus:

1. Using the stylus carefully press and briefly hold the tip of stylus on the center of each target that appears on the screen.

- ✓ **NOTE** To re-calibrate the screen at anytime, press **FUNC + ESC** on the MC92N0-G to launch the calibration screen application.

2. Repeat as the target moves around the screen or press **ESC** to cancel.

Android Devices

To calibrate the screen so the cursor on the touch screen aligns with the tip of the stylus:

Touch  > **Display** > **Touch calibration**.

1. Using the stylus carefully press and briefly hold the tip of stylus on the center of each target that appears on the screen.
2. Repeat as the target moves around the screen.

Checking Battery Status

To check the charge level of the main battery or backup battery:

- On Windows CE devices, tap **Start** > **Settings** > **Control Panel** > **Power** to display the **Battery Status** window.
- On Windows Embedded Handheld devices, tap **Start** > **Settings** > **System** > **Power** to display the **Power** window.
- On Android devices, touch  > **About device** > **Status**.

To save battery power, set the MC92N0-G to turn off after a specified number of minutes.

MC92N0-G Strap

The strap may be moved to either the left or right side of the MC92N0-G to suit user preferences.

To reposition the strap:

1. Slip the button through the end loop and remove from the handle.
2. Open strap loop and slide the handstrap through the loop.
3. Slide the loop out of the connector post.
4. Reverse the procedure to re-attach the strap. Two strap connectors are provided on the MC92N0-G's main body. The handstrap may be attached to either connector.

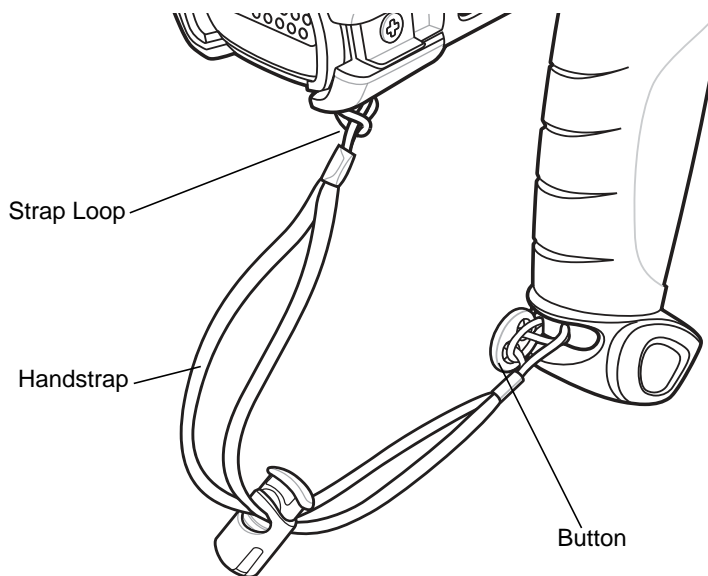

Figure 1-4 *Reposition the Strap*

Battery Management

Battery Saving Tips

- Set the MC92N0-G to turn off after a short period of non-use.
- Set the display to turn off or dim backlight.
- Set the keyboard backlight to turn off after a short period of non-use.
- Turn off all wireless radio activity when not in use.
- Power off the MC92N0-G when charging to charge at a faster rate.

Changing the Power Settings

✓ **NOTE** Windows Mobile and Windows CE only.

To set the MC92N0-G to turn off after a short period of non-use:

1. On Windows CE devices, tap **Start > Settings > Control Panel > Power > Advanced**.
or
On Windows Embedded Handheld devices, tap **Start > Settings > System > Power > Advanced**.
2. Select the **On battery power: Turn off device if not used for:** check box and select a value from the drop-down list box.
3. Tap **OK**.

Changing the Display Backlight Settings

✓ **NOTE** Windows Mobile and Windows CE only.

To change the display backlight settings in order to conserve more battery power:

1. On Windows CE devices, tap **Start > Settings > Control Panel > Backlight > Battery Power**.
or
On Windows Embedded Handheld devices, tap **Start > Settings > System > Backlight > Battery Power**.
2. Select the **On battery power: Disable backlight if not used for:** check box and select a value from the drop-down list box.
3. Tap the **Brightness** tab.
4. Tap the **Disable backlight** check box to completely turn off the display backlight.
5. Use the slider to set the brightness of the backlight. Set it to a low value to save battery power.
6. Tap **OK**.

Changing the Display Brightness

✓ **NOTE** Android Devices only.

To change the display brightness in order to conserve more battery power:

1. Touch  >  **Display > Brightness**.



Figure 1-5 *Brightness Dialog Box*

2. In the Brightness dialog box, use the slider to set a brightness level.
3. Touch .

Changing the Keypad Backlight Settings



Windows Devices

To change the keypad backlight settings in order to conserve more battery power:

1. On Windows CE devices, tap **Start > Settings > Control Panel > Keylight > Battery Power**.
or
On Windows Embedded Handheld devices, tap **Start > Settings > System > Keylight > Battery Power**.
2. Select the **On Battery Power: Disable keylight if not used for:** check box and select a value from the drop-down list box.
3. Tap **Advanced**.
4. Tap the **Disable keylight** check box to completely turn off the display backlight.
5. Tap **OK**.

Android Devices

To change the keypad backlight settings in order to conserve more battery power:

1. Touch  >  **Display > Key light**.
2. Select one of the options.
 - **Always on**- The touch key light is on when the screen is on.
 - **6 seconds**- The touch key light stays on for six seconds then turns off (default).
 - **10 seconds**- The touch key light stays on for 10 seconds then turns off.
 - **15 seconds**- The touch key light stays on for 15 seconds then turns off.
 - **30 seconds**- The touch key light stays on for 30 seconds then turns off.
 - **1 minute**- The touch key light stays on for one minute then turns off.
3. Touch .

Turning Off the Radios

On Windows Embedded Handheld Devices

Windows Embedded Handheld devices include **Wireless Manager**, which provides a simple method of enabling, disabling, and configuring all the device's wireless capabilities in one place.

To open **Wireless Manager**, tap the Status Bar and then the **Connectivity** icon and select **Wireless Manager** or tap **Start > Settings > Connections > Wireless Manager**.

- To enable or disable a wireless connection, tap its blue bar.
- To enable or disable all wireless connections, tap and hold the **All** bar.
- To configure settings for a connection, tap **Menu**.

On Windows CE Devices

WLAN Radio

To turn off the WLAN radio tap the **Fusion Signal Strength** icon on the task tray and select **Disable Radio**. A red X appears across the icon indicating that the radio is disabled (off).



Figure 1-6 *Fusion Signal Strength Icon*

To turn the radio back on, tap the **Fusion Signal Strength** icon on the task tray and select **Enable Radio**. The red X disappears from the icon indicating that the radio is enabled (on).

Bluetooth Radio with StoneStreet One Stack Enabled

To turn off the Bluetooth radio, tap the **Bluetooth** icon in the task tray and select **Disable Bluetooth**.



Figure 1-7 *Bluetooth Icon*

To turn on the Bluetooth radio, tap the **Bluetooth** icon in the task tray and select **Enable Bluetooth**.

On Android Devices

To turn off all the radio:

1. Drag the Status bar down from the top of the screen. The Quick Settings icon displays in the top right corner.
2. Touch  to display the **Quick Settings** panel.
3. Touch **Airplane Mode**.

Drag the bottom of the Quick Settings Panel to the top of the screen to close the Quick Settings screen.

LED Indicators

The MC92N0-G has an LED Indicator Bar that contains LEDs that indicate scanning and charging status. [Table 1-2](#) describes the LED indications.

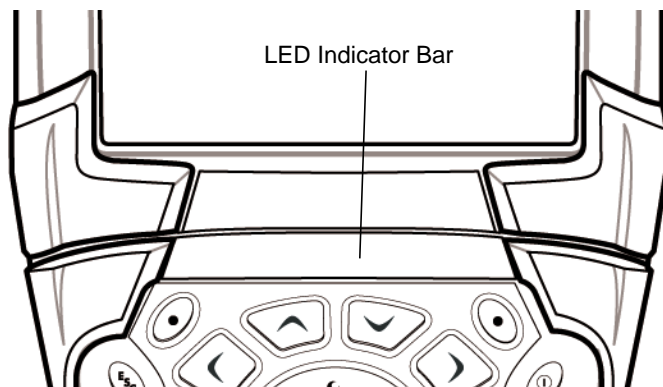

Figure 1-8 MC92N0-G LEDs Indicator Bar

Table 1-2 MC92N0-G LED Indications

LED State	Indication
Solid Red	Laser enabled, scanning/imaging in process.
Solid Green	Successful decode/capture.
Slow Blinking Amber	Main battery in MC92N0-G is charging.
Fast Blinking Amber	Error in charging; check placement of the MC92N0-G.
Solid Amber	Main battery in MC92N0-G is fully charged.

Keypads

The MC92N0-G has the following interchangeable modular keypads:

- 28-key keypad
- 43-key keypad
- 53-key keypad
- 3270 Emulator
- 5250 Emulator
- VT Emulator.

Refer [Appendix B, Keypads](#) for detailed information on each keypad.

Entering Data

When entering data on the keypad, use either the single-hand method or the two-hand method as shown in [Figure 1-9](#).

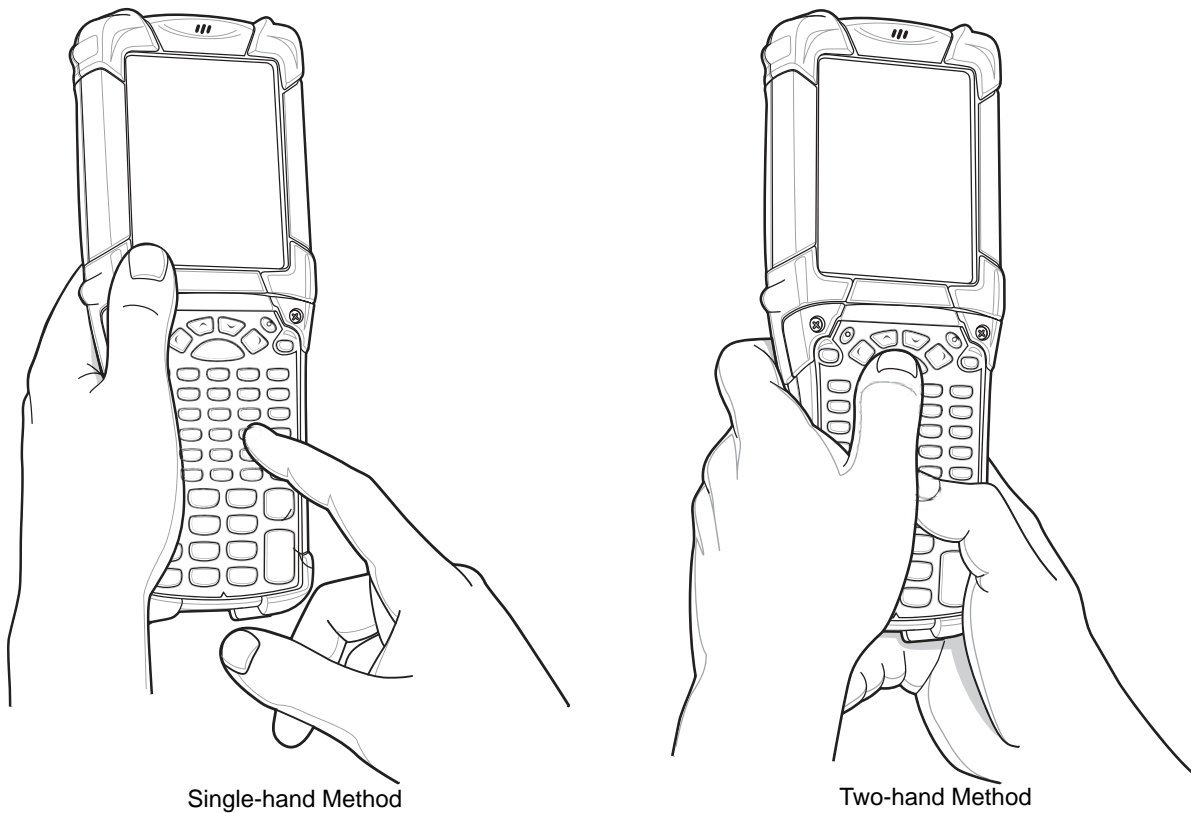

Figure 1-9 *Entering Data on the Keypad*

Using a Wired Headset

You can use a mono headset for audio communication when an audio enabled application is used. To use a headset, plug the headset jack into the audio connector on the side of the MC92N0-G. Ensure that the MC92N0-G's volume is set appropriately before putting the headset on. When a headset is plugged into the jack, the speakerphone is muted.

Zebra recommends a 2.5mm jack headset. See [Table 7-1 on page 7-1](#) for available Zebra headsets.

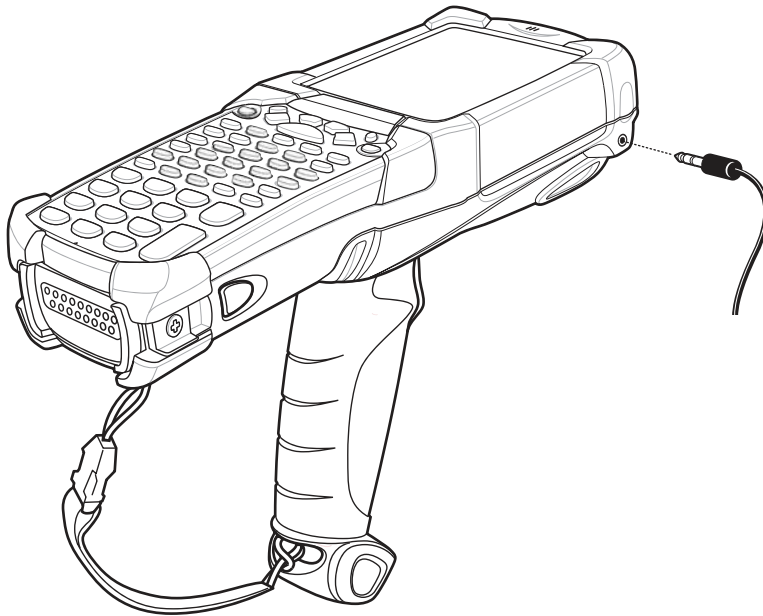

Figure 1-10 *Using a Headset (MC92N0-G Shown)*

Using a Bluetooth Headset

Use a Bluetooth headset for audio communication when an audio enabled application is used. See [Chapter 5, Using Bluetooth on Windows Devices](#) for information on connecting a Bluetooth device to the MC92N0-G. Ensure that the MC92N0-G's volume is set appropriately before putting the headset on. When a Bluetooth headset is connected the speakerphone is muted.

CHAPTER 2 OPERATING THE MC92N0-G WITH WINDOWS OS

Introduction

This chapter explains the physical buttons, status icons and controls on the MC92N0-G, how to use the MC92N0-G, including instructions for powering on and resetting, using the stylus and a headset, entering information and data capture.

Windows CE 7.0

The Taskbar at the bottom of the window displays the active programs, current time, battery status and communication status.

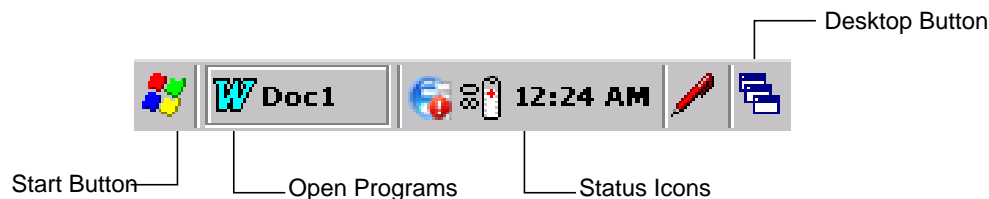













Figure 2-1 Taskbar

Status icons are shown in the taskbar to indicate present status of the MC92N0-G. Double tapping some status icons displays the corresponding setup window and enables you to change or adjust its settings from the window. Single tapping other status icons displays corresponding menus.

Table 2-1 Status Icons

Status Icon	Description
	Clock: Indicates the current time.
	Battery: This icon indicates that the main battery is charging or that the terminal is operating on AC power. Double tapping on this icon opens the Power Properties window.

Table 2-1 Status Icons (Continued)

Status Icon	Description
	AC Plug: Indicates that the battery is fully charged and the MC92N0-G is running on external power.
	Battery: This icon indicates that the battery is fully charged (100% charged). The battery status icons provide the battery status in 10% increments from 10% to 100%.
	Serial Connection: It is displayed when the terminal is connected to a host computer with a serial cable.
	Wireless Connection Status: Indicates WLAN signal strength.
	Bluetooth Enabled: Indicates that the Bluetooth radio is on (BTEplorer only).
	Bluetooth Disabled: Indicates that the Bluetooth radio is off (BTEplorer only).
	Bluetooth Communication: Indicates that the MC92N0-G is communicating with another Bluetooth device (BTEplorer only).
	DataWedge Running: Indicates that the DataWedge application is running.
	DataWedge Idle: Indicates that the DataWedge application is idle.
	Shift: Indicates that the SHIFT button function is selected.
	FUNC: Indicates that the FUNC button function is selected.
	CTRL: Indicates that the CTRL button function is selected.
ALT	ALT: Indicates that the ALT character selection is selected.
ALP	ALPHA: Indicates that the MC92N0-G is in ALPHA button mode is selected.

Start Menu

















To open the Start menu, tap  at the bottom left corner of the screen. [Table 2-2](#) lists the default applications available in the **Programs** menu.

Table 2-2 Applications in the Programs Menu

Icon	Description	Icon	Description
	BattSwap: Use to properly shutdown the MC92N0 during battery replacement.		Fusion Folder: Open the Wireless Companion folder.
	Video Player: Play back video files.		Music Player: Play back audio files.
	BTScanner CtlPanel: Set com port to use with a Bluetooth scanner.		Command Prompt: Opens a DOS command prompt window.
	CtlPanel: View and change MC92N0-G settings such as: Scanner Parameters, Display Settings, Audio Settings, Printer Settings, Date and Time Settings, Touch Screen Settings, etc.		Internet Explorer: Browse Web and WAP sites as well as download new programs and files from the Internet.
	MotoBTUI: Pairs up bar code with the MC92N0-G via Bluetooth and uses the RS507 Hands-free Imager to capture the bar code data.		Microsoft WordPad: Create documents.
	MSP Agent: Interacts with MSP agents to collect monitoring and asset information to enable the configuration, provisioning, monitoring and troubleshooting of the MC92N0-G. Refer to the <i>MC92N0-G Integrator Guide</i> for more information.		Rapid Deployment Client: Facilitates software downloads from a Mobility Services Platform Console FTP server to the MC92N0-G. Refer to the <i>MC92N0-G Integrator Guide</i> for more information.
	Remote Desktop Connection: Log onto Windows NT server type computers and use all of the programs that are available on that computer from the MC92N0-G.		TelnetCE: Opens the Wavelink Telnet client. TelnetCE is pre-licensed on Windows CE devices.
	WarmBoot: Warm boots the MC92N0-G.		Windows Explorer: Organize and manage files on your device.

Control Panel

Table 2-3 lists the applications in the **Control Panel**.

Table 2-3 Programs on the Control Panel



























Icon	Description	Icon	Description
	Backlight: Adjust the backlight brightness and power settings.		Bluetooth Device Properties: Launch the Bluetooth application.
	Certificates: See information about certificates installed on the MC92N0-G.		DataWedge: Sample scanning application. Icon appears after installation.
	Date/Time: Change date, time and time zone information.		Dialing: Set dialing properties for modem communication and change telephony settings.
	Volume & Sounds: Select the type of actions for which to hear sounds and customize notifications for different events.		Display: Change desktop background, appearance, backlight and brightness.
	Error Reporting: Choose whether to MC92N0-G collects software operation information to use if a serious error occurs.		Input Panel: Switch input methods and set input options.
	Internet Options: Control how the MC92N0-G connects to the internet.		IST Settings: Set the appropriate settings for configuring the MC92N0-G's Interactive Sensor Technology.
	Keyboard: Change keyboard repeat delay and rate.		Keypad Light: Adjust keypad light settings.
	Mouse: Adjust double-click sensitivity for both the speed and timing.		Network and Dial-up Connections: Connect to other computers, networks and the Internet using a modem.
	Owner: Change owner's personal profiles.		Password: Set a password for the MC92N0-G.
	PC Connection: Change settings for connectivity of a host computer.		Power: View and control MC92N0-G power settings.
	Regional Settings: Change how numbers, currencies, dates and times appear.		Remove Programs: Remove programs installed on the MC92N0-G.
	Screen Resolution: Sets the screen resolution to either QVGA or VGA. See MC92N0-G Integrator Guide for more information.		Stylus: Calibrate the touch screen and adjust double-tap timing.

Table 2-3 Programs on the Control Panel

Icon	Description	Icon	Description
	System: View system information and change memory settings.		System Info: View information on the MC92N0-G's system components.
	USBConfig: Configure the MC92N0-G USB port.		

Windows Embedded Handheld

The following section describes the operation of the Windows Embedded Handheld operating system.

Finger Scrolling

Windows Embedded Handheld adds finger scrolling capabilities to the display. Finger scrolling can be used to scroll up and down web pages, documents, and lists such as the contacts list, file list, message list, calendar appointments list, and more.

When finger scrolling, swipe or flick your finger on the screen. To scroll down, swipe your finger upward on the screen. To scroll up, swipe your finger downward on the screen. To auto-scroll, flick your finger upward or downward on the screen. Touch the screen to stop scrolling.

Home Screen

The default home screen on the MC92N0-G is the Windows Handheld Home screen. The Home screen contains a Status Bar at the top of the screen and a Tile Bar at the bottom of the screen.

The Home screen is scrollable and contains a list of application plug-ins and an Information Status bar. The Information Status bar highlights the application plug-in that is under it and provides additional information.

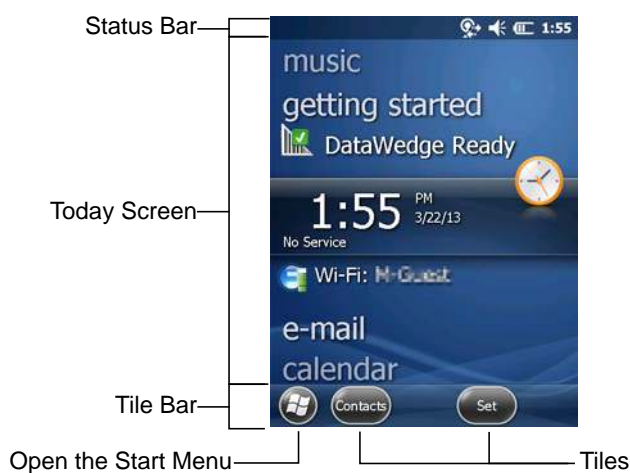

Figure 2-2 Windows Embedded Handheld Home Screen

Touch and hold the screen with your finger and move the Home screen up and down. As the application names move under the Information Status bar, information relevant to that application appear in the bar.



Figure 2-3 Moving Today Screen

Touch and hold the Information Status bar and move it up and down over an application name. Remove your finger and the Information Status bar and application name center in the screen.



Figure 2-4 Moving Information Status Bar

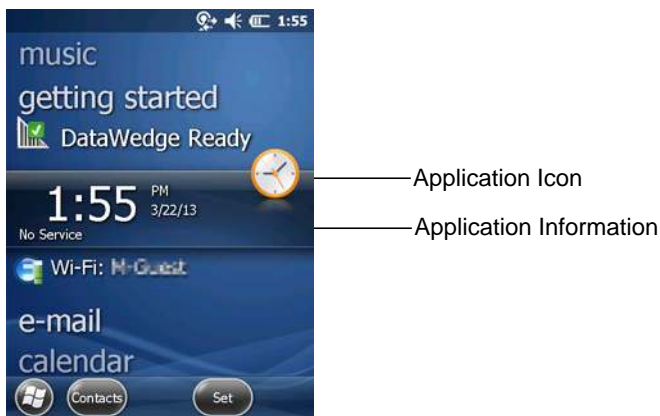



Figure 2-5 Information Bar Example

To customize the **Home** screen, tap  > **Settings** > **Today**. On the horizontal scroll, use **Appearance** to customize the background and the **Items** to change the display format.

Classic Today Screen

The user can change to the classic Today screen layout that is used in Windows Mobile 6.1.



Figure 2-6 Classic Today Screen

To change to the classic view tap > **Settings** > **Home** > **Items**.



Figure 2-7 Home Screen Settings









Deselect the **Windows Default** checkbox and select any of the other checkboxes and then tap .

The task bar at the bottom of the screen can contain the task tray icons listed in [Table 2-4](#).

Table 2-4 Task Tray Icons

Icon	Description
	Wireless connection status: Indicates WLAN signal strength and opens the Wireless Applications menu.
	Bluetooth Enabled: Indicates that the Bluetooth radio is on (Displays only if the StoneStreet One Bluetooth stack is enabled).

Table 2-4 Task Tray Icons (Continued)

Icon	Description
	Bluetooth Disabled: Indicates that the Bluetooth radio is off (Displays only if the StoneStreet One Bluetooth stack is enabled).
	Bluetooth Communication: Indicates that the MC92N0-G is communicating with another Bluetooth device (Displays only if the StoneStreet One Bluetooth stack is enabled).
	ActiveSync: Indicates an active serial connection between the MC92N0-G and the development computer.
	DataWedge Running: Indicates that the DataWedge application is running.
	DataWedge Idle: Indicates that the DataWedge application is idle.
	Shift: Indicates that the SHIFT button function is selected.
	FUNC: Indicates that the FUNC button function is selected.
	CTRL: Indicates that the CTRL button function is selected.
ALT	ALT: Indicates that the ALT character selection is selected.

Status Bar

The Status Bar at the top of the screen displays the status icons listed in [Table 2-5](#).

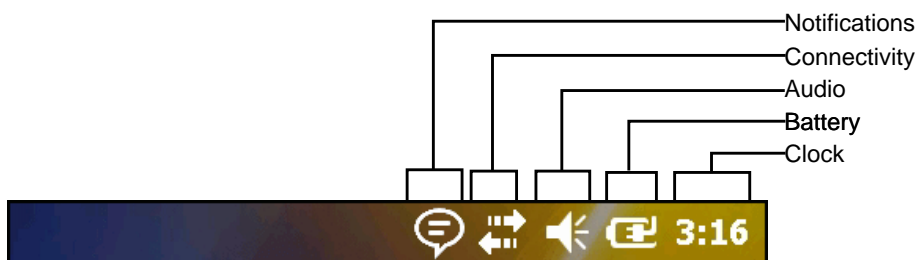

Figure 2-8 Status Bar Icons

Table 2-5 Status Bar Icons

















Icon	Description	Icon	Description
Notifications			
	Indicates a reminder of an upcoming calendar event.		Notification that one or more instant messages were received.

Table 2-5 Status Bar Icons (Continued)





Icon	Description	Icon	Description
	Notification that one or more e-mail/text messages were received.		There are more notification icons than can be displayed.
Connectivity			
	Connection is active.		Connection is not active.
	Synchronization is occurring.		WLAN available.
	WLAN in use.		
Audio			
	All sounds are on.		All sounds are off.
Battery			
	Battery is charging.		Battery has a full charge.
	Battery has a high charge.		Battery has a medium charge.
	Battery has a low charge.		Battery has a very low charge.

Tap the Status Bar to display an Icon bar. Tap an icon to get additional notification or status information.



Figure 2-9 Icon Bar

Table 2-6 *Icon Bar Icons*

Icon	Description
	Magnify: Enlarges the screen.
	Connectivity: Displays the Connectivity dialog box.
	Volume: Displays the Volume dialog box.
	Power: Displays the Power window.
	Clock & Alarms: Opens the Clocks & Alarms window.

Tile Bar



The Tile Bar, located at the bottom of the screen, contains the Start tile  to open the Start Menu. It also displays tiles that vary depending upon the open application.



Figure 2-10 *Tile Bar Examples*

Start Screen

To open the Start screen, tap  at the bottom left corner of the screen.

Swipe upward to view more program and folder icons.

Move often-used program and folder icons anywhere on the Start screen for easy access. Press and hold the icon to move. Drag the icon to a new location and release.

Table 2-7 lists the default icons available on the Start screen.

Table 2-7 *Programs on the Start Screen*







Icon	Description	Icon	Description
	Home: Displays the Home screen.		Text: Send an SMS text message.
	Contacts: Keep track of friends and colleagues.		E-mail: Send an Email.
	Internet Explorer: Browse Web and WAP sites as well as download new programs and files from the Internet.		Battery Swap: Properly shuts down the MC92N0-G during battery replacement.

Table 2-7 Programs on the Start Screen (Continued)























Icon	Description	Icon	Description
	Calendar: Keep track of appointments and create meeting requests.		Settings: Open the Settings folder. <i>Table 2-8</i> lists the default icons available on the Settings folder.
	Pictures & Videos: View and manage pictures, animated GIFs, and video files.		Getting Started: Launch the Getting Started application.
	Windows Media: Play back audio and video files.		Alarms: Set the device clock to the date and time of your locale. Alarms can also be set at specified days and times of a week.
	Marketplace: Purchase applications from the Marketplace.		Messenger: Use this mobile version of Windows Live Messenger.
	Windows Live: Use this mobile version of Windows Live™ to find information on the web.		Calculator: Perform basic arithmetic and calculations, such as addition, subtraction, multiplication, and division.
	MSN Money: Keep track of your finances.		MSN Weather: Check the local weather.
	Tasks: Keep track of your tasks.		Games: Play games.
	Office Mobile: Use the complete suite of Microsoft® Office applications for your mobile device (only on Windows Mobile Premium devices with manufacture date before July 2016).		Notes: Create handwritten or typed notes, drawings, and voice recordings.
	File Explorer: Organize and manage files on your device.		ActiveSync: Synchronize information between the MC92N0-G and a host computer or the Exchange Server.
	Search Phone: Search contacts, data, and other information on the MC92N0-G. Refer to the Microsoft Applications for Windows Mobile 6 User Guide for more information.		Internet Sharing: Connect a notebook computer to the Internet using the MC92N0-G's data connection.
	Help: Access on-line Help topics.		Task Manager: Enables viewing of memory and CPU allocations and stops running processes. Refer to the <i>Microsoft Applications for Windows Mobile 6 User Guide</i> for more information.

Table 2-7 Programs on the Start Screen (Continued)









Icon	Description	Icon	Description
	Adobe Reader: View pdf files.		Wireless Companion: Open the Wireless Companion folder.
	BTScanner CtlPanel: Set com port to use with a Bluetooth scanner.		BTE Explorer: Manages StoneStreet One Bluetooth connections. Refer to the <i>MC92N0-G Series MC92N0-G Integrator Guide</i> for more information. Appears only if the StoneStreet One Bluetooth stack is enabled.
	BT Information: Display information about the Bluetooth radio and generate a Bluetooth address bar code.		MSP Agent: Interacts with MSP agents to collect monitoring and asset information to enable the configuration, provisioning, monitoring and troubleshooting of the MC92N0-G. Refer to the <i>MC92N0-G Integrator Guide</i> for more information.
	Remote Desktop Mobile: Log onto Windows NT server type computers and use all of the programs that are available on that computer from the MC92N0-G.		Rapid Deployment Client: Facilitates software downloads from a Mobility Services Platform Console FTP server to the MC92N0-G. Refer to the <i>MC92N0-G Integrator Guide</i> for more information.
	RTLogExport: Use when instructed to by Zebra support personnel to extract real-time data to a log file. Alternately, press F9 to extract the data to a log file. The log file is located in the /ExportLogs folder.		

Table 2-8 Setting Applications







Icon	Description	Icon	Description
	Clock & Alarms: Set the device clock to the date and time of your locale. Alarms can also be set at specified days and times of a week.		Lock: Set a password for the MC92N0-G.
	Home: Customize the appearance of the Home screen and the information to display on it.		Sounds & Notifications: Enable sounds for events, notifications, and more, and set the type of notification for different events.
	Personal Folder: Contains personal setting applications.		Connections Folder: Contains connection setting applications.
	System Folder: Contains system setting applications.		

Table 2-8 Setting Applications (Continued)





























Icon	Description	Icon	Description
Connections Folder			
	Beam: Set the MC92N0-G to receive incoming beams.		Connections: Set up one or more types of modem connections for your device, such as phone dial-up, Bluetooth, and more, so that your device can connect to the Internet or a private local network.
	Bluetooth: Open the Microsoft or StoneStreet One Bluetooth application, set the MC92N0-G to visible mode and scan for other Bluetooth devices in the area.		Domain Enroll: Make your device an AD domain member for device management and security. Refer to the <i>Microsoft Applications for Windows Mobile 6 User Guide</i> for more information.
	Wi-Fi: Setup wireless network connection and customize settings.		USB to PC: Enables or disables the enhanced network connectivity.
	Wireless Manager: Enables or disables the MC92N0-G's wireless radios and customizes Wi-Fi and Bluetooth settings.		
Personal Folder			
	Buttons: Assign a program to a button.		Owner Information: Enter personal information on the MC92N0-G.
System Folder			
	About: View basic information such as the Windows Handheld [®] version and type of processor used on the MC92N0-G.		Certificates: See information about certificates installed on the MC92N0-G.
	Backlight: Set display backlight brightness and time-out settings.		Customer Feedback: Submit feedback on the Windows Handheld 6 software.
	Encryption: Allow files on a storage card to be encrypted. Encrypted files are readable only on your device.		DataWedge: Sample scanning application.
	Error Reporting: Enable or disable the Microsoft's error reporting function.		IST Settings: Set the appropriate setting for configuring the device's Interactive Sensor Technology.
	Keypad: Set keypad backlight time-out settings.		Memory: Check the device memory allocation status and memory card information and stop currently running programs.
	Managed Programs: Displays the programs that were installed on the MC92N0-G using Mobile Device Manager.		Power: Check battery power and set the time-out for turning off the display to conserve battery power.

Table 2-8 *Setting Applications (Continued)*

Icon	Description	Icon	Description
	Remove Programs: Remove programs that you installed on the MC92N0-G.		Regional Settings: Set the regional configuration to use, including the format for displaying numbers, currency, date, and time on the MC92N0-G.
	Screen: Change the screen orientation, re-calibrate the screen, and change the screen text size.		Task Manager: Stop running programs and processes.
	System Info: Displays the MC92N0-G's software and hardware information.		UI Settings: Sets Start menu grid view.
	USBConfig: Configure the MC92N0-G USB port.		

Speaker Icon

Adjust the system volume using the **Speaker** icon.

1. Tap the Status Bar and then tap the **Speaker** icon. The **Volume** dialog box appears.
2. Tap and move the slide bar to adjust the volume.
3. Select the **On** or **Off** radio button to turn the speaker on or off.

✓ **NOTE** Use can also adjust the system volume using the **Sounds & Notifications** window or by using the keypad.

Locking the MC92N0-G

Lock the MC92N0-G by disabling key presses and screen tap or by requiring a password.

Locking the MC92N0-G turns off keyboard and touch screen functionality. This is helpful when the MC92N0-G is turned on and you want to prevent accidental key presses.

To lock the device, tap  > .

Locking without PIN or Password

When the MC92N0-G is locked, the **Lock** screen appears.



Figure 2-11 *Lock Screen*

Slide the lock button left or right to unlock the screen.

Locking with Simple PIN

When the MC92N0-G is locked, the **Lock** screen appears.



Figure 2-12 *Simple PIN Lock Screen*

Enter the PIN and then tap **Unlock**.

Locking with Strong Password

When the MC92N0-G is locked, the **Lock** screen appears.



Figure 2-13 Strong Password Lock Screen

Enter the strong password and then tap **Unlock**.

Password Locking Setup

Use the **Password** window to set a password to disable unauthorized access to the MC92N0-G.

- ✓ **NOTE** If the MC92N0-G is configured to connect to a network, use a strong (difficult to figure out) password to help protect network security. Password cracking tools continue to improve and the computers used to crack passwords are more powerful than ever.

1. Tap  > **Settings** > **Lock**.



Figure 2-14 Password Window

2. Select **Prompt if device unused for** check box to enable password protection.
3. From the drop-down list, select a time value for the protection to take affect after non-use.
4. From the **Password type**: drop-down list, select either **Simple PIN** or **Strong alphanumeric**.
5. For a simple password, enter a four-digit password in the **Password** field.
For a stronger password:

- a. Enter a seven character password in the **Password:** field. A strong password must contain at least seven characters and contain at least three of the following: uppercase and lowercase letters, numerals, and punctuation.
 - b. Re-enter the password in the **Confirm:** field.
6. Tap .

Using the Power Button

Press the red Power button to turn the MC92N0-G screen on and off (suspend mode). The MC92N0-G is on when the screen is on and the MC92N0-G is in suspend mode when the screen is off. For more information, see *Starting the MC92N0-G on page 1-6*.

The Power button is also used to reset the MC92N0-G by performing a warm or cold boot.

On Windows CE devices:

- Warm Boot - Resets the MC92N0-G.
- Cold Boot - Resets the MC92N0-G, removes all added applications not stored in the Application folder and restores all factory default settings.
- On Windows Embedded Handheld devices:
 - Warm Boot - Resets the MC92N0-G. Operating system and all applications are restarted. File storage is preserved.
 - Cold Boot - Resets the MC92N0-G. Operating system and all applications are restarted. File storage is preserved. Normally only used when a warm boot does not initiate.

✓ NOTE Applications that are added to the Application folder are not removed when a cold boot is performed. The Application folder is in flash memory.

For information about booting the MC92N0-G, see *Windows Embedded Handheld Devices on page 2-25*.

Wireless LAN

✓ NOTE By default, the WLAN is on when the MC92N0-G boots up. To set the WLAN radio to be off when the MC92N0-G boots up, see the *MC92N0-G Integrator Guide*.

To configure the MC92N0-G, a set of wireless applications provide the tools to configure and test the wireless radio in the MC92N0-G. Refer to the *Wireless Fusion Suite User Guide for Version X2.01* for information on configuring wireless profiles. Go to <http://www.zebra.com/support> for the latest version of this guide. See *Software Versions on page xv* to determine the Fusion version on the MC92N0-G.

Windows CE Devices

Tap the **Signal Strength** icon to display the **Wireless Launcher** menu.



Figure 2-15 Wireless Application Menu

Windows Embedded Handheld Devices

- ✓ NOTE On devices with Windows Embedded Handheld, access the Wireless Launcher from the Home screen. Select the Fusion plug-in and then tap the **Fusion Menu** button.

The interface to the **Signal Strength** icon and **Wireless Launcher** has changed in the Windows Embedded Handheld default Today screen. To view the **Wireless Launcher**, select the Fusion plug-in on the Today screen and tap the **Fusion Menu** soft key.



Figure 2-16 Fusion Plug-in on Today Screen

Functionality of this dialog is similar to the **Wireless Launch** menu. Drag the window up and down to view all menu items. Tap the icon next to the item to open it.

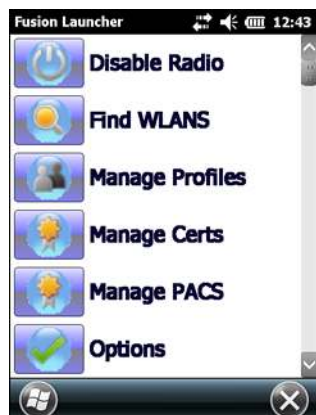

Wireless Launcher Window

Connecting to the Internet

To connect to the Internet on a WLAN when using Fusion Wireless Companion, ensure that the network card settings is set to Internet:

1. Ensure Fusion is enabled and a profile is configured.
2. Tap  > **Settings** > **Connections** > **Wi-Fi**.
3. In the **My network card Connects to** drop-down list, select **The Internet**.
4. Tap **OK**.

Supported Applications

The Fusion menu items and their corresponding applications are summarized in [Table 2-9](#).

Table 2-9 Supported Applications

Application	Description
Find WLANs	Invokes the Find WLANs application which displays a list of the WLANs active in the area.
Manage Profiles	Invokes the Manage Profiles application (which includes the Profile Editor Wizard) to manage and edit the list of WLAN profiles.
Manage Certs	Invokes the Certificate Manager application which allows the user to manage certificates used for authentication.
Manage PACs	Invokes the PAC Manager application which helps the user manage the list of Protected Access Credentials used with Extensible Authentication Protocol-Flexible Authentication via Secure Tunneling (EAP-FAST) authentication.
Options	Invokes the Options application which allows the user to configure the Fusion option settings.

Table 2-9 Supported Applications (Continued)

Application	Description
Wireless Status	Invokes the Wireless Status application which allows the user to view the status of the current wireless connection.
Wireless Diagnostics	Invokes the Wireless Diagnostics application which provides tools with which to diagnose problems with the wireless connection.
Log on/off	Invokes the Network Login dialog which allows the user to log on to a particular profile or to log off from the currently active profile
Fusion Help	Invokes Fusion Help application which provides on-device Help.

Fusion Setup

For detailed WLAN setup using Fusion, refer to the *Wireless Fusion Enterprise Mobility Suite User Guide for Version X2.01*.

To setup WLAN using Fusion:



NOTE Obtain the proper WLAN configuration information from the system administrator prior to performing the Fusion setup procedures.

The following setup procedure example shows setup of a WLAN using Wired Equivalent Privacy (WEP) encryption.

1. Tap the  > **Wireless Companion** > **Wireless Launch** > **Manage Profiles**. The **Manage Profiles** window appears.
2. Tap and hold in the window and select **Add** from the pop-up menu. The **Wireless LAN Profile Entry** window appears.
3. In the **Profile Name** text box enter a name for the profile.
4. In the **ESSID** text box enter the ESSID.

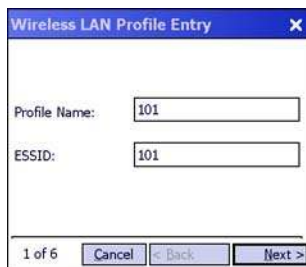

Figure 2-17 Profile ID Dialog Box

5. Tap **Next**. The **Operating Mode** dialog box displays.
6. In the **Operating Mode** drop-down list, select **Infrastructure or Ad-hoc**.

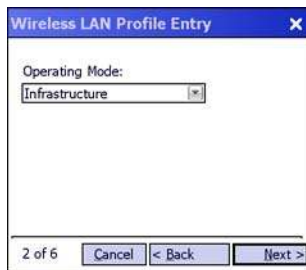

Figure 2-18 *Operating Mode Dialog Box*

7. Tap **Next**. The **Security Mode** dialog box displays.
8. In the **Security Mode** drop-down list, select **Legacy (Pre-WPA)**.



Figure 2-19 *Security/Authentication Dialog Box*

9. In the **Authentication** drop-down list, select **None**.
10. Tap **Next**. The **Encryption** dialog box displays.
11. In the **Encryption Type** drop-down list, select **WEP-40 (40/24)**.



Figure 2-20 *Encryption Dialog Box*

12. Select the **Pass-phrase** or **Hexadecimal Keys** radio button to indicate whether a pass-phrase or hexadecimal keys will be entered on the next page.
13. Select the **For added security - Mask characters entered** check box to hide characters entered. Deselect this to show characters entered.
14. Tap **Next**.



Figure 2-21 WEP-40 WEP Keys Dialog Box

15. In the **Edit Key** drop-down list, select the key to enter.
16. In the **Key** field, enter 10 hexadecimal characters.
17. In the **Confirm** field, re-enter the key. When the keys match, a message appears indicating that the keys match.
18. Repeat for each WEP key.
19. In the **Transmit Key** drop-down list, select the key to transmit.
20. Tap **Next**. The **IPv4 Address Entry** dialog box displays.



Figure 2-22 IP Address Entry Dialog Box

21. Ensure that all three check boxes are selected.
22. Tap **Next**. The **Battery Usage** dialog box appears.
23. In the **Battery Usage Mode** dialog box select a power consumption option.

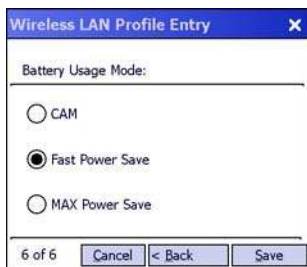

Figure 2-23 Battery Usage Dialog Box

24. Tap **Next**. The **Performance Settings** dialog box appears.
25. In the **Performance Settings** dialog box select either **Optimize for Data** or **Optimize for Voice**.
26. Tap **Save**.

Interactive Sensor Technology

✓ **NOTE** The Interactive Sensor Technology feature is only available on Premium configurations.

This section describes the functionality of the Interactive Sensor Technology (IST) feature on the MC92N0-G.

The IST supports the following features.

- Power Management – manage power by configuring IST to control switching on/off the backlight, control suspend mode of the MC92N0-G by monitoring motion and orientation.
- Display Orientation – switch the screen orientation to either landscape or portrait depending on the MC92N0-G orientation.
- Free Fall Detection – monitors free fall duration and records the time and type of the drop event.

Power Management

The MC92N0-G orientation and motion sensitive data can be used as an indicator of MC92N0-G usage and can be used to manage the battery power of the MC92N0-G. For example, IST can be configured to control the backlight on and off functionality or go into suspend according to a user gesture by placing screen facing down. It can also be used to keep the MC92N0-G active while it is in movement to prevent it from quickly going into suspend mode while in use.

Display Orientation

The screen can be rotated between portrait and landscape modes automatically, depending on the physical orientation of the MC92N0-G. For example, if the MC92N0-G is rotated 90° counterclockwise, IST rotates the display counterclockwise 90° so that the screen display appears correct.

This functionality is achieved by monitoring screen angle and rotating the display to counter any changes. IST only rotates the screen in multiples of 90°.

Free Fall Detection

IST continuously monitors gravitational force on the MC92N0-G according to its current position. When the MC92N0-G free falls, IST detects the absence of gravitational force and records the event data if it detects a free fall more than 450 ms, which may indicate nearly a one meter drop. This data can be used as an indicator of potential abuse or misuse.

IST features a log for recording the free fall events. This log records the date, time and the time period of the free fall.

Using a Wired Headset

You can use a mono headset for audio communication when an audio enabled application is used. To use a headset, plug the headset jack into the audio connector on the side of the MC92N0-G. Ensure that the MC92N0-G's volume is set appropriately before putting the headset on. When a headset is plugged into the jack, the speakerphone is muted.

Zebra recommends a 2.5mm jack headset. See [Table 7-1 on page 7-1](#) for available Zebra headsets.

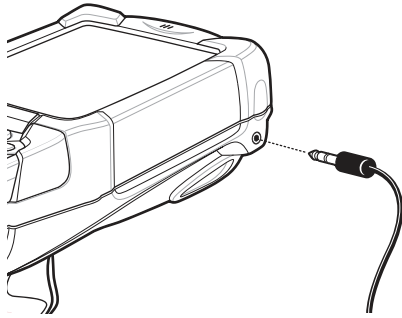

Figure 2-24 Using a Headset (MC92N0-G Shown)

Using a Bluetooth Headset

Use a Bluetooth headset for audio communication when an audio enabled application is used. See [Chapter 5, Using Bluetooth on Windows Devices](#) for information on connecting a Bluetooth device to the MC92N0-G. Ensure that the MC92N0-G's volume is set appropriately before putting the headset on. When a Bluetooth headset is connected the speakerphone is muted.

Resetting the MC92N0-G

Windows CE Devices

There are two reset functions, warm boot and cold boot. A warm boot restarts the MC92N0-G by closing all running programs.

A cold boot also restarts the MC92N0-G, but erases all stored records and entries in RAM. Data saved in flash memory or a memory card is not lost. In addition it returns formats, preferences and other settings to the factory default settings.

Perform a warm boot first. This restarts the MC92N0-G and saves all *stored* records and entries. If the MC92N0-G still does not respond, perform a cold boot.

Performing a Warm Boot

Hold down the Power button for approximately five seconds. As soon as the MC92N0-G starts to perform a warm boot release the Power button.

Performing a Cold Boot

A cold boot restarts the MC92N0-G and erases all user stored records and entries that are not saved in flash memory (Application and Platform folders) or a memory card. *Never perform a cold boot unless a warm boot does not solve the problem.*



CAUTION Do not hold down any key, other than the Power button during a reset. Performing a cold boot restores formats, preferences and other settings to the default settings.



NOTE Any data previously synchronized with a computer can be restored during the next ActiveSync operation.

To perform a cold boot:

1. Press the red **Power** button. The **PowerKey Action** window appears.
2. Tap **Safe Battery Swap**.
3. Press the primary battery release on the MC92N0-G to partially eject the battery from the MC92N0-G.
4. While the battery is partially released, simultaneously press and release the handle trigger and the Power button.
5. Push the battery to fully re-insert it in the MC92N0-G. One audible click can be heard as the battery is fully inserted.
6. The MC92N0-G reboots.
7. Calibrate the screen. See *Calibrating the Screen on page 1-6* to calibrate the MC92N0-G screen.

Windows Embedded Handheld Devices

There are two reset functions, warm boot and cold boot.

- A warm boot restarts the MC92N0-G and closes all running programs.
- A cold boot also restarts the MC92N0-G and closes all running programs but also installs some drivers.

Data saved in flash memory or a memory card is not lost. Perform a warm boot first. This restarts the MC92N0-G and saves all *stored* records and entries. If the MC92N0-G still does not respond, perform a cold boot.

Performing a Warm Boot

Hold down the Power button for approximately five seconds. As soon as the MC92N0-G starts to perform a warm boot release the Power button.

Performing a Cold Boot

A cold boot restarts the MC92N0-G. The operating system and all applications are restarted. File storage is preserved. *Only perform a cold boot if a warm boot does not solve the problem.*

To perform a cold boot:

1. Press the red **Power** button. The **PowerKey Action** window appears.
2. Tap **Safe Battery Swap**. The Indicator LED Bar lights red.
3. Press the primary battery release on the MC92N0-G to partially eject the battery from the MC92N0-G.
4. While the battery is partially released, simultaneously press and release the trigger and the Power button.
5. Push the battery to fully re-insert it in the MC92N0-G. One audible click can be heard as the battery is fully inserted.
6. The MC92N0-G reboots.

Battery Health

The health of the battery can be viewed on the MC92N0-G Power applet.

On Windows CE devices, tap **Start > Settings > Control Panel > Power** icon > **BatteryMgmt** tab. On Windows Embedded Handheld devices, tap **Start > Settings > System > Power > BatteryMgmt** tab.

Table 2-10 *BatteryMgmt Window*

Item	Description
State of Health	Indicates the current state of the battery (Healthy or Unhealthy).
Battery Usage Indicator	Indicates the usage of the battery.
Battery Usage Threshold	Indicates the usage indicator threshold.
Battery Serial #	Displays the serial number of the battery.

For information on changing the Battery Usage Threshold, refer to the *MC92N0-G Mobile Computer Integrator Guide*.

Waking the MC92N0-G

The wakeup conditions define what actions wake up the MC92N0-G after it has gone into suspend mode. The MC92N0-G can go into suspend mode by either pressing the Power button or automatically by Control Panel time-out settings. These settings are configurable and the factory default settings are shown in [Table 2-11](#). To set the wake up conditions on Windows Embedded Handheld devices, tap **Start > Settings > Power > Wakeup** tab or on Windows CE devices, **Start > Settings > Control Panel > Power > Wakeup** tab.

Table 2-11 *Wakeup Default Settings*

Condition for Wakeup	Power Button	Automatic Time-out
MC92N0-G is connected to a serial accessory.	No	Yes
MC92N0-G is connected to a USB device.	Yes	Yes
The scan triggered is pressed.	No	Yes
The screen is touched.	No	No
Bluetooth activity.	Yes	Yes
On Motion	No	Yes
USB Host	No	No
Key is pressed.	No	Yes
Real-time Clock Alarm	Yes	Yes
IST Accelerometer	Yes	Yes



CHAPTER 3 OPERATING THE MC92N0-G WITH ANDROID OS

Introduction

This chapter explains the physical buttons, status icons and controls on the MC92N0-G, how to use the MC92N0-G, including instructions for powering on and resetting, using the stylus and a headset, entering information and data capture.

Home Screen

The Home screen displays when the MC9200 turns on. Depending upon the configuration, the Home screen might appear different. Contact your system administrator for more information.

After a suspend or screen time-out, the Home screen displays with the lock sliders. Slide  to the right toward  to unlock the screen. For screen locking information see *Un-Locking the Screen* on page 3-12.

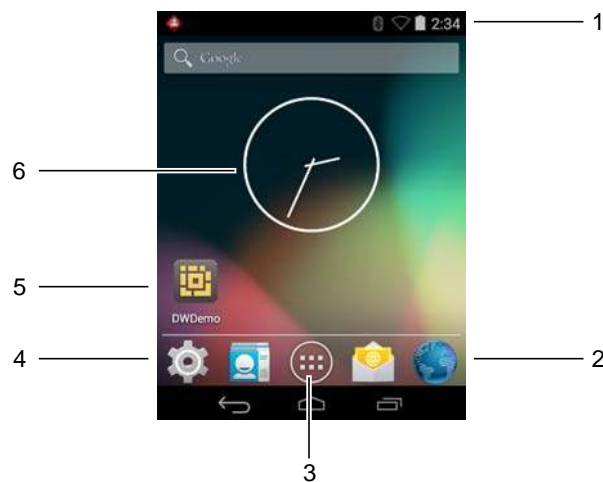

Figure 3-1 Home Screen

Table 3-1 Home Screen Items

Item	Description
1 — Status Bar	Displays the time, status icons (right side), and notification icons (left side). For more information see <i>Status Icons on page 3-2</i> and <i>Managing Notifications on page 3-4</i> .
2 — Browser Icons	Opens Browser application.
3 — All Apps Icon	Opens the APPS window.
4 — Shortcut Icons	Opens applications installed on the MC9200. See <i>Application Shortcuts and Widgets on page 3-6</i> for more information.
5 — Widgets	Launches stand-alone applications that run on the Home screen. See <i>Application Shortcuts and Widgets on page 3-6</i> for more information.

The Home screen provides four additional screens for placement of widgets and shortcuts. Swipe the screen left or right to view the additional screens.

Status Bar

The Status bar displays the time, notification icons (left side) and status icons (right side).

**Figure 3-2** Notification and Status Icons

If there are more notifications than can fit in the Status bar,  displays indicating that more notifications exist. Open the Notifications panel to view all notifications and status.

Status Icons

Table 3-2 Status Icons



















Icon	Description
	Indicates that the Alarm is active.
	Indicates that all sounds except media and alarms are silenced and vibrate mode is active.
	Indicates that the MC92N0-G is in silent mode.
	Indicates that the battery is fully charged.

Table 3-2 *Status Icons (Continued)*

Icon	Description
	Indicates that the battery is partially drained.
	Indicates that the battery charge is low.
	Indicates that the battery charge is very low.
	Indicates that the battery is charging.
	Indicates that the Airplane Mode is active. All radios are turned off.
	Indicates that Bluetooth is on.
	Indicates that the MC9200 is connected to a Bluetooth device.
	Connected to a Wi-Fi network.
	No Wi-Fi signal.
	Indicates that the Alpha key is pressed.
	Indicates that the Blue key is pressed.
	Indicates that the ALT key is pressed.
	Indicates that the CTRL key is pressed.
	Indicates that the Shift key is pressed.
	Indicates that the Shift key is locked.

Notification Icons

Table 3-3 *Notification Icons*















Icon	Description
	Indicates that more notifications are available for viewing.
	Indicates that data is syncing.

Table 3-3 *Notification Icons (Continued)*

Icon	Description
	Indicates an upcoming event.
	Indicates that an open Wi-Fi network is available.
	Indicates that a song is playing.
	Indicates that a problem with sign-in or sync has occurred.
	Indicates that the MC9200 is uploading data.
	Indicates that the MC9200 is downloading data when animated and download is complete when static.
	Indicates that the MC9200 is connected via USB cable.
	Indicates that the MC9200 is connected to or disconnected from virtual private network (VPN).
	Preparing SD card.
	Indicates that USB debugging is enabled on the MC9200.
	Indicates that the MultiUser feature is enabled. Appears only when MultiUser Administrator application is installed.
	Indicates that a new user is logging in. Appears only when MultiUser Administrator application is installed.
	Indicates the status of the PTT Express Voice Client. See <i>Notification Icons on page 3-3</i> for complete list of PTT Express notification icons.

Managing Notifications

Notification icons report the arrival of new messages, calendar events, and alarms, as well as ongoing events. When a notification occurs, an icon appears in the Status bar with a brief description. See *Notification Icons on page 3-3* for a list of possible notification icons and their description. Open the Notifications panel to view a list of all the notifications.

To open the Notification panel drag the Status bar down from the top of the screen.

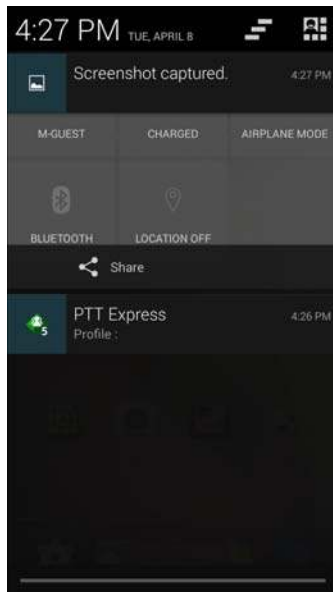



Figure 3-3 *Notification Panel*

To respond to a notification, open the Notifications Panel and then touch a notification. The Notifications Panel closes and the subsequent activity is dependent on the notification.

To clear all notifications, open the Notifications Panel and then touch . All event-based notifications are removed. Ongoing notifications remain in the list.

Touch  to open the Quick Settings screen.

To close the Notification Panel, drag the bottom of the Notifications Panel to the top of the screen or touch .

Quick Settings

The Quick Settings panel provides easy access to some frequently used settings.

Drag the Status bar down from the top of the screen. The Quick Settings icon displays in the top right corner. Touch  to display the **Quick Settings** panel.

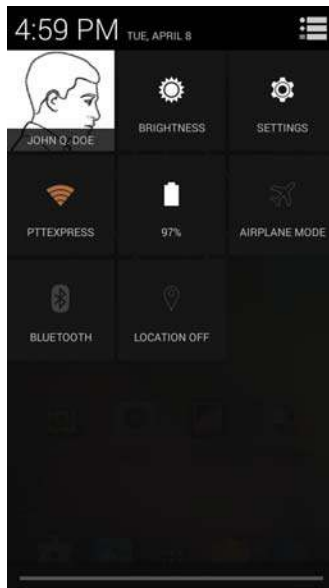



Figure 3-4 Quick Settings

- **Owner**– Display the owner’s contact image. Touch to open the owner’s contact information.
- **Brightness**– Opens the Brightness setting dialog box to set the screen brightness.
- **Settings**– Opens the **Settings** screen.
- **Wi-Fi**– Displays the current Wi-Fi connection. Touch to opens the **Wi-Fi** settings screen.
- **Battery**– Displays the current battery charge level. Touch to opens the **Battery** screen.
- **Airplane Mode**– Displays the Airplane mode status. Touch to toggle Airplane mode on and off. Turn on Airplane mode to turn off all the radios.
- **Bluetooth**– Displays the current state of the Bluetooth radio. Touch to open the **Bluetooth** settings screen.
- **Location**– Displays the current state of the Location settings. Touch to opens the **Location** settings screen.

To close the Quick Settings Panel, drag the bottom of the Quick Settings Panel to the top of the screen, touch  at the top right corner of the screen or touch .

Application Shortcuts and Widgets

Application shortcuts placed on the Home screen allow quick and easy access to applications. Widgets are self-contained applications placed on the Home screen to access frequently used features.

Adding an Application or Widget to the Home Screen

1. Go to the desired Home screen.
2. Touch .
3. Swipe right, if necessary, to find the application icon or widget.
4. Touch and hold the icon or widget until the Home screen appears.
5. Position the icon on the screen and then release.

Moving Items on the Home Screen

1. Touch and hold the item until it floats on the screen.

2. Drag the item to a new location. Pause at the edge of the screen to drag the item onto an adjacent Home screen.
3. Lift finger to place the item on the Home screen.

Removing an App or Widget from the Home Screen

1. Go to the desired Home screen.
2. Touch and hold the application shortcut or widget icon until it floats on the screen.
3. Drag the icon to  **Remove** on the top of the screen and then release.

Folders

Use Folders to organize similar applications together. Tap the folder to open and display items in the folder.

Creating a Folder

To create a folder, there must be at least two app icons on the Home screen.

1. Go to the desired Home screen.
2. Touch and hold on one application icon.
3. Drag the icon and stack on top of another icon.
4. Lift and release.

Naming Folders

1. Touch the folder.

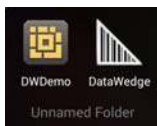

Figure 3-5 *Open Folder*

2. Touch the title area and enter a folder name using the keyboard.
3. Touch **Done**.
4. Touch anywhere on the Home screen to close the folder. The folder name appears under the folder.



Figure 3-6 *Renamed Folder*

Figure 3-6 *Renamed Folder*

Removing a Folder

1. Touch and hold the folder icon until it enlarges and the device vibrates.
2. Drag the icon to  **Remove** and release.

Home Screen Wallpaper

- ✓ **NOTE** Use of Live Wallpaper may reduce battery life.

Changing the Home Screen Wallpaper

- ✓ **NOTE** Use of Live Wallpaper may reduce battery life.



1. On the Home screen, touch and hold until the menu appears.
2. From the **Choose wallpaper from** menu, touch **Gallery**, **Live wallpapers** or **Wallpapers**.
 - **Gallery**- Select to use an image stored on the device.
 - **Live wallpapers**- Select to use an animated wallpaper image.
 - **Wallpapers**- Select to use a wallpaper image.
3. Touch **Save** or **Set wallpaper**.

Using the Touchscreen

Use the multi-tap sensitive screen to operate the device.

- **Tap**- Tap to:
 - select items on the screen
 - type letters and symbols using the on-screen keyboard
 - press on-screen buttons.
- **Tap and Hold**- Tap and hold:
 - an item on the Home screen to move it to a new location or to the trash.
 - an item in Apps to create a shortcut on the Home screen.
 - the Home screen to open a menu for customizing the Home screen.
 - an empty area on the Home screen until the menu appears.
- **Drag**- Tap and hold an item for a moment and then move finger on the screen until reaching the new position.
- **Swipe** Move finger up and down or left and right on the screen to:
 - unlock the screen
 - view additional Home screens
 - view additional application icons in the Launcher window
 - view more information on an application's screen.
- **Double-tap**- Tap twice on a web page, map, or other screen to zoom in and out.

Using the On-screen Keyboard



Use the on-screen keyboard to enter text in a text field. To configure the keyboard settings, touch  (comma) >  and then select **Android keyboard settings**.

Editing Text

Edit entered text and use menu commands to cut, copy, and paste text within or across applications. Some applications do not support editing some or all of the text they display; others may offer their own way to select text.

Entering Numbers, Symbols and Special Characters

To enter numbers and symbols:

- Touch and hold one of the top-row keys until a menu appears then select a number. Keys with alternate characters display an ellipsis (...) below the character.
- Touch and hold the Shift key with one finger, touch one or more capital letters or symbols to enter them, and then lift both fingers to return to the lowercase keyboard.
- Touch  to switch to the numbers and symbols keyboard.
- Touch the  key on the numbers and symbols keyboard to view additional symbols.

To enter special characters, touch and hold a number or symbol key to open a menu of additional symbols.

- A larger version of the key displays briefly over the keyboard.
- Keys with alternate characters display an ellipsis (...) below the character.

Applications

The **APPS** screen displays icons for all installed applications. The table below lists the applications installed on the device. Refer to the *MC9200-G Integrator Guide* for information on installing and uninstalling application.

Table 3-4 Applications







Icon	Description
	App Gallery - Provides links to utilities and demonstration applications that can be installed on the MC9200.
	Battery Manager - Displays battery information, including charge level, status, health and wear level.
	Bluetooth Pairing Utility – Use to pair the RS507 Hans-free Imager with the MC9200 by scanning a bar code.
	Browser - Use to access the Internet or intranet.
	Calculator - Provides the basic and scientific arithmetic functions.
	Calendar - Use to manage events and appointments.
	Clock - Use to schedule alarms for appointments or as a wake-up.

Table 3-4 Applications (Continued)

























Icon	Description
	DataWedge - Enables data capture using the imager.
	Downloads - lists all downloads files.
	DWDemo - Provides a way to demonstrate the data capture features using the imager. See <i>DataWedge Demonstration on page 3-23</i> for more information.
	elemez — Use to provide diagnostic information. See <i>Elemesz on page 3-29</i> for more information.
	Email - Use to send and receive email.
	File Browser - Organize and manage files on the MC9200. See <i>File Browser on page 3-16</i> for more information.
	Gallery - Use to view photos stored on the SD card. For more information, see <i>Gallery on page 3-18</i> for more information.
	MLog Manager - Use to capture log files for diagnostics. See <i>MLog Manager on page 3-28</i> for more information.
	MobiControl Client - Opens the MobiControl Stage application to stage the device.
	MSP Agent - Enables management of the MC9200 from an MSP server. Requires the purchase of an appropriate MSP client license per device to suit the level of management functionality required.
	Music - Play music stored on the SD card.
	People - Use to manage contact information. See <i>People on page 3-17</i> for more information.
	PTT Express - Use to launch PTT Express client for VoIP communication.
	Rapid Deployment - Allows the MC9200 to stage a device for initial use by initiating the deployment of settings, firmware and software. Requires the purchase of an MSP client license per device.
	RxLogger - Use to diagnose device and application issues. See the <i>MC9200 Integrator Guide</i> for more information.
	Search - Use the Google search engine to search the Internet and the MC9200.

Table 3-4 Applications (Continued)

Icon	Description
	Settings - Use to configure the MC9200.
	Sound Recorder - Use to record audio.
	StageNow - Allows the MC9200 to stage a device for initial use by initiating the deployment of settings, firmware and software.
	Terminal Emulation - Opens Wavelink Terminal Emulation application. This application is pre-licensed.
	Velocity - Opens the Wavelink all-touch terminal emulation application. The application is set to demo mode. Contact Wavelink for purchasing licenses.
	AppLock Administrator - Use to configure the Application Lock feature. This icon appears after the optional application is installed.
	MultiUser Administrator - Use to configure the MultiUser feature. This icon appears after the optional application is installed.
	Secure Storage Administrator - Use to configure the Secure Storage feature. This icon appears after the optional application is installed.

Accessing Applications

All applications installed on the device are accessed using the **APPS** window.

1. On the Home screen, touch .



Figure 3-7 APPS Window

2. Slide the **APPS** window left or right to view more application icons. Touch an icon to open the application.



NOTE See *Application Shortcuts and Widgets* on page 3-6 for information on creating a shortcut on the Home screen.

Switching Between Recent Applications



1. Touch and hold . A window appears on the screen with icons of recently used applications.



Figure 3-8 *Recently Used Applications*

2. Slide the window up and down to view all recently used applications.
3. Swipe left or right to remove application from the list and force close the application.
4. Touch an icon to open it or touch  to return to the current screen.



Un-Locking the Screen

Use the Lock screen to protect access to data on the MC9200. Some email accounts require locking the screen. Refer to the *MC9200 Integrator Guide* for information on setting up the locking feature. The Locking feature functions differently in Single User mode or Multiple User mode.

Single User Mode

When locked, a pattern, PIN or password is required to unlock the device. Press the Power button to lock the screen. The device also locks after a pre-defined time-out.

Press and release the Power button to wake the device.

The Lock screen displays. Slide  to the right toward  to unlock the screen.

If the Pattern screen unlock feature is enabled, the Pattern screen appears instead of the Lock screen.

If the PIN or Password screen unlock feature is enabled, enter the PIN or password after unlocking the screen.

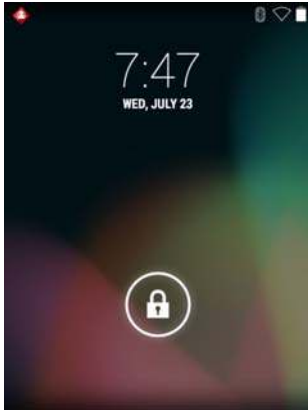

Figure 3-9 *Lock Screen*



Figure 3-10 *PIN Screen*

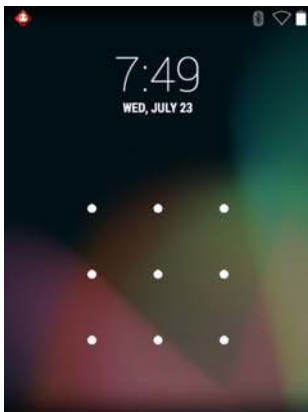

Figure 3-11 *Pattern Screen*



Figure 3-12 Password Screen

MultiUser Mode

With MultiUser login, multiple users can log on to the device with each user having access to various applications and features. When enabled, the Login screen appears after powering on, resetting or after the device wakes from suspend mode.

MultiUser Login

1. In the **Login** text field, enter the username.



Figure 3-13 Multiple User Log In Screen

2. In the **Password** text field, enter the password.
3. Touch **OK**. After a resume from suspend, the user must enter the password.

MultiUser Logout

1. Drag the Status Bar down from the top of the screen.
2. Touch **MultiUser is active**.
3. Touch **Logout**.

4. The **Login** screen appears.

Resetting the Android Device

There are two reset functions, soft reset and hard reset.

Performing a Soft Reset

Perform a soft reset if applications stop responding.

1. Press and hold the Power button until the menu appears.
2. Touch **Reset**.
3. The device shuts down and then reboots.

Performing a Hard Reset



CAUTION Performing a hard reset with a SD card installed in the MC9200 may cause damage or data corruption to the SD card.



To perform a hard reset (if the device is completely non-responsive, skip steps 1 and 2).

1. Press the red **Power** button.
2. Tap **Safe Battery Swap**. The Indicator LED Bar lights red.
3. Press the primary battery release on the MC92N0-G to partially eject the battery from the MC92N0-G.
4. While the battery is partially released, simultaneously press and release the trigger and the Power button.
5. Push the battery to fully re-insert it in the MC92N0-G. One audible click can be heard as the battery is fully inserted.
6. The MC92N0-G reboots.
7. When the screen turns off, release the buttons.
8. The MC9200 reboots.

Suspend Mode

The MC9200 goes into suspend mode when the user presses the Power button or after a period of inactivity (set in the Display settings window).

To wake the MC9200 from Suspend mode, press the Power button. Alternately, press the trigger to wake the device.

The Lock screen displays. Slide  to the right toward  to unlock the screen. If the Pattern screen unlock feature is enabled, the Pattern screen appears instead of the Lock screen. See *Un-Locking the Screen on page 3-12*.



NOTE If the user enters the PIN, password or pattern incorrectly five times, they must wait 30 seconds before trying again.

If the user forgets the PIN, password or pattern contact the system administrator.

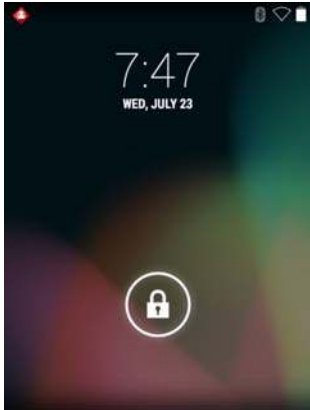

Figure 3-14 Lock Screen

Applications

This section describes the applications installed on the device.

File Browser

Use the **File Browser** application to view and manage files on the device.

To open **File Browser**, touch  > .





Figure 3-15 File Browser Screen

The address bar (1) indicates the current folder path. Touch the current folder path to manually enter a path and folder name.

Use  (2) to select multiple files/folder.

Use  (3) to view the internal storage root folder.







Use  (4) to view the SD card root folder.

Use  (5) to view the previous folder or to exit the application.

Touch and hold an item to perform an operation on that item. Select one of the options from the **File Operations** menu:-

- **Information**- View detailed information about the file or folder.
- **Move**- Move the file or folder to a new location.
- **Copy**- Copy the select file.
- **Delete**- Delete the selected file.
- **Rename**- Rename the select file.
- **Open as**- Open the selected file as a specific file type.
- **Share**- Share the file with other devices.

Touch  to open additional functionality:

- Touch  > **New Folder** to create a new folder in the current folder.
- Touch  > **Search** to search for a file or folder.
- Touch  > **Sort** to sort the list by name, by type, by size or by date.
- Touch  > **Refresh** to re-display the contents of the current folder.
- Touch  > **List View** to change the folder view from tile to list format.
- Touch  > **Change Size** to change the size of the icons: Large, Normal or Small.
- Touch  > **About File Browser** to view the application version information.

People



Use the **People** application to manage contacts.

From a Home or Apps screen, touch . People opens to the main list of contacts. View contacts in three ways at the top of the screen: Groups, All contacts, and Favorites. Touch the tabs to change how to view the contacts. Swipe up or down to scroll through the lists.

Adding People



1. In the People application, touch .
2. If there are more than one account with contacts, touch the one to use.
3. Type the contact's name and other information. Touch a field to start typing, and swipe down to view all categories.
4. To add more than one entry for a category – for example, to add a work address after typing a personal address – touch **Add new** for that field. To open a menu with preset labels, such as Home or Work for an email address, touch the label to the right of the item of contact information. Or, to create your own label, touch **Custom** in the menu.
5. Touch **Done**.

Editing People

1. In the People application, touch  tab.
2. Touch a person to edit.
3. Touch .

4. Touch **Edit**.
5. Edit the contact information.
6. Touch **Done**.

Deleting People

1. In the People application, touch  tab.
2. Touch a person to edit.
3. Touch .
4. Touch **Delete**.
5. Touch **OK** to confirm.



Gallery

✓ **NOTE** The device supports the following image formats: jpeg, gif, png and bmp.

The device supports the following video formats: H.263, H.264 and MPEG4 Simple Profile.

Use Gallery to:

- view photos
- play videos
- perform basic editing of photos
- set photos as wallpaper
- set photos as a contact photo
- share photos and videos.

To open the Gallery application, touch  >  or in the camera application touch the thumbnail image at the top right.

Gallery presents all photos and videos stored on the SD card and internal memory.

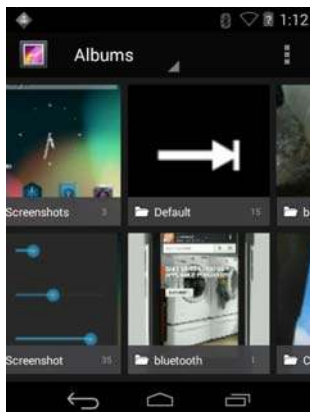



Figure 3-16 Gallery — Albums

- Touch an album to open it and view its contents. The photos and videos in the album are displayed in chronological order.
- Touch a photo or video in an album to view it.
- Touch  icon (top left corner) to return to the main **Gallery** screen.
- Touch  to return to the main **Gallery** screen.

Working with Albums



Albums are groups of images and videos in folders. Touch an album to open it. The photos and videos are listed in a chronologically ordered grid. The name of the album displays at the top of the screen.





Figure 3-17 *Photos Inside an Album*

Swipe left or right to scroll images across the screen.

Share an Album



1. Touch .
2. Touch .
3. Touch and hold an album until it highlights.
4. Touch other albums as required.
5. Touch . The Share menu opens. Touch the application to use to share the selected albums.
6. Follow the instructions within the selected application.

Get Album Information

1. Touch .
2. Touch .
3. Touch and hold an album until it highlights.
4. Touch .
5. Touch **Details**.

Deleting an Album

To delete an album and its contents from the SD card:



1. Touch .
2. Touch .
3. Touch and hold an album until it highlights.
4. Check other albums to delete. Ensure that other albums are selected.
5. Touch .
6. In the **Delete selected item?** menu, touch **OK** to delete the album.

Working with Photos

Use Gallery to view photos on the SD card and edit and share photos.

Viewing and Browsing Photos

To view a photo:

1. Touch .
2. Touch .
3. Touch an album to open it.
4. Touch a photo.

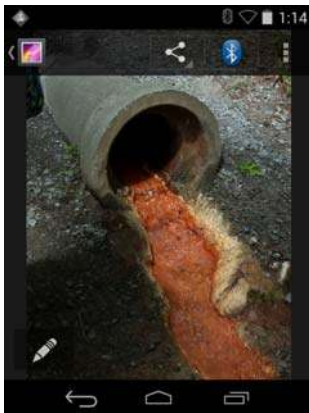



Figure 3-18 *Photo Example*

5. Swipe left or right to view the next or previous photo in the album.
6. Turn the device to view the photo in upright (portrait) or sideways (landscape) orientation. The photo is displayed (but not saved) in the new orientation.
7. Touch the photo to view the controls.
8. Double-tap the screen to zoom in or pinch two fingers together or spread them apart to zoom in or out.
9. Drag the photo to view parts that are not in view.

Cropping a Photo

1. In Gallery, touch a photo to view the controls.
2. Touch .
3. Touch **Crop**. The blue/white cropping tool appears.
4. Use the cropping tool to select the portion of the photo to crop.

- Drag from the inside of the cropping tool to move it.
- Drag an edge of the cropping tool to resize it to any proportion.
- Drag a corner of the cropping tool to resize it with fixed proportions.

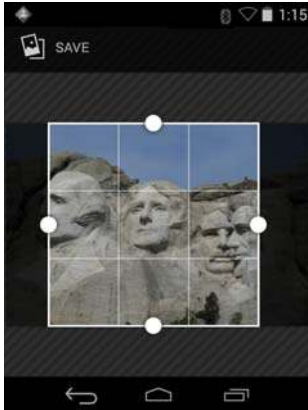







Figure 3-19 *Cropping Tool*

5. Touch **Save** to save a copy of the cropped photo. The original version is retained.

Setting a Photo as a Contact Icon



1. Touch .
2. Touch .
3. Touch an album to open it.
4. Touch the photo to open it.
5. Touch .
6. Touch **Set picture as**.
7. Touch **Contact photo**.
8. In the People application, touch a contact.
9. Touch the blue box and crop the photo accordingly.
10. Touch **OK**.

Share a Photo

1. Touch .
2. Touch .
3. Touch an album to open it.
4. Touch a photo to open it.
5. Touch .
6. Touch the application to use to share the selected photo. The application selected opens with the photo attached to a new message.

Deleting a Photo

1. Touch .

2. Touch .
3. Touch an album to open it.
4. Touch a photo to open it.
5. Touch .
6. Touch .
7. Touch **Delete**.
8. Touch **OK** to delete the photo.

Working with Videos

Use Gallery to view videos on the SD card and share videos.

Watching Videos



1. Touch .
2. Touch .
3. Touch an album to open it.
4. Touch a video.



Figure 3-20 *Video Example*





5. Touch . The video begins to play.







Figure 3-21 *Video Example*

6. Touch the screen to view the playback controls.

Sharing a Video

1. Touch .
2. Touch .
3. Touch an album to open it.
4. Touch a video to open it.
5. Touch . The Share menu appears.
6. Touch the application to use to share the selected video. The application selected opens with the video attached to a new message.

Deleting a Video

1. Touch .
2. Touch .
3. Touch an album to open it.
4. Touch a video to open it.
5. Touch .
6. Touch .
7. Touch **Delete**.
8. Touch **OK**.

DataWedge Demonstration

Use DataWedge Demonstration to demonstrate data capture functionality.



Figure 3-22 *DataWedge Demonstration Window*

Table 3-5 *DataWedge Demonstration Icons*

Icon	Description
	Not applicable.
	Toggles the data capture function between the internal scanner, imager or RS507 Hands-free Bluetooth imager (if connected).
	Toggles between normal scan mode and picklist mode when using the imager to capture bar code data.
	Opens a menu to view the application information or to set the application DataWedge profile.

✓ See the *MC9200 Integrator Guide* for information on DataWedge configuration.

Either press the trigger or touch the yellow scan button to enable data capture. The captured data appears in the text field below the yellow button.

Sound Recorder

Use Sound Recorder to record audio messages.

Recordings are saved on the SD card (if installed) or the Internal Storage and available in the Music application playlist titled "My Recordings."

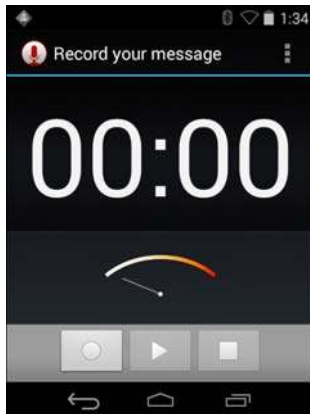

Figure 3-23 *Sound Recorder Application*

PTT Express Voice Client

✓ **NOTE** PTT Express Voice Client creates Push-To-Talk (PTT) communication capability between disparate enterprise devices. Leveraging existing Wireless Local Area Network (WLAN) infrastructure, PTT Express delivers simple PTT communication without the need of a voice communication server.

- **Group Call** Press and hold the green Group Call button to start communicating with other voice client users.
- **Private Response** Press and hold the red Private Call button to respond to the originator of the last broadcast or to make a Private Response.

PTT Audible Indicators

The following tones provide helpful cues when using the voice client.

- **Talk Tone** Double chirp. Plays when the Group (or Private) button is depressed. This is a prompt for the user to start talking.
- **Access Tone** Single beep. Plays when another user just finished a broadcast or response. The user is now able to initiate a Group Call or Private Call.
- **Busy Tone** Continuous tone. Plays when the Group (or Private) button is depressed and another user is already communicating on the same talkgroup. Plays after the maximum allowed talk time is reached (60 seconds).
- **Network Tone**
 - Three increasing pitch beeps. Plays when PTT Express has acquired the WLAN connection and the service is enabled.
 - Three decreasing pitch beeps. Plays when PTT Express has lost the WLAN connection or the service is disabled.

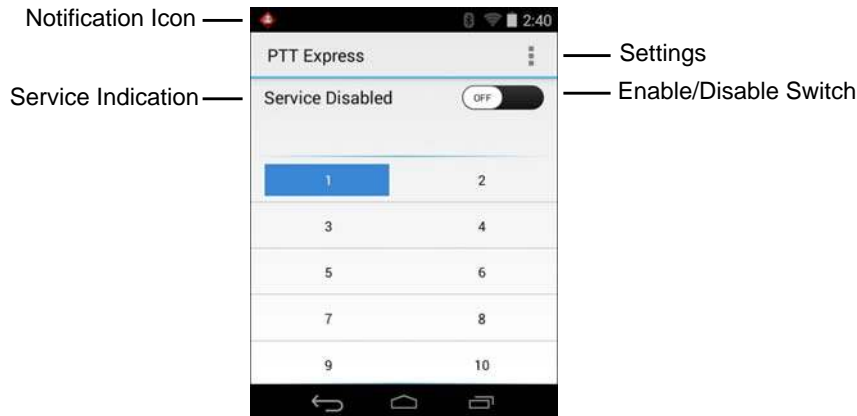

Figure 3-24 PTT Express Default User Interface

Table 3-6 PTT Express Default user Interface Descriptions

Item	Description
Notification Icon	Indicates the current state of the PTT Express client.
Service Indication	Indicates the status of the PTT Express client. Options: Service Enabled , Service Disabled or Service Unavailable .
Talk Groups	Lists all 32 Talk Groups available for PTT communication.
Settings	Opens the PTT Express Settings screen.
Enable/Disable Switch	Turns the PTT service on and off.



Notification Icons

Indicates the current state of the PTT Express Voice client.

Table 3-7 PTT Express Default User Interface Descriptions

Status Icon	Description
	Indicates that PTT Express Voice client is disabled.
	Indicates that PTT Express Voice client is enabled but not connected to a WLAN.
	Indicates that PTT Express Voice client is enabled, connected to a WLAN and listening on the Talk Group indicated by the number next to the icon.
	Indicates that PTT Express Voice client is enabled, connected to a WLAN and communicating on the Talk Group indicated by the number next to the icon.
	Indicates that PTT Express Voice client is enabled, connected to a WLAN and in a private response.

Table 3-7 PTT Express Default User Interface Descriptions

Status Icon	Description
	Indicates that PTT Express Voice client is enabled and muted.
	Indicates that the PTT Express Voice client is enabled but it is not able to communicate due to a VoIP telephony call is in progress.

Selecting a Talk Group

One of 32 Talk Groups can be selected by PTT Express users. However, only one talk group may be enabled at a time on the device. Touch one of the 32 Talk Groups. The selected Talk Group is highlighted.

PTT Communication

- ✓ **NOTE** This section describes the default PTT Express client configuration. See the PTT Express V1.2 User Guide for detailed information on using the client.

PTT communication may be established as a Group Call or Private Call. When PTT Express is enabled, the buttons on the left side of the device are assigned for PTT communication. When the Wired Headset is used, Group Calls and Private Calls can also be initiated using the headset Talk button.

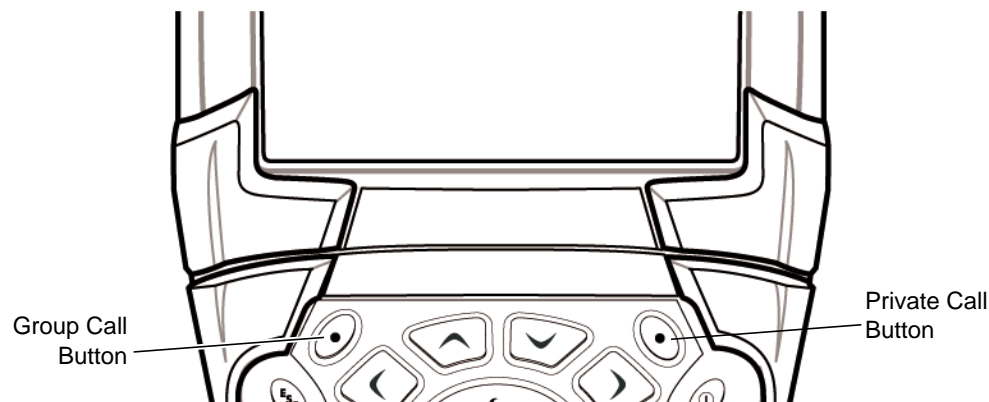
**Figure 3-25** PTT Buttons

Creating a Group Call

1. Press and hold the green Group Call button and listen for the talk tone to play.
2. If a busy tone is heard, release the green Group Call button and wait a moment before making another attempt. Ensure that PTT Express and the WLAN are enabled.
3. Start talking after the talk tone is heard.

- ✓ **NOTE** If the user holds the button for more than 60 seconds (default), the call is dropped allowing others to make Group calls. The user should release the button when finished talking to allow others to make calls.

4. Release the button when finished talking.

Creating a Private Call (One to One)

The Private Call can only be initiated once a Group Call has been established.

The initial Private Call is made to the last talker on the Group Call.

1. Wait until an access tone is heard.
2. Within 10 seconds, press and hold the red Private Call button, and listen for the talk tone to play.
If a busy tone is heard, release the red Private Call button and wait a moment before making another attempt. Ensure that PTT Express and the WLAN are enabled.
3. Start talking after the talk tone plays.
4. Release the Private Call button when finished talking.

Disabling PTT Express Voice Client Communication

1. Touch  > .
2. Slide the **Enable/Disable Switch** to the **OFF** position. The button changes to **OFF**.
3. Touch .

MLog Manager

Use **MLog Manager** to capture log files for diagnostics. See the *MC9200 Integrator Guide* for detailed information on configuring the application.

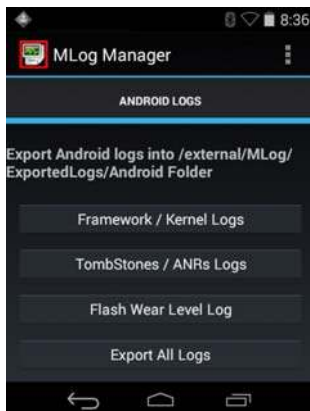

Figure 3-26 MLog Manager

RxLogger

RxLogger is a comprehensive diagnostic tool that provides application and system metrics. It allows for custom plug-ins to be created and work seamlessly with this tool. RxLogger is used to diagnose device and application issues. Its information tracking includes the following: CPU load, memory load, memory snapshots, battery consumption, power states, wireless logging, cellular logging, TCP dumps, Bluetooth logging, logcat, FTP push/pull, ANR dumps, etc. All logs and files generated are saved onto flash storage on the device (internal or external).



Figure 3-27 RxLogger

Elemez

- ✓ **NOTE** Elemez collects specific device information in the background and sends this information to us to help improve product functionality. This feature can be disabled. See *Disabling Elemez Data Collection on page 3-29*.

Ensure that the date, time and time zone are set correctly prior to using Elemez.

Use Elemez to provide diagnostics information to Zebra. Touch **Submit Diagnostics** button to send the data.

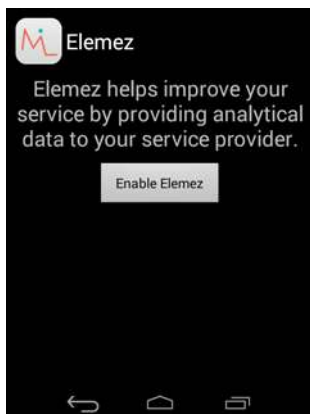



Figure 3-28 Elemez Application

Disabling Elemez Data Collection





The user can disable the Elemez application from collection specific data in the background and sending it to Zebra Technologies.

1. Touch  > **Apps**.
2. Swipe left or right until the **ALL** tab displays.
3. Scroll through the list and touch **Elemez**.
4. In the **App info** screen, touch **Uninstall updates**.
5. In the **Uninstall updates** dialog box, touch **OK**.
6. Touch **OK**.

7. After uninstall is complete, touch **OK**.
8. In the **All** tab, scroll through the list and touch **Elemez**.
9. Touch **Disable**.
10. In the **Disable built-in app?** dialog box, touch **OK**.
11. Touch .

Enabling Elemez Data Collection

The user can re-enable the Elemez application for collection specific data in the background and sending it to Zebra Technologies.

1. Touch  > **Apps**.
2. Swipe left or right until the **ALL** tab displays.
3. Scroll through the list and touch **Elemez**.
4. In the **App info** screen, touch **Enable**.
5. Touch .
6. Touch  > .
7. Touch **Enable Elemez**.

Terminal Emulation

The Wavelink Terminal Emulation application provides a solution for accessing and managing connections to applications resident on host systems using 5250, 3270, VT, and HP emulation.



Figure 3-29 *Wavelink Terminal Emulation*

Velocity

The Wavelink Velocity application provides an all-touch user interface that replaces legacy green screen TE applications.

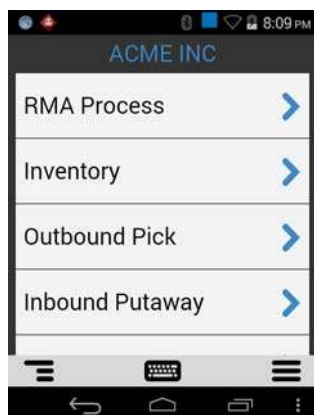

Figure 3-30 Wavelink Velocity Sample Screen

Wireless Local Area Networks

Wireless local area networks (WLANs) allow the MC9200 to communicate wirelessly inside a building. Before using the MC9200 on a WLAN, the facility must be set up with the required hardware to run the WLAN (sometimes known as infrastructure). The infrastructure and the MC9200 must both be properly configured to enable this communication.

Refer to the documentation provided with the infrastructure (access points (APs), access ports, switches, Radius servers, etc.) for instructions on how to set up the infrastructure.

Once the infrastructure is set up to enforce the chosen WLAN security scheme, use the **Wireless & networks** settings configure the MC9200 to match the security scheme.

The MC9200 supports the following WLAN security options:

- Open
- Wireless Equivalent Privacy (WEP).
- Wi-Fi Protected Access (WPA)/WPA2 Personal (PSK).
- Extensible Authentication Protocol (EAP).
 - Protected Extensible Authentication Protocol (PEAP) - with MSCHAPV2 and GTC authentication.
 - Transport Layer Security (TLS)
 - TTLS - with Password Authentication Protocol (PAP), MSCHAP, MSCHAPv2 and GTC authentication.

The **Status** bar displays icons that indicate Wi-Fi network availability and Wi-Fi status. See *Status Bar on page 3-2* for more information.



NOTE Turn off Wi-Fi when not using it, to extend the life of the battery.

Scan and Connect to a Wi-Fi Network

1. Touch .



Figure 3-31 Settings Screen

1. Slide the **Wi-Fi** switch to the **ON** position.
2. Touch  **Wi-Fi**. The MC9200 searches for WLANs in the area and lists them.





Figure 3-32 Wi-Fi Screen

3. Scroll through the list and select the desired WLAN network.
4. For open networks, touch profile once or press and hold and then select **Connect to network** or for secure networks enter the required password or other credentials then touch **Connect**. See the system administrator for more information.
5. The MC9200 obtains a network address and other required information from the network using the dynamic host configuration protocol (DHCP) protocol. To configure the MC92N0-G with a fixed internet protocol (IP) address, See *Configuring the Device to Use a Static IP Address* on page 3-36.
6. In the Wi-Fi setting field, **Connected** appears indicating that the MC92N0-G is connected to the WLAN.

Configuring a Wi-Fi Network

To set up a Wi-Fi network:

1. Touch .

2. Touch  **Wi-Fi**.
3. Slide the switch to the **ON** position.
4. The device searches for WLANs in the area and lists them on the screen.
5. Scroll through the list and select the desired WLAN network.
6. Touch the desired network. If the network security is **Open**, the device automatically connects to the network. For all other network security a dialog box appears.

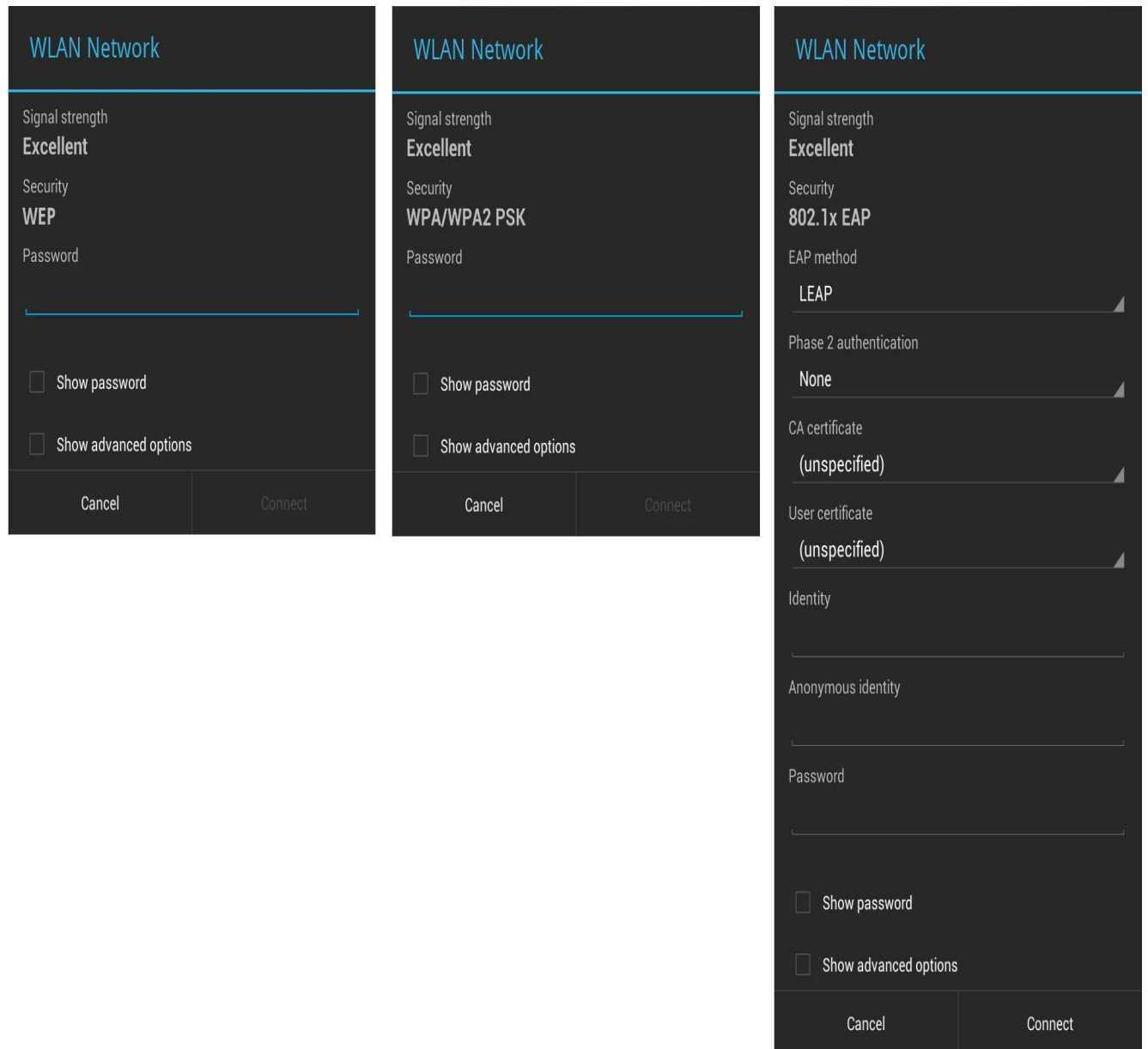

Figure 3-33 WLAN Network Security Dialog Box

7. If the network security is **WEP** or **WPA/WPS2 PSK**, enter the required password and then touch **Connect**.
8. If the network security is 802.1x EAP:
 - Touch the EAP method drop-down list and select **PEAP**, **TLS**, **TTLS**, **LEAP** or **FAST**.

- Touch the **Phase 2 authentication** drop-down list and select an authentication method.
- If required, touch **CA certificate** and select a Certification Authority (CA) certificate. Note: Certificates are installed using the **Security** settings.
- If required, touch **User certificate** and select a user certificate. Note: User certificates are installed using the Location & security settings.
- If required, in the **Identity** text box, enter the username credentials.
- If desired, in the **Anonymous identity** text box, enter an anonymous identity username.
- If required, in the **Password** text box, enter the password for then given identity.





NOTE By default, the network Proxy is set to **None** and the IP settings is set to **DHCP**. See *Configuring for a Proxy Server* on page 3-35 for setting connection to a proxy server and see *Configuring the Device to Use a Static IP Address* on page 3-36 for setting the device to use a static IP address.

9. Touch **Connect**.

10. Touch .

Manually Adding a Wi-Fi Network

Manually add a Wi-Fi network if the network does not broadcast its name (SSID) or to add a Wi-Fi network when out of range.

1. Touch .
2. Touch  **Wi-Fi**.
3. Slide the Wi-Fi switch to the **On** position.
4. Touch **+** in the top right corner of the screen.
5. In the **Network SSID** text box, enter the name of the Wi-Fi network.
6. In the **Security** drop-down list, select the type of security. Options:
 - None
 - WEP
 - WPA/WPA2 PSK
 - **802.1x EAP**
7. If the network security is **None**, touch **Save**.
8. If the network security is **WEP** or **WPA/WPA2 PSK**, enter the required password and then touch **Save**.
9. If the network security is **802.1x EAP**:
 - Touch the **EAP method** drop-down list and select **PEAP**, **TLS**, **TTLS**, **LEAP** or **FAST**.
 - Touch the **Phase 2 authentication** drop-down list and select an authentication method.
 - If required, touch **CA certificate** and select a Certification Authority (CA) certificate. Note: Certificates are installed using the **Security** settings.
 - If required, touch **User certificate** and select a user certificate. Note: User certificates are installed using the **Security** settings.
 - If required, in the **Identity** text box, enter the username credentials.
 - If desired, in the **Anonymous** identity text box, enter an anonymous identity username.

- If required, in the **Password** text box, enter the password for then given identity.

✓ By default, the network Proxy is set to **None** and the IP settings is set to **DHCP**. See *Configuring for a Proxy Server* on page 3-35 for setting connection to a proxy server and see *Configuring the Device to Use a Static IP Address* on page 3-36 for setting the device to use a static IP address.

1. Touch **Connect**.
2. Touch .

Configuring for a Proxy Server

A proxy server is a server that acts as an intermediary for requests from clients seeking resources from other servers. A client connects to the proxy server, requesting some service, such as a file, connection, web page, or other resource, available from a different server. The proxy server evaluates the request according to its filtering rules. For example, it may filter traffic by IP address or protocol. If the request is validated by the filter, the proxy provides the resource by connecting to the relevant server and requesting the service on behalf of the client.

It is important for enterprise customers to be able to set up secure computing environments within their companies, and proxy configuration is an essential part of doing that. Proxy configuration acts as a security barrier ensuring that the proxy server monitors all traffic between the Internet and the intranet. This is normally an integral part of security enforcement in corporate firewalls within intranets.

1. In the network dialog box, touch a network.
2. Touch **Show advanced options** checkbox.
3. Touch **Proxy settings** and select **Manual**.

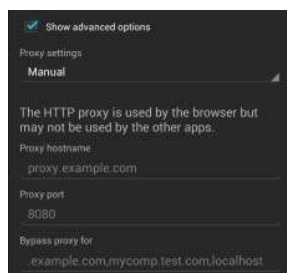



Figure 3-34 *Proxy Settings*

4. In the **Proxy hostname** text box, enter the address of the proxy server.
5. In the **Proxy port** text box, enter the port number for the proxy server.

✓ **NOTE** When entering proxy addresses the Bypass proxy for field, do not use spaces or carriage returns between addresses.

6. In the **Bypass proxy for** text box, enter addresses for web sites that do not require to go through the proxy server. Use the separator “|” between addresses.
7. Touch **Connect**.
8. Touch .

Configuring the Device to Use a Static IP Address

By default, the device is configured to use Dynamic Host Configuration Protocol (DHCP) to assign an Internet protocol (IP) address when connecting to a wireless network. To configure the device to connect to a network using a static IP address:

1. In the network dialog box, touch a network.
2. Touch **Show advanced options** checkbox.
3. Touch **IP settings** and select **Static**.

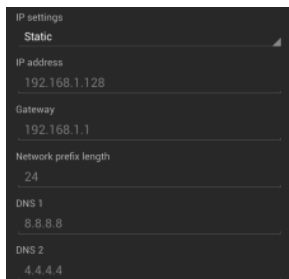



Figure 3-35 Static IP Settings

4. In the **IP address** text box, enter an IP address for the device.
5. If required, in the **Gateway** text box, enter a gateway address for the device.
6. If required, in the **Network prefix length** text box, enter a the prefix length.
7. If required, in the **DNS 1** text box, enter a Domain Name System (DNS) address.
8. If required, in the **DNS 2** text box, enter a DNS address.
9. Touch **Connect**.
10. Touch .

Advanced Wi-Fi Settings

✓ **NOTE** Advanced Wi-Fi settings are for the device not for a specific wireless network.

Use the **Advanced** settings to configure additional Wi-Fi settings. From the **Wi-Fi** screen, touch  > **Advanced** to view the advanced settings.

- General
 - **Network notification**- When enabled, notifies the user when an open network is available.
 - **Keep Wi-Fi on during sleep**- Opens a menu to set whether and when the Wi-Fi radio turns off.
 - **Always On**- The radio stays on when the device enters suspend mode (default).
 - **Only when plugged in**- The radio stays on while the device is connected to external power.
 - **Never On**- The radio turns off when the device enters suspend mode.
 - **Install Certificates**– Touch to install certificates.
 - **Wi-Fi optimization**– Touch to minimize battery usage when Wi-Fi is on (default – disabled)
 - **MAC address**- Displays the Media Access Control (MAC) address of the device when connecting to Wi-Fi networks.

- Regulatory
 - **Country selection**- Displays the acquired country code if 802.11d is enabled else it displays the currently selected country code.
- Band and Channel Selection
 - **Wi-Fi frequency band**- Use to select the frequency band. Options: **Auto** (default), **5 GHz only** or **2.4 GHz only**.
 - **Available channels (2.4 GHz)**- Use to select specific channels. Touch to display the **Available channels** menu. Select specific channels. Touch **OK**.
 - **Available channels (5 GHz)**- Use to select specific channels. Touch to display the **Available channels** menu. Select specific channels. Touch **OK**.
- Logging
 - **Advanced Logging**– Touch to enable advanced logging. Advanced logging
 - **Wireless logs**- Use to capture Wi-Fi log files.
 - **Fusion Logger**- Touch to open the **Fusion Logger** application. This application maintains a history of high level WLAN events which helps to understand the status of connectivity.



Figure 3-36 Fusion Logger Screen

- **Fusion Status**- Touch to display live status of WLAN state. Also provides information of device and connected profile.





Figure 3-37 Fusion Status Screen

- About
 - **Version**- Displays the current Fusion information.

Remove a Wi-Fi Network

To remove a remembered or connected network:

1. Touch .
2. Touch  **Wi-Fi**.
3. In the **Wi-Fi networks** list, touch and hold the name of the network.
4. In the menu, touch **Forget network**.
5. Touch .

CHAPTER 4 DATA CAPTURE

The MC92N0-G has integrated laser scanners or imagers that collect data by scanning bar codes.

- SE-965 Standard Range Laser
- SE1524-ER Extended Range Laser
- SE4500-SR Standard Range Imager
- SE4500-DL - Driver License Imager (Windows only)
- SE4500-HD - High Density Imager (DPM) (Windows only)
- SE4750-SR Standard Range Imager (Premium only)
- SE4750-MR Mid-Range Imager (Premium only)
- SE4600-LR Long Range Imager (Windows only)
- SE4850-ER Extended Range Imager.

Scan LED Indicators

The red/green Scan LED Indicators (located in the Indicator LED Bar) indicates the scan status. For the location of the Scan LED Indicators see, [Figure 1-1 on page 1-1](#).

Table 4-1 Scan LED Indicators

LED Status	Indication
Off	Not scanning.
Solid Red	Laser enabled, scanning in process.
Solid Green	Successful decode.

Laser Scanning

To read a bar code, a scan-enabled application is required. The MC92N0-G contains the **DataWedge** and **ScanSample** (Windows CE devices only) applications that allows the user to enable the scanner to decode bar code data and display the bar code content. See [DataWedge on page 4-7](#) for information on enabling **DataWedge** and [ScanSample on page 4-8](#) for launching **ScanSample** application.

1. Launch a scanning application or a sample scanning application (**DataWedge** or **ScanSample**).
2. Point the exit window on the top of the MC92N0-G at a bar code.
3. Press the trigger or scan button. Ensure the red scan beam covers the entire bar code. The Scan LED Indicators illuminate red to indicate that the laser is on. The Scan LED Indicators illuminate green and a beep sounds to indicate a successful decode.



Figure 4-1 *Laser Aiming*

4. Release the trigger or scan button.

Scanning Considerations

Scanning consists of; aim, scan and decode. Scanning performance can be optimized by considering the range and the scanning angle:

- Range

Any scanning device decodes well over a particular working range (minimum and maximum distances from the bar code). This range varies according to bar code density and scanning device optics.

Scanning within range brings quick and constant decodes; scanning too close or too far away prevents decodes. Move the scanner closer and further away to find the right working range for the bar codes being scanned. However, the situation is complicated by the availability of various integrated scanning modules. The best way to specify the appropriate working range per bar code density is through a chart called a decode zone for each scan module. A decode zone simply plots working range as a function of minimum element widths of bar code symbols.

- Angle

The scan angle is important for optimizing decode performance. When laser beams reflect directly back into the scanner from the bar code, this specular reflection can “blind” the scanner.

To avoid this, scan the bar code so that the beam does not bounce directly back. But do not scan at too sharp an angle; the scanner needs to collect scattered reflections from the scan to make a successful decode. Practice quickly shows what tolerances to work within.



NOTE Contact the Zebra Support if chronic scanning difficulties develop. Decoding of properly printed bar codes should be quick and effortless.

Imaging

The MC92N0-G with an integrated imager has the following features:

- Omnidirectional (360°) reading of a variety of bar code symbologies, including the most popular linear, postal, PDF417, and 2D matrix code types.
- The ability to capture and download images to a host for a variety of imaging applications.
- Advanced intuitive laser aiming for easy point-and-shoot operation.

The imager uses digital camera technology to take a digital picture of a bar code, stores the resulting image in its memory, and executes state-of-the-art software decoding algorithms to extract the data from the image.

Operational Modes

The MC92N0-G with an integrated imager supports three modes of operation, listed below. Activate each mode pressing the Scan button.

- Decode Mode: In this mode, the MC92N0-G attempts to locate and decode enabled bar codes within its field of view. The imager remains in this mode as long as you hold the scan button, or until it decodes a bar code.



NOTE To enable Pick List Mode, use the CtlPanel applet on Windows CE or download the Windows Mobile Control Panel applet from the Support Central web site at <http://www.zebra.com/support>. Pick List can also be set in an application using a API command.

- Pick List Mode: This mode allows you to selectively decode a bar code when more than one bar code is in the MC92N0-G's field of view. To accomplish this, move the aiming crosshair center dot over the required bar code to decode only that bar code. This feature is ideal for pick lists containing multiple bar codes and manufacturing or transport labels containing more than one bar code type (either 1D or 2D).
- Image Capture Mode: Use this mode to capture an image within the MC92N0-G's field of view. This is useful for capturing signatures or images of items like damaged boxes.

Imager Scanning

To read a bar code, a scan-enabled application is required. The MC92N0-G contains the **DataWedge** and **ScanSample** (Windows CE devices only) application that allows the user to enable the scanner to decode bar code data and display the bar code content. See *DataWedge on page 7* for more information on launching DataWedge and *ScanSample on page 4-8* for launching ScanSample.

1. Launch a scanning application or a sample scanning application (**DataWedge** or **ScanSample**).
2. Point the exit window on the top of the MC92N0-G at a bar code.
3. Press the trigger or scan button. Ensure the red scan beam covers the entire bar code. The Scan LED Indicators illuminate red to indicate that the laser is on. The Scan LED Indicators illuminate green and a beep sounds to indicate a successful decode.

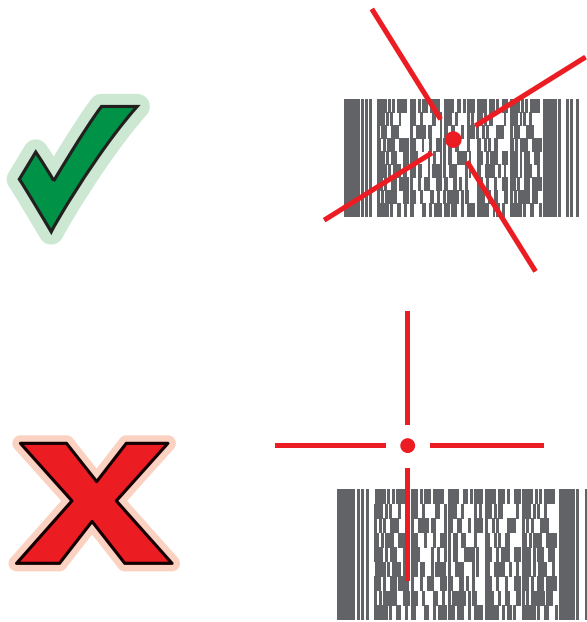

Figure 4-2 *Standard Range/Mid-Range Imager Aiming Pattern*

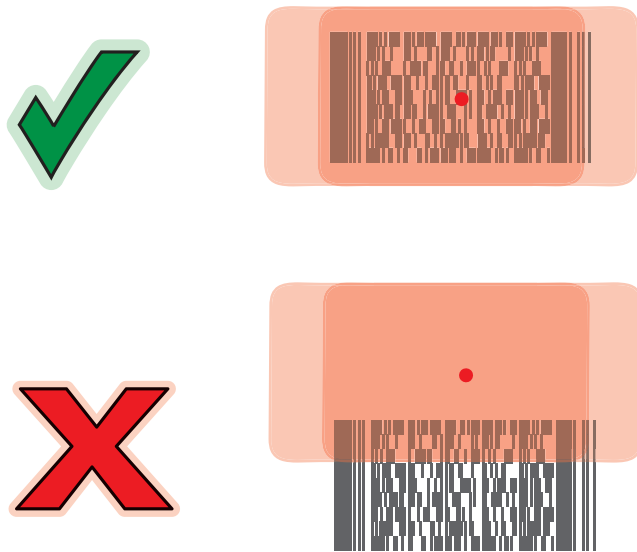

Figure 4-3 *Long Range Imager Aiming Pattern*

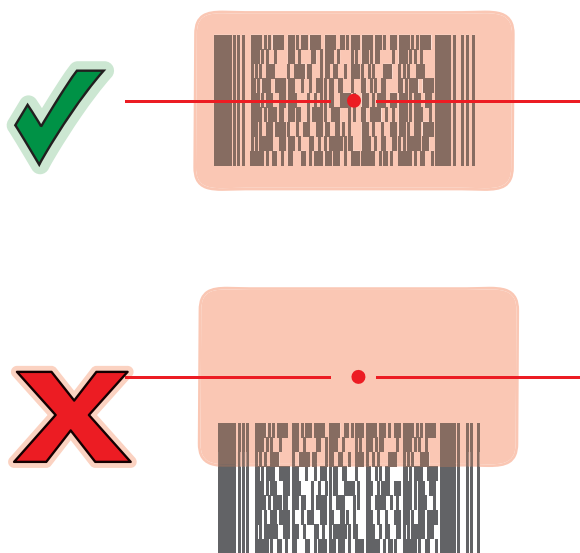

Figure 4-4 *Extended Range Imager Aiming Pattern*

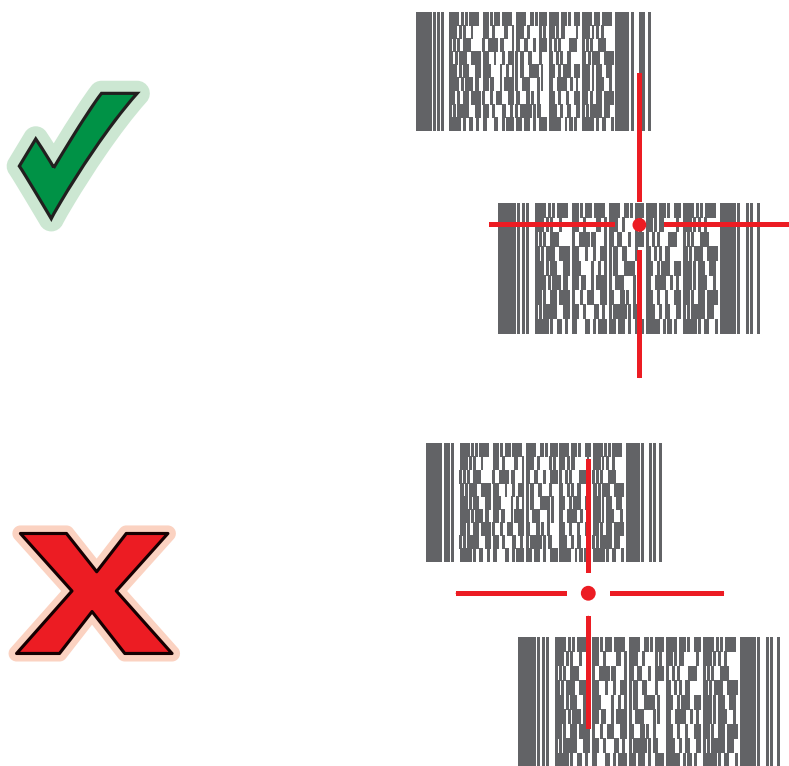

Figure 4-5 *Standard Range/Mid-Range Imager Pick List Mode with Multiple Bar Codes*



Figure 4-6 Long Range Pick List Mode with Multiple Bar Codes



Figure 4-7 Extended Range Pick List Mode with Multiple Bar Codes

4. Release the scan button.

Image Capture

To capture an image, an image capture application is required.

1. Launch an image capture application.
2. Point the exit window on the top of the MC92N0-G toward the object to capture.
3. Press the trigger or scan button. The captured image appears on the screen.

DataWedge







NOTE DataWedge can also be accessed from the desktop on Windows CE configurations or on the Home screen on Windows Embedded Handheld configurations.

Enable DataWedge

To enable DataWedge on Windows CE or Embedded Handheld devices:

1. On Windows CE devices, double-tap the icon on the desktop or tap **Start > Settings > Control Panel > DataWedge**, or on Windows Embedded Handheld devices, tap **Start > Settings > System > DataWedge**.
2. Tap **Basic configuration > 1. Barcode input**.
3. Tap **1. 1D Scanner Driver, 1. Block Buster Imager** or **2. Bluetooth SSI Scanner Driver**.
4. Ensure that a check mark is next to **1. Enabled**. If not, tap **1. Enabled**.
5. Tap **OK**.
6. Tap **Running** to start the DataWedge process. The DataWedge Status changes to Ready.
7. Tap **OK**.

To enable DataWedge on Android devices:



1. Touch .
2. Touch .
3. Touch .
4. Touch **Settings**.
5. Touch the **DataWedge enabled** checkbox. A blue checkmark appears in the checkbox indicating that DataWedge is enabled.
6. Touch .

Disable DataWedge

To disable DataWedge on Windows CE or Embedded Handheld devices:

1. On Windows CE devices, double-tap the icon on the desktop or tap **Start > Settings > Control Panel > DataWedge**, or on Windows Embedded Handheld devices, tap **Start > Settings > System > DataWedge**.
2. Tap the **Running** option to end the DataWedge process. The DataWedge Status changes to **Stopped**.
3. Tap **OK**.

To disable DataWedge on Android devices:

1. Touch .
2. Touch .
3. Touch .
4. Touch **Settings**.
5. Touch the **DataWedge enabled** checkbox. The blue checkmark disappears from the checkbox indicating that DataWedge is disabled.

6. Touch .

ScanSample

- ✓ **NOTE** ScanSample is only available on Windows CE devices.

To launch **ScanSample**:

1. Tap **Start > Programs > Samples**.
2. Double-tap **Scan** icon.
3. Press **1** key or tap **Scan**.

To exit the ScanSample application:

1. Press **0** key or tap **[Back]**.
2. Press **0** key or tap **[Exit]**.

Using the RS507 Hands-free Imager

An RS507 Hands-free Imager can be used with the MC92N0-G to capture bar code data.

- ✓ **NOTE** Only one RS507 can be paired with the MC92N0-G at a time.

To set up the RS507:

1. On Windows CE devices, tap **Start > Programs > BTScannerCtlPanel** or on Windows Embedded Handheld devices, tap **Start > BTScannerCtlPanel**.
2. If required, select the **BT Scanner** checkbox and then select the appropriate Com port from the drop-down list.
3. Tap **Save and Exit**.
4. On Windows CE devices, tap **Start > Programs > MotoBTUI** or on Windows Embedded Handheld devices, tap **Start > MotoBTUI**.
5. Tap **Pairing Barcode**. A bar code displays.

- ✓ **NOTE** If the MC92N0-G with Windows CE is set to VGA mode the RS507 cannot read the bar code due to the smaller bar code size. Refer to the *RS507 Hands-free Imager Product Reference Guide* for instruction for printing a pairing bar code.

6. Point the RS507 at the bar code. The RS507 reads the bar code and begins pairing with the MC92N0-G.

Refer to the *RS507 Hands-free Imager Product Reference Guide* for more information.

Pairing the RS507 Hands-Free Imager using Android HID



An RS507 Hands-free Imager can be used with the device to capture bar code data.

1. Ensure that Bluetooth is enabled on both devices.

2. Ensure that the Bluetooth device to discover is in discoverable mode.
3. Ensure that the two devices are within 10 meters (32.8 feet) of one another.
4. Place the RS507 in Human Interface Device (HID) mode. If the RS507 is already in HID mode, skip to step 5.
 - a. Remove the battery from the RS507.
 - b. Press and hold the Restore key.
 - c. Install the battery onto the RS507.
 - d. Keep holding the Restore key for about five seconds until a chirp is heard and the Scan LEDs flash green.
 - e. Scan the bar code below to place the RS507 in HID mode.





Figure 4-8 *RS507 Bluetooth HID Bar Code*

5. Remove the battery from the RS507.
6. Re-install the battery into the RS507.
7. On the MC9200-G, touch .
8. Touch  **Bluetooth**.
9. Touch **SCAN FOR DEVICES**. The device begins searching for discoverable Bluetooth devices in the area and displays them under **AVAILABLE DEVICES**.
10. Scroll through the list and select RS507.

The device connects to the RS507 and **Connected** appears below the device name. The Bluetooth device is added to the **Bluetooth devices** list and a trusted (“paired”) connection is established.

Pairing the RS507 Hands-Free Imager Using Android SSI

An RS507 Hands-free Imager can be used with the device to capture bar code data.

1. Ensure that the two devices are within 10 meters (32.8 feet) of one another.
2. Install the battery into the RS507.
3. On the MC92N0, touch .
4. Touch .

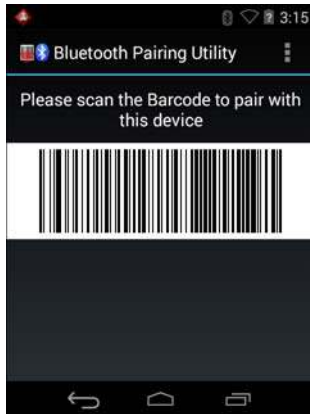



Figure 4-9 *Bluetooth Pairing Utility*

5. Using the RS507, scan the bar code on the screen.
The RS507 emits a high/low/high/low beeps. The Scan LED flashes green indicating that the RS507 is attempting to establish connection with the MC92N0. When connection is established, the Scan LED turns off and the RS507 emits one string of low/high beeps.
6. On the MC92N0, touch .

CHAPTER 5 USING BLUETOOTH ON WINDOWS DEVICES

Introduction

Bluetooth-equipped devices can communicate without wires, using frequency-hopping spread spectrum (FHSS) radio frequency (RF) to transmit and receive data in the 2.4 GHz Industry Scientific and Medical (ISM) band (802.15.1). Bluetooth wireless technology is specifically designed for short-range (32.8 feet/10 meters) communication and low power consumption.

MC92N0-Gs with Bluetooth capabilities can exchange information (e.g., files, appointments, and tasks) with other Bluetooth enabled devices such as phones, printers, access points, and other mobile computers.

The MC92N0-G with Bluetooth technology uses either the StoneStreet Bluetooth stack or the Microsoft Bluetooth stack. To write an application that uses the StoneStreet One Bluetooth stack APIs, refer to the Enterprise Mobility Developer Kit (EMDK) Help.

Adaptive Frequency Hopping

Adaptive Frequency Hopping (AFH) is a method of avoiding fixed frequency interferers, and can be used with Bluetooth voice. All devices in the piconet (Bluetooth network) must be AFH-capable in order for AFH to work. There is no AFH when connecting and discovering devices. Avoid making Bluetooth connections and discoveries during critical 802.11b communications. AFH for Bluetooth consists of four main sections:

- Channel Classification - A method of detecting an interference on a channel-by-channel basis, or pre-defined channel mask.
- Link Management - Coordinates and distributes the AFH information to the rest of the Bluetooth network.
- Hop Sequence Modification - Avoids interference by selectively reducing the number of hopping channels.
- Channel Maintenance - A method for periodically re-evaluating the channels.

When AFH is enabled, the Bluetooth radio “hops around” (instead of through) the 802.11b high-rate channels. AFH coexistence allows Zebra mobile computers to operate in any infrastructure.

The Bluetooth radio in this MC92N0-G operates as a Class 2 device power class. The maximum output power is 2.5mW and the expected range is 32.8 feet (10 meters). A definition of ranges based on power class is difficult to obtain due to power and device differences, and whether one measures open space or closed office space.



NOTE It is not recommended to perform Bluetooth wireless technology inquiry when high rate 802.11b operation is required.

Security

The current Bluetooth specification defines security at the link level. Application-level security is not specified. This allows application developers to define security mechanisms tailored to their specific need. Link-level security occurs between devices, not users, while application-level security can be implemented on a per-user basis. The Bluetooth specification defines security algorithms and procedures needed to authenticate devices, and if needed, encrypt the data flowing on the link between the devices. Device authentication is a mandatory feature of Bluetooth while link encryption is optional.

Pairing of Bluetooth devices is accomplished by creating an initialization key that is used to authenticate the devices and create a link key for them. Entering a common PIN number in the devices being paired generates the initialization key. The PIN number is never sent over the air. By default, the Bluetooth stack responds with no key when a key is requested (it is up to user to respond to the key request event). Authentication of Bluetooth devices is based-upon a challenge-response transaction. Bluetooth allows for a PIN number or passkey that is used to create other 128-bit keys used for security and encryption. The encryption key is derived from the link key used to authenticate the pairing devices. Also worthy of note is the limited range and fast frequency hopping of the Bluetooth radios that makes long-distance eavesdropping difficult.

Recommendations are:

- Perform pairing in a secure environment
- Keep PIN codes private and don't store the PIN codes in the MC92N0-G
- Implement application-level security.

The Microsoft stack supports Smart-pairing. For detailed information, refer to the Microsoft MSDN.

Security Mode 3 (Link Level Encryption)

The MC92N0-G supports Security Level 3 (Link Level Encryption). Link level encryption is the data security process of encrypting information at the data link level as it is transmitted between two devices.

Microsoft Bluetooth Stack

When pairing with a remote device using the Microsoft Bluetooth UI, Security Level 3 (Link Level Encryption) is automatically used. When developing applications using the Microsoft Bluetooth stack, enable Security Mode 3 using the *BthSetEncryption* API call. Refer to the Microsoft MSDN for more information.

StoneStreet One Bluetooth Stack

To set Security mode 3 on outgoing serial port connections, set **Encrypt Link On All Outgoing Connections** checkbox in the **Settings > Security** tab. See *Security on page 5-2* for more information.

Bluetooth Configuration

By default, the MC92N0-G is configured to using the Microsoft stack. Refer to the *MC92N0-G Integrator Guide*, for information on switching between the Microsoft Bluetooth stack and the StoneStreet One Bluetooth stack.

Table 5-1 list the services supported by the StoneStreet One Bluetooth stack and the Microsoft Bluetooth stack.

Table 5-1 *Bluetooth Services*

Microsoft Bluetooth Stack		StoneStreet One Bluetooth Stack	
Windows Handheld	WinCE	Windows Handheld	WinCE
Serial Port Service	Serial Port Service	Serial Port Service	Serial Port Service
Dial-Up Networking Client Service		Dial-Up Networking Client Service	Dial-Up Networking Client Service
OBEX Object Push Service		OBEX Object Push Client and Host Services	OBEX Object Push Client and Host Services
HID Client Service		HID Client Services	HID Client Services
A2DP/AVRCP Service		LAN Client Services	LAN Client Services
		Headset Audio Gateway Client Services	Headset Audio Gateway Services
Personal Area Networking Services		Personal Area Networking Services	Personal Area Networking Services
		File Transfer Client and Host Services	File Transfer Client and Host Services
		A2DP/AVRCP Services	

Table 5-2 list the COM ports available for the StoneStreet One Bluetooth stack and the Microsoft Bluetooth stack.

Table 5-2 *COM Ports*

Microsoft Bluetooth Stack	StoneStreet One Bluetooth Stack
COM5	COM5
COM9	COM9
	COM11
	COM21
	COM22
	COM23

Bluetooth Power States

Table [Table 5-3](#) list the state of the Bluetooth stacks after a warm or cold boot.

Table 5-3 *Bluetooth Power States*

After a	Windows Embedded Handheld Bluetooth Stack	Windows Embedded handheld Stone Street Bluetooth Stack	Windows CE Microsoft Bluetooth Stack	Windows CE Stone Street Bluetooth Stack
Warm Boot	Retains state	Retains state	Retains state	Retains state
Cold Boot	Retains state	Retains state	Does not retain state	Does not retain state

Suspend

When there is an active Bluetooth connection, the Bluetooth radio goes into low power mode maintaining the active connection. When there is no active connection, the Bluetooth radio turns off.

With StoneStreet One Bluetooth Stack

- ✓ **NOTE** If there is an active Bluetooth connection between the MC92N0-G and another Bluetooth device, the MC92N0-G will not timeout. However, if the user presses the Power button on the MC92N0-G, the MC92N0-G will suspend and upon receiving data from a remote Bluetooth device, the MC92N0-G will wake from suspend mode. For example, Bluetooth scanner sending data to the MC92N0-G.

With Microsoft Bluetooth Stack

- ✓ **NOTE** If there is an active Bluetooth connection between the MC92N0-G and another Bluetooth device and there is no data activity, the MC92N0-G will timeout. However, if the user presses the Power button on the MC92N0-G, the MC92N0-G will suspend and upon receiving data from a remote Bluetooth device, the MC92N0-G will wake from suspend mode. For example, headset redial or Bluetooth scanner sending data to the MC92N0-G.

Resume

When the MC92N0-G resumes, Bluetooth turns on if it was on prior to suspend.

- MotoBTUI Application
- Use the MotoBTUI application to:
 - Turn the Bluetooth radio on and off. See
 - View device information.
 - Control device status
 - Generate a pairing bar code (See Using the RS507 Hands-free Imager on page 10-19 for more information).
 - Configure FIPS key.

BTUI Window

Device Information

To view the MC92N0-G Bluetooth information:

1. On Windows Embedded devices, tap **Start > MotoBTUI** or on Windows CE devices, tap **Start > Programs > BTUI**.
2. Tap **My Device** Information.
3. The Device Information displays:
 - Device Name
 - HCI version number
 - LMP version number
 - Bluetooth chip manufacturer name
 - BT UI version number.
4. Tap the Back button to return to the **MotoBTUI** window.

FIPS Configuration

- ✓ **NOTE** By default the MC92N0-G has a FIPS key installed. If required, the user can generate a new FIPS key. If a new key is generated on the MC67, the same key is required to be used on the other Bluetooth device. The user must transfer the key to the other device.

To generate a new FIPS key automatically:

1. On Windows Embedded devices, tap **Start > MotoBTUI** or on Windows CE devices, tap **Start > Programs > MotoBTUI**.
2. Tap **FIPS Configuration**.
3. Tap **Generate Key** button.
4. Tap the **SetUp Key** button. A new key is generated. The key file, NewAESKey.reg, is created in the */Application* folder.
5. Tap the Back button to return to the **MotoBTUI** window.

To generate a new FIPS key manually:

1. On Windows Embedded devices, tap **Start > MotoBTUI** or on Windows CE devices, tap **Start > Programs > MotoBTUI**.
2. Tap **FIPS Configuration**.
3. Tap **Enter Key** button.
4. In the text box, enter a key.
5. Tap the **SetUp Key** button. A new key is generated. The key file, NewAESKey.reg, is created in the */Application* folder.
6. Tap the Back button to return to the **MotoBTUI** window.

To transfer the new FIPS key to another Bluetooth device:

1. Copy the NewAESKey.reg file from the MC92N0-G to the other Bluetooth device. Place the file into the */Application* folder.
2. Navigate to the */Application* folder.
3. Locate the NewAESKey.reg file and tap the filename. The **RegMerge** confirmation box displays.
4. Tap **Yes**.
5. Perform a warm boot.

Device Status

Use the **Device Status** option to set if the MC92N0-G would be seen by other Bluetooth devices. Touch the **Device Status** option to toggle the MC92N0-G from Hidden to Discoverable.

Using Microsoft Bluetooth Stack with Windows Embedded Handheld

The following sections provide information on using the Microsoft Bluetooth stack with the Windows Embedded Handheld operating system.

Turning the Bluetooth Radio Mode On and Off

Turn off the Bluetooth radio to save power or if entering an area with radio restrictions (e.g., an airplane). When the radio is off, other Bluetooth devices cannot see or connect to the MC92N0-G. Turn on the Bluetooth radio to exchange information with other Bluetooth devices (within range). Communicate only with Bluetooth radios in close proximity.



NOTE To achieve the best battery life turn off radios not in use.

Enabling Bluetooth

To enable Bluetooth:

1. Tap **Wireless Manager** and then tap the **Bluetooth** bar or
Tap **Start > Setting > Connections > Bluetooth** icon > **Mode** tab.
2. Check the **Turn On Bluetooth** checkbox.
3. Tap **ok**.

Disabling Bluetooth

To disable Bluetooth:

1. Tap **Wireless Manager** and then tap the **Bluetooth** bar or
Tap **Start > Setting > Connections > Bluetooth** icon > **Mode** tab.
2. Un-check the **Turn On Bluetooth** checkbox.
3. Tap **ok**.

Discovering Bluetooth Device(s)

The MC92N0-G can receive information from discovered devices without bonding. However, once bonded, the MC92N0-G and a bonded device exchange information automatically when you turn the Bluetooth radio on. See *Pairing with Discovered Device(s) on page 5-29* for more information.

To find Bluetooth devices in the area:

1. Ensure that Bluetooth is enabled on both devices.
2. Ensure that the Bluetooth device to discover is in discoverable and connectable modes.
3. Ensure that the two devices are within 30 feet (10 meters) of one another.
4. Tap **Start > Settings > Connections** tab > **Bluetooth** icon > **Devices** tab.
5. Tap **Add new device**. The MC92N0-G begins searching for discoverable Bluetooth devices in the area.
6. Select a device from the list.
7. Tap **Next**.

✓ **NOTE** If Smart-pairing is configured and the device is requesting one of the pre-defined PINs, the **Enter Passcode** window does not appear.

8. Enter the Passcode on the other device. The device is added to the Bluetooth list.

You are prompted to enter a passcode. If the device has a specific passcode, enter it in the Passcode field and tap Next. If the device does not have a specific passcode, enter one in the Passcode field and tap Next. The Bluetooth radio tries to connect with the device.

9. If you created a passcode, you will be prompted by the other device to enter the same passcode. Enter the created passcode to establish a paired connection. (If you entered a passcode from the device, you shouldn't have to do anything on the other device.)

10. When the connection is complete, a list of matching and supported services on the device appears.

11. Select the services you want to use and tap Finish. The services on the new devices have to be selected or else the pairing won't include those services, even though the devices are paired. If services are not selected, you will be continually reprompted for the passcode from the device.

12. The device appears in the list on the main window.

After the passcodes have been accepted on both sides, you have a trusted ("paired") connection.

Available Services

✓ **NOTE** Some devices might not require a PIN. This depends upon the device's authentication.

The MC92N0-G with Microsoft Bluetooth stack and Windows Embedded Handheld offers the following services:

- OBEX Object Push via Beam
- Serial Port
- Personal Area Networking
- HID
- Dial-up Networking
- A2DP/AVRCP.

See the following sections for information on these services.

Object Push Services via Beam

✓ **NOTE** You can only send files to a remote device using the Beam function.

Use the OBEX Push Service to send files and contacts to another Bluetooth device. To transfer files between the MC92N0-G and another Bluetooth enabled device:

1. Ensure that Bluetooth is enabled and discoverable on both devices.
2. Ensure that the two devices are within 30 feet (10 meters) of one another.
3. Tap **Start > Programs > File Explorer**.
4. Navigate to the file to transfer.
5. Tap and hold on the filename until the pop-up menu appears.



Figure 5-1 File Explorer Window

6. Select **Beam File**. The MC92N0-G searches for Bluetooth devices in the area.
7. Tap **Tap to send** next to the Bluetooth device to send the file to. The MC92N0-G communicates with the device and send the file. When completed, **Tap to send** changes to **Done**.

To transfer a contact between the MC92N0-G and another Bluetooth enabled device:

1. Ensure that Bluetooth is enabled and discoverable on both devices.
2. Ensure that the two devices are within 30 feet (10 meters) of one another.
3. Tap **Start > Contacts**
4. Navigate to the contact to transfer.
5. Tap and hold on the contact until the pop-up menu appears.
6. Select **Send Contact > Beam**. The MC92N0-G searches for Bluetooth devices in the area.
7. Tap **Tap to send** next to the Bluetooth device to send the file to. The MC92N0-G communicates with the device and send the contact. When completed, **Tap to send** changes to **Done**.

Serial Port Services

Use the wireless Bluetooth serial port connection as you would a physical serial cable connection. Configure the application that will use the connection to the correct serial port.

To establish a serial port connection:

1. Ensure that Bluetooth is enabled and discoverable on both devices.
2. Ensure that the two devices are within 30 feet (10 meters) of one another.
3. Tap **Start > Programs > BTScannerCtlPanel**.
4. Select the **BT Scanner** checkbox and then select the appropriate Com port from the drop-down list.
5. Tap **Save and Exit**.
6. Tap **Start > Settings > Connections tab > Bluetooth icon > Devices** tab.
7. Tap **Add new device**. The MC92N0-G begins searching for discoverable Bluetooth devices in the area.
8. Select a device from the list.
9. Tap **Next**.

✓ **NOTE** If Smart-pairing is configured and the device is requesting one of the pre-defined PINs, the **Enter Passcode** window does not appear.

10. Enter the Passcode and the tap **Next**. The device is added to the Bluetooth list.

11. In the device list, tap the serial device. The **Partnership Settings** window displays.
12. Select the **Serial Port** checkbox.
13. Tap **Save**.
14. Tap **COM Ports** tab.
15. Tap **New Outgoing Port**.
16. Select the serial device in the list and then tap **Next**.
17. Select a COM port from the drop-down list.
18. Tap **Finish**.

✓ **NOTE** No connection is made at this point. An application must open the selected COM port to trigger Microsoft Bluetooth stack to open the connection.

ActiveSync Using Serial Port Services

Use the wireless Bluetooth serial port connection for ActiveSync just as you would a physical serial cable connection. You must configure the application that will use the connection to the correct serial port.

To set up a Bluetooth ActiveSync connection:

Before setting up a Bluetooth ActiveSync connection, configure the Bluetooth function of your device.

✓ **NOTE** For additional security, disable network bridging on the computer (specifically, bridging to a Remote NDIS adapter) before connecting to the computer to pass through to the Internet or a network. For more information on network bridging, see **Windows Help** on your computer.

The instructions below are for computers that support the Windows XP SP2 or later version operating system.

1. Ensure that Bluetooth is enabled and discoverable on both devices.
2. Ensure that the two devices are within 32.8 feet (10 meters) of one another.
3. On the computer, click **Start > Settings > Control Panel**.
4. Double-click **Bluetooth Devices**.
5. On the **Options** tab, select the **Turn discovery on** and **Allow Bluetooth devices to connect to this computer** checkboxes.

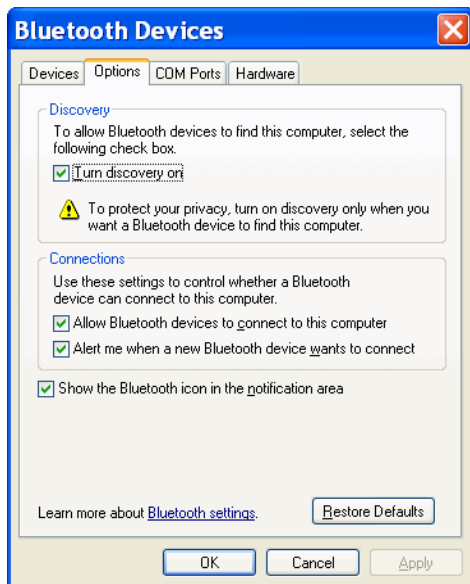

Figure 5-2 Computer Bluetooth Devices Window

6. On the **COM Ports** tab, click **Add**.
7. Select the **Incoming (device initiates the connection)** option, then click **OK**.
Note the number of the COM port that was added.
8. Click **OK**.
9. Click **Start > All Programs > Microsoft ActiveSync**.
10. Click **File > Connection Settings**.
11. On the **Allow connections to one of the following** drop-down list, select the COM port with the number you noted earlier.
12. On the MC92N0-G, tap **Start > Programs > ActiveSync**.
13. Tap **Menu > Connect via Bluetooth**.
Synchronization is automatically initiated. The **ActiveSync** icon appears on the lower right corner of the **Today** screen.
If an Authentication is required, the **Enter Passcode** screen appears, type an alphanumeric passkey (PIN code), then tap **Next**; enter the same passkey on the other device.
The passkey is recommended for enhanced security. Your passkey must be between 1 to 16 alphanumeric characters.
If you do not want to use a passkey, tap **Next**.
14. To disconnect the ActiveSync connection, tap the **ActiveSync** icon on the Today screen.
15. Tap **Disconnect**.

Using Microsoft Bluetooth Stack with Windows CE

The following sections provide information on using the Microsoft Bluetooth stack with Windows CE operating system.

Power Modes

The Bluetooth radio switches between normal and low power modes automatically. When data transfer is required, the radio goes into normal mode. After five seconds of inactivity, the radio goes into low power mode.

Discovering Bluetooth Device(s)

The MC92N0-G can receive information from discovered devices without bonding. However, once bonded, the MC92N0-G and a bonded device exchange information automatically when you turn the Bluetooth radio on. See *Pairing with Discovered Device(s)* on page 5-29 for more information.

To find Bluetooth devices in the area:

1. Ensure that Bluetooth is enabled on both devices.
2. Ensure that the Bluetooth device to discover is in discoverable and connectable modes.
3. Ensure that the two devices are within 30 feet (10 meters) of one another.
4. Tap **Start > Settings > Control Panel > Bluetooth Device Properties** icon.



Figure 5-3 *Bluetooth Manager*

5. Tap **Scan Device** button. The MC92N0-G begins searching for discoverable Bluetooth devices in the area. Discovered devices appear in the list.
6. Double-tap a device from the list. A pop-up menu appears.
7. Tap **Trusted**.
8. Tap **Yes**.
9. Enter a PIN and then tap **OK**.
10. Enter the PIN on the other device.

You are prompted to enter a PIN. If the device has a specific PIN, enter it in the PIN field and tap **Next**. If the device does not have a specific PIN, enter one in the PIN field and tap **Next**.

11. The device appears in the list on the main window with a key next to it.

After the PIN has been accepted on both sides, a trusted (“paired”) connection is created.

✓ **NOTE** Some devices might not require a PIN. This depends upon the device’s authentication.

Available Services

✓ **NOTE** In order to connect to the Bluetooth device, the application must create the connection to the remote device. Please refer to the MSDN Help for detailed information.

The MC92N0-G with Microsoft Bluetooth stack and Windows CE only supports the Serial Port service.

Using Bluetooth StoneStreet One Bluetooth Stack

The following sections provide information on using the Stone Street One Bluetooth stack.

Turning the Bluetooth Radio Mode On and Off

Turn off the Bluetooth radio to save power or if entering an area with radio restrictions (e.g., an airplane). When the radio is off, other Bluetooth devices cannot see or connect to the MC92N0-G. Turn on the Bluetooth radio to exchange information with other Bluetooth devices (within range). Communicate only with Bluetooth radios in close proximity.

✓ **NOTE** To achieve the best battery life turn off radios not in use.

Disabling Bluetooth (Windows CE)

To disable Bluetooth, tap **Bluetooth** icon > **Disable Bluetooth**. The **Bluetooth** icon changes to indicate that Bluetooth is disabled.

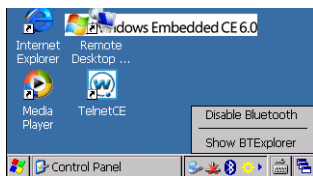

Figure 5-4 *Disable Bluetooth*

Enabling Bluetooth (Windows CE)

To enable Bluetooth, tap **Bluetooth** icon > **Enable Bluetooth**. The **Bluetooth** icon changes to indicate that Bluetooth is enabled.

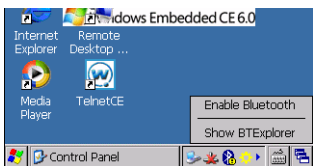

Figure 5-5 *Enable Bluetooth*

Disabling Bluetooth (Windows Embedded Handheld)

To disable Bluetooth, tap **Start** > **Settings** > **Connections** > **Wireless Manager**. Tap the **Bluetooth** bar to disable Bluetooth.

Enabling Bluetooth (Windows Embedded Handheld)

To enable Bluetooth, tap **Start** > **Settings** > **Connections** > **Wireless Manager**. Tap the **Bluetooth** bar to enable Bluetooth.

Modes

The BTE Explorer application has two modes for managing Bluetooth connections: Wizard Mode and Explorer Mode. The Wizard Mode is for novice Bluetooth users and the Explorer Mode is for experienced Bluetooth users. To switch between modes, select **View > Wizard Mode** or **View > Explorer Mode**.

Wizard Mode

Wizard Mode provides a simple process for discovering and connecting to Bluetooth devices.

✓ **NOTE** Switching between Wizard Mode and Explorer Mode closes all active connections.

Wizard Mode shows the devices and services in a simple Favorites view created by following the step-by-step wizard.

Explorer Mode

The **Explorer Mode** window is easy to navigate and provides greater control to users familiar with Bluetooth. The menu bar provides quick access to the options and tools used to connect to devices. To access Explorer Mode, tap **View > Explorer Mode**.

Also use the “tap and hold” technique to view available options. Scroll bars and view options are similar to those on the Windows desktop. The tree structure lists the following sub-items:

- Local Device - This device
- Remote Device - Other Bluetooth devices
 - Trusted Devices - Bonded (paired) Bluetooth devices
 - Untrusted Devices - Discovered devices that are not bonded
- Favorites - Selected services that are set as *Favorite* for quick access.

✓ **NOTE** Switching between Wizard Mode and Explorer Mode closes all active connections.

Discovering Bluetooth Device(s)

The MC92N0-G can receive information from discovered devices without bonding. However, once bonded, the MC92N0-G and a bonded device exchange information automatically when you turn the Bluetooth radio on. See *Pairing with Discovered Device(s) on page 5-29* for more information.

To find Bluetooth devices in the area:

1. Ensure that Bluetooth is enabled on both devices.
2. Ensure that the Bluetooth device to discover is in discoverable and connectable modes.
3. Ensure that the require profile is enabled on the MC92N0-G. See *Profiles Tab on page 5-36* for more information.
4. Ensure that the two devices are within 30 feet (10 meters) of one another.
5. Tap the **Bluetooth** icon and select **Show BTE Explorer**.

✓ **NOTE** If favorite connections have already been created, the **Favorites** screen displays. If no favorite connections have been created, the **New Connection Wizard** screen displays.

6. Tap **Menu > New Connection**. The **New Connection Wizard** appears.



Figure 5-6 *BTExplorer Window*

7. Select **Explore Services on Remote Device** or another from the drop-down list and tap **Next**.

✓ **NOTE** If a device discovery action has not been previously performed, a device discovery is automatically initiated. If a device discovery has previously been performed, the device discovery process is skipped, and the previously found list of devices displays. To start a new device discovery, tap and hold in the window and select **Discover Devices** from the pop-up menu.

8. **BTExplorer** searches for Bluetooth devices in the area.



Figure 5-7 *Discover Devices Dialog Box*

The discovered devices display in the **Select Remote Device** window.

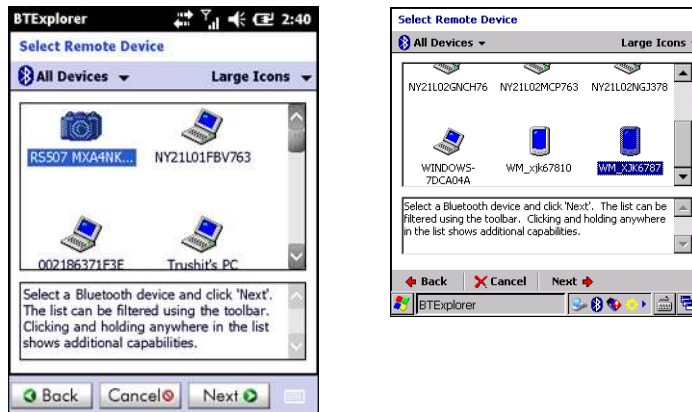

Figure 5-8 Select Remote Device Window

9. Select a device from the list and tap **Next**. The MC92N0-G searches for services on the selected Bluetooth device.



Figure 5-9 Device Services

✓ **NOTE** If the MC92N0-G discovers a service but the service is not supported, the service icon is grayed-out.

10. Select a service from the list and press **Next**.



Figure 5-10 Connection Favorite Options Window

11. In the **Favorite Name** text box, enter a name for this service that will appear in the **Favorite** window. and then tap **Next**.
12. Tap **Connect** to add the service to the **Favorite** window and connect to the service.



Figure 5-11 Favorites Window

Available Services

- ✓ **NOTE** Some devices might not require a PIN. This depends upon the device's authentication.

See the following sections for information on these services.

File Transfer Services

- ✓ **NOTE** Shared folders are a security risk.

To transfer files between the MC92N0-G and another Bluetooth enabled device:

1. Ensure that OBEX File Transfer profile is enabled on the MC92N0-G. See *Profiles Tab on page 5-36* for more information.

- ✓ **NOTE** If favorite connections have already been created, the **Favorites** screen displays. If no favorite connections have been created, the **New Connection Wizard** screen displays.

2. Use the **Connection Wizard** to search for a Bluetooth device.
3. Select the device and tap **Next**. The **Select Remote Service** window appears.
4. Select **File Transfer** and tap **Next**. The **Connection Favorite Options** window appears.
5. Tap **Next**. The **Connection Summary** window appears.
6. Tap **Connect**. The remote device's accessible folders appear.

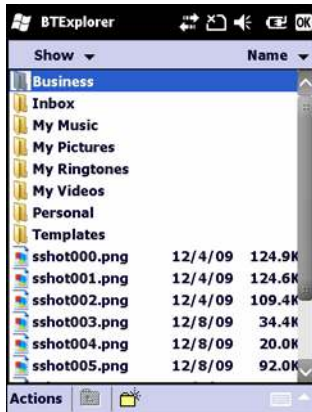

Figure 5-12 File Transfer Window

7. Double-tap the file to copy. The **Save Remote File** window appears.

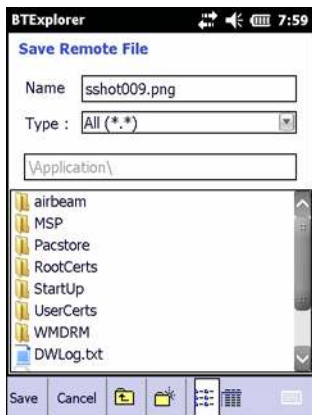

Figure 5-13 Save Remote File Window

8. Tap and hold on the file. A pop-up menu appears.
9. Select the action to perform:
 - **New**- create a new file or folder on the remote device
 - **Delete**- delete the selected file on the remote device.
 - **Get File**- copy the file from the remote device to the MC92N0-G.
 - **Put File**- copy a file from the MC92N0-G to the remote device.

Creating a New File or Folder

To create a new folder or file on the remote device:

1. Tap and hold on the screen and select **New > Folder** or **New > File**. The **Create New Folder** or **Create New File** window appears.
2. Enter the name for the new folder or file.
3. Tap **OK** to create the new folder or file on the remote device.

Deleting a File

To delete a file from the remote device:

1. Tap and hold on the file to delete and select **Delete**.
2. In the **Delete Remote Device File** dialog box tap **Yes**.

Getting a File

To copy a file from a remote device:

1. Double-tap or tap and hold on the file and select **Get**.
2. Navigate to the directory to save the file.
3. Tap **Save**. The file is transferred from the remote device to the MC92N0-G.

Copying a File

To copy a file to a remote device:

1. Tap **Action > Put**.
2. Navigate to the directory to save the file and select a file.
3. Tap **Open**. The file copies from the MC92N0-G to the remote device.

Connecting to the Internet Using an Access Point

This section explains how to access a Bluetooth-enabled LAN access point (AP) for a network connection. Use Internet Explorer to connect to a server.

1. Ensure the MC92N0-G is discoverable and connectable. See *Device Info Tab on page 5-31*.
2. Ensure that the **Personal Area Networking** profile is enabled on the MC92N0-G. See *Profiles Tab on page 5-36* for more information.
3. Use the **Connection Wizard** to search for a Bluetooth AP.

✓ **NOTE** If favorite connections have already been created, the **Favorites** screen displays. If no favorite connections have been created, the **New Connection Wizard** screen displays.

4. Select the **Personal Area Network** or **Network Access** service and select **Connect** from the pop-up menu. The MC92N0-G connects with the access point.
5. Tap  > **Internet Explorer**.
6. In the address field, enter an internet address and tap the **Enter** button. The web page loads.

✓ **NOTE** Network Access profile is not supported.

Dial-Up Networking Services

Dial-up networking allows the user to connect the MC92N0-G to a Bluetooth Phone and use the Bluetooth Phone as a modem to connect to an office network or ISP.

Before setting up dial-up networking, obtain dial-up information and other necessary settings (username, password and domain name, if required) for the office network or ISP.

To create a new Bluetooth connection:

1. Ensure the Bluetooth Phone is discoverable and connectable.

2. Ensure that the **Dial-Up Networking** profile is enabled on the MC92N0-G. See *Profiles Tab* on page 5-36 for more information.
3. Tap **Menu > New Connection**.
4. Select **Explore Services on Remote Device** or another from the drop-down list and tap **Next**.
5. **BTE Explorer** searches for Bluetooth devices in the area.

The discovered devices display in the **Select Remote Device** window.

6. Select the Bluetooth Phone from the list and tap **Next**. The MC92N0-G searches for services on the Bluetooth Phone.

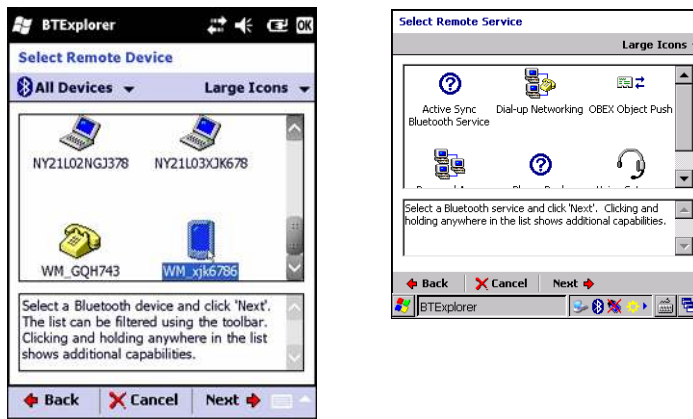

Figure 5-14 Select Remote Service Window

7. Select **Dial-up Networking Gateway** service from the list and tap **Next**. The **Connection Favorite Options** window appears.



Figure 5-15 Connection Favorite Options Window

8. In the **Favorite Name** text box, enter a name for this service that will appear in the **Favorite** window.
9. Tap **Next**. The **Connection Summary** window appears.
10. Tap **Connect**. The **Select Dial-up Networking Entry** window appears.



Figure 5-16 Select Dial-up Networking Entry Window

11. Select the entry and tap **OK**. The MC92N0-G begins to communicate with the Bluetooth phone. If required, the phone requests permission to communicate with the MC92N0-G.
12. Confirm the connection on the phone.
13. In the **User name** text box, enter the user name for this connection.
14. In the **Password** text box, enter the password for this connection.
15. In the **Domain** text box, enter the domain name for this connection, if required.
16. Tap **Finish** or **Connect**.
17. The phone begins dialing and connects to the network.
18. To end a session, tap the **Connection** icon and then tap **Disconnect** in the dialog box.

Add a Dial-up Entry

To add a dial-up entry:

1. In the **Select Dial-up Networking Entry** window, tap and hold and then select **Add Entry** from the pop-up menu.



Figure 5-17 Select Dial-up Networking Entry Window

2. The **Add Phone Book Entry** window appears.

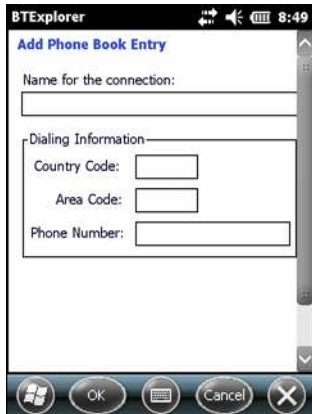

Figure 5-18 Add Phone Book Entry Window

3. In the **Name for the connection** text box, enter a name for this connection.
4. In the **Country Code** text box, enter the country code for the country that you are calling.
5. In the **Area Code** text box, enter the area code.
6. In the **Phone Number** text box, enter the phone number.
7. Tap **OK**.

Object Exchange Push Services

Object Exchange (OBEX) is a set of protocols that allows sharing objects such as Contacts or pictures using Bluetooth.

To exchange contact information with another Bluetooth enabled device:

1. Ensure the MC92N0-G is discoverable and connectable. See *Device Info Tab on page 5-31*.
2. Ensure that the **OBEX Object Push** profile is enabled on the MC92N0-G. See *Profiles Tab on page 5-36* for more information.

✓ **NOTE** If favorite connections have already been created, the **Favorites** screen displays. If no favorite connections have been created, the **New Connection Wizard** screen displays.

3. Use the **Connection Wizard** to search for a Bluetooth device.
4. Select the device and tap **Next**.
5. Select the **OBEX Object Push** service and select **Next**.
6. Tap **Next**. The **Connection Summary** window appears.
7. Tap **Connect**. The **OBEX Object Push** window appears.
8. In the **Action** drop-down list, select one of the following options: **Send Contact Information**, **Swap Contact Information**, **Fetch Contact Information**, or **Send a Picture**.

Sending a Contact

To send a contact to another device:

✓ **NOTE** Prior to sending and receiving contacts, a default contact must be set up before attempting to send a contact.

1. Tap and hold on **OBEX Object Push** and select **Connect**.



Figure 5-19 OBEX Object Push Window

2. In the **Action:** drop-down list, select **Send Contact Information**.
3. Tap .
4. Select a contact to send to the other device.
5. Tap **OK**.
6. Tap **OK** to send the contact to the other device and display a confirmation dialog box on the other device to accept the contact. A **Send Contact** dialog appears.
7. Tap **Ok**.

Swapping Contacts

To swap contacts with another device:

- ✓ **NOTE** Prior to swapping contacts, a default contact must be set up before attempting to send a contact.

Ensure that the MC92N0-G is connectable.

1. Tap and hold on **OBEX Object Push** and select **Connect**. The **OBEX Object Push** window appears.



Figure 5-20 OBEX Object Push Window

2. In the **Action:** drop-down list, select **Swap Contact Information**.
3. Tap .

4. Select a contact to send to the other device.
5. Tap **OK**.
6. Tap **OK** to swap contacts with the other device and display a confirmation dialog box on the other device to accept the contact.
7. Tap **Ok**.

Fetching a Contact

To fetch a contact from another device:

✓ **NOTE** Prior to sending and receiving contacts, a default contact must be set up before attempting to send a contact.

Ensure that the MC92N0-G is connectable.

1. Tap and hold on **OBEX Object Push** and select **Connect**. The **OBEX Object Push** window appears.



Figure 5-21 *OBEX Object Push Window*

2. In the **Action:** drop-down list, select **Fetch Contact information**.
3. Tap **OK**. The contact on the other device is copied.

Sending a Picture

To send a picture to another device:

1. Tap and hold on **OBEX Object Push** and select **Connect**. The **OBEX Object Push** window appears.



Figure 5-22 OBEX Object Push Window

2. In the **Action:** drop-down list, select **Send A Picture**.
3. Tap . The **Send Local Picture** window appears.

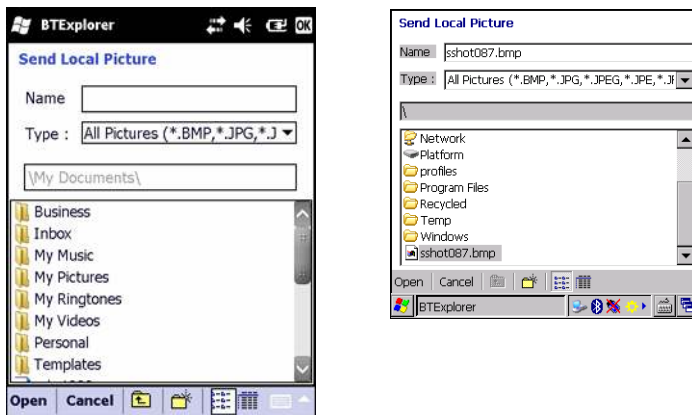

Figure 5-23 Send Local Picture Window

4. Navigate to the picture to send to the other device.
5. Tap **Open**.
6. Tap **OK** to send the picture to the other device and display a confirmation dialog box on the other device to accept the picture. A **Send Picture** dialog appears.
7. Tap **Ok**.

Headset Services

To connect to a Bluetooth headset:



NOTE Newer Bluetooth headsets are device dependant and remember the last device they connected to. If problems occur while connecting to the headset, place the headset in discovery mode. Refer to the headset user manual for more information.

1. Ensure the MC92N0-G is connectable (required when automatic re-connect is initiated). See *Device Info Tab on page 5-31*.
2. Ensure that the **Headset** profile is enabled on the MC92N0-G. See *Profiles Tab on page 5-36* for more information.

3. Use the **Connection Wizard** to search for a Bluetooth headset.
4. Select the device and tap **Next**.
5. Select the **Headset** service name and select **Connect**. The MC92N0-G connects to the headset. Refer to the headset user manual for instructions on communicating with a Bluetooth device.

✓ **NOTE** When using a Bluetooth headset with Headset Services, you cannot accept or end a call from the headset. You must accept or end a call on the MC92N0-G.

6. Press the communication button on the headset. This routes system audio to the headset.
7. Press the communication button on the headset to route the audio back to the MC92N0-G.

Serial Port Services

Use the wireless Bluetooth serial port connection as you would a physical serial cable connection. Configure the application that will use the connection to the correct serial port.

To establish a serial port connection:

1. Use the **Connection Wizard** to search for a Bluetooth serial device.
2. Select the device and tap **Next**. The **Connection Favorite Options** window appears.
3. In the **Local COM Port:** drop-down list select a COM port.
4. Tap **Finish**.

ActiveSync Using Serial Port Services

✓ **NOTE** By default, COM ports COM5, COM9, COM11, COM21, COM22 and COM23 are Bluetooth virtual ports. If an application opens one of these ports, the Bluetooth driver activates and guides you through a Bluetooth connection.

Use the wireless Bluetooth serial port connection for ActiveSync just as you would a physical serial cable connection. You must configure the application that will use the connection to the correct serial port.



Figure 5-24 ActiveSync Connection Settings Window on PC

To establish an ActiveSync connection:

✓ **NOTE** When creating an ActiveSync connection, only use StoneStreet One Bluetooth Explorer in Wizard mode.

1. Use the **Connection Wizard** to search for a Bluetooth device, such as a PC. In the drop-down list select **ActiveSync via Bluetooth**.
2. Select the device and tap **Next**. The **Connection Favorite Options** window appears.
3. Tap **Connect**. The **Remote Service Connection** window appears.

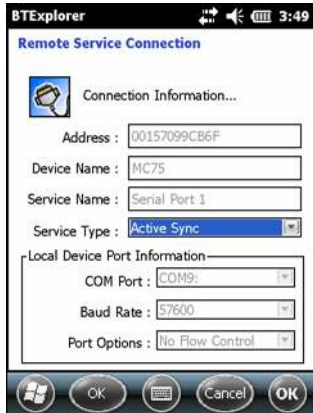

Figure 5-25 Remote Service Connection Window

4. In the **Service Type** drop-down list, select **Active Sync**.
5. Tap **OK**. The MC92N0-G connects the PC and an ActiveSync session begins.
6. Tap **Finish**. The **Connection Favorite Options** window appears.
7. To end the session, tap the ActiveSync icon in the **Favorite** window and select **Disconnect** from the pop-up window.

Personal Area Network Services

✓ **NOTE** This profile supports Ad-hoc and PAN User. Network Access Profile is not supported.

Connect two or more Bluetooth devices to share files, collaborate, or play multi-player games. To establish a Personal Area Network connection:

1. Ensure that the **Personal Area Networking** profile is enabled on the MC92N0-G. See *Profiles Tab on page 5-36* for more information.
2. Use the **Connection Wizard** to search for a Bluetooth device.
3. Select the device and tap **Next**. The **Connection Favorite Options** window appears.
4. Tap **Next**. The **Connection Summary** window appears.
5. Tap **Connect**. The MC92N0-G connects to the Bluetooth device.

A2DP/AVRCP Services

A2DP/AVRCP is used to connect to a high-quality stereo headset:

1. Ensure the MC92N0-G is connectable (required when automatic re-connect is initiated). See *Device Info Tab on page 5-31*.
2. Ensure that the remote Bluetooth device is in discoverable mode. See the devices user manual for instructions.
3. Ensure that the **A2DP/AVRCP** profile is enabled on the MC92N0-G. See *Profiles Tab on page 5-36* for more information.

4. Tap **Menu > Settings > Services** tab.
5. Tap **Add** button.
6. Select **Advanced Audio Distribution Services**.
7. Tap **OK three times**.
8. Tap **Menu > New Connection**.
9. Select **Connect to High-Quality Audio** from the drop-down list.
10. Tap **Next**.
11. Select the device and tap **Next**.
12. Enter the PIN Code for the remote device and then tap **OK**.
13. Tap **Next**.
14. Tap **Connect**. The MC92N0-G connects to the high-quality audio headset.

Connect to a HID Device

The MC92N0-G can connect to an Human Interface Device (HID) device such as a Bluetooth keyboard:

1. Ensure the MC92N0-G is connectable (required when automatic re-connect is initiated). See *Device Info Tab on page 5-31*.
2. Ensure that the remote Bluetooth device is in discoverable mode. See the device user manual for instructions.
3. Ensure that the **HID Client** profile is enabled on the MC92N0-G. See *Profiles Tab on page 5-36* for more information.
4. Tap **Menu > New Connection**.
5. Select **Explore Services on Remote Device** from the drop-down list.
6. Tap **Next**.
7. Select the device and tap **Next**.
8. Select the service and tap **Next**.
9. Tap **Next**.
10. Tap **Connect**. The MC92N0-G connects to the HID device.

Pairing with Discovered Device(s)

Pairing is a relationship created between the MC92N0-G and another Bluetooth device in order to exchange information in a secure manner. Pairing involves entering the same PIN on the two devices. After pairing and turning on the Bluetooth radios, the devices recognize the pairing and can exchange information without re-entering a PIN.

To pair with a discovered Bluetooth device:

✓ **NOTE** If favorite connections have already been created, the **Favorites** screen displays. If no favorite connections have been created, the **New Connection Wizard** screen displays.

1. Tap the **Bluetooth** icon and select **Show BTE Explorer**. The **BTE Explorer** window appears.
2. Tap **Menu > New Connection**. The **New Connection Wizard** window appears.
3. In the drop-down list, select **Pair with Remote Device**.
4. Tap **Next**. The **Select Remote Device** window appears.



NOTE Devices discovered previously are listed to save time. To start a new device discovery, tap and hold on the list area and select **Discover Devices** from the pop-up menu.



Figure 5-26 Select Remote Device Window

5. Select a device from the list and tap **Next**. The **PIN Code Request** window appears.



Figure 5-27 PIN Request Window

6. In the **PIN Code** field, enter the PIN code.

7. Tap **OK**. The **Pairing Status** window displays.

8. Tap **Finish**. The devices are successfully paired. The device name moves to the **Trusted Devices** window.

Deleting a Paired Device

To delete a device no longer needed:

1. Tap the **Bluetooth** icon and select **Show BTE Explorer**. The **BTE Explorer** window appears.

2. Tap **Menu > Trusted Devices**. The **Trusted Devices** window appears.

3. Tap and hold on the device select **Delete Link Key** in the pop-up menu.

4. A confirmation dialog appears. Tap **Yes**.

Accepting a Pairing

When a remote device wants to pair with the MC92N0-G, enter a PIN when requested to grant permission.

1. Ensure that the MC92N0-G is set to discoverable and connectable. See *Bluetooth Settings* on page 5-31. When prompted to pair with the remote device the **PIN Code Request** window appears.



Figure 5-28 PIN Code Request Window

2. In the **PIN Code:** text box, enter the same PIN entered on the device requesting the pairing. The PIN must be between 1 and 16 characters.
3. In the **Device Name:** text box, edit the name of the device requesting the pairing, if desired.
4. Tap **OK** to create the pairing. The MC92N0-G can now exchange information with the other device.

Bluetooth Settings

Use the **BTExplorer Settings** window to configure the operation of the **BTExplorer** application. Tap **Menu > Settings**.

Device Info Tab

Use the **Device Info** tab to configure the MC92N0-G's Bluetooth connection modes.

- **Device Name-** Displays the name of the MC92N0-G.
- **Discoverable Mode-** Select whether or not the MC92N0-G is discoverable by other Bluetooth devices.
- **Connectable Mode-** Select whether or not the MC92N0-G is connectable by other Bluetooth devices.

Services Tab

- ✓ **NOTE** Ensure that the MC92N0-G is discoverable and connectable when remote devices use MC92N0-G services.

Use the **Services** tab to add or delete Bluetooth services.

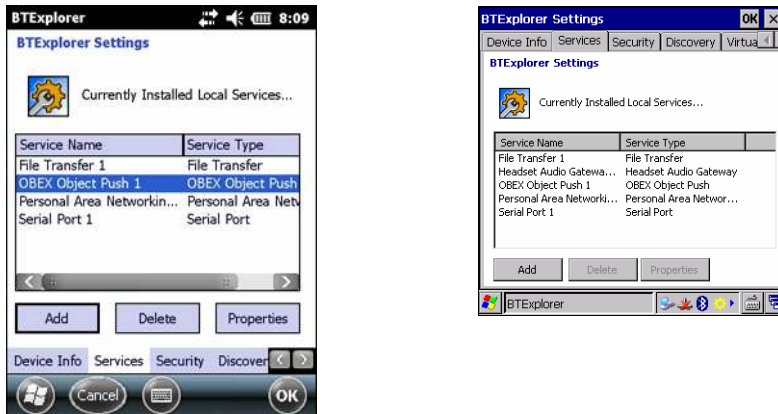

Figure 5-29 BTE Explorer Settings - Services Tab

To add a service:

1. Tap **Add**. The **Add Local Service** window displays.



Figure 5-30 Add Local Service Window

2. In the list, select a service to add.
3. Tap **OK**. The **Edit Local Service** window displays for the selected service.
4. Select the appropriate information and then tap **OK**. See the following sections for information on the available services.

Dial-Up Networking Service

Dial-up Networking allows other Bluetooth devices to access a dial-up modem.

- **Service Name**- Displays the name of the service.
- **Service Security**- Select the type of security from the drop-down list. Options are **None**, **Authenticate**, or **Authenticate/Encrypt**.
- **Local COM Port**- Select the COM port.
- **Local Baud Rate**- Select the communication baud rate.
- **Local Port Options**- Select the port option.

File Transfer Service

File transfer allows other Bluetooth devices to browse files.



Figure 5-31 *BTE Explorer Settings - File Transfer Information*

- **Service Name**- Displays the name of the service.
- **Service Security**- Select the type of security from the drop-down list. Options are **None**, **Authenticate**, or **Authenticate/Encrypt**.
- **Root Directory**- Select the directory that other Bluetooth devices can access.
- **File Permissions**- Select the file permissions for the selected directory. Check the appropriate box to grant read access, write access, and delete access.

Headset Audio Gateway Service

Headset Service Audio Gateway allows connection to headset devices.

- **Service Name**- Lists the name of the audio service.

OBEX Object Push Service

OBEX Object Push allows other Bluetooth devices to push contacts, business cards, pictures, appointments, and tasks to the MC92N0-G.

- **Service Name**- Displays the name of the service.
- **Service Security**- Select the type of security from the drop-down list. Options are **None**, **Authenticate**, or **Authenticate/Encrypt**.
- **Do not allow clients to push objects**- Disables clients from pushing objects to the MC92N0-G.
- **Inbox Directory**- Select a directory where another Bluetooth device can store files.

Personal Area Networking Service

Personal Area Networking hosts a Personal Area Network which allows communication with other Bluetooth devices.

- **Service Name**- Displays the name of the service.
- **Service Security**- Select the type of security from the drop-down list. Options are **None**, **Authenticate**, or **Authenticate/Encrypt**.
- **Support Group Ad-Hoc Networking**- Select to enable Ad-Hoc networking.

Serial Port Service

Serial port allows other Bluetooth devices to access COM ports.

- **Service Name**- Displays the name of the service.
- **Service Security**- Select the type of security from the drop-down list. Options are **None**, **Authenticate**, or **Authenticate/Encrypt**.
- **Local COM Port**- Select the COM port.
- **Local Baud Rate**- Select the communication baud rate.
- **Local Port Options**- Select the port option.

Advanced Audio Distribution Service

Advanced Audio Distribution hosts connects from Bluetooth devices supporting high-quality stereo audio.

- **Service Name**- Lists the name of the audio service.

Audio Video Remote Control Service

Audio Video Remote Control hosts connections from Bluetooth devices supporting audio remote-control functionality.

- **Service Name**- Lists the name of the audio service.

Security Tab

Security settings allows you to set global security policies for Bluetooth. Note that these settings are only active on local Services that are set to Authenticate or Authenticate/Encryption. You can set authentication on local Services under the Services tab.

To adjust the security settings for an individual service, select the **Services** tab first, then select the individual service, then **Properties**.



Figure 5-32 BTE Explorer Settings - Security



NOTE To use PIN Code, select **Authenticate** or **Authenticate/Encrypt** from the Service Security drop-down list on each local service.

- **Use PIN Code (Incoming Connection)**- Select for automatic use of the PIN code entered in the **PIN Code** text box. It is recommended not to use this automatic PIN code feature. See *Security on page 5-2* for more information.
- **PIN Code**- Enter the PIN code.
- **Encrypt Link On All Outgoing Connections**- Select to enable or disable encryption on all outgoing connections to other Bluetooth devices.

Discovery Tab

Use the **Discovery** tab to set and modify discovered devices.



Figure 5-33 BTE Explorer Settings - Discovery

- **Inquiry Length**- Sets the amount of time the MC92N0-G takes to discover Bluetooth devices in the area.
- **Name Discovery Mode**- Select either **Automatic** or **Manual** to automatically attempt to discover a Bluetooth device's name after finding the device.
- **Discovered Devices - Delete Devices**- Deletes all discovered devices and link keys from memory.
- **Discovered Devices - Delete Linked Keys**- Removes all pairing from remote Bluetooth devices, and makes them all un-trusted.

Virtual COM Port Tab

Virtual COM Port defines which COM ports BTE Explorer attempts to use for virtual COM ports. Check the appropriate checkbox to use the port as a virtual COM port. When finished, choose **Apply** to enforce changes, or **Revert** to restore the original settings.

- **COM5:Bluetooth**- Enable or disable COM Port 5.
- **COM9:Bluetooth**- Enable or disable COM Port 9.
- **COM11:Bluetooth**- Enable or disable COM Port 11.
- **COM21:Bluetooth**- Enable or disable COM Port 21.
- **COM22:Bluetooth**- Enable or disable COM Port 22.
- **COM23:Bluetooth**- Enable or disable COM Port 23.

HID Tab

Use the **HID** tab to select The Human Interface Device Profile programming interface defines the protocols and procedures to be used to implement HID capabilities.

Provides support for devices such as mice, joysticks, keyboards.

- **Enable Key Repeat**- Enables key repeat functionality.
- **Delay**- To increase key repeat delay, drag the **Delay** slider to the right. To decrease key repeat delay, drag the **Delay** slider to the left.
- **Rate**- To increase key repeat speed, drag the **Rate** slider to the left. To decrease key repeat speed, drag the **Rate** slider to the right.

Profiles Tab

Use the **Profile** tab to load or remove Bluetooth services profiles. If a profile is not used, it can be removed to save memory.

1. Tap a check box next to the profile to load (activate).
The Serial Port profile is always active and cannot be removed.
2. Tap **Select All** to select all profiles or tap **Deselect All** to deselect all profiles.
3. Tap **Apply** to activate the profiles and then **Close** to exit the application.

System Parameters Tab

- **Page Timeout**- Sets the amount of time the MC92N0-G searches for a device before moving on the next device.
- **Link Supervision Timeout**- Sets the amount of time that the MC92N0-G will wait for a device to come back into range after it has gone out of range. If the device does not come back into range by the set time, the MC92N0-G drops the connection.

Miscellaneous Tab

- **Highlight Connections**- Select the connection type to highlight when connected. In the Wizard Mode, the only options are *Favorites* or *None*. In the Explorer Mode the options are **None**, **Tree View Only**, **List View Only**, or **Tree and List View**.
- **Apply Text Style**- Select the text style to apply to the connection text.
- **Apply Text Color**- Select the text color to apply to the connection text.

CHAPTER 6 USING BLUETOOTH ON ANDROID DEVICES

Introduction

Bluetooth-equipped devices can communicate without wires, using frequency-hopping spread spectrum (FHSS) radio frequency (RF) to transmit and receive data in the 2.4 GHz Industry Scientific and Medical (ISM) band (802.15.1). Bluetooth wireless technology is specifically designed for short-range (10 meters (32.8 feet)) communication and low power consumption.

Devices with Bluetooth capabilities can exchange information (e.g., files, appointments, and tasks) with other Bluetooth enabled devices such as printers, access points, and other mobile devices.

Adaptive Frequency Hopping

Adaptive Frequency Hopping (AFH) is a method of avoiding fixed frequency interferers, and can be used with Bluetooth voice. All devices in the piconet (Bluetooth network) must be AFH-capable in order for AFH to work. There is no AFH when connecting and discovering devices. Avoid making Bluetooth connections and discoveries during critical 802.11b communications. AFH for Bluetooth consists of four main sections:

- **Channel Classification-** A method of detecting an interference on a channel-by-channel basis, or pre-defined channel mask.
- **Link Management-** Coordinates and distributes the AFH information to the rest of the Bluetooth network.
- **Hop Sequence Modification-** Avoids interference by selectively reducing the number of hopping channels.
- **Channel Maintenance-** A method for periodically re-evaluating the channels.

When AFH is enabled, the Bluetooth radio “hops around” (instead of through) the 802.11b high-rate channels. AFH coexistence allows Enterprise devices to operate in any infrastructure.

The Bluetooth radio in this device operates as a Class 2 device power class. The maximum output power is 2.5 mW and the expected range is 10 meters (32.8 ft.). A definition of ranges based on power class is difficult to obtain due to power and device differences, and whether one measures open space or closed office space.



NOTE It is not recommended to perform Bluetooth wireless technology inquiry when high rate 802.11b operation is required.

Security

The current Bluetooth specification defines security at the link level. Application-level security is not specified. This allows application developers to define security mechanisms tailored to their specific need. Link-level security occurs between devices, not users, while application-level security can be implemented on a per-user basis. The Bluetooth specification defines security algorithms and procedures required to authenticate devices, and if needed, encrypt the data flowing on the link between the devices. Device authentication is a mandatory feature of Bluetooth while link encryption is optional.

Pairing of Bluetooth devices is accomplished by creating an initialization key used to authenticate the devices and create a link key for them. Entering a common personal identification number (PIN) in the devices being paired generates the initialization key. The PIN is never sent over the air. By default, the Bluetooth stack responds with no key when a key is requested (it is up to user to respond to the key request event). Authentication of Bluetooth devices is based-upon a challenge-response transaction. Bluetooth allows for a PIN or passkey used to create other 128-bit keys used for security and encryption. The encryption key is derived from the link key used to authenticate the pairing devices. Also worthy of note is the limited range and fast frequency hopping of the Bluetooth radios that makes long-distance eavesdropping difficult.

Recommendations are:

- Perform pairing in a secure environment
- Keep PIN codes private and do not store the PIN codes in the device
- Implement application-level security.

Bluetooth Profiles

The device supports the following Bluetooth services:

- **Service Discovery Protocol (SDP)**- Handles the search for known and specific services as well as general services.
- **Serial Port Profile (SPP)**- Allows use of RFCOMM protocol to emulate serial cable connection between two Bluetooth peer devices. For example, connecting the device to a printer.
- **Object Push Profile (OPP)**- Allows the device to push and pull objects to and from a push server.
- **Advanced Audio Distribution Profile (A2DP)**- Allows the device to stream stereo-quality audio to a wireless headset or wireless stereo speakers.
- **Audio/Video Remote Control Profile (AVRCP)**- Allows the device to control A/V equipment to which a user has access. It may be used in concert with A2DP.
- **Personal Area Network (PAN)**- Allows the use of Bluetooth Network Encapsulation Protocol to provide L3 networking capabilities over a Bluetooth link. Only PANU role is supported.
- **Human Interface Device Profile (HID)**- Allows Bluetooth keyboards, pointing devices, gaming devices and remote monitoring devices to connect to the device.
- **Headset Profile (HSP)**- Allows a hands-free device, such as a Bluetooth headset, to place or receive calls on the device.
- **Hands-Free Profile (HFP)**- Allows car hands-free kits to communicate with the device in a car.

Bluetooth Power States

The Bluetooth radio is off by default.

- **Suspend**- When the MC9200 goes into suspend mode, the Bluetooth radio stays on.
- **Airplane Mode**- When the MC9200 is placed in Airplane Mode, the Bluetooth radio turns off. When Airplane mode is disabled, the Bluetooth radio returns to the prior state. When in Airplane Mode, the Bluetooth radio can be turned back on if desired.

Bluetooth Radio Power



Turn off the Bluetooth radio to save power or if entering an area with radio restrictions (e.g., an airplane). When the radio is off, other Bluetooth devices cannot see or connect to the device. Turn on the Bluetooth radio to exchange information with other Bluetooth devices (within range). Communicate only with Bluetooth radios in close proximity.

NOTE To achieve the best battery life turn off radios when not in use.

Enabling Bluetooth



1. Touch .
2. Slide the Bluetooth switch to the **ON** position.  also appears in the Status bar.
3. Touch .

Disabling Bluetooth

1. Touch .
2. Slide the Bluetooth switch to the **OFF** position.
3. Touch .

Discovering Bluetooth Device(s)

The MC9200 can receive information from discovered devices without pairing. However, once paired, the MC9200 and a paired device exchange information automatically when the Bluetooth radio is on. To find Bluetooth devices in the area:

1. Ensure that Bluetooth is enabled on both devices.
2. Ensure that the Bluetooth device to discover is in discoverable mode.
3. Ensure that the two devices are within 10 meters (32.8 feet) of one another.
4. Touch .
5. Touch  **Bluetooth**.
6. Touch **SCAN FOR DEVICES**. The MC9200 begins searching for discoverable Bluetooth devices in the area and displays them under **AVAILABLE DEVICES**.
7. Scroll through the list and select a device. The **Bluetooth pairing request** dialog box appears.

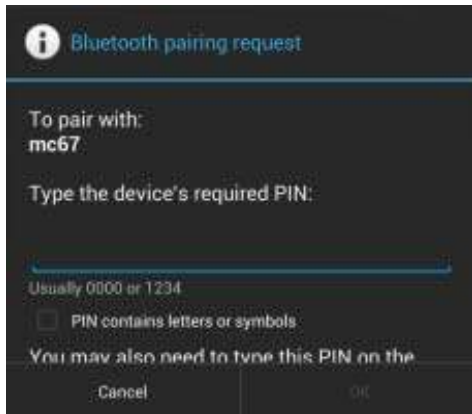

Figure 6-1 Bluetooth Pairing - Enter PIN

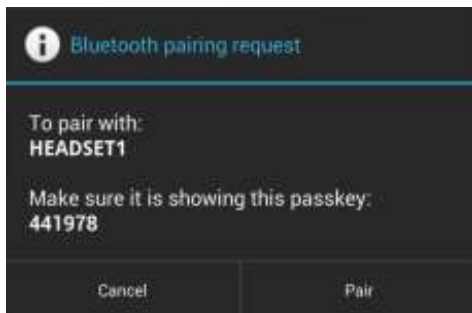





Figure 6-2 Bluetooth Pairing - Smart Pairing

8. Enter a PIN in the text box and touch **OK**. Enter the same PIN on the other device.
9. For Simple Pairing, touch **Pair** on both devices.
10. The Bluetooth device is added to the **Bluetooth devices** list and a trusted (“paired”) connection is established.



Changing the Bluetooth Name

By default, the MC9200 has a generic Bluetooth name that is visible to other devices when connected.

1. Touch .
2. Touch  **Bluetooth**.
3. If Bluetooth is not on, slide the switch to the **ON** position.
4. Touch .
5. Touch **Rename device**.
6. Enter a name and touch **Done**.
7. Touch .





Connecting to a Bluetooth Device

Once paired, connect to a Bluetooth device.

1. Touch .
2. Touch  **Bluetooth**.
3. If Bluetooth is not on, slide the switch to the **ON** position.
4. In the **PAIRED DEVICES** list, touch and hold on a unconnected Bluetooth device until a menu appears.
5. Touch **Connect**. When connected, the device is displayed as connected in the list.

Selecting Profiles on the Bluetooth Device

Some Bluetooth devices have multiple profiles. To select a profile:

1. Touch .
2. Touch  **Bluetooth**.
3. In the **PAIRED DEVICES** list, touch  next to the device name.
4. Under **PROFILES**, check or uncheck a profile to allow the device to use that profile.
5. Touch .

Unpairing a Bluetooth Device

To unpair a Bluetooth device and erase all pairing information:

1. Touch .
2. Touch  **Bluetooth**.
3. In the **PAIRED DEVICES** list, touch  next to the device name.
4. Touch **Unpair**.
5. Touch .

CHAPTER 7 ACCESSORIES

Introduction

The MC92N0-G accessories provide a variety of product support capabilities. [Table 7-1](#) lists the accessories available.

Table 7-1 MC92N0-G Accessories

Accessory	Part Number	Description
Cradles		
Single Slot Serial/USB Cradle	CRD9000-1001SR	Charges the MC92N0-G main battery and a spare battery. It also synchronizes the MC92N0-G with a host computer through either a serial or a USB connection.
Four Slot Ethernet Cradle	CRD9101-4001ER	Charges the MC92N0-G main battery and synchronizes the MC92N0-G with a host computer through an Ethernet connection.
Fork Lift Cradle	FLC9000-1000R	Provides secure mounting solution for the MC92N0-G. The cradle is equipped with rugged RS232 and USB ports which are capable of powering and communicating with tethered devices.
Chargers		
Four Slot Spare Battery Charger	SAC9000-4000R	Charges up to four MC92N0-G spare batteries.
Universal Battery Charger Adapter	21-32665-48R	Charges an spare battery as a stand-alone charger or with the UBC2000 base.
UBC Four Slot Base	UBC2000-I500DR	Charges up to four batteries using the UBC adapter.

Table 7-1 MC92N0-G Accessories (Continued)

Accessory	Part Number	Description
12 Volt Auto Charge Cable	VCA9001-12R	Plugs into a 12 volt cigarette lighter to charge the MC92N0-G while on the road. Requires the Cable Adapter (ADP9000-100R).
24 Volt Auto Charge Cable	VCA9000-24R	Plugs into a 24 volt cigarette lighter to charge the MC92N0-G while on the road. Requires the Cable Adapter (ADP9000-100R).
Spare lithium-ion battery	BTRY-MC9X-26MA-01	Replacement battery.
Power Supply	PWRS-14000-148R	Provides power to the Single Slot Serial/USB cradle. 100 - 240 VAC input, 12 VDC 3.33 A output.
Power Supply	PWRS-14000-242R	85 - 264 VAC input, 12 VDC 3.33 A output.
Power Supply	PWRS-14000-241R	Provides power to the Four Slot Charge Only cradle and Four Slot Ethernet cradle. 90 - 264 VAC input, 12 VDC 9 A output.
Fork Lift High Voltage Power Converter	PWRS-14000-251R	Provides power to the Fork Lift Cradle.
Fork Lift Low Voltage Power Converter	PWRS-14000-252R	Provides power to the Fork Life Cradle.
Cables		
DC Line Cord	50-16002-029R	Provides power from the power supply to the Four Slot Charge Only and Ethernet cradles.
DC Line Cord	25-72614-01R	Provides power from power supply to the Four Slot Charge Only and Four Slot Ethernet cradles.
Fork Lift Power Input Cable	25-103872-01R	Provides power from the power supply to the Fork Lift Cradle.
USB Sync Cable	25-64396-01R	Provides USB communication with a host computer through the Single Slot Serial/USB cradle.
USB Cable	25-62166-01R	Provides USB communication to the host through the Cable Adapter Module (ADP9000-100R).
DEX Cable with Floating Jack Screws	25-62167-03R	Provides electronic data exchange to the host through the Cable Adapter Module (ADP9000-100R).
Paxar Printer Cable	25-62168-01R	Connects the MC92N0-G to a Paxar printer.
O'Neil Printer Cable	25-62169-01R	Connects the MC92N0-G to an O'Neil printer.
Zebra Printer Cable	25-62170-02R	Connects the MC92N0-G to a Zebra printer.
Modem Cable	25-63856-01R	Allows the Single Slot Serial/USB cradle to be used as a modem cradle.

Table 7-1 MC92N0-G Accessories (Continued)

Accessory	Part Number	Description
Serial Cable	25-63852-01R	Provides serial communication from the Single Slot Serial/USB cradle to a host computer.
Soft Goods		
Holster	SG-MC91212112-01R	Holds the MC92N0-G when not in use.
Heated Boot	SG-MC9024242-01R	Maintains operating temperature of the MC92N0-G when in a freezer environment.
Handstrap	KT-66447-03R	Package of 3 handstraps.
Belt	11-08062-02R	For use with holster.
Protective Boot	11-67218-04R	Provides additional protection for MC9XXX-G configurations.
Shoulder Strap	58-40000-007R	Universal shoulder strap for holster.
Snap-on		
Cable Adapter Module (CAM)	ADP9000-120R	Attaches to the bottom of the MC92N0-G and provides power (5 VDC 350 mA) for use to cable to Apriva BT200 Reader.
Cable Adapter Module (CAM)	ADP9000-110R	Attaches to the bottom of the MC92N0-G and provides power (5 VDC 350 mA) for use with the LS3408ER scanner.
Cable Adapter Module (CAM)	ADP9000-100R	Attaches to the bottom of the MC92N0-G and provides power for operating change charging the MC92N0-G and provides serial communication.
Keypads		
28-key keypad	KYPD-MC9XMR000-01R	Replacement 28-key keypad.
53-key keypad	KYPD-MC9XMS000-01R	Replacement 53-key keypad.
43-key keypad	KYPD-MC9XMT000-01R	Replacement 43-key keypad.
53-key VT keypad	KYPD-MC9XMU000-01R	Replacement 53-key VT keypad.
53-key 3270 keypad	KYPD-MC9XMV000-01R	Replacement 53-key 3270 keypad.
53-key 5250 keypad	KYPD-MC9XMW000-01R	Replacement 53-key 5250 keypad.
53-key High Visibility keypad	KYPD-MC9XMS000-01R	Replacement 53-key white key keypad.
Miscellaneous		
MC90XX Wall Mounting Bracket	KT-61498-01R	Order one for Single Slot cradle and one for the SAC9000. Order two for Four Slot Cradles. Order Cradle Bracket separately to attach to the wall mount bracket.

Table 7-1 MC92N0-G Accessories (Continued)

Accessory	Part Number	Description
MC90XX Cradle Bracket	KT-61499-01R	Order one for Single Slot cradle and one for the SAC9000. Order two for Four Slot Cradles. Attaches to the bottom of the cradle.
Screen Protector	KT-151827-03R	Adds an additional level of protection for the MC9XXX screen to protect against scratches. (3-pack).
Stylus Kit	KT-81680-50R	Replacement gray stylus with tether for MC92N0-G (50-pack).
Stylus Kit	KT-81680-03R	Replacement gray stylus with tether for MC92N0-G (3-pack).
Belt Clip	KT-70147-01R	Attaches to a user's belt.
Rugged Cable Headset	RCH51	Rugged headset
RCH51 Adapter Cable	25-124387-02R	RCH50 adapter cable for standard 3-pole, 2.5mm barrel jack used with MC92N0-G.
Stylus Kit	KT-68144-10R	Replacement gray stylus for MC92N0-G (10-pack).
Stylus Kit	KT-68144-50R	Replacement gray stylus for MC92N0-G (50-pack).

Secure Device (SD) Card

The SD card provides secondary non-volatile storage. The SD card is located under the keypad.



CAUTION Do not remove the keypad while the MC92N0-G is on and do not operate the MC92N0-G with the keypad detached. Follow proper ESD precautions to avoid damaging the SD card. Proper ESD precautions include, but are not limited to, working on an ESD mat and ensuring that the operator is properly grounded.

To insert the SD card:

1. Suspend the MC92N0-G.
2. Remove the two keypad screws and slide the keypad down and lift off.
3. Lift the SD card retaining door.
4. Position the SD card, with the contacts down, into the SD card holder. The SD card corner notch fits into the holder only one way. Snap the retaining door closed.

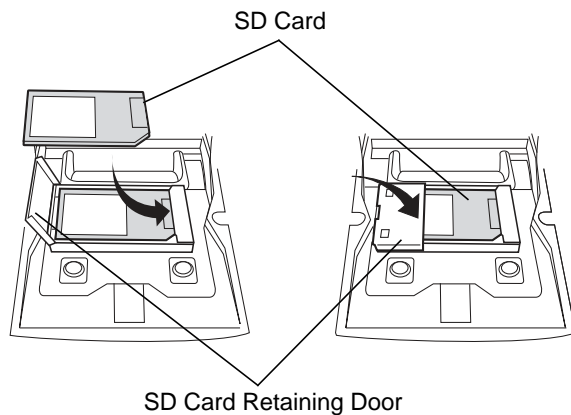

Figure 7-1 *Inserting the SD Card*



CAUTION Do not apply more than 4 in-lbs of torque when tightening the keypad screws.

5. Replace the keypad and re-attach using the two screws.
6. Perform a warm boot.

Single Slot Serial/USB Cradle



CAUTION Ensure that you follow the guidelines for battery safety described in *Battery Safety Guidelines* on page 8-1.

This section describes how to use a single Single Slot Serial/USB cradle (*Figure 7-2*) with the MC92N0-G. For serial and USB communication setup procedures refer to the *MC92N0-G Integrator Guide*.

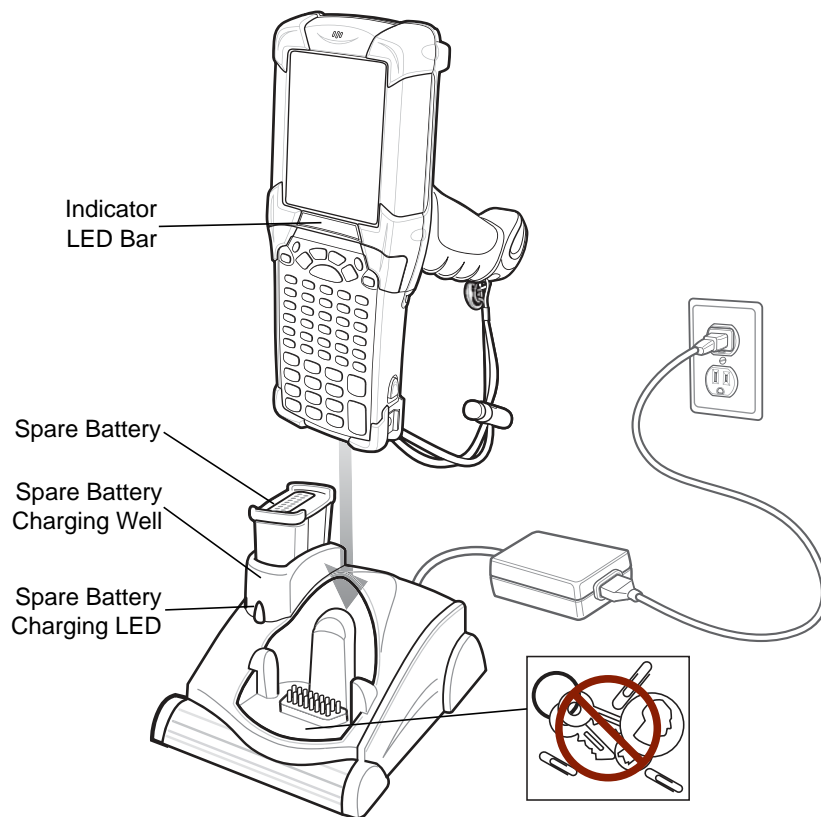

Figure 7-2 Single Slot Serial/USB Cradle



CAUTION Do not place coins, keys or paper clips in cradle well.

The Single Slot Serial/USB Cradle has the following attributes:

- Provides 12 VDC power for operating the MC92N0-G.
- Provides serial (Windows devices only) and USB ports for data communication between the MC92N0-G and a host computer or other serial devices (e.g., a printer).



NOTE When a MC92N0-G with Windows Embedded Handheld is placed in the cradle and an ActiveSync connection is made, the WLAN radio (if applicable) is disabled. This is a Microsoft security feature to prevent connection to two networks at the same time.

- Synchronizes information between the MC92N0-G and a host computer. (With customized or third party software, it can also be used to synchronize the MC92N0-G with corporate databases.)
- Charges the MC92N0-G's battery.
- Charges a spare battery.

The Single Slot Serial/USB Cradle can charge the MC92N0-G's main battery and a spare battery simultaneously.

The MC92N0-G's amber charge LED, located in the Indicator LED Bar, shows the status of the battery charging in the MC92N0-G. See [Table 1-1 on page 1-4](#) for charging status indications.

The amber spare battery charging LED on the cradle (see [Figure 7-2 on page 7-6](#)) shows the status of the spare battery charging in the cradle. See [Table 7-3](#) for charging status indications.

Batteries usually charge in less than four hours.

Table 7-2 Spare Battery LED Charging Indicators

Spare Battery LED (on cradle)	Indication
Off	No spare battery in well; spare battery not placed correctly; cradle is not powered.
Fast Blinking Amber	Error in charging; check placement of spare battery.
Slow Blinking Amber	Spare battery is charging.
Solid Amber	Charging complete.

Four Slot Ethernet Cradle



CAUTION Ensure that you follow the guidelines for battery safety described in *Battery Safety Guidelines* on page 8-1.

This section describes how to use a Four Slot Ethernet cradle with the MC92N0-G.

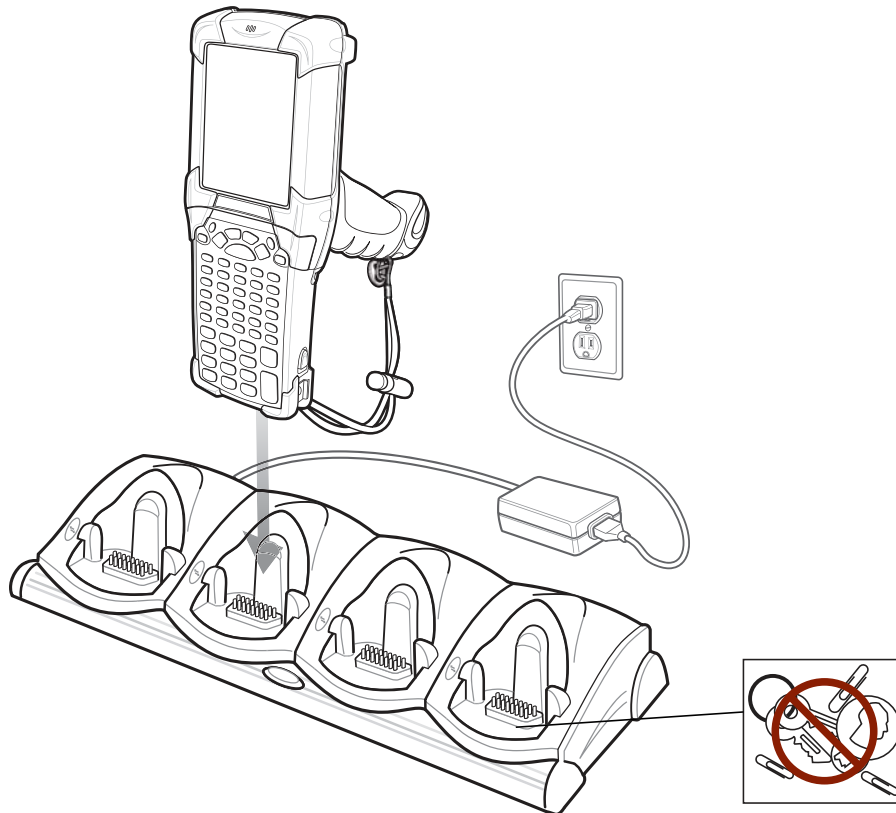

Figure 7-3 Four Slot Ethernet Cradle



CAUTION Do not place coins, keys or paper clips in cradle well.

The Four Slot Ethernet cradle:

- Provides 12 VDC power for operating the MC92N0-G.
- Enables data communication between the MC92N0-G (up to four) and a host computer, over an Ethernet network (using a standard 10Base-T Ethernet cable).
- Synchronizes information between the MC92N0-G and a host computer. (With customized or third party software, it can also be used to synchronize the MC92N0-G with corporate databases.)
- Simultaneously charges up to four batteries in the MC92N0-G.

The MC92N0-G's amber charge LED, located in the Indicator LED Bar, shows the status of the battery charging in the MC92N0-G. See [Table 1-1 on page 1-4](#) for charging status indications.

The battery usually charges in less than four hours.

Four Slot Charge Only Cradle



CAUTION Ensure that you follow the guidelines for battery safety described in *Battery Safety Guidelines* on page 8-1.

This section describes how to use a Four Slot Charge Only cradle with the MC92N0-G.

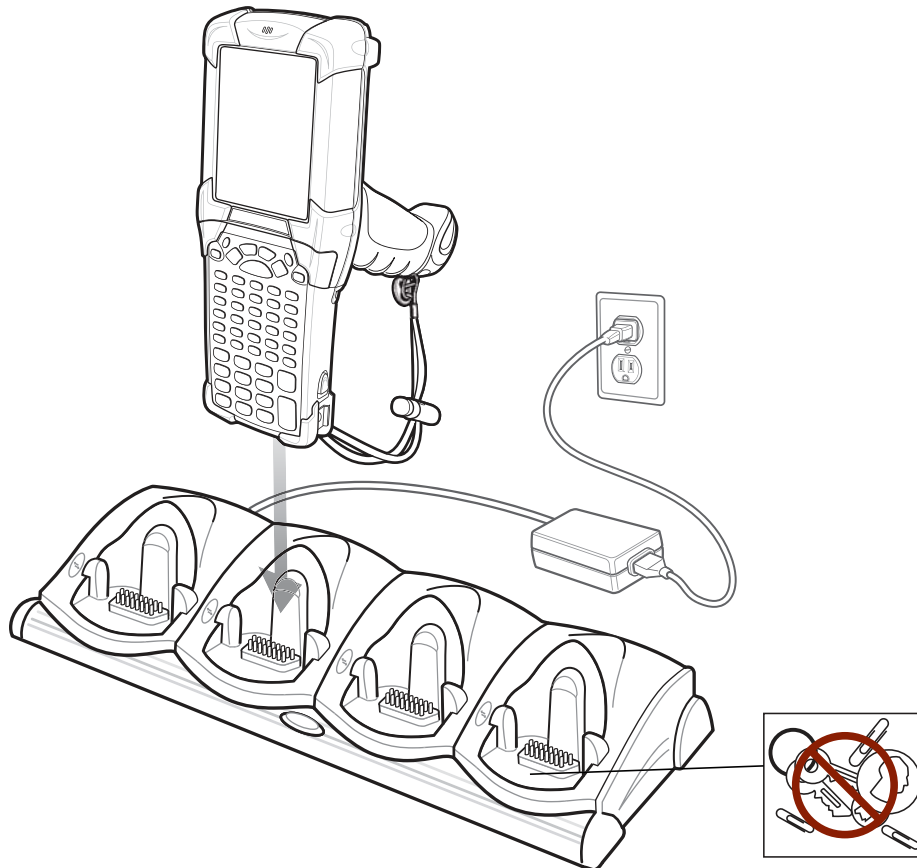

Figure 7-4 Four Slot Charge Only Cradle



CAUTION Do not place coins, keys or paper clips in cradle well.

The Four Slot Charge Only cradle:

- Provides 12 VDC power for operating the MC92N0-G.
- Simultaneously charges up to four batteries in the MC92N0-G.

The MC92N0-G's amber charge LED, located in the Indicator LED Bar, shows the status of the battery charging in the MC92N0-G. See [Table 1-1 on page 1-4](#) for charging status indications.

The battery usually charges in less than four hours.

Four Slot Spare Battery Charger



CAUTION Ensure that you follow the guidelines for battery safety described in *Battery Safety Guidelines* on page 8-1.

This section describes how to use the Four Slot Spare Battery Charger to charge up to four MC9200 spare batteries.

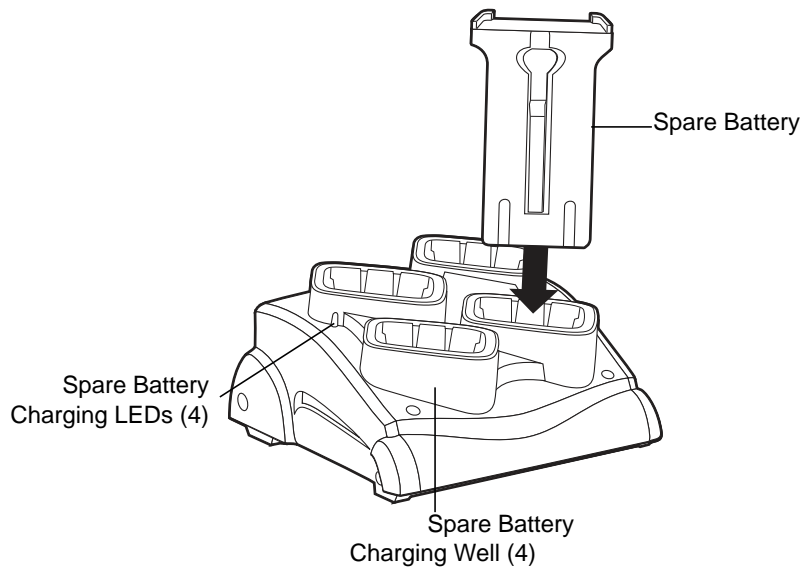

Figure 7-5 Four Slot Spare Battery Charger

Insert the battery into a spare battery charging slot and gently press down on the battery to ensure proper contact. An amber LED is provided on each battery charging well. See [Table 7-2](#) for charging status indications. The battery usually charges in less than four hours.

Table 7-3 Spare Battery LED Charging Indicators

LED	Indication
Off	No spare battery in slot; spare battery not placed correctly; cradle is not powered.
Fast Blinking Amber	Error in charging; check placement of spare battery.
Slow Blinking Amber	Spare battery is charging.
Solid Amber	Charging complete.

Cable Adapter Module

This section describes how to set up and use the snap-on CAM with the MC92N0-G. The CAM snaps on to the bottom of the MC92N0-G and can be easily removed when not in use.

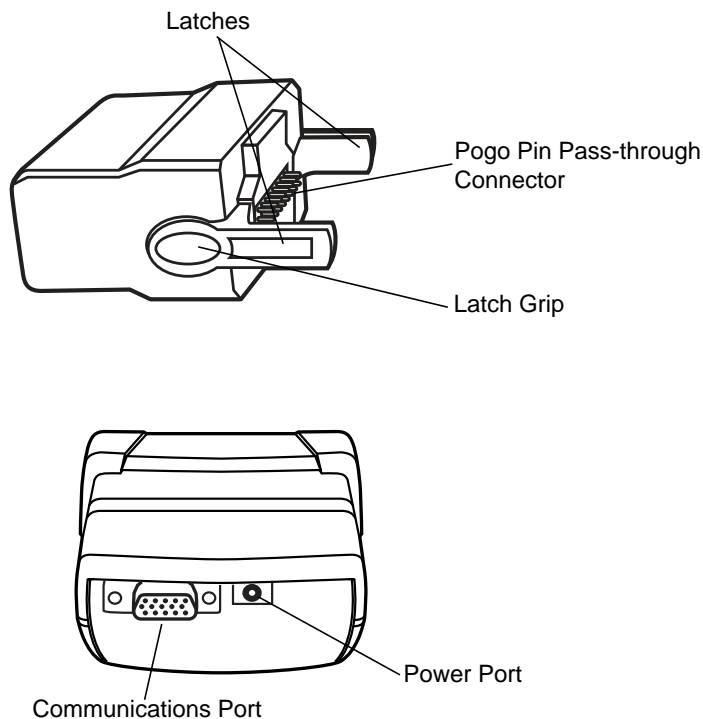

Figure 7-6 Cable Adapter Module

When attached to the MC92N0-G, the CAM can perform the following functions.

- Provides power for operating the MC92N0-G, with the appropriate power connection.
- ✓ **NOTE** When a MC92N0-G with Windows Embedded Handheld is connected to a host computer through the CAM and an ActiveSync connection is made, the WLAN radio (if applicable) are disabled. This is a Microsoft security feature to prevent connection to two networks at the same time.
- Provides serial connection through the serial pass-through port for communication with a serial device, such as a host computer (Windows devices only).
- Provides USB connection through the USB pass-through port for communication with a USB device, such as a host computer.
- Charges the MC92N0-G's battery, when used with the appropriate power supply.

Attaching and Removing

To attach, snap the CAM onto the bottom of the MC92N0-G.

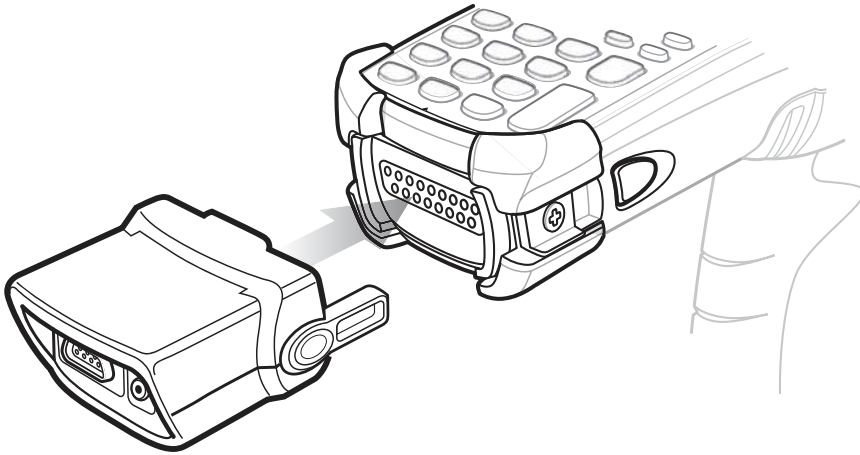

Figure 7-7 Attaching the CAM

To remove, squeeze the latch grips and pull the CAM from the MC92N0-G.

✓ **NOTE** Remove the CAM from the bottom of the MC92N0-G before using a cradle for charging and communication.

Setup

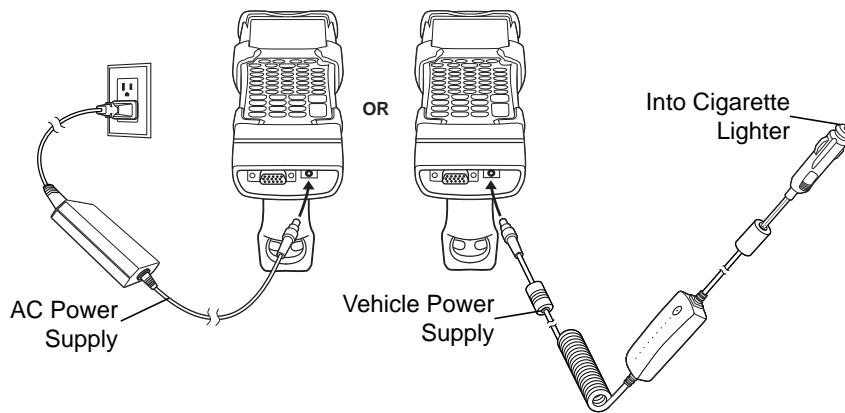

Figure 7-8 CAM Power Connection

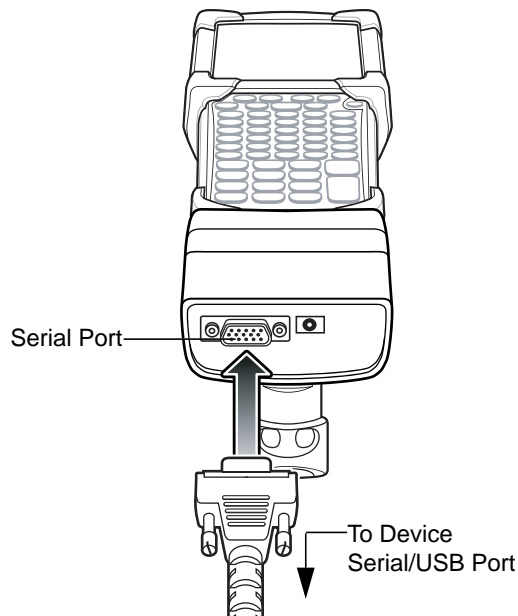

Figure 7-9 CAM Serial Connection

Battery Charging Indicators

To charge the MC92N0-G's battery through the CAM, connect the power supply to the CAM (see [Figure 7-8 on page 7-12](#)), then attach the CAM to the MC92N0-G. The MC92N0-G begins charging automatically.

✓ **NOTE** Batteries must be charged within the 32° to 104° F (0° to +40° C) ambient temperature range.

The MC92N0-G's amber charge LED, located in the Indicator LED Bar, shows the status of the battery charging in the MC92N0-G. See [Table 1-1 on page 1-4](#) for charging status indications.

The battery usually charges in less than four hours, if the MC92N0-G is not in use.

Serial/USB Connection

✓ **NOTE** Android devices do not support serial communication.

The CAM can connect to and communicate with a serial/USB device, such as a printer or host computer, through its serial port.

To connect the CAM to a serial/USB device, connect one end of the serial device cable into the serial port on the CAM and the other end into the serial/USB port on the device.

Universal Battery Charger (UBC) Adapter



CAUTION Ensure that you follow the guidelines for battery safety described in *Battery Safety Guidelines* on page 8-1.

This section describes how to use the UBC adapter to charge a spare battery.

The UBC can be used with a power supply as a standalone spare battery charger or it can be used with the four station UBC2000 to provide charging to simultaneously charge up to four spare batteries. For additional information about the UBC2000, see the *UBC 2000 Universal Battery Charger Product Guide* (p/n 70-33188-xx).

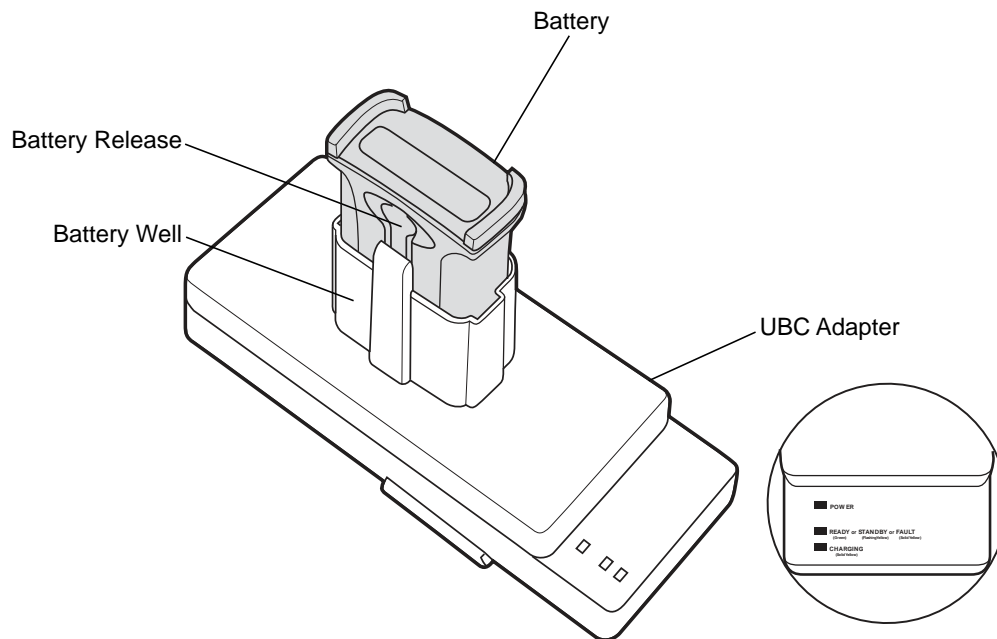

Figure 7-10 UBC Adapter

Inserting and Removing a Battery

Insert the battery into the battery well with the charging contacts facing down (over charging pins) and gently press down on the battery to ensure proper contact.

To remove the battery, press the battery release and lift battery out of the well.

Battery Charging Indicators

To charge a spare battery using the UBC adapter, connect the power supply to the UBC, then insert the spare battery. The spare battery begins charging automatically.

The UBC's charge LEDs (see [Figure 7-11](#)) show the status of the battery charging in the adapter. [Table 7-2](#) shows battery charging status indications.

The battery usually charges in three hours.

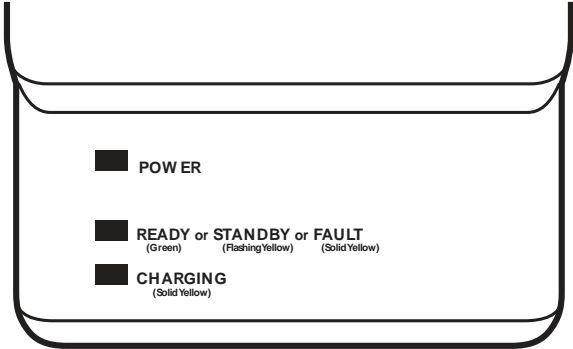

Figure 7-11 UBC Adapter LEDs

Table 7-4 UBC Adapter Charge LED Status Indications

LED	Indication	Description
POWER	Green	Power is connected to the UBC Adapter.
READY or	Green	Charging complete.
STANDBY or	Flashing-Yellow	The battery was deeply discharged and is being trickle charged to bring the voltage up to the operating level. After operating level voltage is achieved the battery charges normally.
FAULT	Yellow	Charging error, check placement of MC92N0-G/spare battery.
CHARGING	Yellow	Normal charge.

Forklift Cradle

The Forklift cradle:

- holds a MC92N0-G securely in place.
- provides power for operating the MC92N0-G.
- provides power for charging a docked MC92N0-G.
- provides one serial and one USB port for data communication between a docked MC92N0-G and an external device (e.g., a scanner/printer). Note that Android devices only support USB.
- provides power to each port (500mA at 5V). Both ports can be used simultaneously.

When installed without the power converter, the cradle holds a MC92N0-G securely in place.

The power converter conditions the fork lift battery power for the fork lift cradle. There is a high-voltage and low-voltage version of the power converter. Make sure that you have ordered the correct converter.

- Low Voltage (Model: 50-14000-252R) — For nominal voltage input of 12V and 24V systems.
- High Voltage (Model: 50-14000-251R) — For nominal voltage input of 36V, 48V, and 60V systems.

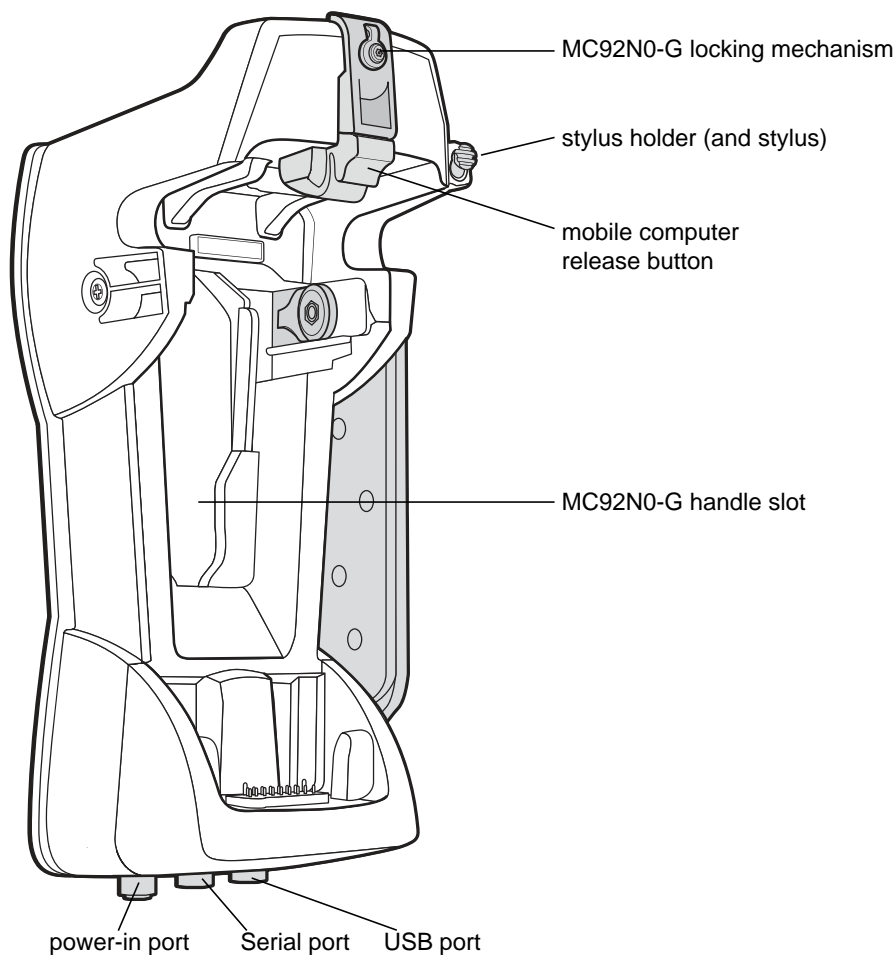

Figure 7-12 *Forklift Cradle*

MC92N0-G Insertion and Removal

To insert the MC92N0-G into the fork lift cradle, place the bottom of the MC92N0-G into the bottom of the fork lift cradle, then press the MC92N0-G back into the cradle until the release button locks it in place.



WARNING! Ensure the bottom of the MC92N0-G is fully seated into the cup before you push the MC92N0-G into the fork lift cradle. Failure to do so may cause property damage.

Ensure the MC92N0-G is fully inserted into the fork lift cradle and the release button is holding it securely in place. Pull on the MC92N0-G to ensure it is secured properly. Improper insertion can result in property damage or personal injury.

Do not use the product while driving.

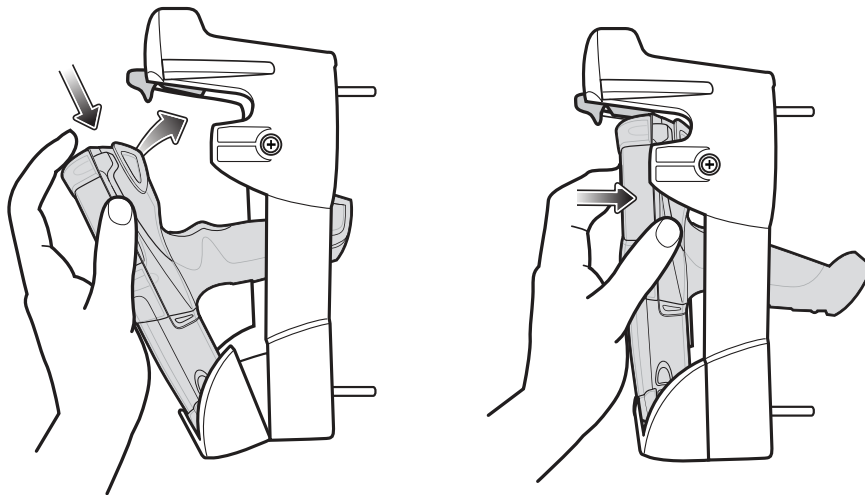

Figure 7-13 Insert MC92N0-G into Forklift Cradle

To remove the MC92N0-G from the fork lift cradle, lift the release button, then lift the MC92N0-G from the cradle. For one handed removal, use the index finger to press the release button up and then remove the MC92N0-G with your thumb and other fingers.

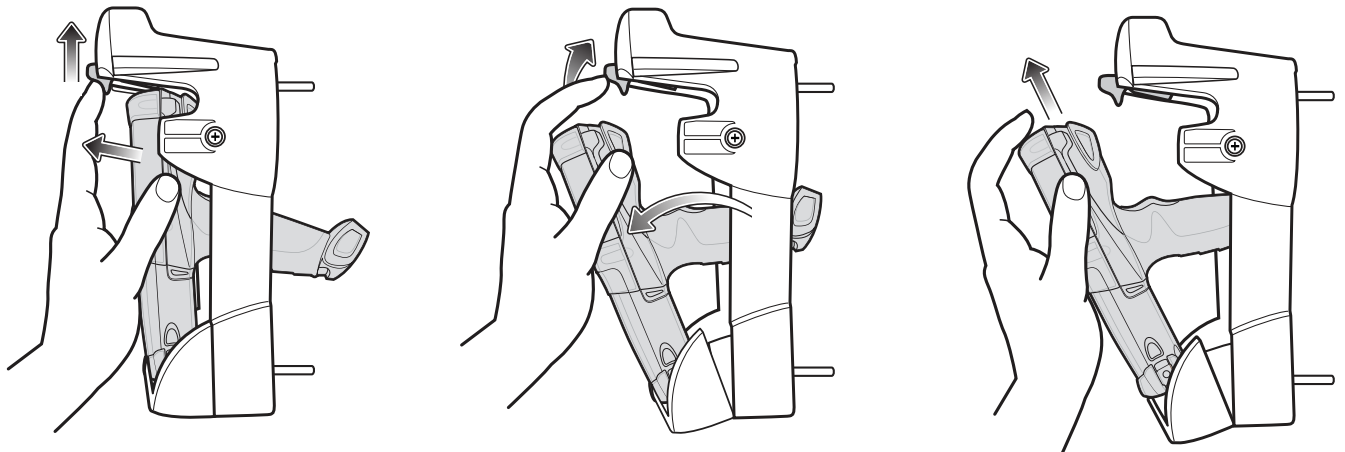

Figure 7-14 Remove MC92N0-G from Forklift Cradle

Using the Locking Mechanism

The locking mechanism prohibits the removal of the MC92N0-G from the fork lift cradle. To use the locking mechanism, with the MC92N0-G in the fork lift cradle, place the locking mechanism into the position behind the release button. Secure it with the attached screw. To remove the locking mechanism, loosen the screw securing it in place.

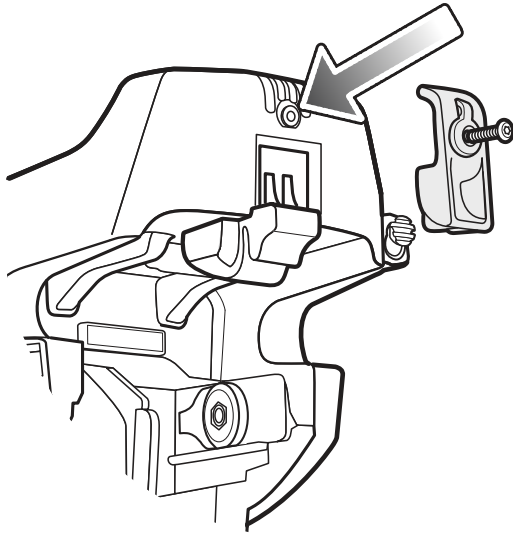

Figure 7-15 Locking Mechanism

Connecting External Devices

The ports on the fork lift cradle are available to enable communication between a docked MC92N0-G and external devices such as a scanner and/or a printer.

A serial (Windows devices only) and/or a USB port are available. Connect one end of the cable (serial or USB cable) to the port on the fork lift cradle, and then connect the other end to the port on the external device. Specific cables are required.

✓ **NOTE** When used with a USB client device, the MC92N0-G must be configured as a USB Host.

To place the MC92N0-G into Host mode:

1. On Windows device, tap **Start > Settings > Control Panel > USBConfig** icon.
On Android device, touch **⚙ > USBConfig**.
2. Tap the **USB Host Mode** radio button.
3. Tap **OK**.

To begin communication:

1. Insert the MC92N0-G into the fork lift cradle.
2. Initiate communication on the MC92N0-G, as determined by the application used.



CAUTION Removing the MC92N0-G during communication disrupts communication between the MC92N0-G and the attached device.

Supported Scanners

The forklift cradle supports the following scanners:

- LS3408-FZ20005R (requires USB cable 25-71918-01R or serial cable 25-71917-02R)
- LS3408-ER20005R (requires USB cable 25-71918-01R or serial cable 25-71917-02R)
- LS3478 scanner with FLB3478-C0007WR cradle (requires USB cable 25-71918-01R or serial cable 25-71917-02R)
- LS3578 *Bluetooth*[®] scanner with FLB3508-C007WR cradle (requires USB cable 25-71918-01R or serial cable 25-71917-02R). Note that Android devices support USB only.
- LS3578 *Bluetooth*[®] scanner with FLB3578-C007WR cradle (requires USB cable 25-71918-01R or serial cable 25-71917-02R). Note that Android devices support USB only.
- LS3203 (requires serial cable 25-71916-01R). Note that Android devices support USB only.
- LS42XX (requires USB cable 25-71918-01R or serial cable 25-71917-02R). Note that Android devices support USB only.

CHAPTER 8 MAINTENANCE & TROUBLESHOOTING

Introduction

This chapter includes instructions on cleaning and storing the MC92N0-G, and provides troubleshooting solutions for potential problems during MC92N0-G operation.

Maintaining the MC92N0-G

For trouble-free service, observe the following tips when using the MC92N0-G:

- Protect the MC92N0-G from temperature extremes. Do not leave it on the dashboard of a car on a hot day, and keep it away from heat sources.
- Do not store or use the MC92N0-G in any location that is extremely dusty, damp, or wet.
- Use a soft lens cloth to clean the MC92N0-G. If the surface of the MC92N0-G screen becomes soiled, clean it with a soft cloth moistened with a diluted window-cleaning solution.
- Periodically replace the rechargeable Li-ion battery to ensure maximum battery life and product performance. Battery life depends on individual usage patterns.
- Take care not to scratch the screen of the MC92N0-G. When working with the MC92N0-G, use the supplied stylus or plastic-tipped pens intended for use with a touch-sensitive screen. Never use an actual pen or pencil or other sharp object on the surface of the MC92N0-G screen.
- The touch-sensitive screen of the MC92N0-G contains glass. Take care not to drop the MC92N0-G or subject it to strong impact.

Battery Safety Guidelines

- The area in which the units are charged should be clear of debris and combustible materials or chemicals. Particular care should be taken where the device is charged in a non commercial environment.
- Follow battery usage, storage, and charging guidelines found in the user's guide.
- Improper battery use may result in a fire, explosion, or other hazard.
- To charge the mobile device battery, the battery and charger temperatures must be between +32 °F and +104 °F (0 °C and +40 °C)

- Do not use incompatible batteries and chargers. Use of an incompatible battery or charger may present a risk of fire, explosion, leakage, or other hazard. If you have any questions about the compatibility of a battery or a charger, contact Zebra Global Customer Support.
- For devices that utilize a USB port as a charging source, the device shall only be connected to products that bear the USB-IF logo or have completed the USB-IF compliance program.
- Do not disassemble or open, crush, bend or deform, puncture, or shred.
- Severe impact from dropping any battery-operated device on a hard surface could cause the battery to overheat.
- Do not short circuit a battery or allow metallic or conductive objects to contact the battery terminals.
- Do not modify or remanufacture, attempt to insert foreign objects into the battery, immerse or expose to water or other liquids, or expose to fire, explosion, or other hazard.
- Do not leave or store the equipment in or near areas that might get very hot, such as in a parked vehicle or near a radiator or other heat source. Do not place battery into a microwave oven or dryer.
- Battery usage by children should be supervised.
- Please follow local regulations to promptly dispose of used re-chargeable batteries.
- Do not dispose of batteries in fire.
- Seek medical advice immediately if a battery has been swallowed.
- In the event of a battery leak, do not allow the liquid to come in contact with the skin or eyes. If contact has been made, wash the affected area with large amounts of water and seek medical advice.
- If you suspect damage to your equipment or battery, contact Zebra support to arrange for inspection.

Cleaning



CAUTION Always wear eye protection.

Read warning label on compressed air and alcohol product before using.

If you have to use any other solution for medical reasons please contact Zebra for more information.



WARNING! Avoid exposing this product to contact with hot oil or other flammable liquids. If such exposure occurs, unplug the device and clean the product immediately in accordance with these guidelines.

Approved Cleanser Active Ingredients

100% of the active ingredients in any cleaner must consist of one or some combination of the following: isopropyl alcohol, bleach/sodium hypochlorite, hydrogen peroxide or mild dish soap.

Harmful Ingredients

The following chemicals are known to damage the plastics on the MC92N0-G and should not come in contact with the device: ammonia solutions, compounds of amines or ammonia; acetone; ketones; ethers; aromatic and chlorinated hydrocarbons; aqueous or alcoholic alkaline solutions; ethanalamine; toluene; trichloroethylene; benzene; carbolic acid and TB-lysoform.

Cleaning Instructions

Do not apply liquid directly to the MC92N0-G. Dampen a soft cloth or use pre-moistened wipes. Do not wrap the device in the cloth or wipe, but gently wipe the unit. Be careful not to let liquid pool around the display window or other places. Allow the unit to air dry before use.

Special Cleaning Notes

Many vinyl gloves contain phthalate additives, which are often not recommended for medical use and are known to be harmful to the housing of the MC92N0-G. The MC92N0-G should not be handled while wearing vinyl gloves containing phthalates, or before hands are washed to remove contaminant residue after gloves are removed. If products containing any of the harmful ingredients listed above are used prior to handling the MC92N0-G, such as hand sanitizer that contain ethanolamine, hands must be completely dry before handling the MC92N0-G to prevent damage to the plastics.

Materials Required

- Alcohol wipes
- Lens tissue
- Cotton tipped applicators
- Isopropyl alcohol
- Can of compressed air with a tube.

Cleaning the MC92N0-G

Housing

Using the alcohol wipes, wipe the housing including keys and in-between keys.

Display

The display can be wiped down with the alcohol wipes, but care should be taken not to allow any pooling of liquid around the edges of the display. Immediately dry the display with a soft, non-abrasive cloth to prevent streaking.

Scanner Exit Window

Wipe the scanner exit window periodically with a lens tissue or other material suitable for cleaning optical material such as eyeglasses.

Battery Contacts

1. Remove the main battery from the MC92N0-G.
2. Dip the cotton portion of the cotton tipped applicator in isopropyl alcohol.
3. Rub the cotton portion of the cotton tipped applicator back-and-forth across the battery contacts on the bottom of the battery. Do not leave any cotton residue on the contacts.
4. Repeat at least three times.
5. Use the cotton tipped applicator dipped in alcohol to remove any grease and dirt near the connector area.
6. Use a dry cotton tipped applicator and repeat steps 3 through 5.
7. Spray compressed air on the connector area by pointing the tube/nozzle about ½ inch away from the surface.



CAUTION Do not point nozzle at yourself and others, ensure the nozzle or tube is away from your face.

8. Inspect the area for any grease or dirt, repeat if required.
9. Replace the battery in the MC92N0-G.

Cleaning Cradle Connectors

To clean the connectors on a cradle:

1. Remove the DC power cable from the cradle.
2. Dip the cotton portion of the cotton tipped applicator in isopropyl alcohol.
3. Rub the cotton portion of the cotton tipped applicator along the pins of the connector. Slowly move the applicator back-and-forth from one side of the connector to the other. Do not let any cotton residue on the connector.
4. All sides of the connector should also be rubbed with the cotton tipped applicator.
5. Spray compressed air in the connector area by pointing the tube/nozzle about ½ inch away from the surface.



CAUTION Do not point nozzle at yourself and others, ensure the nozzle or tube is away from your face.

6. Ensure that there is no lint left by the cotton tipped applicator, remove lint if found.
7. If grease and other dirt can be found on other areas of the cradle, use lint free cloth and alcohol to remove.
8. Allow at least 10 to 30 minutes (depending on ambient temperature and humidity) for the alcohol to air dry before applying power to cradle.

If the temperature is low and humidity is high, longer drying time is required. Warm temperature and dry humidity requires less drying time.

Cleaning Frequency

The cleaning frequency is up to the customer's discretion due to the varied environments in which the mobile devices are used. They may be cleaned as frequently as required. However when used in dirty environments it may be advisable to periodically clean the scanner exit window to ensure optimum scanning performance.

Troubleshooting

MC92N0-G

Table 8-1 *Troubleshooting the MC92N0-G*

Problem	Cause	Solution
MC92N0-G does not turn on.	Lithium-ion battery not charged.	Charge or replace the lithium-ion battery in the MC92N0-G.
	Lithium-ion battery not installed properly.	Ensure battery is installed properly. See <i>Installing the Main Battery</i> on page 1-2.
	System crash.	Perform a warm boot. If the MC92N0-G still does not turn on, perform a cold boot. See <i>Resetting the MC92N0-G</i> on page 2-24 for Windows devices and <i>Resetting the Android Device</i> on page 3-15 for Android devices.
Rechargeable lithium-ion battery did not charge.	Battery failed.	Replace battery. If the MC92N0-G still does not operate, try a warm boot, then a cold boot. See <i>Resetting the MC92N0-G</i> on page 2-24 for Windows devices and <i>Resetting the Android Device</i> on page 3-15 for Android devices.
	MC92N0-G removed from cradle while battery was charging.	Insert the MC92N0-G in cradle and begin charging. The lithium-ion battery requires less than four hours to recharge fully.
Cannot see characters on display.	MC92N0-G not powered on.	Press the Power button.
During data communication, no data was transmitted, or transmitted data was incomplete.	MC92N0-G removed from cradle or unplugged from host computer during communication.	Replace the MC92N0-G in the cradle, or reattach the Synchronization cable and re-transmit.
	Incorrect cable configuration.	See the System Administrator.
	Communication software was incorrectly installed or configured.	Perform setup. Refer to the <i>MC92N0-G Integrator Guide</i> for details. For Windows devices, ensure that Microsoft ActiveSync 4.5 or greater or Windows Mobile Device Center (WMDC) is installed on the host computer. For Android devices, ensure that MTP driver is installed.
No sound is audible.	Volume setting is low or turned off.	Adjust volume. See <i>Keypad Special Functions</i> on page B-20 for key combinations to increase or decrease the volume.

Table 8-1 Troubleshooting the MC92N0-G (Continued)



Problem	Cause	Solution
MC92N0-G turns itself off.	MC92N0-G is inactive.	<p>The MC92N0-G turns off after a period of inactivity.</p> <p>On Windows Embedded Handheld devices, check the power settings by tapping Start > Settings > System > Power > Advanced.</p> <p>On Windows CE devices, check the power settings by tapping Start > Settings > Control Panel > Power > Advanced.</p> <p>On Android devices, touch  > Display > Sleep.</p> <p>Change the setting if you need a longer delay before the automatic shutoff feature activates.</p>
	Battery is depleted.	Replace the battery.
Tapping the window buttons or icons does not activate the corresponding feature.	LCD screen not aligned correctly.	Re-calibrate the screen.
	The system is hung.	Warm boot the system. To perform a warm boot (see Resetting the MC92N0-G on page 2-24 for Windows devices and Resetting the Android Device on page 3-15 for Android devices).
A message appears stating that the MC92N0-G memory is full.	Too many files stored on the MC92N0-G.	Delete unused memos and records. You can save these records on the host computer.
	Too many applications installed on the MC92N0-G.	<p>If you have installed additional applications on the MC92N0-G, remove them to recover memory.</p> <p>On Windows Embedded Handheld devices, tap Start > Settings > System > Remove Programs.</p> <p>On Windows CE devices, tap Start > Settings > Control Panel > Remove Programs.</p> <p>Select the unused program and tap Remove.</p> <p>On Android devices, touch  > App > Downloaded. Select the unused downloaded application and touch Uninstall.</p>

Table 8-1 Troubleshooting the MC92N0-G (Continued)

Problem	Cause	Solution
The MC92N0-G does not accept scan input.	Scanning application is not loaded.	Verify that the unit is loaded with a scanning application. See <i>DataWedge on page 4-7</i> or the System Administrator.
	Unreadable bar code.	Ensure the symbol is not defaced.
	Distance between exit window and bar code is incorrect.	Ensure MC92N0-G is within proper scanning range.
	MC92N0-G is not programmed for the bar code.	Ensure the MC92N0-G is programmed to accept the type of bar code being scanned.
	MC92N0-G is not programmed to generate a beep.	If a beep on a good decode is expected and a beep is not heard, check that the application is set to generate a beep on good decode.
	Battery is low.	If the scanner stops emitting a laser beam when the trigger is pressed, check the battery level. When the battery is low, the scanner shuts off before the MC92N0-G low battery condition notification. Note: If the scanner is still not reading symbols, contact the distributor or Zebra.
WLAN connection is lost when the MC92N0-G is connected to a host computer using ActiveSync. (Windows devices only)	Microsoft security feature prevents connection to two separate networks.	Disconnect from the WLAN network prior to connecting to a host computer using ActiveSync.
MC92N0-G cannot find any Bluetooth devices nearby.	Too far from other Bluetooth devices.	Move closer to the other Bluetooth device(s), within a range of 10 meters.
	The Bluetooth device(s) nearby are not turned on.	Turn on the Bluetooth device(s) you wish to find.
	The Bluetooth device(s) are not in discoverable mode.	Set the Bluetooth device(s) to discoverable mode. If needed, refer to the device's user documentation for help.
MC92N0-G keeps powering down to protect memory contents.	The MC92N0-G's battery is low.	Recharge the battery.
Cannot extract Real-time data. (Windows devices only)	MC92N0-G is not responding.	Perform a warm boot then press F9 to extract data.

Four Slot Spare Battery Charger

Table 8-2 *Troubleshooting The Four Slot Spare Battery Charger*

Symptom	Possible Cause	Action
Batteries not charging.	Battery was removed from the charger or charger was unplugged from AC power too soon.	Ensure the charger is receiving power. Confirm main battery is charging. If a battery is fully depleted, it can take up to four hours to fully recharge a battery.
	Battery is faulty.	Verify that other batteries charge properly. If so, replace the faulty battery.
	Battery contacts not connected to charger.	Verify that the battery is seated in the battery well correctly with the contacts facing down.

Single Slot Serial/USB Cradle

Table 8-3 *Troubleshooting the Single Slot Serial/USB Cradle*

Symptom	Possible Cause	Solution
LEDs do not light when the MC92N0-G or spare battery is inserted.	Cradle is not receiving power.	Ensure the power cable is connected securely to both the cradle and to AC power.
	MC92N0-G is not seated firmly in the cradle.	Remove and re-insert the MC92N0-G into the cradle, ensuring it is firmly seated.
	Spare battery is not seated firmly in the cradle.	Remove and re-insert the spare battery into the charging slot, ensuring it is firmly seated.
MC92N0-G battery is not charging.	MC92N0-G was removed from cradle or cradle was unplugged from AC power too soon.	Ensure cradle is receiving power. Ensure the MC92N0-G is seated correctly. Confirm main battery is charging. If a MC92N0-G battery is fully depleted, it can take up to four hours to fully recharge a battery (if the MC92N0-G is off and longer if the MC92N0-G is operating). On Windows Embedded Handheld devices, view battery status by tapping Start > Settings > System > Power . On Windows CE devices, view battery status by tapping Start > Settings > Control Panel > Power . On Android devices, touch  > Battery .
	Battery is faulty.	Verify that other batteries charge properly. If so, replace the faulty battery.
	The MC92N0-G is not fully seated in the cradle.	Remove and re-insert the MC92N0-G into the cradle, ensuring it is firmly seated.

Table 8-3 Troubleshooting the Single Slot Serial/USB Cradle (Continued)

Symptom	Possible Cause	Solution
Spare battery is not charging.	Battery not fully seated in charging slot.	Remove and re-insert the spare battery into the cradle, ensuring it is firmly seated.
	Battery inserted incorrectly.	Ensure the contacts are facing down and toward the back of the cradle.
	Battery is faulty.	Verify that other batteries charge properly. If so, replace the faulty battery.
During data communications, no data was transmitted, or transmitted data was incomplete.	MC92N0-G removed from cradle during communications.	Replace the MC92N0-G in cradle and retransmit.
	Incorrect cable configuration.	See the System Administrator.
	Communications software is not installed or configured properly.	Perform setup as described in the <i>MC92N0-G Integrator Guide</i> . For Windows devices, ensure that Microsoft ActiveSync 4.5 or greater or WMDC is installed on the host computer. For Android devices, ensure that MTP driver is installed.

Cable Adapter Module

Table 8-4 Troubleshooting The Cable Adapter Module

Symptom	Possible Cause	Solution
MC92N0-G battery is not charging.	MC92N0-G was removed from CAM or CAM was unplugged from AC power too soon.	Ensure CAM is receiving power. Ensure the MC92N0-G is attached correctly. Confirm main battery is charging. If a MC92N0-G battery is fully depleted, it can take up to four hours to fully recharge a battery (if the MC92N0-G is off and longer if the MC92N0-G is operating). On Windows Embedded Handheld devices, view battery status by tapping Start > Settings > System > Power . On Windows CE devices, view battery status by tapping Start > Settings > Control Panel > Power . On Android devices, touch  > Battery .
	Battery is faulty.	Verify that other batteries charge properly. If so, replace the faulty battery.
	The MC92N0-G is not fully attached to the CAM.	Detach and re-attach the CAM to the MC92N0-G, ensuring it is firmly connected.

Table 8-4 *Troubleshooting The Cable Adapter Module (Continued)*

Symptom	Possible Cause	Solution
During data communications, no data was transmitted, or transmitted data was incomplete.	MC92N0-G detached from CAM during communications.	Re-attach the MC92N0-G to CAM and retransmit.
	Incorrect cable configuration.	See the System Administrator.
	Communications software is not installed or configured properly.	Perform setup as described in the <i>MC92N0-G Integrator Guide</i> .
		For Windows devices, ensure that Microsoft ActiveSync 4.5 or greater or WMDC is installed on the host computer. For Android devices, ensure that MTP driver is installed.
Android devices do not support serial communication.	Use USB communication.	

Magnetic Stripe Reader

Table 8-5 *Troubleshooting the Magnetic Stripe Reader*

Symptom	Possible Cause	Solution
MSR cannot read card.	MC92N0-G detached from MSR during card swipe.	Re-attach the MC92N0-G to MSR and reswipe the card.
	Faulty magnetic stripe on card.	See the System Administrator.
	MSR application is not installed or configured properly.	Ensure the MSR application is installed on the MC92N0-G. Ensure the MSR application is configured correctly.
MC92N0-G battery is not charging.	MC92N0-G was removed from MSR or MSR was unplugged from AC power too soon.	Ensure MSR is receiving power. Ensure the MC92N0-G is attached correctly. Confirm main battery is charging. If a MC92N0-G battery is fully depleted, it can take up to four hours to fully recharge a battery (if the MC92N0-G is off and longer if the MC92N0-G is operating). On Windows Embedded Handheld devices, view battery status by tapping Start > Settings > System > Power . On Windows CE devices, view battery status by tapping Start > Settings > Control Panel > Power .
		On Android devices, touch  > Battery .
	Battery is faulty.	Verify that other batteries charge properly. If so, replace the faulty battery.
The MC92N0-G is not fully attached to the MSR.	Detach and re-attach the MSR to the MC92N0-G, ensuring it is firmly connected.	

Table 8-5 *Troubleshooting the Magnetic Stripe Reader (Continued)*

Symptom	Possible Cause	Solution
During data communications, no data was transmitted, or transmitted data was incomplete.	MC92N0-G detached from MSR during communications.	Reattach the MC92N0-G to MSR and retransmit.
	Incorrect cable configuration.	See the System Administrator.
	Communications software is not installed or configured properly.	Perform setup as described in the <i>MC92N0-G Integrator Guide</i> .
	Android devices do not support serial communication.	Use USB communication.

APPENDIX A SPECIFICATIONS

Technical Specifications

The following tables summarize the MC92N0-G's intended operating environment and general technical hardware specifications.

MC92N0-G

The following table summarizes the MC92N0-G's intended operating environment.

Table A-1 *Technical Specifications*

Item	Description
Physical and Environmental Characteristics	
Dimensions	23.1 cm L x 9.1 cm H x 19.3 cm H 9.1 in. L x 3.6 in. W x 7.6 in. H
Weight	765 g (27 oz.)
Keyboard	28-key; 43-key; 53-key; High Visibility and Terminal Emulation (5250, 3270, VT)
Display	16 bit color 3.7 in with backlight, 65K colors. QVGA Mode: 240 W x 320 L (Windows CE only) VGA Mode: 480 W x 640 L.
Power	Removable, rechargeable 7.4 V Lithium Ion 2600 mAh battery pack, 19.3 watt hours
Performance Characteristics	
CPU	Texas Instruments OMAP 4430 processor at 1GHz
Operating System	Microsoft Windows Embedded Compact 7.0 (Windows CE 7.0) Microsoft Windows Embedded Handheld Android-based Android Open Source Project (AOSP) version 4.4.4.

Table A-1 *Technical Specifications (Continued)*

Item	Description
Memory	Standard: 512 MB RAM/2 GB FLASH (Windows only) Premium: 1GB RAM/2 GB FLASH
Expansion	SD Card (up to 32 GB)
Application Development	For Windows development, PSDK and EMDK or for Android development, Android EMDK. Available through Zebra Support Central Web site.
Data Capture Options	<p>SE965: 1D standard range scan engine.</p> <p>SE1524-ER: 1D extended range scan engine (Windows only).</p> <p>SE4600-LR: Extended range omnidirectional 1D/2D imaging engine reads 1D and 2D symbols (Windows only).</p> <p>SE4500-SR: Omnidirectional 1D/2D imaging engine reads 1D and 2D symbols.</p> <p>SE4500-DL: 1D/2D DL imaging engine reads all 1D and 2D codes as well as the PDF codes found on driver's licenses and other identification documents (Windows Premium only).</p> <p>SE4500-HD: 1D/2D DPM imaging engine reads a wide variety of DPM marks on metal, plastic and glass surfaces, including: dot peening, laser etching, molding, stamping or casting (Windows Premium only).</p> <p>SE4750-SR: Standard Range omnidirectional 1D/2D imaging engine reads 1D and 2D symbols. (Premium only).</p> <p>SE4750-MR: Mid-Range omnidirectional 1D/2D imaging engine reads 1D and 2D symbols. (Premium only).</p> <p>SE4850-ER: Extended range omnidirectional 1D/2D imaging engine reads 1D and 2D symbols.</p>
Voice and Audio	High quality speaker and 2.5mm headset jack.
User Environment	
Operating Temperature	-4 °F to 122 °F (-20 °C to 50 °C)
Storage Temperature	-22 °F to 140 °F (-30 °C to 60 °C)
Battery Charging Temperature	32 °F to 104 °F (0 °C to +40 °C)
Humidity	5% to 95% non condensing
Drop Specification	Multiple drops to concrete: 6 ft./1.8 m across the operating temperature range; meets and exceeds MIL-STD 810G, 8 ft./2.4 m drop at room temperature per MIL-STD810G.
Tumble	2,000 one-meter tumbles at room temperature (4,000 hits) per IEC Tumble Specification
Environmental Sealing	IP64 (electronic enclosure, display and keypad) per IEC Sealing Specification

Table A-1 *Technical Specifications (Continued)*

Item	Description
ESD	+/-15kVdc air discharge +/-8kVdc direct discharge +/-8kVdc indirect discharge
WLAN Wireless Data Communications	
WLAN radio	802.11a/b/g/n
Output Power	100mW U.S. and International
Data Rate	802.11a: up to 54Mb per second 802.11b: up to 11Mb per second 802.11g: up to 54Mb per second 802.11n: up to 72.2Mb per second
Frequency Range	All country dependent: 802.11a - 5 GHz; 802.11b – 2.4 GHz; 802.11g – 2.4 GHz; 802.11n – 2.4 GHz / 5 GHz
Antenna	Internal diversity antenna
WLAN Security	WPA2 Enterprise, 802.1x; EAP-TLS; TTLS (CHAP, MS-CHAP, MS-CHAPv2, PAP or MD5); PEAP (TLS, MSCHAPv2, EAP-GTC); LEAP, EAP-FAST (TLS, MS-CHAPv2, EAP-GTC), WPA2/AES, CCX v4, FIPS 140-2 compliant and IPv6
WPAN Wireless Data Communications	
Bluetooth	Windows devices with Microsoft Bluetooth Stack: Bluetooth Version 2.1 with EDR Windows devices with StoneStreet One Bluetooth Stack: Bluetooth Version 4.0 with Low Energy Android devices: Bluetooth Version 4.0 with Low Energy
Peripherals and Accessories	
Cradles	Single-slot serial/USB, 4-slot Ethernet, 4-slot charge only and forklift
Printers	Supports extensive line of Zebra approved printers
Charger	4-slot battery charger, 4-slot universal battery charger
Other Accessories	Cable Adapter Module; full set of holsters; Keypad Module; full set of stylus; full set of cables; Zebra approved CAC Reader for government applications; GSM, Rugged and Cabled Headset

Table A-2 *Data Capture Options*

Item	Description
Laser Decode Capability	Code 39, Code 128, Code 93, Codabar, Code 11, Discrete 2 of 5, Interleaved 2 of 5, EAN-8, EAN-13, MSI, UPCA, UPCE, UPC/EAN supplementals, Coupon Code, Trioptic 39, Webcode, RSS-14, RSS Limited, RSS Expanded, Chinese 2 of 5
Imaging Decode Capability	Code 39, Code 128, Code 93, Codabar, Code 11, Interleaved 2 of 5, Discrete 2 of 5, MSI, EAN-8, EAN-13, UPCA, UPCE, UPC/EAN supplementals, Coupon Code, Trioptic 39, Webcode, TLC39, Composite AB, Composite C, Micro PDF-417, PDF-417, Macro PDF-417, (Macro) Micro PDF-417, QR Code, RSS Expanded, RSS Limited, RSS-14, Data Matrix, Maxi Code, US Postnet, US Planet, UK 4-state, Australian 4-state, Canadian 4-state, Japanese 4-state, Dutch Kix, Chinese 2 of 5, USPS 4-state (US4CB), Aztec, microQR

APPENDIX B KEYPADS

Introduction

The MC92N0-G has the following interchangeable modular keypads:

- 28-key keypad
- 43-key keypad
- 53-key keypad/53-key High Visibility keypad
- 3270 Emulator
- 5250 Emulator
- VT Emulator.

The modular keypads can be changed in the field, as necessary, to support specialized applications. Refer to the *MC92N0-G Integrator Guide* for installation and removal procedures.

28-Key Keypad

The 28-key keypad contains a **Power** button, application keys, scroll keys and function keys. The keypad is color-coded to indicate the alternate function key (blue) values. Note that keypad functions can be changed by an application so the MC92N0-G's keypad may not function exactly as described. See [Table B-1 on page B-3](#) for key and button descriptions and [Table B-7 on page B-26](#) for the keypad's special functions.

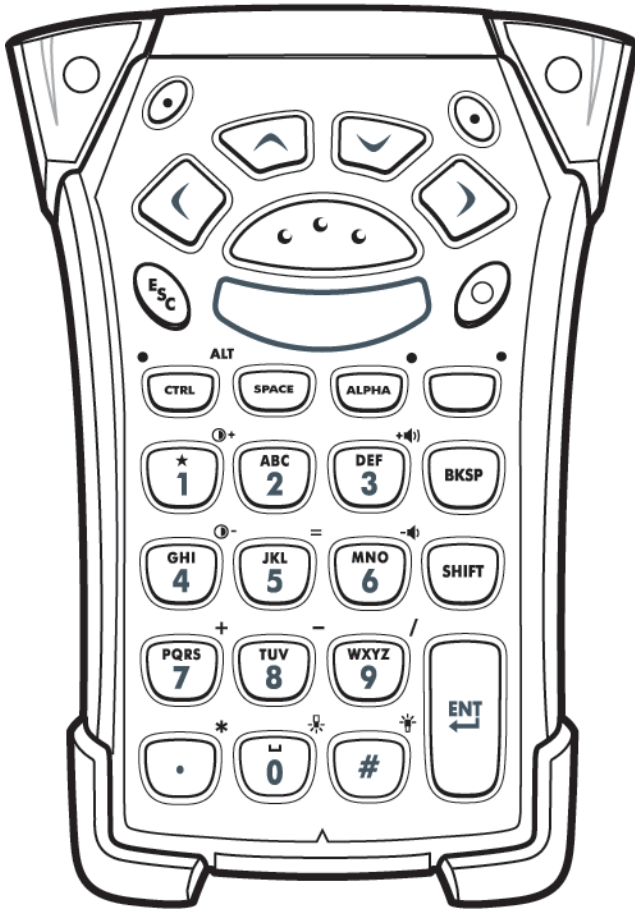

Figure B-1 28-Key Keypad

Table B-1 28-Key Descriptions







Key	Description
Power (red) 	Turns the MC92N0-G on and off. Performs a warm boot and a cold boot. See <i>Resetting the MC92N0-G on page 2-24</i> for Windows devices and <i>Resetting the Android Device on page 3-15</i> for Android devices for information about performing a warm and cold boot.
Green/Red Dot 	To use a key as an application key (APP key) on the keyboard, a new keyboard remap table must be created and installed. However, the Green/Red dot keys can be remapped as APP keys through the registry. Create an XML Provisioning file with the following entries: Characteristic type = "HKEY_LOCAL_MACHINE\HARDWARE\DEVICEMAP\KEYBD" Parm name = "GreenKeyOverride" value = "xx", where xx is the new APP key code. Parm name = "RedKeyOverride" value = "xx", where xx is the new APP key code. Refer to the <i>MC92N0-G Integrator Guide</i> for instruction on updating the registry using XML Provisioning. This sends an APP key code, instead of their original key codes, when the green or red dot key is pressed.
Scan (yellow) 	Activates the scanner/imager in a scan enabled application.
Scroll Up and Down 	Moves up and down from one item to another. Increases/decreases specified values.
Scroll Left and Right 	Moves left and right from one item to another. Increases/decreases specified values.
ESC 	Exits the current operation.
One/Star 	Produces the number one in default state. Produces an asterisk in Alpha state.

Table B-1 28-Key Descriptions (Continued)



















Key	Description
<p>Alphanumeric</p> 	<p>In default state, produces the numeric value on the key.</p> <p>In Alpha state, produces the lower case alphabetic characters on the key. Each key press produces the next alphabetic character in sequence. For example, press and release the ALPHA key and then press the '4' key once to produce the letter 'g'; press and release the ALPHA key and then press the '4' key three times to produce the letter 'i'.</p> <p>When the SHIFT key is pressed in Alpha state, the upper case alphabetic characters on the key are produced. For example, press and release the ALPHA key, press and release the SHIFT key and then press the '4' key once to produce the letter 'G'; press and release the SHIFT key and then press the '4' key three times to produce the letter 'I'.</p>
<p>SPACE/BKSP</p> 	<p>Space and backspace functions.</p>
<p>CTRL (Control)</p> 	<p>Press and release the CTRL key to activate the keypad alternate CTRL functions. The LED above the key lights and the  icon appears at the bottom of the screen on Windows Mobile and Windows CE devices and the  icon appears in the status bar on Android devices.</p> <p>Press the Blue key followed by the CTRL key to activate the keypad alternate ALT functions. The ALT icon appears at the bottom of the screen on Windows Mobile and Windows CE devices and the  icon appears in the status bar on Android devices.</p>
<p>ALPHA</p> 	<p>The default keypad mode is the num-lock (number lock) mode. Press the orange ALPHA key to de-activate the num-lock mode and to access the alternate ALPHA characters (shown on the keypad in orange). The LED above the key lights. The  icon appears in the status bar on Android devices. Press and release the ALPHA key again to return to the normal keypad functions.</p>
<p>Function (blue)</p> 	<p>Press and release the blue function key to activate the keypad alternate functions (shown on the keypad in blue). The LED above the key lights and the  icon appears on the bottom of the screen on Windows Mobile and Windows CE devices and the  icon appears in the status bar on Android devices. Press and release the blue function key again to return to the normal keypad functions.</p>
<p>SHIFT</p> 	<p>Press and release the SHIFT key to activate the keypad alternate SHIFT functions. The  icon appears on the bottom of the screen on Windows Mobile and Windows CE devices and the  icon appears in the status bar on Android devices. After pressing another key, the keypad returns to the non-shift state. Refer to the MC92N0-G Integrator Guide for instructions to set the Shift key to enable the Shift Lock state.</p>
<p>ENT (Enter)</p> 	<p>Executes a selected item or function.</p>

Table B-1 28-Key Descriptions (Continued)

Key	Description
Period/Decimal Point 	In default state, produces a period for alpha entries and a decimal point for numeric entries. In function key state, produces an asterisk. When the SHIFT key is pressed in function key state, produces an asterisk.
Zero 	In default state, produces a zero. In Alpha state, produces a space.
Pound 	Produces a pound/number sign.

43-Key Keypad

The 43-key keypad contains a **Power** button, application keys, scroll keys and a function key. The keypad is color-coded to indicate the alternate function key (blue) values and the alternate ALPHA key (orange) values. Note that keypad functions can be changed by an application so the MC92N0-G's keypad may not function exactly as described. See [Table B-2 on page B-7](#) for key and button descriptions and [Table B-7 on page B-26](#) for the keypad's special functions.

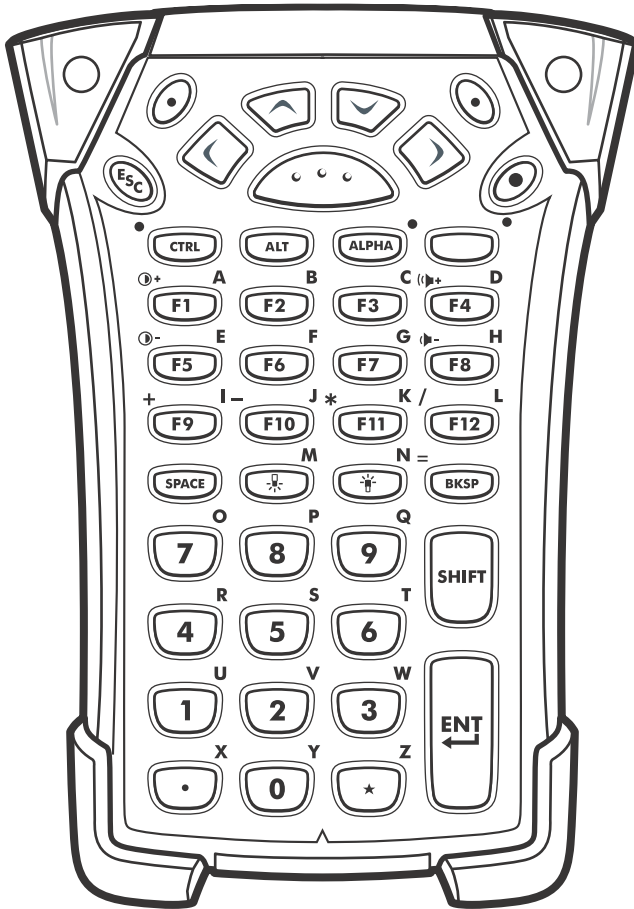

Figure B-2 43-Key Keypad

Table B-2 43-Key Keypad Descriptions









Key	Description
Power (red) 	Turns the MC92N0-G on and off. Performs a warm boot and a cold boot. See <i>Resetting the MC92N0-G on page 2-24</i> for Windows devices and <i>Resetting the Android Device on page 3-15</i> for Android devices for information about performing a warm and cold boot.
Green/Red Dot 	To use a key as an application key (APP key) on the keyboard, a new keyboard remap table must be created and installed. However, the Green/Red dot keys can be remapped as APP keys through the registry. Create an XML Provisioning file with the following entries: Characteristic type = "HKEY_LOCAL_MACHINE\HARDWARE\DEVICEMAP\KEYBD" Parm name = "GreenKeyOverride" value = "xx", where xx is the new APP key code. Parm name = "RedKeyOverride" value = "xx", where xx is the new APP key code. Refer to the <i>MC92N0-G Integrator Guide</i> for instruction on updating the registry using XML Provisioning. This sends an APP key code, instead of their original key codes, when the green or red dot key is pressed.
Scan (yellow) 	Activates the scanner/imager in a scan enabled application.
Scroll Up and Down 	Moves up and down from one item to another. Increases/decreases specified values.
Scroll Left and Right 	Moves left and right from one item to another. Increases/decreases specified values.
ESC 	Exits the current operation.
SPACE/BKSP 	Space and backspace functions.
Numeric/Alpha 	Number or alpha value depending on the state of the ALPHA key.

Table B-2 43-Key Keypad Descriptions (Continued)















Key	Description
<p>Alpha/Application</p> 	<p>These keys can have an application assigned to the function value and have an alpha value assigned when used with the ALPHA function key.</p> <p>On Windows Embedded Handheld devices: F6 and F7 keys cannot be remapped and are dedicated by the Operating System to control volume level. When these keys are pressed, Shell.exe traps them and displays the volume adjustment window. To get these keys to an application, call GXOpenInput() at the beginning of the application and call GXCloseInput() at the end of the application. This redirects all of the key events to an application, including the F6 and F7 keys.</p> <p>Note: Other applications cannot receive any key event until GXCloseInput() is called. For example, if the customer is using the APP1 key to run Calc.exe, this is disabled during this period.</p>
<p>Function (blue)</p> 	<p>Press and release the blue function key to activate the keypad alternate functions (shown on the keypad in blue). The LED above the key lights and the  icon appears at the bottom of the screen on Windows Mobile and Windows CE devices and the  icon appears in the status bar on Android devices. Press and release the blue function key again to return to the normal keypad functions.</p>
<p>Control</p> 	<p>Press and release the CTRL key to activate the keypad alternate CTRL functions. The LED above the key lights and the  icon appears at the bottom of the screen on Windows Mobile and Windows CE devices and the  icon appears in the status bar on Android devices.</p>
<p>ALT</p> 	<p>Press the ALT key to activate the keypad alternate ALT functions. The ALT icon appears at the bottom of the screen on Windows Mobile and Windows CE devices and the  icon appears in the status bar on Android devices.</p>
<p>ALPHA (orange)</p> 	<p>The default keypad mode is the num-lock (number lock) mode. Press the orange ALPHA key to de-activate the num-lock mode and to access the alternate ALPHA characters (shown on the keypad in orange). The LED above the key lights. The  icon appears in the status bar on Android devices. Press and release the ALPHA key again to return to the normal keypad functions.</p>
<p>Shift</p> 	<p>Changes the state of the alpha characters from lowercase to uppercase. Press the SHIFT key to activate this mode temporarily, followed by another key. The  icon appears at the bottom of the screen on Windows Mobile and Windows CE devices and the  icon appears in the status bar on Android devices.</p> <p>On Android devices, press and release the SHIFT key twice to enable the Shift Lock state. The  icon appears in the status bar. Press and release the SHIFT key again to disable the Shift Lock state.</p> <p>On Windows devices, refer to the <i>MC92N0-G Integrator Guide</i> for instructions to set the Shift key to enable the Shift Lock state.</p>

Table B-2 43-Key Keypad Descriptions (Continued)



Key	Description
Period/Decimal Point 	Produces a period for alpha entries, a decimal point for numeric entries and the alphabetic character X when the ALPHA function key is activated.
Star 	Produces an asterisk and the alphabetic character Z when the ALPHA function key is activated.
Enter 	Executes a selected item or function.

Table B-3 53-Key Descriptions









Key	Description
Power (red) 	Turns the MC92N0-G on and off. Performs a warm boot and a cold boot. See <i>Resetting the MC92N0-G on page 2-24</i> for Windows devices and <i>Resetting the Android Device on page 3-15</i> for Android devices for information about performing a warm and cold boot.
Green/Red Dot 	To use a key as an application key (APP key) on the keyboard, a new keyboard remap table must be created and installed. However, the Green/Red dot keys can be remapped as APP keys through the registry. Create an XML Provisioning file with the following entries: Characteristic type = "HKEY_LOCAL_MACHINE\HARDWARE\DEVICEMAP\KEYBD" Parm name = "GreenKeyOverride" value = "xx", where xx is the new APP key code. Parm name = "RedKeyOverride" value = "xx", where xx is the new APP key code. Refer to the <i>MC92N0-G Integrator Guide</i> for instruction on updating the registry using XML Provisioning. This sends an APP key code, instead of their original key codes, when the green or red dot key is pressed.
Scan (yellow) 	Activates the scanner/imager in a scan enabled application.
Scroll Up and Down 	Moves up and down from one item to another. Increases/decreases specified values.
Scroll Left and Right 	Moves left and right from one item to another. Increases/decreases specified values.
ESC 	Exits the current operation.
Alpha 	Use the alpha keys for alphabetic characters.
SPACE/BKSP 	Space and backspace functions.

Table B-3 53-Key Descriptions (Continued)















Key	Description
<p>Numeric/Application</p> 	<p>Numeric value keys - can have applications assigned with function key(s).</p> <p>For Windows Embedded Handheld devices: F6 and F7 keys cannot be remapped and are dedicated by the Operating System to control volume level. When these keys are pressed, Shell.exe traps them and displays the volume adjustment window. To get these keys to an application, call GXOpenInput() at the beginning of the application and call GXCloseInput() at the end of the application. This redirects all of the key events to an application, including the F6 and F7 keys.</p> <p>Note: Other applications cannot receive any key event until GXCloseInput() is called. For example, if the customer is using the APP1 key to run Calc.exe, this is disabled during this period.</p>
<p>Function (blue)</p> 	<p>Press and release the blue function key to activate the keypad alternate functions (shown on the keypad in blue). The LED above the key lights and the  icon appears at the bottom of the screen on Windows Mobile and Windows CE devices and the  icon appears in the status bar on Android devices. Press and release the blue function key again to return to the normal keypad functions.</p>
<p>Control</p> 	<p>Press and release the CTRL key to activate the keypad alternate CTRL functions. The LED above the key lights and the  icon appears at the bottom of the screen on Windows Mobile and Windows CE devices and the  icon appears in the status bar on Android devices.</p> <p>Press the Blue key followed by the CTRL key to activate the keypad alternate ALT functions. The ALT icon appears on the bottom of the screen on Windows Mobile and Windows CE devices and the  icon appears in the status bar on Android devices.</p>
<p>Shift</p> 	<p>Press and release the SHIFT key to activate the keypad alternate SHIFT functions. The  icon appears on the bottom of the screen on Windows Mobile and Windows CE devices and the  icon appears in the status bar on Android devices. After pressing another key, the keypad returns to the non-shift state.</p> <p>On Android devices, press and release the SHIFT key twice to enable the Shift Lock state. The  icon appears in the status bar. Press and release the SHIFT key again to disable the Shift Lock state.</p> <p>On Windows devices, refer to the MC92N0-G Integrator Guide for instructions to set the Shift key to enable the Shift Lock state.</p>

Table B-3 53-Key Descriptions (Continued)

Key	Description
Period/Decimal Point 	Produces a period for alpha entries and a decimal point for numeric entries.
Star 	Produces an asterisk.
Enter 	Executes a selected item or function.

3270 Emulator Keypad

There are two physical configurations of the 3270 emulator keypad, however both of the keypads are functionally identical. The 3270 emulator keypad contains a Power button, application keys, scroll keys and a function key. The keypad is color-coded to indicate the alternate function key (blue) values. Note that keypad functions can be changed by an application so the MC92N0-G's keypad may not function exactly as described. See [Table B-4 on page B-15](#) for key and button descriptions and [Table B-7 on page B-26](#) for the keypad's special functions.

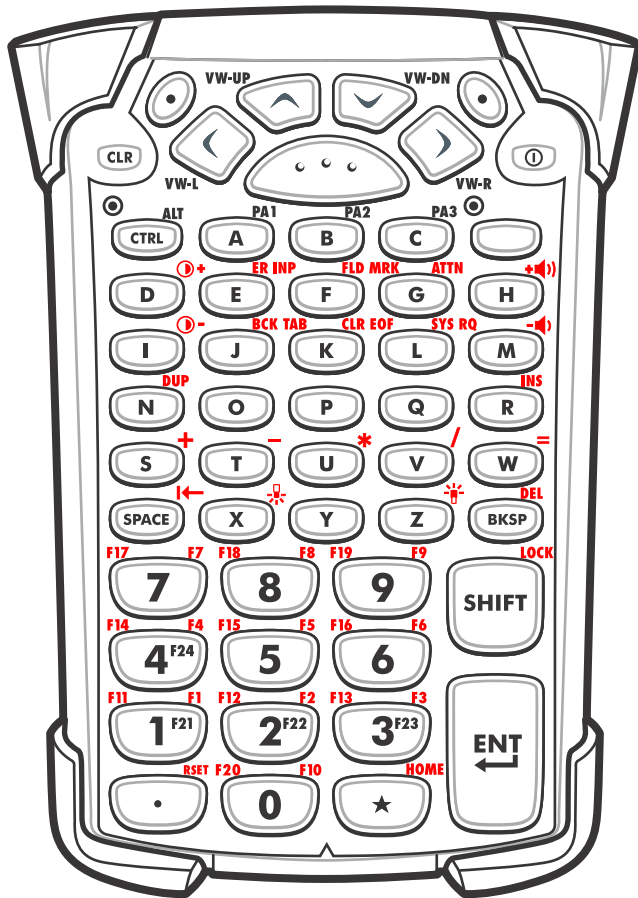

Figure B-4 3270 Emulator Keypad

✓ **NOTE** The 3270 emulator keypad is only used when the MC92N0-G is running the 3270 emulation software. On Windows devices, when the MC92N0-G is not running the 3270 emulation software, the 3270 keypad functions are the same as a 53-key keypad.

Table B-4 3270 Emulator Descriptions









Key	Description
Power (red) 	Turns the MC92N0-G on and off. Performs a warm boot and a cold boot. See <i>Resetting the MC92N0-G on page 2-24</i> for Windows devices and <i>Resetting the Android Device on page 3-15</i> for Android devices for information about performing a warm and cold boot.
Green/Red Dot 	To use a key as an application key (APP key) on the keyboard, a new keyboard remap table must be created and installed. However, the Green/Red dot keys can be remapped as APP keys through the registry. Create an XML Provisioning file with the following entries: Characteristic type = "HKEY_LOCAL_MACHINE\HARDWARE\DEVICEMAP\KEYBD" Parm name = "GreenKeyOverride" value = "xx", where xx is the new APP key code. Parm name = "RedKeyOverride" value = "xx", where xx is the new APP key code. Refer to the <i>MC92N0-G Integrator Guide</i> for instruction on updating the registry using XML Provisioning. This sends an APP key code, instead of their original key codes, when the green or red dot key is pressed.
Scan (yellow) 	Activates the scanner/imager in a scan enabled application.
Scroll Up and Down 	Moves up and down from one item to another. Increases/decreases specified values.
Scroll Left and Right 	Moves left and right from one item to another. Increases/decreases specified values.
CLR 	Exits the current operation.
Alpha 	Use the alpha keys for alphabetic characters.
SPACE/BKSP 	Space and backspace functions.

Table B-4 3270 Emulator Descriptions (Continued)















Key	Description
<p>Application</p> 	<p>These keys can be assigned to an application.</p> <p>On Windows Embedded Handheld devices: F6 and F7 keys cannot be remapped and are dedicated by the Operating System to control volume level. When these keys are pressed, Shell.exe traps them and displays the volume adjustment window. To get these keys to an application, call GXOpenInput() at the beginning of the application and call GXCLOSEInput() at the end of the application. This redirects all of the key events to an application, including the F6 and F7 keys.</p> <p>Note: Other applications cannot receive any key event until GXCLOSEInput() is called. For example, if the customer is using the APP1 key to run Calc.exe, this is disabled during this period.</p>
<p>Function (blue)</p> 	<p>Press and release the blue function key to activate the keypad alternate functions (shown on the keypad in blue). The LED above the key lights and the  icon appears at the bottom of the screen on Windows Mobile and Windows CE devices and the  icon appears in the status bar on Android devices. Press and release the blue function key again to return to the normal keypad functions.</p>
<p>Control</p> 	<p>Press and release the CTRL key to activate the keypad alternate CTRL functions. The LED above the key lights and the  icon appears at the bottom of the screen on Windows Mobile and Windows CE devices and the  icon appears in the status bar on Android devices.</p> <p>Press the Blue key followed by the CTRL key to activate the keypad alternate ALT functions. The ALT icon appears on the bottom of the screen on Windows Mobile and Windows CE devices and the  icon appears in the status bar on Android devices.</p>
<p>Shift</p> 	<p>Press and release the SHIFT key to activate the keypad alternate SHIFT functions. The  icon appears on the bottom of the screen on Windows Mobile and Windows CE devices and the  icon appears in the status bar on Android devices. After pressing another key, the keypad returns to the non-shift state.</p> <p>On Android devices, press and release the SHIFT key twice to enable the Shift Lock state. The  icon appears in the status bar. Press and release the SHIFT key again to disable the Shift Lock state.</p> <p>On Windows devices, refer to the MC92N0-G Integrator Guide for instructions to set the Shift key to enable the Shift Lock state.</p>

Table B-4 3270 Emulator Descriptions (Continued)

Key	Description
Period/Decimal Point 	Produces a period for alpha entries and a decimal point for numeric entries.
Star 	Produces an asterisk.
Enter 	Executes a selected item or function.

5250 Emulator Keypad

There are two physical configurations of the 5250 emulator keypad, however both of the keypads are functionally identical. The 5250 emulator keypad contains a Power button, application keys, scroll keys and a function key. The keypad is color-coded to indicate the alternate function key (blue) values. Note that keypad functions can be changed by an application so the MC92N0-G's keypad may not function exactly as described. See [Table B-5 on page B-19](#) for key and button descriptions and [Table B-7 on page B-26](#) for the keypad's special functions.

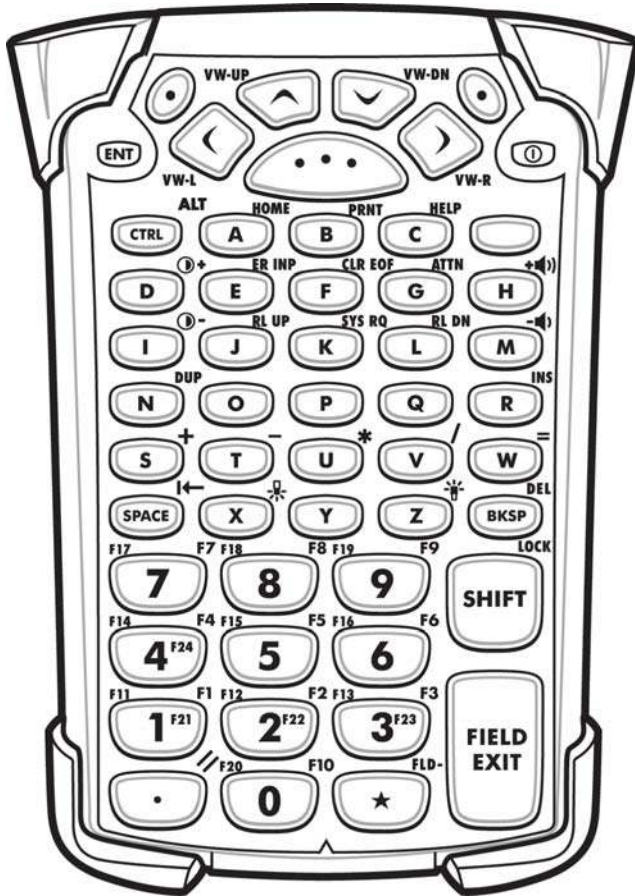

Figure B-5 5250 Emulator Keypad

- ✓ **NOTE** The 5250 emulator configuration is only used when the MC92N0-G is running the 5250 emulation software. On Windows devices, when the MC92N0-G is not running the 5250 emulation software, the 5250 keypad functions are the same as a 53-key keypad.

Table B-5 5250 Emulator Descriptions









Key	Description
Power (red) 	Turns the MC92N0-G on and off. Performs a warm boot and a cold boot. See <i>Resetting the MC92N0-G on page 2-24</i> for Windows devices and <i>Resetting the Android Device on page 3-15</i> for Android devices for information about performing a warm and cold boot.
Green/Red Dot 	To use a key as an application key (APP key) on the keyboard, a new keyboard remap table must be created and installed. However, the Green/Red dot keys can be remapped as APP keys through the registry. Create an XML Provisioning file with the following entries: Characteristic type = "HKEY_LOCAL_MACHINE\HARDWARE\DEVICEMAP\KEYBD" Parm name = "GreenKeyOverride" value = "xx", where xx is the new APP key code. Parm name = "RedKeyOverride" value = "xx", where xx is the new APP key code. Refer to the <i>MC92N0-G Integrator Guide</i> for instruction on updating the registry using XML Provisioning. This sends an APP key code, instead of their original key codes, when the green or red dot key is pressed.
Scan (yellow) 	Activates the scanner/imager in a scan enabled application.
Scroll Up and Down 	Moves up and down from one item to another.
Scroll Left and Right 	Moves left and right from one item to another.
ENT 	Exits the current operation.
Alpha 	Use the alpha keys for alphabetic characters.
SPACE/BKSP 	Space and backspace functions.

Table B-5 5250 Emulator Descriptions (Continued)















Key	Description
<p>Application</p> 	<p>These keys can be assigned to an application.</p> <p>On Windows Embedded Handheld devices: F6 and F7 keys cannot be remapped and are dedicated by the Operating System to control volume level. When these keys are pressed, Shell.exe traps them and displays the volume adjustment window. To get these keys to an application, call GXOpenInput() at the beginning of the application and call GXCloseInput() at the end of the application. This redirects all of the key events to an application, including the F6 and F7 keys.</p> <p>Note: Other applications cannot receive any key event until GXCloseInput() is called. For example, if the customer is using the APP1 key to run Calc.exe, this is disabled during this period.</p>
<p>Function (blue)</p> 	<p>Press and release the blue function key to activate the keypad alternate functions (shown on the keypad in blue). The LED above the key lights and the  icon appears at the bottom of the screen on Windows Mobile and Windows CE devices and the  icon appears in the status bar on Android devices. Press and release the blue function key again to return to the normal keypad functions.</p>
<p>Control</p> 	<p>Press and release the CTRL key to activate the keypad alternate CTRL functions. The LED above the key lights and the  icon appears at the bottom of the screen on Windows Mobile and Windows CE devices and the  icon appears in the status bar on Android devices.</p> <p>Press the Blue key followed by the CTRL key to activate the keypad alternate ALT functions. The ALT icon appears on the bottom of the screen on Windows Mobile and Windows CE devices and the  icon appears in the status bar on Android devices.</p>
<p>Shift</p> 	<p>Press and release the SHIFT key to activate the keypad alternate SHIFT functions. The  icon appears on the bottom of the screen on Windows Mobile and Windows CE devices and the  icon appears in the status bar on Android devices. After pressing another key, the keypad returns to the non-shift state.</p> <p>On Android devices, press and release the SHIFT key twice to enable the Shift Lock state. The  icon appears in the status bar. Press and release the SHIFT key again to disable the Shift Lock state.</p> <p>On Windows devices, refer to the <i>MC92N0-G Integrator Guide</i> for instructions to set the Shift key to enable the Shift Lock state.</p>

Table B-5 5250 Emulator Descriptions (Continued)

Key	Description
Period/Decimal Point 	Produces a period for alpha entries and a decimal point for numeric entries.
Star 	Produces an asterisk.
Enter 	Executes a selected item or function.

VT Emulator Keypad

The VT emulator keypad contains a Power button, application keys, scroll keys and a function key. The keypad is color-coded to indicate the alternate function key (blue) values. Note that keypad functions can be changed by an application so the MC92N0-G's keypad may not function exactly as described. See [Table B-6 on page B-23](#) for key and button descriptions and [Table B-7 on page B-26](#) for the keypad's special functions.

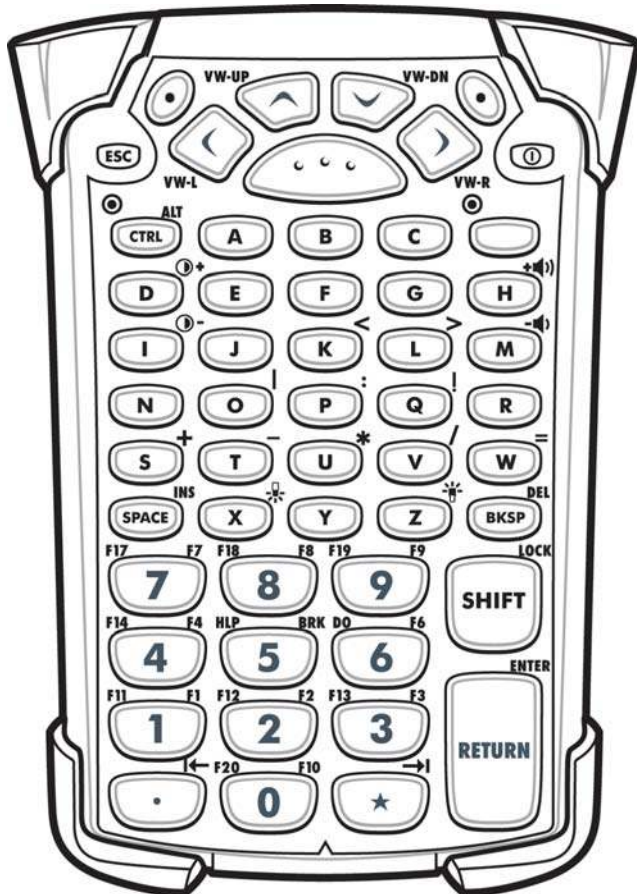

Figure B-6 VT Emulator Keypad

- ✓ **NOTE** The VT emulator configuration is only used when the MC92N0-G is running the VT emulation software. On Windows devices, when the MC92N0-G is not running the VT emulation software, the VT keypad functions are the same as a 53-key keypad.

Table B-6 VT Emulator Descriptions







Key	Description
Power (red) 	Turns the MC92N0-G on and off. Performs a warm boot and a cold boot. See <i>Resetting the MC92N0-G on page 2-24</i> for Windows devices and <i>Resetting the Android Device on page 3-15</i> for Android devices for information about performing a warm and cold boot.
Green/Red Dot 	To use a key as an application key (APP key) on the keyboard, a new keyboard remap table must be created and installed. However, the Green/Red dot keys can be remapped as APP keys through the registry. Create an XML Provisioning file with the following entries: Characteristic type = "HKEY_LOCAL_MACHINE\HARDWARE\DEVICEMAP\KEYBD" Parm name = "GreenKeyOverride" value = "xx", where xx is the new APP key code. Parm name = "RedKeyOverride" value = "xx", where xx is the new APP key code. Refer to the <i>MC92N0-G Integrator Guide</i> for instruction on updating the registry using XML Provisioning. This sends an APP key code, instead of their original key codes, when the green or red dot key is pressed.
Scan (yellow) 	Activates the scanner/imager in a scan enabled application.
Scroll Up and Down 	Moves up and down from one item to another.
Scroll Left and Right 	Moves left and right from one item to another.
ESC 	Exits the current operation.
Alpha 	Use the alpha keys for alphabetic characters.
SPACE/BKSP 	Space and backspace functions.

Table B-6 VT Emulator Descriptions (Continued)







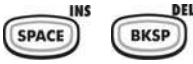





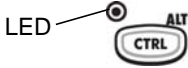

Key	Description
<p>Application</p> 	<p>These keys can be assigned to an application.</p> <p>On Windows Embedded Handheld devices: F6 and F7 keys cannot be remapped and are dedicated by the Operating System to control volume level. When these keys are pressed, Shell.exe traps them and displays the volume adjustment window. To get these keys to an application, call GXOpenInput() at the beginning of the application and call GXCloseInput() at the end of the application. This redirects all of the key events to an application, including the F6 and F7 keys.</p> <p>Note: Other applications cannot receive any key event until GXCloseInput() is called. For example, if the customer is using the APP1 key to run Calc.exe, this is disabled during this period.</p>
<p>Function (blue)</p> 	<p>Press and release the blue function key to activate the keypad alternate functions (shown on the keypad in blue). The LED above the key lights and the  icon appears at the bottom of the screen on Windows Mobile and Windows CE devices and the  icon appears in the status bar on Android devices. Press and release the blue function key again to return to the normal keypad functions.</p>
<p>Control</p> 	<p>Press and release the CTRL key to activate the keypad alternate CTRL functions. The LED above the key lights and the  icon appears at the bottom of the screen on Windows Mobile and Windows CE devices and the  icon appears in the status bar on Android devices.</p> <p>Press the Blue key followed by the CTRL key to activate the keypad alternate ALT functions. The ALT icon appears on the bottom of the screen on Windows Mobile and Windows CE devices and the  icon appears in the status bar on Android devices.</p>
<p>Shift</p> 	<p>Press and release the SHIFT key to activate the keypad alternate SHIFT functions. The  icon appears on the bottom of the screen on Windows Mobile and Windows CE devices and the  icon appears in the status bar on Android devices. After pressing another key, the keypad returns to the non-shift state.</p> <p>On Android devices, press and release the SHIFT key twice to enable the Shift Lock state. The  icon appears in the status bar. Press and release the SHIFT key again to disable the Shift Lock state.</p> <p>On Windows devices, refer to the <i>MC92N0-G Integrator Guide</i> for instructions to set the Shift key to enable the Shift Lock state.</p>







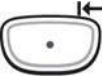
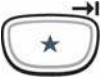

Table B-6 VT Emulator Descriptions (Continued)

Key	Description
Period/Decimal Point 	Produces a period for alpha entries and decimal point for numeric entries.
Star 	Produces an asterisk.
Enter 	Executes a selected item or function.

Keypad Special Functions

The keypad special functions are color coded on the keypads. For example, on the 53-key keypad, the display backlight icon is blue indicating that the blue function key must be selected first to access the display backlight. On the 43-key keypad, the display backlight icon is white indicating that the display backlight is the default value for that key.

Table B-7 Keypad Special Functions

Icon	28-Key Keypad	43-Key Keypad	53-Key, 3270, 5250, VT Keypad	Special Function
	Blue key + #	 key	Blue key + Z	Turns on and off the display backlight.
	Blue key + 0	 key	Blue key + X	Turns on and off the keypad backlight.
	Blue key + 1	Blue key + F1	Blue key + D	Increases display backlight intensity.
	Blue key + 4	Blue key + F5	Blue key + I	Increases display backlight intensity.
	Blue key + 3	Blue key + F4	Blue key + H	Increases scan decode beeper volume.
	Blue key + 6	Blue key + F8	Blue key + M	Decreases scan decode beeper volume.
ALT	Blue key + CTRL	Blue key + CTRL	Blue key + CTRL	Enables Alt keypad functions.
	Not available	Not available	Not available	Sends TAB character (forward tab).

✓ **NOTE** Use of display and keypad backlighting can significantly reduce battery life.

Special Characters

The keypads can be selected as necessary to support specialized applications. The keypads contain a **Power** button, application keys, scroll keys and function keys. The keypad is color-coded to indicate the alternate function key (blue) values and the alternate ALPHA key (orange) values. See [Table B-8](#) for the special character generation. Characters can also be generated using the keyboard input panel.

Table B-8 *Special Character Generation Map*

Special Character	28-Key Keypad	43-Key Keypad	53-Key Keypad
[(open square bracket)			Blue Key - E
] (close square bracket)			Blue Key - F
/ (forward slash)	Blue Key - 9	Blue Key - F12	Blue Key - L , Blue Key - V
\ (Backslash)			Blue Key - G
= (equal sign)	Blue Key - 5	Blue Key - BKSP	Blue Key - W
; (semi-colon)			Blue Key - R
' (apostrophe)			Blue Key - J
, (comma)			Blue Key - A
. (period)			Blue Key - B
! (exclamation point)			SHIFT - 1
@ (at sign)			SHIFT - 2
# (Pound sign)			SHIFT - 3
\$ (dollar sign)			SHIFT - 4
% (percent sign)			SHIFT - 5
^ (carat)			SHIFT - 6

Table B-8 *Special Character Generation Map (Continued)*

Special Character	28-Key Keypad	43-Key Keypad	53-Key Keypad
& (ampersand)			SHIFT - 7
* (asterisk)	Blue Key - .(period), SHIFT - Blue Key - .(period)		Blue Key - U , SHIFT - Blue Key - U , SHIFT - 8
((open parenthesis)			SHIFT - 9
) (close parenthesis)			SHIFT - 0
' (single quote)			Blue Key - C
" (double quote)			SHIFT - Blue Key - C
+ (plus sign)	SHIFT - Blue Key - 5 , Blue Key - 7 , SHIFT - Blue Key - 7	Blue Key - F9 , SHIFT - Blue Key - F9 , SHIFT - Blue Key - BKSP	Blue Key - S , SHIFT - Blue Key - S , SHIFT - Blue Key - W
- (dash)	Blue Key - 8	Blue Key - F10 , SHIFT - Blue Key - F10	Blue Key - N , Blue Key - T , SHIFT - Blue Key - T
: (colon)			SHIFT - Blue Key - R
< (less than sign)			SHIFT - Blue Key - A
> (greater than sign)			SHIFT - Blue Key - B
? (question mark)	SHIFT - Blue Key - 9	SHIFT - Blue Key - F12	SHIFT - Blue Key - L , SHIFT - Blue Key - V
_ (underscore)	SHIFT - Blue Key - 8		SHIFT - Blue Key - N
{ (open curly bracket)			SHIFT - Blue Key - E
} (close curly bracket)			SHIFT - Blue Key - F

Table B-8 *Special Character Generation Map (Continued)*

Special Character	28-Key Keypad	43-Key Keypad	53-Key Keypad
~ (tilde)			SHIFT - Blue Key - J
 (pipe)			SHIFT - Blue Key - G
Tab	Blue Key - Space	Blue Key - Space	Blue Key - Space

INDEX

Numerics

12 volt auto charge cable	7-2
24 volt auto charge cable	7-2
28-key keypad	7-3, B-2
2-D bar codes	4-3
3270 emulator keypad	B-14
43-key keypad	7-3, B-6
5250 emulator keypad	B-18
53-key 3270 keypad	7-3
53-key 5250 keypad	7-3
53-key keypad	7-3, B-10
53-key VT keypad	7-3
53-key White keypad	7-3

A

accessories

12 volt auto charge cable	7-2
24 volt auto charge cable	7-2
28-key keypad	7-3
43-key keypad	7-3
53-key 3270 keypad	7-3
53-key 5250 keypad	7-3
53-key keypad	7-3
53-key VT keypad	7-3
53-key White keypad	7-3
belt	7-3
belt clip	7-4
cables	7-3
CAM	7-3, 7-11
installation	7-11
DC line cord	7-2
DEX cable	7-2
fork lift cradle	7-1
fork lift high voltage power converter	7-2
fork lift low voltage power converter	7-2

fork lift power input cable	7-2
four slot charge only cradle	7-9
four slot Ethernet cradle	7-8
four slot Ethernet/USB cradle	7-1
four slot spare battery charger	7-1
handstrap	7-3
heated boot	7-3
holster, quick release	7-3
MC90XX Cradle Bracket	7-4
MC90XX wall mounting bracket	7-3
modem cable	7-2
MSR	
battery charging	7-14
power connection	7-12
serial connection	7-13
O'Neil printer cable	7-2
paxar printer cable	7-2
power supply	7-2
protective boot	7-3
RCH50 adapter cable	7-4
rugged cable headset	7-4
screen protector	7-4
serial cable	7-3
serial/USB cradle	7-1
shoulder strap	7-3
single slot serial/USB cradle	7-6
LED indicators	7-7, 7-10
spare battery	7-2
spare battery charger	7-10
stylus kit	7-4
UBC	
battery insertion	7-14
UBC four slot base	7-1
universal battery charger adapter	7-1
USB cable	7-2
USB sync cable	7-2
zebra printer cable	7-2

Index - 2 Product Name and Guide Type

ActiveSync	2-11
icon	2-8
adaptive frequency hopping	5-1
AFH	5-1
albums	3-19
aligning screen	1-6
application shortcuts	3-6
applock administrator	3-11
attaching MC92N0-G strap	1-7

B

backlight	B-26
backlight intensity	B-26
backup battery	
charging	1-3
bar codes	
two dimensional	4-3
battery	
backup charging	1-3
charging	1-3
removing	1-5
battery charging temperature	A-2
battery icon	2-1, 2-9
battery management	1-7
battery status	2-2
beeper volume	B-26
belt	7-3
belt clip	7-4
Bluetooth	5-1
adaptive frequency hopping	5-1
bonding	5-29
deleting bonded device	5-30
security	5-2
turning off	5-7, 5-14
turning on	5-7, 5-14
bluetooth	
communicating icon	2-2
disabled icon	2-2
discovering devices	5-7, 5-12, 5-15
enabled icon	2-2
turning on and off	5-7, 5-14
bonding	
Bluetooth	5-29
boot	
cold	1-6, 2-17, 2-24, 2-25
warm	2-17, 2-24, 2-25
browser	3-9
bullets	xvii
buttons	
power	2-17

C

cable	
12 volt auto charge cable	7-2
24 volt auto charge cable	7-2
DC line cord	7-2
DEX cable	7-2
fork lift power input cable	7-2
modem cable	7-2
O'Neil printer cable	7-2
paxar printer cable	7-2
RCH50 adapter cable	7-4
serial cable	7-3
USB cable	7-2
USB sync cable	7-2
zebra printer cable	7-2
Cable Adapter Module	7-3
cables	7-3
calculator	2-11, 3-9
calendar	2-11, 3-9
calibrating screen	1-6
CAM	7-3, 7-11
installation	7-11
changing the power settings	1-7
characters, special	B-27
charging	
spare batteries	1-4
charging batteries	1-3
charging spare batteries	1-4
cleaning	8-1
clock	3-9
clock & alarms	2-12
cold boot	1-6, 2-17, 2-24, 2-25
command bar	
icons	2-7, 2-10
configuration	1-2
configurations	xiv
Contacts	2-10
contacts	3-10
conventions	
notational	xvi
CPU	A-1
cradles	
fork lift	7-1
four slot charge only	7-9
four slot Ethernet	7-8
four slot Ethernet/USB	7-1
serial/USB	7-1
single slot	7-6
LED indicators	7-7, 7-10
spare battery charger	7-10
current time	2-1

D

data capture	
imager operational modes	
decode mode	4-3
image capture mode	4-3
pick list mode	4-3
imaging	4-3
scanning	4-3
two dimensional bar codes	4-3
datawedge	3-10
date/time	2-1
DC line cord	7-2
DCP for MC92N0c70	xvii
deleting Bluetooth bond	5-30
Device Configuration Package for MC92N0c70	xvii
DEX cable	7-2
diagnostics	3-29
dimensions	A-1
display	A-1
display backlight	
saving power	1-8
display backlight intensity	B-26
downloads	3-10
drop specification	A-2
DWDEmo	3-10

E

EAP	3-31
electro-static discharge	
Elemex	3-29
email	3-10
ESD	7-5

F

file browser	3-10, 3-16
file explorer	2-11
fork lift cradle	7-1
fork lift high voltage power converter	7-2
fork lift low voltage power converter	7-2
fork lift power input cable	7-2
four slot charge only cradle	7-9
four slot Ethernet cradle	7-8
four slot Ethernet/USB	7-1
four slot spare battery charger	7-1

G

gallery	3-10
getting started	1-2

H

handstrap	7-3
hard reset	1-6, 2-17, 2-24, 2-25
headset	1-12, 1-13, 2-23, 2-24
heated boot	7-3
hexadecimal keys	2-21
holster	7-3
humidity	A-2

I

icons	
ActiveSync	2-8
alpha mode	2-2
ALT	2-2, 2-8
battery	2-9
bluetooth communicating	2-2
bluetooth disabled	2-2
bluetooth enabled	2-2
CTRL	2-2, 2-8
function	2-2, 2-8
shift	2-2, 2-8
status	2-8
task tray	2-7, 2-10
wireless status	2-7
imager. See data capture, imaging	
imaging	4-3
information, service	xvii
Internet Explorer Mobile	2-3, 2-10
internet sharing	2-11
IrDA	2-13

K

key descriptions	
28-key	B-3
3270	B-15
43-key	B-7
5250	B-19
53-key	B-11
special functions	B-26
VT	B-23
keyboard	3-8, A-1
keypad	
28-key keypad	7-3
43-key keypad	7-3
53-key 3270 keypad	7-3
53-key 5250 keypad	7-3
53-key keypad	7-3
53-key VT keypad	7-3
53-key White keypad	7-3
keypad backlight	
saving power	1-8

Index - 4 Product Name and Guide Type

keypad functions	.xvi
keypads	
28-key	B-2
3270 emulator	B-14
43-key	B-6
5250 emulator	B-18
53-key	B-10
special functions	B-26
types	1-11, B-1
VT emulator	B-22

L

laser scanning	4-1
LED Indicator Bar	1-11
lithium-ion battery	1-2

M

main battery	
charging	1-2, 1-3
installing	1-2
maintenance	8-1
masked characters	2-21
MC90XX Cradle Bracket	7-4
MC90XX wall mounting bracket	7-3
Media Player	2-11
memory	A-2
messaging	2-11
mobile computer	
power on	2-17
scanning	4-1
starting	1-6
mobile computer configuration	1-2
modem cable	7-2
MSP Agent	2-3, 2-12
MSR	
battery charging	7-14
power connection	7-12
serial connection	7-13
multiuser administrator	3-11

N

naming folders	3-7
navigation bar	
icons	2-8
notes	2-11

O

O'Neil printer cable	7-2
operating environment, mobile computer	A-1
operating system	A-1

operating temperature	A-2
-----------------------	-----

P

parts of the mobile computer	1-1, 7-16
front view	1-2
pass-phrase	2-21
passwords	2-16
paxar printer cable	7-2
PEAP-GTC	3-31
PEAP-MSCHAPv2	3-31
pictures	2-11
power button	2-17
power settings	1-7
power supply	7-2
protective boot	7-3

Q

quick release holster	7-3
-----------------------	-----

R

rapid deployment	2-3, 2-12
RCH50 adapter cable	7-4
related documents	xvii
related software	xvii
removing main battery	1-5
reset	
hard	1-6, 2-17, 2-24, 2-25
soft	2-17, 2-24, 2-25
resetting	2-24, 3-15
resume	5-4
rugged cable headset	7-4

S

scan LED indicators	4-1
scan status	4-1
scanning	
angle	4-2
imaging	4-3
indicator	4-1
LED indicators	4-1
range	4-2
scanning considerations	4-2
screen	
calibration	1-6
screen protector	7-4
secure storage administrator	3-11
security	
Bluetooth	5-2
serial cable	7-3
serial/USB cradle	7-1

- settings 3-11
 - about 2-13
 - beam 2-13
 - buttons 2-13
 - certificates 2-13
 - connections 2-13
 - customer feedback 2-13
 - encryption 2-13
 - error reporting 2-13
 - keylight 2-13
 - lock 2-12
 - memory 2-13
 - owner information 2-13
 - power 2-13
 - regional settings 2-14
 - remove programs 2-14
 - screen 2-14
 - sounds & notifications 2-12
 - system info 2-14
 - USB to PC 2-13
 - Wi-Fi 2-13
 - wireless manager 2-13
 - shoulder strap 7-3
 - single slot serial/USB cradle 7-6
 - LED indicators 7-7, 7-10
 - soft reset 2-17, 2-24, 2-25, 3-15
 - spare batteries
 - charging 1-4
 - spare battery 7-2
 - charging 1-4
 - spare battery charger 7-10
 - special characters B-27
 - specifications A-1
 - starting the mobile computer 1-2, 1-6
 - status 2-1
 - status icon 2-1, 2-2, 2-8
 - battery 2-9
 - status icons
 - Windows CE 7.0 2-1
 - storage temperature A-2
 - strap 1-2, 1-7
 - attaching to the MC92N0-G 1-7
 - stylus 1-2
 - stylus kit 7-4
 - suspend 2-17, 5-4
 - synchronize with PC
 - using Bluetooth 5-10
- T**
- task tray icons 2-7
 - taskbar 2-1
 - tasks 2-11
 - technical specifications, mobile computer A-1
- terminal
 - charging 2-1
 - terminal charging 2-1
 - terminal emulation 3-30, 3-31
 - TLS 3-31
 - troubleshooting 8-5
 - cable adapter module 8-9
 - four slot spare battery charger 8-8
 - magnetic stripe reader 8-10
 - mobile computer 8-5
 - single slot serial/USB cradle 8-8
 - TTLS
 - TTLS-MSCHAP 3-31
 - TTLS-MSCHAPv2 3-31
 - TTLS-PAP 3-31
 - turning the radios off
 - WLAN 1-9
- U**
- UBC 7-14
 - UBC four slot base 7-1
 - universal battery charger 7-14
 - universal battery charger adapter 7-1
 - unpacking 1-2
 - USB cable 7-2
 - USB sync cable 7-2
 - using headset 1-12, 1-13, 2-23, 2-24
- V**
- videos 2-11
 - volume B-26
 - VT emulator keypad B-22
- W**
- wakeup conditions 2-26
 - warm boot 2-17, 2-24, 2-25
 - weight A-1
 - WEP 3-31
 - Windows Live 2-11
 - Windows Live Messenger 2-11
 - Wireless 1-9
 - Wireless Manager 1-9
 - wireless manager 2-13
 - wireless status 2-7
 - wireless status icon 2-2
 - WLAN status 2-2
 - WPA 3-31
- Z**
- zebra printer cable 7-2



Zebra Technology Corporation
3 Overlook Point
Lincolnshire, IL 60069 USA
<http://www.zebra.com>

Zebra and the stylized Zebra head are trademarks of ZIH Corp., registered in many jurisdictions worldwide. All other trademarks are the property of their respective owners.

©2016 Symbol Technologies LLC, a subsidiary of Zebra Technologies Corporation. All rights reserved.

72E-162536-06 Revision A - December 2016