

MC3200 USER GUIDE

Copyrights

The products described in this document may include copyrighted computer programs. Laws in the United States and other countries preserve for certain exclusive rights for copyrighted computer programs. Accordingly, any copyrighted computer programs contained in the products described in this document may not be copied or reproduced in any manner without the express written permission.

© 2017 ZIH Corp and/or its affiliates. All rights reserved.

No part of this document may be reproduced, transmitted, stored in a retrieval system, or translated into any language or computer language, in any form or by any means, without the prior written permission.

Furthermore, the purchase of our products shall not be deemed to grant either directly or by implication, estoppel or otherwise, any license under the copyrights, patents or patent applications, except for the normal non-exclusive, royalty-free license to use that arises by operation of law in the sale of a product.

Disclaimer

Please note that certain features, facilities, and capabilities described in this document may not be applicable to or licensed for use on a particular system, or may be dependent upon the characteristics of a particular mobile subscriber unit or configuration of certain parameters. Please refer to your contact for further information.

Trademarks

ZEBRA and the stylized Zebra head are trademarks of ZIH Corp, registered in many jurisdictions worldwide. All other trademarks are the property of their respective owners.

Revision History

Changes to the original guide are listed below:

Change	Date	Description
A01 Rev. A	06/2014	Initial release.
A02 Rev. A	04/2015	Rev B software update.
A02 Rev. B	02/2016	Update 48-key Keypad Input Modes
A03 Rev. A	07/2017	Correct MC32N0-R/S battery replacement steps.

Contents

Copyrights.....	3
Revision History.....	5
About This Guide.....	13
MC32N0 Series Documentation Set.....	13
Configurations.....	13
Chapter Descriptions.....	15
Notational Conventions.....	16
Icon Conventions.....	16
Related Documents.....	16
Service Information.....	17
Chapter 1: Getting Started.....	19
MC32N0-G Features.....	19
MC32N0-R Features.....	22
MC32N0-S Features.....	24
Unpacking.....	26
Setup.....	27
Installing a microSD Card.....	27
Installing the MC32N0-G Battery.....	28
Installing the MC32N0-R/S Battery.....	30
Charging the Battery.....	31
Replacing the MC32N0-G Battery.....	32
Replacing the MC32N0-R/S Battery.....	35
Battery Management on Android™ Devices.....	37
Battery Management on WinCE Devices.....	39
Battery Optimization.....	40
Connecting a Wired Headset.....	40
Using a Bluetooth Headset.....	40
Real-Time Clock Backup.....	41
Chapter 2: Using the MC32N0 with Android™.....	43
Home Screen.....	43
Status Bar.....	44
Status Icons.....	44
Notification Icons.....	46
Managing Notifications.....	46
Application Shortcuts and Widgets.....	47
Adding an Application or Widget to the Home Screen.....	47
Moving Items on the Home Screen.....	47
Removing an App or Widget from the Home Screen.....	47
Folders.....	48
Creating Folders.....	48
Naming Folders.....	48
Removing a Folder.....	49
Home Screen Wallpaper.....	49
Change the Home Screen Wallpaper.....	49
Using the Touchscreen.....	49
Using the On-screen Keyboard.....	50
Applications.....	50

Accessing Applications.....	52
Switching Between Recent Applications.....	53
File Browser.....	53
People.....	54
Adding People.....	54
Editing People.....	55
Deleting People.....	55
Gallery.....	55
Working with Albums.....	56
Working with Photos.....	57
Working with Videos.....	60
DataWedge Demonstration.....	61
MLog Manager.....	62
Sound Recorder.....	63
PTT Express Voice Client.....	63
Enabling PTT Communication.....	64
PTT Communication.....	65
Disabling PTT Express Voice Client Communication.....	66
Un-Locking the Screen.....	66
Single User Mode.....	66
MultiUser Mode.....	67
MultiUser Login.....	67
MultiUser Logout.....	68
Resetting the Android Device.....	68
Performing a Soft Reset.....	68
Performing a Hard Reset.....	68
Suspend Mode.....	69
Setting the Date and Time.....	69
Display Setting.....	70
Setting the Screen Brightness.....	70
Changing the Screen Timeout Setting.....	70
General Sounds Setting.....	71
Calibration Screen.....	71
Wireless Local Area Networks.....	72
Scan and Connect to a Wi-Fi Network.....	73
Configuring a Wi-Fi Network.....	74
Manually Adding a Wi-Fi Network.....	75
Configuring for a Proxy Server.....	75
Configuring the Device to Use a Static IP Address.....	76
Advanced Wi-Fi Settings.....	77
Remove a Wi-Fi Network.....	78
Bluetooth.....	78
Adaptive Frequency Hopping.....	79
Security.....	79
Bluetooth Profiles.....	79
Bluetooth Power States.....	80
Bluetooth Radio Power – Android.....	80
Enabling Bluetooth.....	80
Disabling Bluetooth.....	80
Discovering Bluetooth Device(s).....	81
Changing the Bluetooth Name.....	82
Connecting to a Bluetooth Device.....	82
Selecting Profiles on the Bluetooth Device.....	82
Unpairing a Bluetooth Device.....	82

Chapter 3: Using the MC32N0 with Windows CE.....	85
Sample Applications Window.....	85
Desktop.....	85
Taskbar.....	86
Status Icons.....	86
Control Panel.....	87
Start Menu.....	89
DataWedge Demo.....	90
PTT Express Configuration.....	91
Creating a Group Call.....	92
Responding with a Private Response.....	92
Battery Health Management.....	92
Battery Health.....	93
Entering Information.....	94
Calibration Screen.....	95
Interactive Sensor Technology.....	96
Resetting the MC32N0.....	97
Performing a Warm Boot.....	97
Performing a Cold Boot.....	97
WLAN.....	98
Signal Strength Icon.....	99
Fusion Setup.....	99
Using Bluetooth with Windows CE.....	102
Adaptive Frequency Hopping.....	102
Security.....	102
Bluetooth Profiles.....	103
MotoBTUI Application.....	103
Viewing Device Information.....	104
FIPS Configuration.....	104
DeviceStatus.....	105
Using Microsoft Bluetooth Stack with Windows CE.....	105
Bluetooth Radio Power – Windows CE.....	106
Power Modes.....	107
Discovering Bluetooth Device(s).....	107
Using StoneStreet Bluetooth Stack with Windows CE.....	108
Turning the Bluetooth Radio Mode On and Off.....	108
Modes.....	108
Discovering Bluetooth Device(s).....	109
Pairing with Discovered Device(s).....	111
Bluetooth Settings.....	112
Chapter 4: Data Capture.....	117
Imager.....	117
Laser Scanner.....	117
RS507 Hands-Free Imager.....	118
Scanning Considerations.....	118
Bar Code Capture with Imager.....	119
Bar Code Capture with Laser Scanner.....	120
Bar Code Capture with RS507 Hands-Free Imager.....	121
Pairing the RS507 Hands-Free Imager Using SSI on Android.....	122
Pairing the RS507 Hands-Free Imager Bluetooth HID on Android.....	122
Pairing the RS507 Hands-Free Imager Using SSI on WinCE.....	123
Pairing the RS507 Hands-Free Imager Bluetooth HID on WinCE.....	124

DataWedge on Android.....	124
Enabling DataWedge.....	124
Disabling DataWedge.....	125
DataWedge on WinCE.....	125
Enabling DataWedge.....	125
Disabling DataWedge.....	126
Chapter 5: Accessories.....	127
MC32N0 Accessories.....	127
Battery Adapter.....	130
Installing the Battery Adapter.....	130
Removing the Battery Adapter.....	131
Single Slot Serial/USB Cradle.....	132
Charging the MC32N0 Battery.....	132
Charging an MC32N0 Spare Battery.....	133
Battery Charging in Single Slot Serial/USB Cradle.....	134
Four Slot Charge Only Cradle.....	135
Charging the MC32N0 Battery.....	135
Battery Charging in the Four Slot Charge Only Cradle.....	136
Four Slot Ethernet Cradle.....	136
Establishing Ethernet Connection.....	137
Ethernet Cradle Drivers.....	137
LED Indicators.....	137
Charging the MC32N0 Battery.....	138
Battery Charging in the Four Slot Ethernet Cradle.....	138
Four Slot Spare Battery Charger.....	138
Charging Spare Batteries.....	138
Battery Charging.....	139
Magnetic Stripe Reader.....	140
Installing the MSR.....	140
Using the MSR.....	140
Removing the MSR.....	141
MC32N0 Cables.....	141
Universal Battery Charger Adapter.....	142
Charging a Spare Battery in the UBC Adapter.....	142
UBC Adapter Battery Charging.....	143
Plastic Holster.....	143
Fabric Holster.....	145
Using the Belt Clip.....	147
Using the Shoulder Strap.....	149
Chapter 6: Maintenance and Troubleshooting.....	151
Maintaining the MC32N0.....	151
Battery Safety Guidelines.....	151
Cleaning Instructions.....	152
Cleaning the MC32N0.....	153
Housing.....	153
Display.....	153
Camera Window.....	153
Connector Cleaning.....	153
Cleaning Cradle Connectors.....	154
Troubleshooting the MC32N0.....	154

Chapter 7: Technical Specifications.....	157
MC32N0 Technical Specifications.....	157
Chapter 8: MC32N0 Keypads.....	161
MC32N0 28-Key Keypad.....	161
MC32N0 38-Key Keypad.....	165
MC32N0 48-Key Keypad.....	169

About This Guide

This guide provides information about using the MC32N0 Series of mobile computers and accessories.



Note: Screens and windows pictured in this guide are samples and can differ from actual screens.

MC32N0 Series Documentation Set

The documentation set for the MC32N0 Series provides information for specific user needs, and includes:

- *MC32N0 Quick Start Guide* - describes how to get the device up and running.
- *MC32N0 Regulatory Guide* - provides required regulatory information.
- *MC32N0 User Guide* - describes how to use the device.
- *MC32N0 Integrator Guide* - describes how to set up the device and accessories.

Configurations

This guide covers the following configurations:

Configuration	Radios	Display	Memory	Data Capture Options	Operating System
MC32N0–G Standard	WLAN: 802.11a/b/g/n WPAN: Blue- tooth v2.1 with EDR	3.0” color	512 MB RAM / 2 GB Flash	Imager or laser scanner	Windows CE 7.0
MC32N0–G Premium	WLAN: 802.11a/b/g/n WPAN: Blue- tooth v2.1 with EDR	3.0” color	1 GB RAM / 4 GB Flash	Imager or laser scanner, Interac- tive Sensor Technology (IST)	Android-based, Android Open- Source Project 4.1.1 or Win- dows CE 7.0
MC32N0–R Standard	WLAN: 802.11a/b/g/n WPAN: Blue- tooth v2.1 with EDR	3.0” color	512 MB RAM / 2 GB Flash	Laser scanner	Windows CE 7.0
MC32N0–R Premium	WLAN: 802.11a/b/g/n WPAN: Blue- tooth v2.1 with EDR	3.0” color	1 GB RAM / 4 GB Flash	Laser scanner, IST	Android-based, Android Open- Source Project 4.1.1 or Win- dows CE 7.0

Table continued...

Configuration	Radios	Display	Memory	Data Capture Options	Operating System
MC32N0–S Standard	WLAN: 802.11a/b/g/n WPAN: Blue- tooth v2.1 with EDR	3.0” color	512 MB RAM / 2 GB Flash	Imager or laser scanner	Windows CE 7.0
MC32N0–S Premium	WLAN: 802.11a/b/g/n WPAN: Blue- tooth v2.1 with EDR	3.0” color	1 GB RAM / 4 GB Flash	Imager or laser scanner, IST	Android-based, Android Open- Source Project 4.1.1 or Win- dows CE 7.0

Software Versions for Android

To determine the current software versions touch  >  **About device**.

- **Serial number** – Displays the serial number.
- **Model number** – Displays the model number.
- **Android version** – Displays the operating system version.
- **Kernel version** – Displays the kernel version number.
- **Build number** – Displays the software build number.

Software Versions for WinCE

This guide covers various software configurations and references are made to operating system or software versions for:

- OEM version
- BTE Explorer version
- Fusion version.

OEM Version

To determine the OEM software version tap **Start** > **Settings** > **Control Panel** > **System Info** icon > **System** tab.

Figure 1: System Info – OEM Version



BTE Explorer Software



Note: StoneStreet Bluetooth stack has to be enabled to see version number.

To determine the BTE Explorer software version tap **BTE Explorer** icon > **Show BTE Explorer** > **File** > **About**.

Figure 2: BTE Explorer Version



Fusion Software

To determine the Fusion software version tap **Wireless Strength** icon > **Wireless Status** > **Versions**.

Figure 3: Fusion Version



Chapter Descriptions

Topics covered in this guide are as follows:

- [Getting Started on page 19](#) provides information on getting the MC32N0 up and running for the first time.
- [Using the MC32N0 with Android™ on page 43](#) provides basic instructions for using the MC32N0 with Android OS, including powering on and resetting the MC32N0.
- [Using the MC32N0 with Windows CE on page 85](#) provides basic instructions for using the MC32N0 with WinCE7 OS, including powering on and resetting the MC32N0.
- [Data Capture on page 117](#) provides information for capturing bar code data using the internal camera and optional scan modules and Bluetooth scanner.
- [Accessories on page 127](#) describes the available accessories and how to use them with the MC32N0.
- [Maintenance and Troubleshooting on page 151](#) includes instructions on cleaning and storing the MC32N0, and provides troubleshooting solutions for potential problems during MC32N0 operation.

- *Technical Specifications on page 157* provides the technical specifications for the MC32N0.
- *MC32N0 Keypads on page 161* - provides keypad descriptions and special character generation tables.

Notational Conventions

The following conventions are used in this document:

- *Italics* are used to highlight the following:
 - Chapters and sections in this and related documents
 - Icons on a screen.
- **Bold** text is used to highlight the following:
 - Dialog box, window, and screen names
 - Drop-down list and list box names
 - Check box and radio button names
 - Button names on a screen.
- Bullets (•) indicate:
 - Action items
 - Lists of alternatives
 - Lists of required steps that are not necessarily sequential
- Sequential lists (for example, lists that describe step-by-step procedures) appear as numbered lists.

Icon Conventions

The documentation set is designed to give the reader more visual clues. The following graphic icons are used throughout the documentation set. These icons and their associated meanings are described below.



Warning: The word WARNING with the associated safety icon implies information that, if disregarded, could result in death or serious injury, or serious product damage.



Caution: The word CAUTION with the associated safety icon implies information that, if disregarded, may result in minor or moderate injury, or serious product damage.



Note: NOTE contains information more important than the surrounding text, such as exceptions or preconditions. They also refer the reader elsewhere for additional information, remind the reader how to complete an action (when it is not part of the current procedure, for instance), or tell the reader where something is located on the screen. There is no warning level associated with a note.

Related Documents

- *MC32N0 Quick Start Guide*, p/n MN000215A01
- *MC32N0 Regulatory Guide*, p/n MN000216A01
- *MC32N0 Integrator Guide*, p/n MN000887A01

For the latest version of this guide and all guides, go to: <http://www.zebra.com/support>

Service Information

If you have a problem with your equipment, contact Zebra Support Center for your region. Contact information is available at: <http://www.zebra.com/support>.

When contacting the Zebra Support Center, please have the following information available:

- Serial number of the unit (found on manufacturing label)
- Model number or product name (found on manufacturing label)
- Software type and version number

Figure 4: Manufacturing Label Location

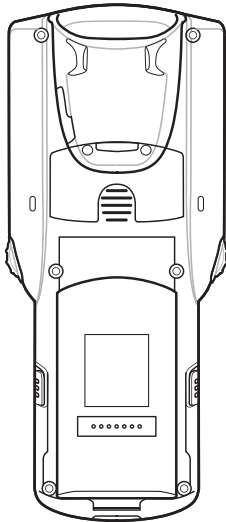

Zebra responds to calls by email or telephone within the time limits set forth in support agreements.

If your problem cannot be solved by the Zebra Support Center, you may need to return your equipment for servicing and will be given specific directions. Zebra is not responsible for any damages incurred during shipment if the approved shipping container is not used. Shipping the units improperly can possibly void the warranty.

If you purchased your product from a Zebra business partner, contact that business partner for support.

Chapter 1

Getting Started

This chapter provides the features of the MC32N0 and explains how to set it up for the first time.

MC32N0–G Features

Figure 5: Front View

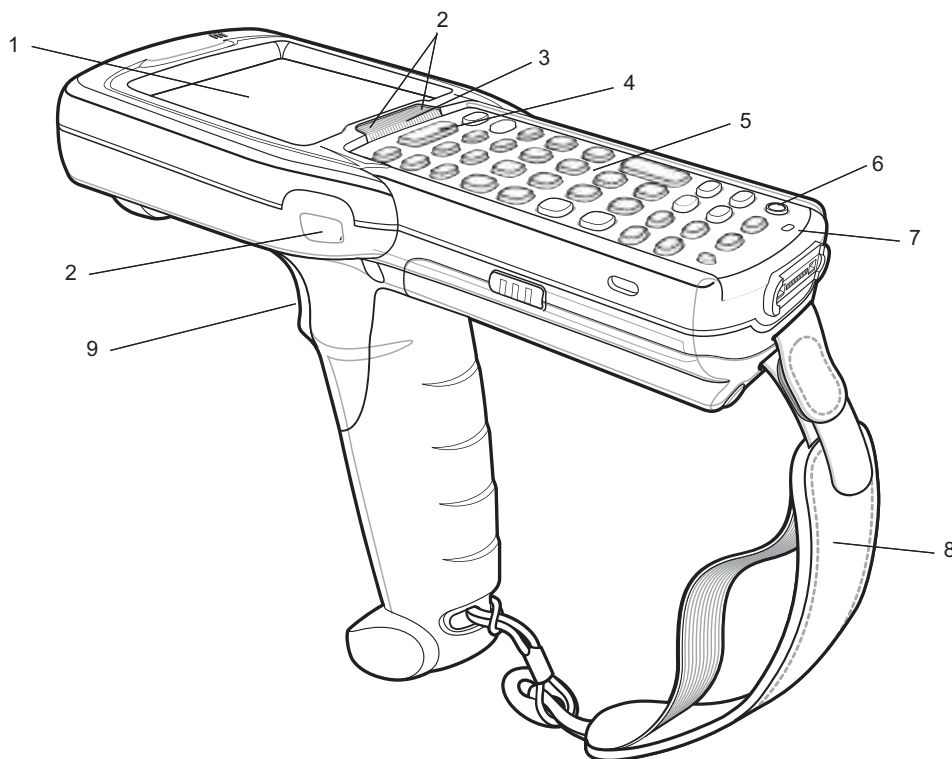
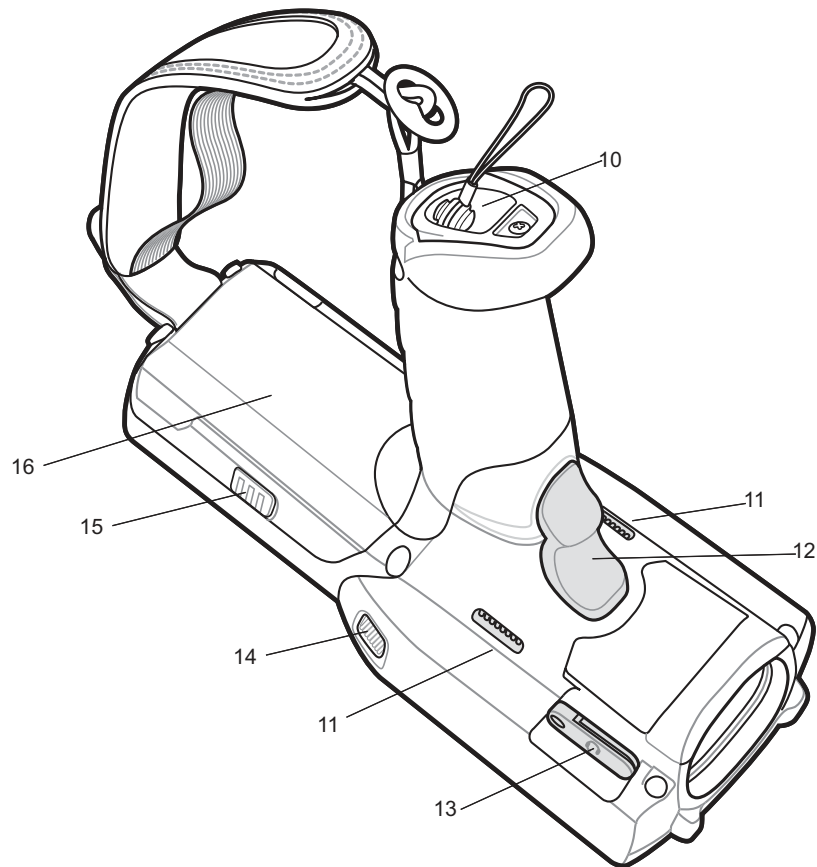

Table 1: Features - Front View

Number	Item	Function
1	Display	Displays all information needed to operate the MC32N0–G.
2	Scan LED	Indicates decode functionality. Light green indicating a successful decode.
3	Charge LED	Indicates the battery charge state while charging.
4	Scan Button	Initiates data capture when a scan application is enabled.

Table continued...

Number	Item	Function
5	Keypad	Use to enter data and navigate on screen functions.
6	Power Button	<p>On Android devices: Press and hold to turn on the MC32N0-G. Press to turn on or off the screen. Press and hold to select one of these options:</p> <ul style="list-style-type: none"> • Power off - Turn off the MC32N0-G. • Reset - Reboot the MC32N0-G when software stops responding. • Airplane mode - Disable all wireless connections. • Battery swap - Places the device in Battery Swap mode when replacing the battery. • Silent mode - All notifications are disabled except for alarms. <p>On WinCE devices: Press to display power option:</p> <ul style="list-style-type: none"> • Suspend (Sleep mode) – Places the device in sleep mode when not using the device for a period of time. • Battery Swap – Places the device in Battery Swap mode when replacing the battery. • Cancel – Close window and cancel operation.
8	Handstrap	Use for securely holding the device.
9	Trigger	Initiates data capture when a scan application is enabled.

Figure 6: Bottom View**Table 2: Features - Back View**

Number	Item	Function
10	Stylus Silo	Holds the stylus securely in the handle.
11	Speakers	Provides audio output for video and music playback.
12	Trigger	Initiates data capture.
13	Headset Jack	Connects to headsets (2.5 mm plug).
14	Scan LED	Indicates data capture functionality.
15	Battery Release Buttons	Release the battery from the device.
16	Battery	Provides power for operating the device.

MC32N0-R Features

Figure 7: Front View

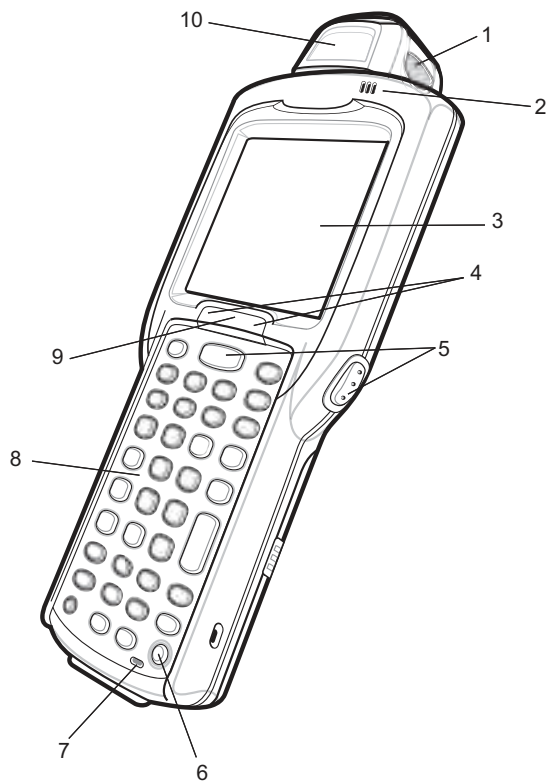

Table 3: Features - Front View

Number	Item	Function
1	Scan LED	Indicates decode functionality. Light green indicating a successful decode.
2	Beeper	Provides audio notifications.
3	Display	Displays all information needed to operate the MC32N0-R.
4	Scan Button	Initiates data capture.
5	Power Button	<p>On Android devices: Press and hold to turn on the MC32N0-R. Press to turn on or off the screen. Press and hold to select one of these options:</p> <ul style="list-style-type: none"> • Power off - Turn off the MC32N0-R. • Reset - Reboot the MC32N0-R when software stops responding. • Airplane mode - Disable all wireless connections. • Battery swap - Places the device in Battery Swap mode when replacing the battery. • Silent mode - All notifications are disabled except for alarms. <p>On WinCE devices: Press to display power option:</p>

Table continued...

Number	Item	Function
		<ul style="list-style-type: none"> • Suspend (Sleep mode) – Places the device in sleep mode when not using the device for a period of time. • Battery Swap – Places the device in Battery Swap mode when replacing the battery. • Cancel – Close window and cancel operation.
6	Microphone	Use for making voice recordings.
7	Keypad	Use to enter data and navigate on screen functions.
8	Charging LED	Indicates the battery charge state while charging.
9	Rotating Turret	Rotate for easy scanning positions.

Figure 8: Back View

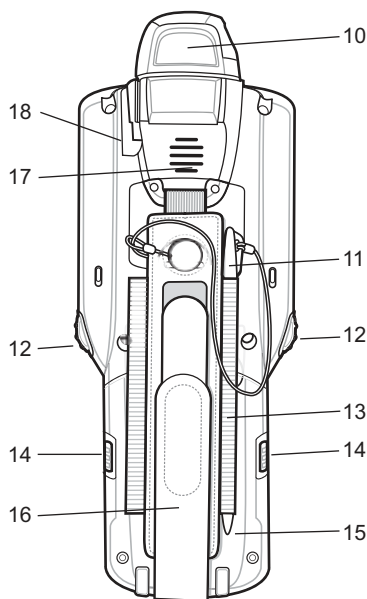

Table 4: Features - Back View

Number	Item	Function
10	Exit Window	Provides data capture using the laser scanner.
11	Stylus	Use to select items on the screen.
12	Scan Button	Initiates data capture.
13	Stylus Holder	Holds the stylus securely in the handstrap.
14	Battery Release Buttons	Release the battery from the device.
15	Battery	Provides the MC32N0-R with operating power.
16	Handstrap	Use for securely holding the device.
17	Speaker	Provides audio output for video and music playback.
18	Headset Jack	Connects to headsets (2.5 mm jack).

Rotating Scan Turret

The MC32N0-R features a Rotating Turret with three position stops. This feature offers greater scanning flexibility.



Caution: Do not try to rotate the turret past the side position stops. Damage to device may occur.

Figure 9: Rotating Turret

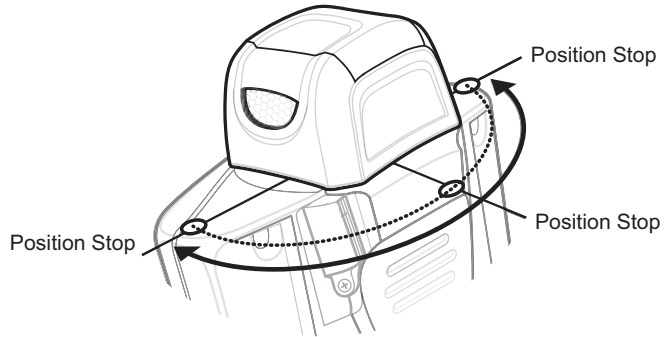

MC32N0-S Features

Figure 10: Front View

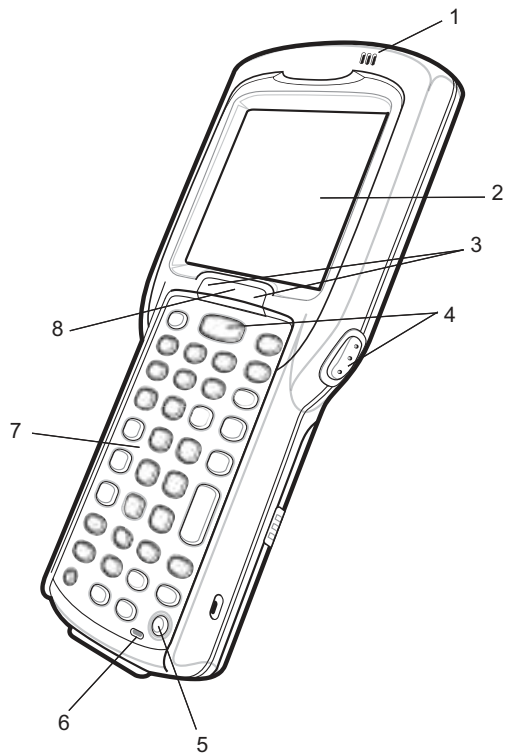
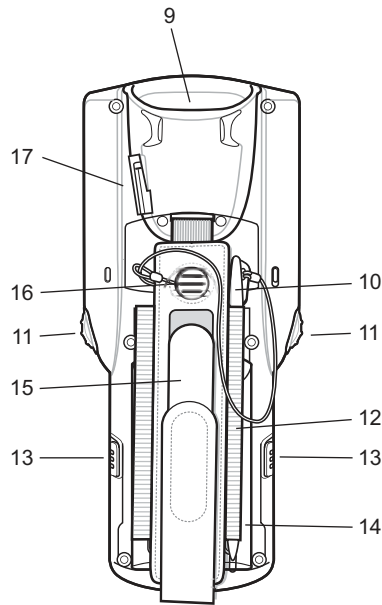

Table 5: Features - Front View

Number	Item	Function
1	Beeper	Provides audio notifications.
2	Display	Displays all information needed to operate the MC32N0-R.
3	Scan LED	Indicates decode functionality. Light green indicating a successful decode.
4	Scan Button	Initiates data capture.
5	Power Button	<p>On Android devices: Press and hold to turn on the MC32N0-S. Press to turn on or off the screen. Press and hold to select one of these options:</p> <ul style="list-style-type: none"> • Power off - Turn off the MC32N0-S. • Reset - Reboot the MC32N0-S when software stops responding. • Airplane mode - Disable all wireless connections. • Battery swap - Places the device in Battery Swap mode when replacing the battery. • Silent mode - All notifications are disabled except for alarms. <p>On WinCE devices: Press to display power option:</p> <ul style="list-style-type: none"> • Suspend (Sleep mode) – Places the device in sleep mode when not using the device for a period of time. • Battery Swap – Places the device in Battery Swap mode when replacing the battery. • Cancel – Close window and cancel operation.
6	Microphone	Use for making voice recordings.
7	Keypad	Use to enter data and navigate on screen functions.
8	Charging LED	Indicates the battery charge state while charging.

Figure 11: Back View**Table 6: Features - Back View**

Number	Item	Function
9	Exit Window	Provides data capture using the imager.
10	Stylus	Use to select items on the screen.
11	Scan Button	Initiates data capture.
12	Stylus Holder	Holds the stylus securely in the handstrap.
13	Battery Release Buttons	Release the battery from the device.
14	Battery	Provides the MC32N0-S with operating power.
15	Handstrap	Use for securely holding the device.
16	Speaker	Provides audio output for video and music playback.
17	Headset Jack	Connects to headset (2.5 mm jack).

Unpacking

Carefully remove all protective material from the MC32N0 and save the shipping container for later storage and shipping.

Verify the following items are in the box:

- MC32N0
- Lithium-ion battery
- Quick Start Guide
- Regulatory Guide.

Inspect the equipment for damage. If any equipment is missing or damaged, contact the Zebra Support Center immediately. See [Service Information on page 17](#) for contact information.

Setup

To start using the MC32N0 for the first time:

- Install a microSD card (optional)
- Install the battery
- Charge the MC32N0
- Power on the MC32N0.

Installing a microSD Card

The microSD card slot provides secondary non-volatile storage. The slot is located under the battery pack. Refer to the documentation provided with the card for more information, and follow the manufacturer's recommendations for use.



Caution: Follow proper electrostatic discharge (ESD) precautions to avoid damaging the microSD card. Proper ESD precautions include, but are not limited to, working on an ESD mat and ensuring that the operator is properly grounded.



Note: On Android devices, after installing the microSD card, the device will automatically reset. This ensures proper reading of the file content on the microSD card.

Procedure:

- 1 Remove the microSD card cover.

Figure 12: Remove microSD Card Cover

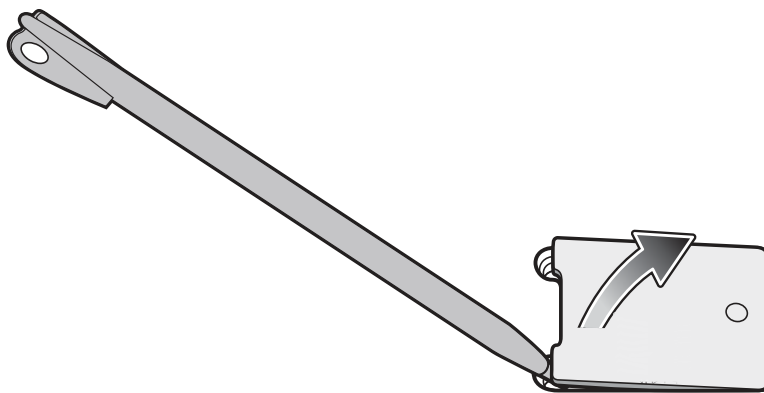

- 2 Slide the microSD card holder down to unlock.

Figure 13: Unlock microSD Card Holder

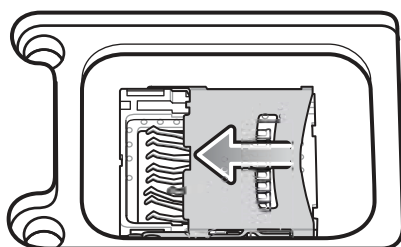

- 3 Lift the microSD card holder.

Figure 14: Lift microSD Card Holder

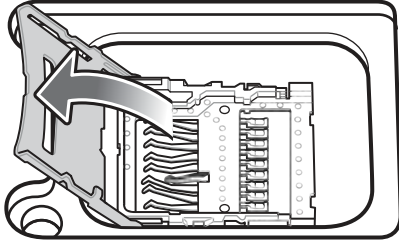

- 4 Place the microSD card into the contact area.

Figure 15: Install microSD Card

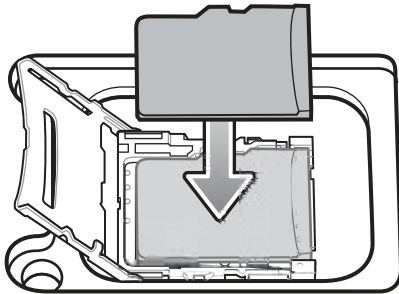

- 5 Close the microSD card holder and slide the microSD card holder up to lock.

Figure 16: Lock microSD Card Holder

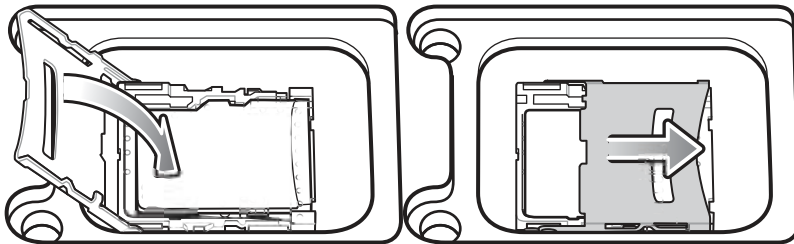

- 6 Replace the microSD card cover and ensure that it is installed properly.

Installing the MC32N0-G Battery

To install the battery:

Procedure:

- 1 Align the battery into the battery compartment.

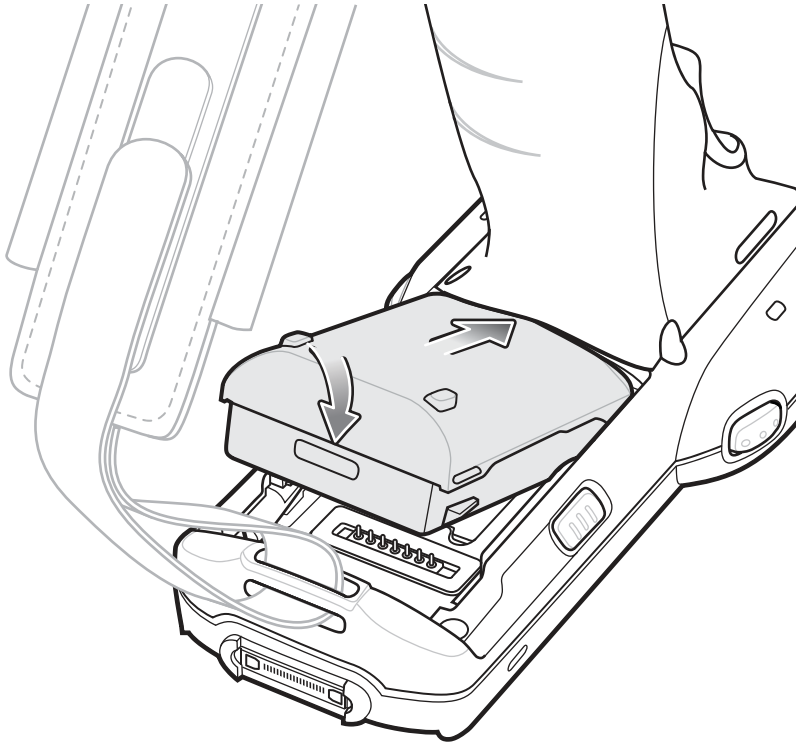
Figure 17: Inserting the Battery

- 2 Rotate the bottom of the bottom into the battery compartment.
- 3 Press battery down firmly. Ensure that both battery release buttons on the sides of the MC32N0 return to the home position.

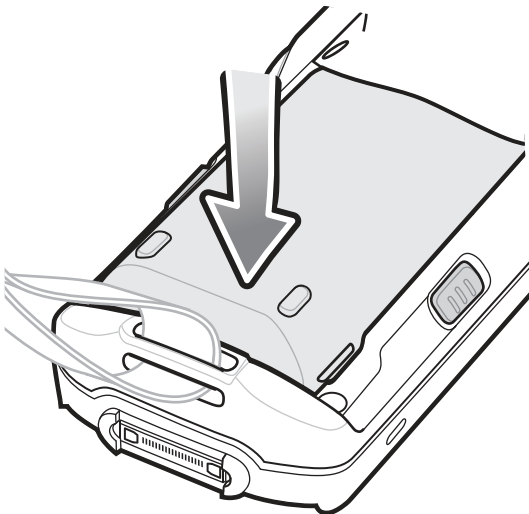
Figure 18: Press Battery Down

- 4 Press the Power button to turn on the device.
- 5 On WinCE device with Rev B software, after boot up the calibration screen appears. Using the stylus, touch the targets as they appear on the screen.

Installing the MC32N0–R/S Battery

Procedure:

- 1 Loosen the handstrap.
- 2 Align the top of the battery into the battery compartment.

Figure 19: Inserting the Battery

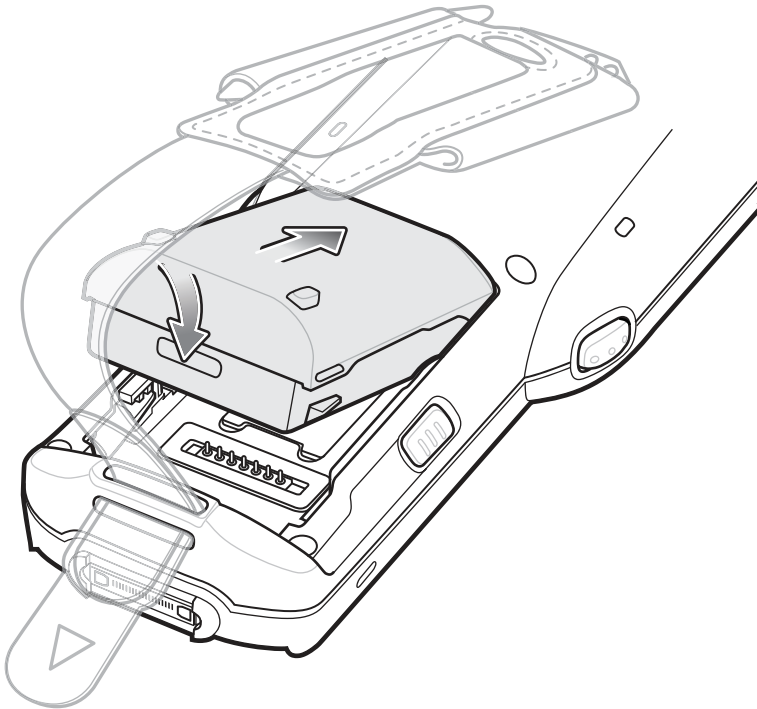

- 3 Rotate the bottom of the bottom into the battery compartment.
- 4 Press battery down firmly. Ensure that both battery release buttons on the sides of the MC32N0 return to the home position.

Figure 20: Press Battery Down

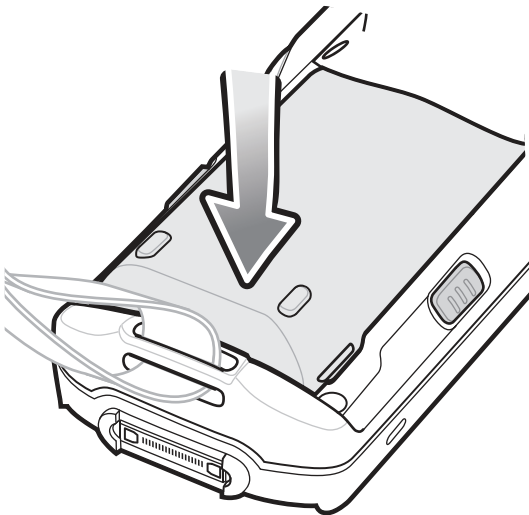

- 5 Tighten the handstrap.
- 6 Press the Power button to turn on the device.

- 7 On WinCE device with Rev B software, after boot up the calibration screen appears. Using the stylus, touch the targets as they appear on the screen.

Charging the Battery



Caution: Ensure that you follow the guidelines for battery safety described in [Battery Safety Guidelines on page 151](#).

Use the mobile computer cradles, cables and spare battery chargers to charge the mobile computer main battery.

The main battery can be charged before insertion into the mobile computer or after it is installed. There are two main batteries for the MC32N0, the Standard Battery (1X) and the Extended Life Battery (2X). The standard capacity battery ships from the factory in all MC32N0-R configurations. The Extended Life Battery ships from the factory in all MC32N0-S and MC32N0-G configurations. To install an Extended Life Battery in the MC32N0-R configurations, purchase an Extended Life Battery. Use one of the spare battery chargers to charge the main battery (out of the mobile computer) or one of the cradles to charge the main battery while it is installed in the mobile computer.

Before using the mobile computer for the first time, fully charge the main battery until the amber Charge LED Indicator remains lit (see [Table 7: LED Charge Indicators on page 31](#) for charge status indications). The Standard Battery fully charges in less than five hours and the Extended Life Battery fully charges in less than eight hours.

The MC32N0 retains data in memory for at least five minutes when the mobile computer's main battery is removed or fully discharged.

When the main battery reaches a very low battery state, the battery retains data in memory for at least 36 hours.

Batteries must be charged within the 0° to +40° C (32° to 104° F) ambient temperature range.

The following accessories can be used to charge batteries:

- Cradles (and a power supply):
 - Single Slot Serial/USB Cradle with Battery Adapter
 - Four Slot Cradles.
- Cables (and a power supply):
 - USB Client Charge Cable
 - Serial (RS232) Charge Cable.
- Spare Battery Chargers (and a power supply):
 - Four Slot Spare Battery Charger
 - Universal Battery Charger (UBC) Adapter with Battery Adapter.

To charge the mobile computer using the cradles:

1. Insert the mobile computer into a cradle. See [Accessories on page 127](#) for accessory setup.
2. The mobile computer starts to charge automatically. The amber Charge LED Indicator indicates the charge status. See the table below for charging indications.

To charge the mobile computer using the cables:

1. Connect the MC32N0 Communication/Charge Cable to the appropriate power source and connect to the mobile computer. See [Accessories on page 127](#) for accessory setup.
2. The mobile computer starts to charge automatically. The amber Charge LED Indicator indicates the charge status.

Table 7: LED Charge Indicators

Status	Indications
Off	MC32N0 is not charging.

Table continued...

Status	Indications
	MC32N0 is not inserted correctly in the cradle. MC32N0 is not connected to a power source. Charger or cradle is not powered.
Slow Blinking Amber	MC32N0 is charging.
Solid Amber	Charging complete. Note: When the battery is initially inserted in the mobile computer, the amber LED flashes once if the battery power is low.
Fast Blinking Amber	Charging error, e.g.: <ul style="list-style-type: none"> • Temperature is too low or too high. • Charging has gone on too long without completion (typically eight hours).

Charging Temperature

Charge batteries in ambient temperatures from 0 °C to 40 °C (32 °F to 104 °F) or up to 45 °C (113 °F) as reported by the battery. To view the battery temperature on Android devices, touch the **Battery Info** icon on the Home screen or

touch  >  **About device** > **Battery Information**.

Note that charging is intelligently controlled by the MC32N0. To accomplish this, for small periods of time, the MC32N0 or accessory alternately enables and disables battery charging to keep the battery at acceptable temperatures. The MC32N0 or accessory indicates when charging is disabled due to abnormal temperatures via its LED.

Charging Spare Batteries

See [Accessories on page 127](#) for information on using accessories to charge spare batteries.

Replacing the MC32N0-G Battery

Procedure:

- 1 Press the Power button until the menu appears.
 - 2 On Android device, touch **Battery swap**. Wait for the Scan LED to light red and then turn off. **3**
 - On WinCE device, touch **Safe Battery Swap**. Wait for the Scan LED to light red and then turn off. **4**
- Push in the two Battery Release buttons.

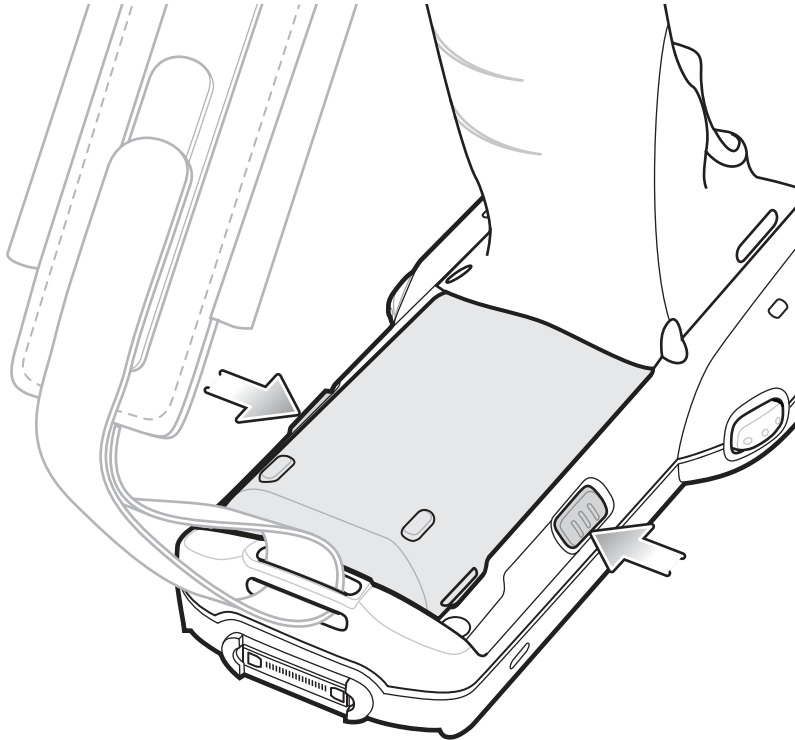
Figure 21: Release Battery

The battery ejects slightly.

- 5 Remove the battery from the battery compartment.

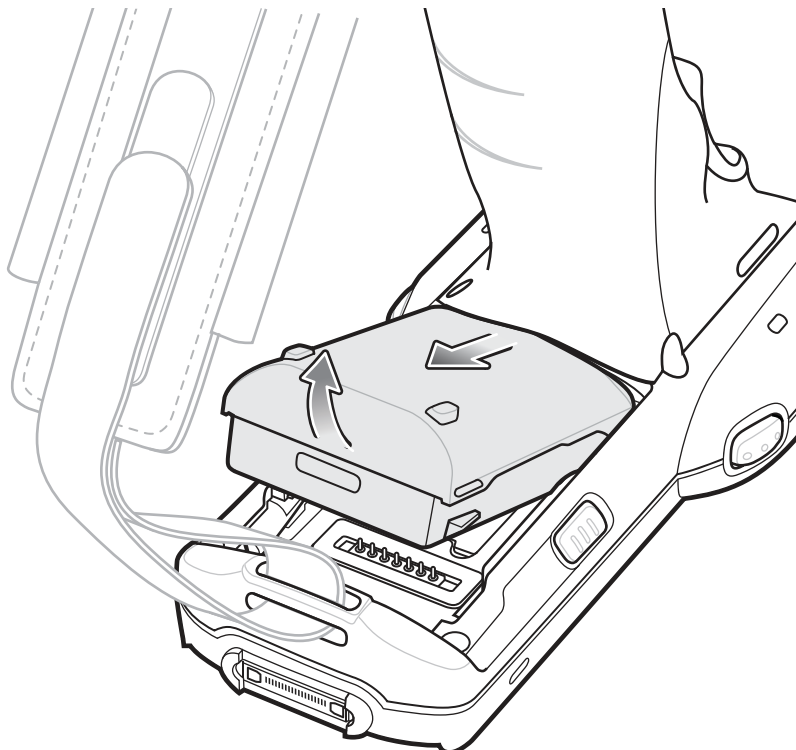
Figure 22: Remove Battery

- 6 Align the battery into the battery compartment.

Figure 23: Inserting the Battery

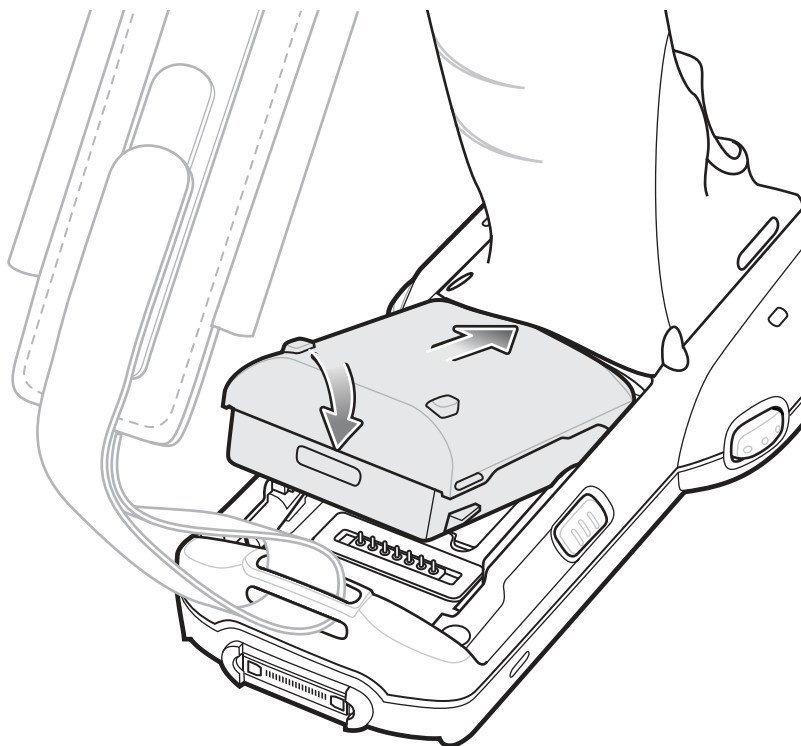

- 7 Rotate the bottom of the bottom into the battery compartment..
- 8 Press battery down firmly. Ensure that both battery release buttons on the sides of the MC32N0 return to the home position.

Figure 24: Press Battery Down

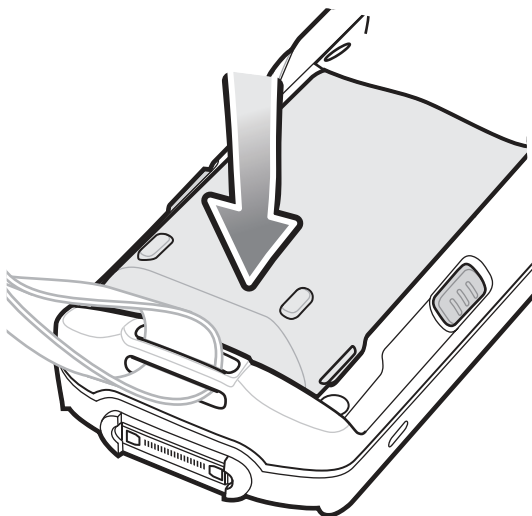

- 9 Press the Power button to turn on the device.

Replacing the MC32N0-R/S Battery

Procedure:

- 1 Press the Power button until the menu appears.
- 2 On Android device, touch **Battery swap**. Wait for the Scan LED to light red and then turn off.
- 3 On WinCE device, touch **Safe Battery Swap**. Wait for the Scan LED to light red and then turn off.
- 4 Loosen the handstrap and lift to access the battery.
- 5 Push in the two Battery Release buttons.

Figure 25: Release Battery

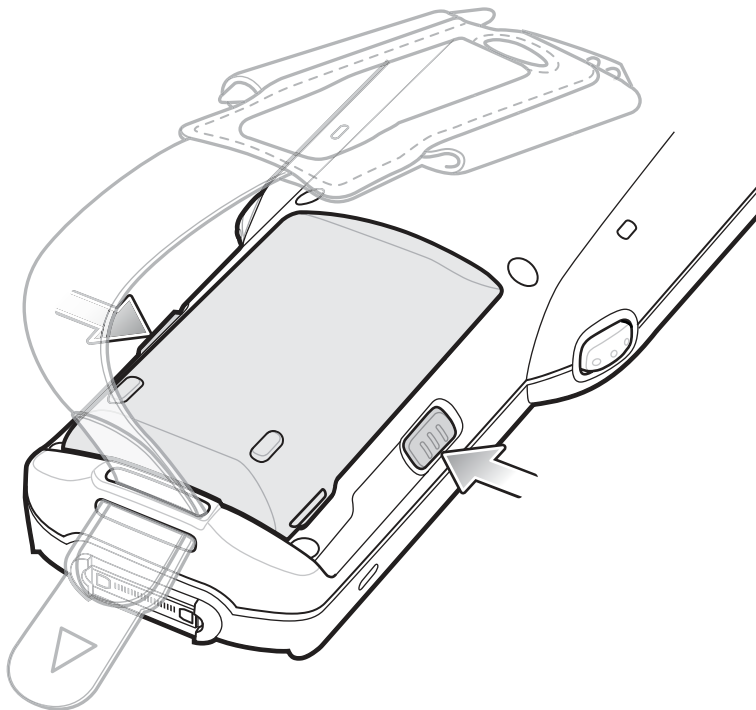

The battery ejects slightly.

- 6 Lift the battery out of the battery compartment.

Figure 26: Remove Battery

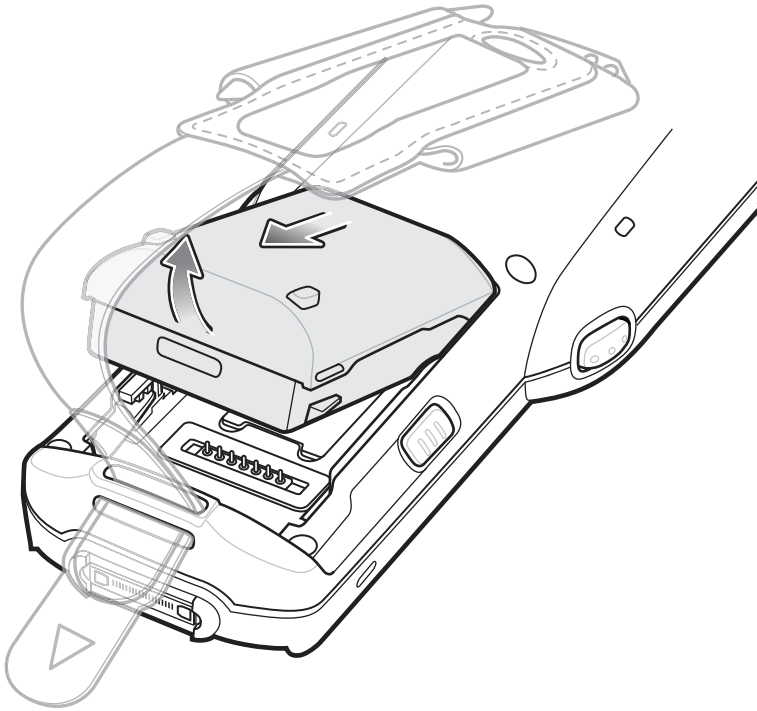

- 7 Align the top of the battery into the battery compartment.

Figure 27: Inserting the Battery

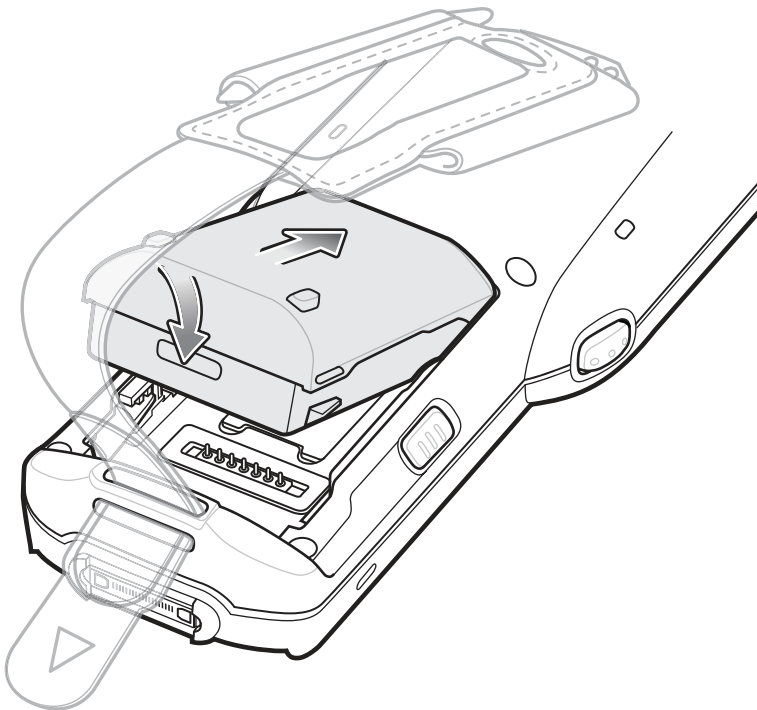

- 8 Rotate the bottom of the bottom into the battery compartment.
- 9 Press battery down firmly. Ensure that both battery release buttons on the sides of the MC32N0 return to the home position.

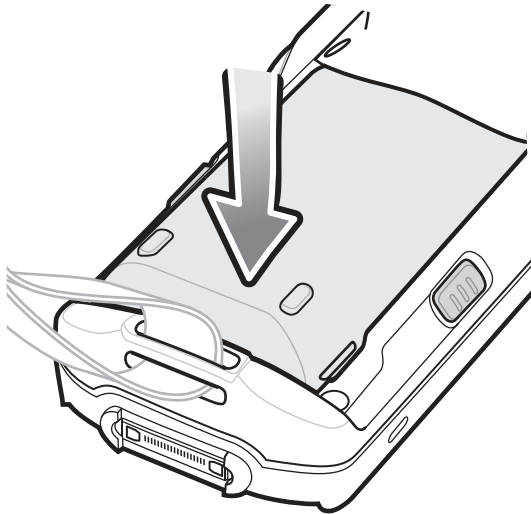
Figure 28: Press Battery Down



- 10 Tighten the handstrap.
- 11 Press the Power button to turn on the device.

Battery Management on Android™ Devices



Note:

Prior to checking the battery charge level, remove the MC32N0 from any AC power source (cradle or cable).

To check the charge status of the main battery, touch  >  **About device** > **Status**.

Battery status indicates that the battery is discharging and **Battery level** lists the battery charge (as a percentage of fully charged).

Monitor Battery Usage

The Battery Use screen lists which applications consume the most battery power. Also use it to turn off applications that were downloaded if they are consuming too much power.

Touch  >  **Battery**.

Figure 29: Battery Use Screen

The Battery Use screen lists the applications using the battery. The discharge graph at the top of the screen shows the rate of battery discharge since last charged (short periods of time when connected to a charger are shown as thin green lines at the bottom of the chart), and how long it has been running on battery power.

Touch an application in the Battery Use screen to display details about its power consumption. Different applications display different information. Some applications include buttons that open screens with settings to adjust power use.

Low Battery Notification

When the battery charge drops below 23% (Standard Capacity Battery) or 11% (Extended Capacity Battery), the MC32N0 displays a notice to connect the MC32N0 to power.

Figure 30: Low Battery Notification Screen

The user should replace the battery or charge the MC32N0 using one of the charging accessories.

When the battery charge drops below 17% (Standard Capacity Battery) or 8% (Extended Capacity Battery), the MC32N0 goes into critical suspend mode to save data. The screen turns off. If the Power button is pressed, the Right LED flashes amber.

The user must replace the battery or charge the MC32N0 using one of the charging accessories to retain data.

Battery Optimization

Observe the following battery saving tips:

- Leave the MC32N0 connected to AC power at all times when not in use.
- Set the screen to turn off after a short period of non-use.
- Reduce the screen brightness.

- Turn off all wireless radios when not in use.
- Turn off automatic syncing for Email, Calendar, Contacts, and other applications.
- Use the Power Control widget to check and control the status of radios, the screen brightness, and syncing.
- Minimize use of applications that keep the MC32N0 from suspending, for example, music and video applications.

Battery Management on WinCE Devices



Note:

Prior to checking the battery charge level, remove the MC32N0 from any AC power source (cradle or cable).

To check the charge status of the main battery, touch  > **Settings** > **Control Panel** > **Power**.

Figure 31: Power Settings — Battery Tab



Battery Power remaining lists the battery charge (as a percentage of fully charged).

Low Battery Notification

When the battery charge drops below 15% (default), the MC32N0 displays a notice to connect the MC32N0 to power.

Figure 32: Low Battery Notification Screen



The user should replace the battery or charge the MC32N0 using one of the charging accessories.

When the battery charge drops below 10%, the MC32N0 goes into critical suspend mode to save data. The screen turns off. If the Power button is pressed, the Right LED flashes amber.

The user must replace the battery or charge the MC32N0 using one of the charging accessories to retain data.

Battery Optimization

Observe the following battery saving tips:

- Leave the MC32N0 connected to AC power at all times when not in use.
- Set the screen to turn off after a short period of non-use.
- Reduce the screen brightness.
- Turn off all wireless radios when not in use.
- Turn off automatic syncing for Email, Calendar, Contacts, and other applications.
- Use the Power Control widget to check and control the status of radios, the screen brightness, and syncing.
- Minimize use of applications that keep the MC32N0 from suspending, for example, music and video applications.

Connecting a Wired Headset

To connect a wired headset to the MC32N0:

Figure 33: Connect Headset to MC32N0–R/S

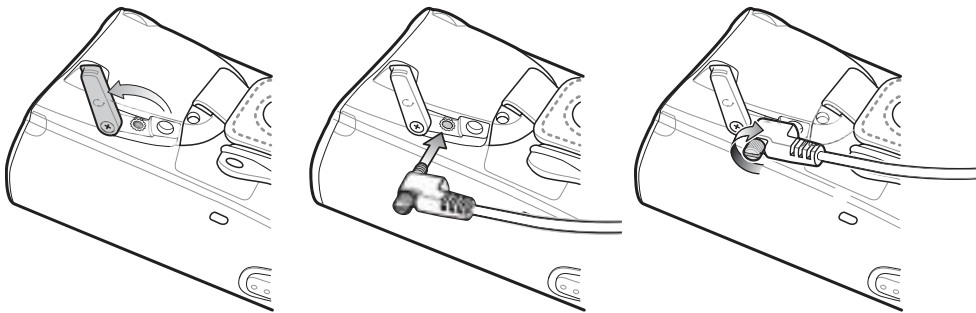
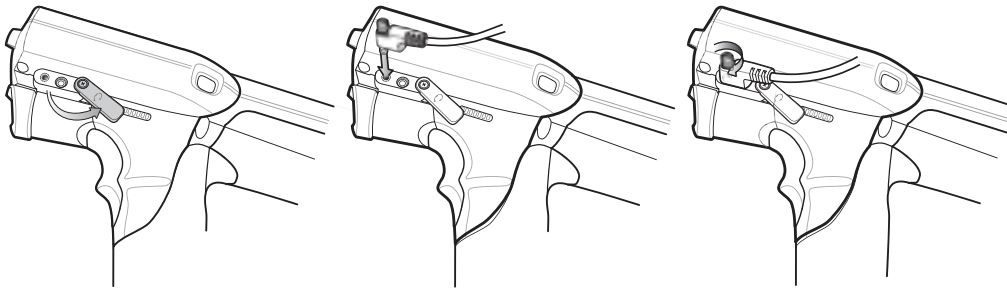

Figure 34: Connect Headset to MC32N0–G



Using a Bluetooth Headset

You can use a Bluetooth headset for audio communication when an audio enabled application is used. See [Bluetooth on page 78](#) for information on connecting a Bluetooth device to the mobile computer. Ensure that the mobile computer's volume is set appropriately before putting the headset on. When a Bluetooth headset is connected the speaker is muted.



Note: If the mobile computer goes into suspend mode the Bluetooth connection is disabled and the mobile computer automatically switches to speakerphone mode.

Real-Time Clock Backup

The MC32N0 provides a Real-time Clock (RTC) backup feature. After boot-up, the device saves the system time in a file in persistent storage. When the device re-boots, it compares the system time to the time saved in a file. If the system time is not the latest, it restores the time from the file.

Chapter 2

Using the MC32N0 with Android™

This chapter describes the screens, status and notification icons, and controls on the MC32N0, and provides basic instructions for using the MC32N0.

Home Screen

The Home screen displays when the MC32N0 turns on. Depending upon the configuration, the Home screen might appear different. Contact your system administrator for more information.



After a suspend or screen time-out, the Home screen displays with the lock sliders. Slide  to the right toward  to unlock the screen. For screen locking information see [Un-Locking the Screen on page 66](#).

Figure 35: Home Screen



Note: The Home screen icons can be configured by the user and may look different than shown.

The Home screen consists of the following:

Table 8: Home Screen Items

Item	Description
1 — Status Bar	Displays the time, status icons (right side), and notification icons (left side). For more information see Status Icons on page 44 and Managing Notifications on page 46 .

Table continued...

Item	Description
2 — Browser Icon	Opens the Browser application.
3 — All Apps Icon	Opens the APPS window.
4 — Settings Icon	Opens the Settings window.
5 — Shortcut Icons	Opens applications installed on the MC32N0. See <i>Application Shortcuts and Widgets on page 47</i> for more information.
6 — Widgets	Launches stand-alone applications that run on the Home screen. See <i>Application Shortcuts and Widgets on page 47</i> for more information.

The Home screen provides four additional screens for placement of widgets and shortcuts. Swipe the screen left or right to view the additional screens.

Status Bar

The Status bar displays the time, notification icons (left side) and status icons (right side).

Figure 36: Notification and Status Icons

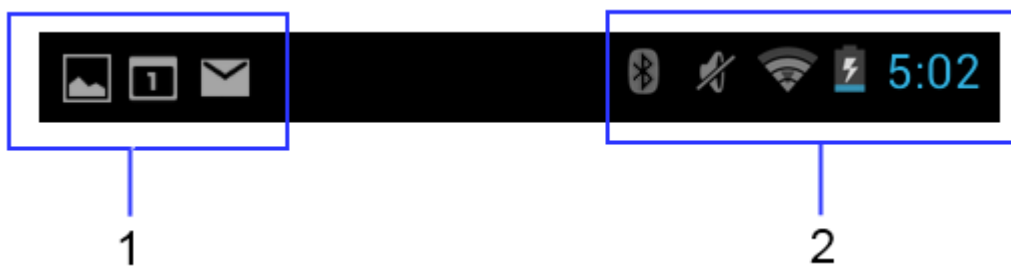

1	Notifications icons
2	Status icons

If there are more notifications than can fit in the Status bar,  displays indicating that more notifications exist. Open the Notifications panel to view all notifications and status.

Status Icons

Table 9: Status Icons







































Icon	Description
	Indicates that Bluetooth is on.
	Indicates that the device is connected to another Bluetooth device.
	Indicates that the Alarm is active.

Table continued...

Icon	Description
	Indicates that all sounds except media and alarms are silenced and vibrate mode is active.
	Indicates that the audio is silenced.
	Connected to a Wi-Fi network.
	No Wi-Fi signal.
	Indicates that the battery charge is very low.
	Indicates that the battery charge is low.
	Indicates that the battery is partially drained.
	Indicates that the battery is fully charged.
	Indicates that the battery is charging.
	Indicates that the MC32N0 is calculating the battery capacity level.
	Indicates an unknown charging error.
	Indicates that the battery temperature is nearing the high for charging to occur.
	Indicates that the battery temperature is nearing the low for charging to occur.
	Indicates that the Airplane Mode is active. All radios are turned off.
	Indicates that the Orange key is locked.
	Indicates that the Blue key is pressed.
	Indicates that the ALT key is pressed.
	Indicates that the CTRL key is pressed.
	Indicates that the Shift key is pressed.
	Indicates that the Shift key is locked.
	Indicates that a wired headset is connected to the MC32N0.
	Connected to an Ethernet network.

Notification Icons

Table 10: Notification Icons

Icon	Description
	Indicates that more notifications are available for viewing.
	Indicates that data is syncing.
	Indicates an upcoming event.
	Indicates that a problem with sign-in or sync has occurred.
	Indicates that the device is uploading data.
	Indicates that the microSD card is almost full.
	Indicates that the device is downloading data when animated and download is complete when static.
	Indicates that the device is connected via USB cable.
	Indicates that the device is connected to a virtual private network (VPN).
	Preparing microSD card.
	Indicates that USB debugging is enabled on the device.
	Screenshot captured.
	Error capturing screenshot.
	Indicates that the MultiUser feature is enabled.
	Indicates that a new user is logging in.

Managing Notifications

Notification icons report the arrival of new messages, calendar events, and alarms, as well as ongoing events. When a notification occurs, an icon appears in the Status bar with a brief description. See [Notification Icons on page 46](#) for a list of possible notification icons and their description. Open the **Notifications** panel to view a list of all the notifications.

To open the Notification panel, drag the Status bar down from the top of the screen.

Figure 37: Notification Panel

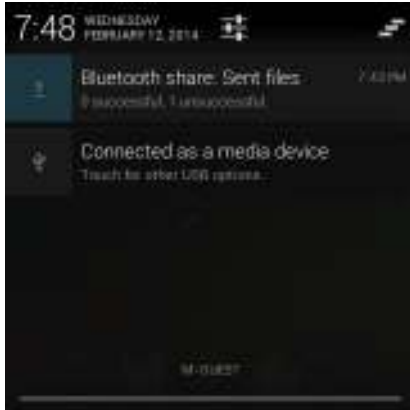

To respond to a notification, open the Notifications Panel and then touch a notification. The Notifications Panel closes and the subsequent activity is dependent on the notification.

To clear all notifications, open the Notifications Panel and then touch . All event-based notifications are removed. Ongoing notifications remain in the list.

To close the Notification Panel, drag the bottom of the Notifications Panel to the top of the screen or press .

Application Shortcuts and Widgets

Application shortcuts placed on the Home screen allow quick and easy access to applications. Widgets are self-contained applications placed on the Home screen to access frequently used features.

Adding an Application or Widget to the Home Screen

Procedure:

- 1 Go to the desired Home screen.
- 2 Touch .
- 3 Swipe right, if necessary, to find the application icon or widget.
- 4 Touch and hold the icon or widget until the Home screen appears.
- 5 Position the icon on the screen and then release.

Moving Items on the Home Screen

Procedure:

- 1 Touch and hold the item until it floats on the screen.
- 2 Drag the item to a new location. Pause at the edge of the screen to drag the item onto an adjacent Home screen.
- 3 Lift finger to place the item on the Home screen.

Removing an App or Widget from the Home Screen

Procedure:

- 1 Go to the desired Home screen.

- 2 Touch and hold the application shortcut or widget icon until it floats on the screen.
- 3 Drag the icon to  **Remove** on the top of the screen and then release.

Folders

Use **Folders** to organize similar applications together. Tap the folder to open and display items in the folder.

Creating Folders

Procedure:

- 1 Go to the desired Home screen.
- 2 Place at least two application shortcuts on the Home screen.
- 3 Touch and hold a shortcut until it floats on the screen.
- 4 Move the icon over another icon. A blue circle appears around the icons.

Figure 38: Stacked Shortcut Icons



- 5 Lift finger to stack the icons. The shortcut icons appear over a black circle.

Figure 39: Unnamed Folder



Naming Folders

Procedure:

- 1 Touch the folder.

Figure 40: Open Folder

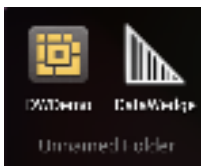

- 2 Touch the title area and enter a folder name using the keyboard.
- 3 Touch **Done**.
- 4 Touch anywhere on the Home screen to close the folder. The folder name appears under the folder.

Figure 41: Renamed Folder



Removing a Folder

Procedure:

- 1 Touch and hold the folder icon until it enlarges and the device vibrates.
- 2 Drag the icon to  **Remove** and release.

Home Screen Wallpaper



Note: Use of Live Wallpaper may reduce battery life.

Change the Home Screen Wallpaper

Procedure:

- 1 Touch and hold on the Home screen until the **Choose Wallpaper from** menu appears.
- 2 Touch **Gallery**, **Live wallpapers** or **Wallpapers**.
 - **Gallery** - Select to use an image stored on the device.
 - **Live wallpapers** - Select to use an animated wallpaper image.
 - **Wallpapers** - Select to use a wallpaper image.
- 3 Touch **Save** or **Set wallpaper**.

Using the Touchscreen

Use the screen to operate the device.

- **Touch** - Touch to:
 - select items on the screen
 - type letters and symbols using the on-screen keyboard
 - press on-screen buttons.
- **Touch and Hold** - Touch and hold:
 - an item on the Home screen to move it to a new location or to the trash.
 - an item in the **All Apps** screen to create a shortcut on the Home screen.
 - the Home screen to change the Home screen wallpaper.
- **Drag** - Touch and hold an item for a moment and then move finger on the screen until reaching the new position.
- **Swipe** - Move finger up and down or left and right on the screen to:
 - unlock the screen
 - view additional Home screens
 - view additional application icons in the **All Apps** screen
 - view more information on an application's screen.
- **Double-tap** - Tap twice on a web page, map, or other screen to zoom in and out.

Using the On-screen Keyboard

Use the on-screen keyboard to enter text in a text field. To configure the keyboard settings, touch  (comma) >





and then select **Android keyboard settings**.

Editing Text

Edit entered text and use menu commands to cut, copy, and paste text within or across applications. Some applications do not support editing some or all of the text they display; others may offer their own way to select text.

Entering Numbers, Symbols and Special Characters

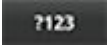
To enter numbers and symbols:

- Touch and hold one of the top-row keys until a menu appears then select a number. Keys with alternate characters display an ellipsis (...) below the character.
- Touch and hold the Shift key with one finger, touch one or more capital letters or symbols to enter them, and then lift both fingers to return to the lowercase keyboard.
- Touch  to switch to the numbers and symbols keyboard.
- Touch the  key on the numbers and symbols keyboard to view additional symbols.

To enter special characters, touch and hold a number or symbol key to open a menu of additional symbols.

- A larger version of the key displays briefly over the keyboard.
- Keys with alternate characters display an ellipsis (...) below the character.

Applications

The **APPS** screen displays icons for all installed applications. The table below lists the applications installed on the MC32N0. Refer to the *MC32N0 Integrator Guide* for information on installing and uninstalling application.

Table 11: Applications



Icon	Description
	Battery Info – Displays the Battery Information screen.
	Bluetooth Pairing – Use to pair the RS507 Hands-free imager with the MC32N0 by scanning a bar code.
	Browser - Use to access the Internet or intranet.

Table continued...

























Icon	Description
	Calculator - Provides the basic and scientific arithmetic functions.
	Calendar - Use to manage events and appointments.
	Clock - Use to schedule alarms for appointments or as a wake-up.
	DataWedge - Enables data capture using the camera or optional scanner.
	Downloads - lists all downloads files.
	DWDemo - Provides a way to demonstrate the data capture features using the Linear Imager. See DataWedge Demonstration on page 61 for more information.
	Email - Use to send and receive email.
	File Browser - Organize and manage files on the MC32N0. See File Browser on page 53 for more information.
	Gallery - Use to view photos stored on the microSD card. For more information, see Gallery on page 55 for more information.
	MLog Manager - Use to capture log files for diagnostics. See MLog Manager on page 62 for more information.
	Mobi Control Stage – Opens the Mobi Control Stage application to stage the MC32N0.
	MSP Agent - Enables management of the MC32N0 from an MSP server. Requires the purchase of an appropriate MSP client license per device to suit the level of management functionality required.
	Music - Play music stored on the microSD card.
	People - Use to manage contact information. People on page 54 for more information.

Table continued...

Icon	Description
	PTT Express – Use to launch the PTT Express client for Voice over IP (VoIP) communication.
	Rapid Deployment - Allows the MC32N0 to stage a device for initial use by initiating the deployment of settings, firmware and software. Requires the purchase of an MSP client license per device.
	RxLogger – Use to diagnose device and application issues. See the <i>MC32N0 Integrator Guide</i> for more information.
	Search - Use the Google search engine to search the Internet and the MC32N0.
	Settings - Use to configure the MC32N0.
	Sound Recorder - Use to record audio.
	Terminal Emulation – Opens Wavelink Terminal Emulation application.
	AppLock Administrator - Use to configure the Application Lock feature. This icon appears after the optional MX feature is installed.
	MultiUser Administrator - Use to configure the MultiUser feature. This icon appears after the optional MX feature is installed.
	Secure Storage Administrator - Use to configure the Secure Storage feature. This icon appears after the optional MX feature is installed.

Accessing Applications

All applications installed on the device are accessed using the **APPS** window.

Procedure:

- 1 On the Home screen touch . The **APPS** window displays.

Figure 42: APPS Window

- Slide the **APPS** window left or right to view more application icons. Touch an icon to open the application.



Note: See *Application Shortcuts and Widgets on page 47* for information on creating a shortcut on the Home screen.

Switching Between Recent Applications

Procedure:

- Press and hold . A window appears on the screen with icons of recently used applications.

Figure 43: Recently Used Applications

- Slide the window up and down to view all recently used applications.
- Swipe left or right to remove application from the list and force close the application.
- Touch an icon to open it or press to return to the current screen.

File Browser

Use the **File Browser** application to view and manage files on the device.

To open **File Browser**, touch > .

Figure 44: File Browser Screen

The address bar (1) indicates the current folder path. Touch the current folder path to manually enter a path and folder name.

Use  (2) to select multiple files/folder.

Use  (3) to view the internal storage root folder.

Use  (4) to view the microSD card root folder.

Use  (5) to view the previous folder or to exit the application.

Touch and hold an item to perform an operation on that item. Select one of the options from the **File Operations** menu:

- **Information** - View detailed information about the file or folder.
- **Move** - Move the file or folder to a new location.
- **Copy** - Copy the select file.
- **Delete** - Delete the selected file.
- **Rename** - Rename the select file.
- **Open as** - Open the selected file as a specific file type.
- **Share** - Share the file with other devices.

People

Use the **People** application to manage contacts.

From a Home or **Apps** screen, touch . **People** opens to the main list of contacts. View contacts in three ways at the top of the screen: Groups, All contacts, and Favorites. Touch the tabs to change how to view the contacts. Swipe up or down to scroll through the lists.

Adding People



Procedure:

- 1 In the **People** application, touch .
- 2 If there are more than one account with contacts, touch the one to use.

- 3 Type the contact's name and other information. Touch a field to start typing, and swipe down to view all categories.
- 4 To add more than one entry for a category – for example, to add a work address after typing a personal address – touch **Add new** for that field. To open a menu with preset labels, such as Home or Work for an email address, touch the label to the right of the item of contact information. Or, to create your own label, touch **Custom** in the menu.
- 5 Touch **Done**.



Editing People

Procedure:

- 1 In the **People** application, touch  tab.
- 2 Touch a person to edit.
- 3 Press .
- 4 Touch **Edit**.
- 5 Edit the contact information.
- 6 Touch **Done**.

Deleting People

Procedure:

- 1 In the **People** application, touch  tab.
- 2 Touch a person to edit.
- 3 Press .
- 4 Touch **Delete**.
- 5 Touch **OK** to confirm.

Gallery





Note:

The device supports the following image formats: jpeg, gif, png and bmp.

The device supports the following video formats: H.263, H.264 and MPEG4 Simple Profile.

Use **Gallery** to:

- view photos
- play videos
- perform basic editing of photos
- set photos as wallpaper
- set photos as a contact photo
- share photos and videos.

To open the Gallery application, touch  >  or in the camera application touch the thumbnail image at the top right.

Gallery presents all photos and videos stored on the microSD card.

Figure 45: Gallery — Albums

- Touch an album to open it and view its contents. The photos and videos in the album are displayed in chronological order.
- Touch a photo or video in an album to view it.
- Touch  icon (top left corner) to return to the main **Gallery** screen.

Working with Albums



Albums are groups of images and videos in folders. Touch an album to open it. The photos and videos are listed in a chronologically ordered grid. The name of the album displays at the top of the screen.



Figure 46: Photos Inside an Album

Swipe left or right to scroll images across the screen.

Share an Album



Procedure:

- 1 Touch .
- 2 Touch .
- 3 Touch and hold an album until it highlights.
- 4 Touch other albums as required.

- 5  Touch . The Share menu opens. Touch the application to use to share the selected albums.
- 6 Follow the instructions within the selected application.

Get Album Information



Procedure:

- 1 Touch .
- 2 Touch .
- 3 Touch and hold an album until it highlights.
- 4 Touch .
- 5 Touch **Details**.

Deleting an Album

To delete an album and its contents from the microSD card:

Procedure:

- 1 Touch .
- 2 Touch .
- 3 Touch and hold an album until it highlights.
- 4 Check other albums to delete. Ensure that other albums are selected.
- 5 Touch .
- 6 In the **Delete selected item?** menu, touch **OK** to delete the album.

Working with Photos

Use **Gallery** to view photos on the microSD card and edit and share photos.

Viewing and Browsing Photos

To view a photo:

Procedure:



- 1 Touch .
- 2 Touch .
- 3 Touch an album to open it.
- 4 Touch a photo.

Figure 47: Photo Example

- 5 Swipe left or right to view the next or previous photo in the album.
- 6 Turn the device to view the photo in upright (portrait) or sideways (landscape) orientation. The photo is displayed (but not saved) in the new orientation.
- 7 Touch the photo to view the controls.
- 8 Double-tap the screen to zoom in or pinch two fingers together or spread them apart to zoom in or out.
- 9 Drag the photo to view parts that are not in view.

Rotating a Photo

Procedure:

- 1 Touch a photo to view the controls.
- 2 Press .
- 3 Touch **Rotate Left** or **Rotate Right**.
The photo is automatically saved with the new orientation.

Cropping a Photo

Procedure:





- 1 In **Gallery**, touch a photo to view the controls.
- 2 Press .
- 3 Touch **Crop**. The blue cropping tool appears.
- 4 Use the cropping tool to select the portion of the photo to crop.
 - Drag from the inside of the cropping tool to move it.
 - Drag an edge of the cropping tool to resize it to any proportion.
 - Drag a corner of the cropping tool to resize it with fixed proportions.

Figure 48: Cropping Tool

- 5 Touch **OK** to save a copy of the cropped photo. The original version is retained.



Setting a Photo as a Contact Icon

Procedure:

- 1 Touch .
- 2 Touch .
- 3 Touch an album to open it.
- 4 Touch the photo to open it.
- 5 Touch .
- 6 Touch **Set picture as**.
- 7 Touch **Contact photo**.
- 8 In the **People** application, touch a contact.
- 9 Touch the blue box and crop the photo accordingly.
- 10 Touch **OK**.

Get Photo Information



Procedure:

- 1 Touch .
- 2 Touch .
- 3 Touch an album to open it.
- 4 Touch the photo to open it.
- 5 Touch .
- 6 Touch **Details**.
- 7 Touch **Close**.

Share a Photo



Procedure:

- 1 Touch .

- 2 Touch .
- 3 Touch an album to open it.
- 4 Touch a photo to open it.
- 5 Touch .
- 6 Touch the application to use to share the selected photo. The application selected opens with the photo attached to a new message.

Deleting a Photo

Procedure:

- 1 Touch .
- 2 Touch .
- 3 Touch an album to open it.
- 4 Touch a photo to open it.
- 5 Touch .
- 6 Touch **OK** to delete the photo.

Working with Videos

Use **Gallery** to view videos on the microSD card and share videos.

Watching Videos

Procedure:







- 1 Touch .
- 2 Touch .
- 3 Touch an album to open it.
- 4 Touch a video.
- 5 Touch . The video begins to play.

Figure 49: Video Example

- 6 Touch the screen to view the playback controls.



Sharing a Video

Procedure:

- 1 Touch .
- 2 Touch .
- 3 Touch an album to open it.
- 4 Touch a video to open it.
- 5 Touch . The Share menu appears.
- 6 Touch the application to use to share the selected video. The application selected opens with the video attached to a new message.

Deleting a Video

Procedure:

- 1 Touch .
- 2 Touch .
- 3 Touch an album to open it.
- 4 Touch a video to open it.
- 5 Touch .
- 6 Touch **OK**.

DataWedge Demonstration

Use **DataWedge Demonstration** to demonstrate data capture functionality.

Figure 50: DataWedge Demonstration Window**Table 12: DataWedge Demonstration Icons**

Icon	Description
	Not applicable.
	Indicates that the data capture function is through the imager.
	Toggles between normal scan mode and picklist mode when using the imager to capture bar code data.
	Opens a menu to view the application information or to set the application DataWedge profile.

**Note:**

See the *MC32N0 Integrator Guide* for information on DataWedge configuration.

Either press a Scan key or touch the yellow scan button in the application to enable data capture. The captured data appears in the text field below the yellow button.

MLog Manager

Use **MLog Manager** to capture log files for diagnostics. See the *MC32N0 Integrator Guide* for detailed information on configuring the application.

Figure 51: MLog Manager

Sound Recorder

Use **Sound Recorder** to record audio messages.

Recordings are saved on the microSD card (if installed) or the Internal Storage and available in the Music application playlist titled "My Recordings."

Figure 52: Sound Recorder Application



PTT Express Voice Client



Note:

PTT Express Voice Client creates Push-To-Talk (PTT) communication capability between disparate enterprise devices. Leveraging existing Wireless Local Area Network (WLAN) infrastructure, PTT Express delivers simple PTT communication without the need of a voice communication server.

- **Group Call:** Press and hold the Talk button (yellow Scan button on the MC32N0-G keypad or the right Scan button on MC32N0-R/S) to start communicating with other voice client users.
- **Private Response:** Press and release and then press and hold the Talk button to respond to the originator of the last group call.

PTT Audible Indicators

The following tones provide helpful cues when using the voice client.

- **Talk Tone:** Double chirp. Plays when the Talk button is depressed. This is a prompt for the user to start talking.
- **Access Tone:** Single beep. Plays when another user just finished a broadcast or response. The user is now able to initiate a Group Broadcast.
- **Busy Tone:** Continuous tone. Plays when the Talk button is depressed and another user is already communicating on the same talkgroup. Plays after the maximum allowed talk time is reached (60 seconds).
- **Network Tone:**
 - Three increasing pitch beeps. Plays when PTT Express has acquired the WLAN connection and the service is enabled.
 - Three decreasing pitch beeps. Plays when PTT Express has lost the WLAN connection or the service is disabled.

Figure 53: PTT Express Default User Interface**Table 13: PTT Express Default user Interface Descriptions**

Item	Description
Notification Icon	Indicates the current state of the PTT Express client.
Service Indication	Indicates the status of the PTT Express client. Options: Service Enabled , Service Disabled or Service Unavailable .
Previous Profile Button	Scrolls to the previous profile screen.
Talk Group	Lists Talk Groups available for PTT communication.
Speaker Icon	Mutes and un-mutes the client. If muted, a call cannot be heard and initiated.
Settings	Opens the PTT Express Settings screen.
Enable/Disable Switch	Turns the PTT service on and off.
Next Profile Button	Scrolls to the next profile screen.
Profile Enable/Disable Checkbox	Indicates that the profile is enabled (checked) or disabled (unchecked).
Profile Name	Displays the name of the current profile.

Enabling PTT Communication

Procedure:

- 1 Touch .
- 2 Touch .

Figure 54: PTT Express Window

- 3 Slide the **Enable/Disable Switch** to the **ON** position. The button changes to an **ON** button.

PTT Communication



Note: This section describes the default PTT Express client configuration. See the *PTT Express V1.2 User Guide* for detailed information on using the client.

PTT communication may be established as a Group Call. When PTT Express is enabled, the yellow Scan button on the keypad is assigned for PTT communication.

Creating a Group Call

Procedure:

- 1 Press and hold the Scan button and listen for the talk tone to play.
If a busy tone is heard, release the button and wait a moment before making another attempt. Ensure that PTT Express and the WLAN are enabled.
- 2 Start talking after the talk tone is heard.



Note: If the user holds the button for more than 60 seconds (default), the call is dropped allowing others to make Group calls. The user should release the button when finished talking to allow others to make calls.

- 3 Release the button when finished talking.

Responding with a Private Response



The Private Response can only be initiated once a Group Call has been established. The initial Private Response is made to the originator of the Group Call.

Procedure:

- 1 Wait until an access tone is heard.
- 2 Press and release and then press and hold the Talk button and listen for the talk tone to play.
If a busy tone is heard, release the button and wait a moment before making another attempt. Ensure that PTT Express and the WLAN are enabled.
- 3 Start talking after the talk tone plays.
- 4 Release the button when finished talking.

Disabling PTT Express Voice Client Communication

Procedure:

- 1 Touch .
- 2 Touch .
- 3 Slide the **Enable/Diable Switch** to the **OFF** position. The button changes to **OFF**.
- 4 Touch .

Un-Locking the Screen

Use the Lock screen to protect access to data on the MC32N0. Some email account require locking the screen. Refer to the *MC32N0 Integrator Guide* for information on setting up the locking feature. The Locking feature functions differently in Single User mode or Multiple User mode.

Single User Mode

When locked, a PIN or password is required to unlock the device. Press the Power button to lock the screen. The device also locks after a pre-defined time-out.

Press and release the Power button to wake the device.

The Lock screen displays. Slide  up to unlock the screen.

If the PIN or Password screen unlock feature is enabled, enter the PIN or password after unlocking the screen.

Figure 55: Lock Screen



Figure 56: PIN Screen**Figure 57: Password Screen**

MultiUser Mode

With MultiUser login, multiple users can log on to the device with each user having access to various applications and features. When enabled, the Login screen appears after powering on, resetting or after the device wakes from suspend mode.

MultiUser Login

Procedure:

- 1 In the **Login** text field, enter the username.

Figure 58: Multiple User Log In Screen

- 2 In the **Password** text field, enter the password.
- 3 Touch **OK**. After a resume from suspend, the user must enter the password.

MultiUser Logout

Procedure:

- 1 Drag the Status Bar down from the top of the screen.
- 2 Touch **MultiUser is active**.
- 3 Touch **Logout**.
- 4 The **Login** screen appears.

Resetting the Android Device

There are two reset functions, soft reset and hard reset.

Performing a Soft Reset

Perform a soft reset if applications stop responding.

Procedure:

- 1 Press and hold the Power button until the menu appears.
- 2 Touch **Reset**.
- 3 The device reboots.

Performing a Hard Reset



Note: All un-saved data is lost after performing a Hard Reset.

Perform a Hard Reset if the device stops responding. To perform a Hard Reset:



Procedure:

- 1 Simultaneously press the Power button, 1 and 9 keys.
- 2 The device reboots.

Suspend Mode

The MC32N0 goes into suspend mode when the user presses the Power button or after a period of inactivity (set in the Display settings window).

To wake the MC32N0 from Suspend mode, press the Power button.

The Lock screen displays. Slide  to the right toward  to unlock the screen. See [Un-Locking the Screen on page 66](#).



Note:

If the user enters the PIN, password or pattern incorrectly five times, they must wait 30 seconds before trying again.

If the user forgets the PIN, password or pattern contact the system administrator.



Figure 59: Lock Screen



Setting the Date and Time

The date and time is automatically synchronized using an NITZ server when the MC32N0 is connected to a wireless network. The user is only required to set the time zone or set the date and time when not connected to a wireless network.

Procedure:

- 1 Touch .
- 2 Touch  **Date & time**.
- 3 Touch **Automatic date & time** to disable automatic date and time synchronization.
- 4 Touch **Automatic time zone** to disable automatic time zone synchronization.
- 5 Touch **Set date**.
- 6 Move the sliders up and down to select the month, date and year.
- 7 Touch **Done**.
- 8 Touch **Set time**.
- 9 Move the sliders up and down to select the hour, minutes and part of the day.
- 10 Touch **Done**.

- 11 Touch **Select time zone**.
- 12 Select the current time zone from the list.
- 13 Press .

Display Setting

Use Display settings to change the screen brightness, change the background image, set sleep time and change font size.

Setting the Screen Brightness

Procedure:

- 1 Touch .
- 2 Touch  **Display**.
- 3 Touch **Brightness**.

Figure 60: Brightness Dialog Box





- 4 Use the slider to set a brightness level.
- 5 Touch **OK**.
- 6 Press .

Changing the Screen Timeout Setting

To set the MC32N0 to turn off after a short period of non-use:

Procedure:

- 1 Touch .
- 2 Touch  **Display**
- 3 Touch **Sleep**
- 4 Select a value from the **Sleep** window. Options:
 - **15 seconds**
 - **30 seconds**
 - **1 minute** (default)
 - **2 minutes**
 - **5 minutes**
 - **10 minutes**
 - **30 minutes**
- 5 Press .

General Sounds Setting



Use the **Sounds** settings to configure media and alarm volumes. Touch  >  >  **Sounds**.

Figure 61: Sounds Screen



- **Volumes** — Use to change the volume of media, notifications and alarms.

Figure 62: Volumes Dialog Box



- **System**
 - **Default notification** - Touch to select a sound to play for all system notifications.
 - **Touch sounds** - Check to play a sound when making screen selections.
 - **Screen lock sounds** - Check to play a sound when locking and unlocking the screen.

Calibration Screen



Note: Available on devices with Rev B software.

Use the Calibration screen to align the touch screen:

Procedure:

- 1 Remove the stylus from the stylus holder.

2

Touch  > **Display** > **Touch Calibration**.

3 Carefully press and briefly hold the stylus tip on the center of the Calibration screen target. Repeat the procedure as the target moves and stops at different locations on the screen. This enters the new calibration settings.

Figure 63: Calibration Screen

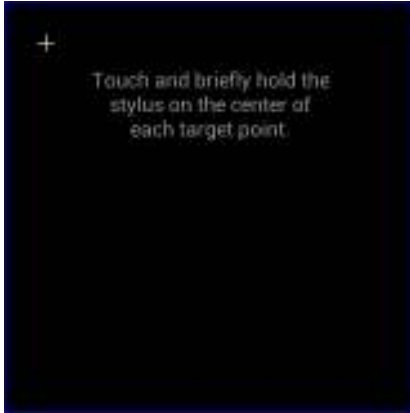

Wireless Local Area Networks

Wireless local area networks (WLANs) allow the MC32N0 to communicate wirelessly inside a building. Before using the MC32N0 on a WLAN, the facility must be set up with the required hardware to run the WLAN (sometimes known as infrastructure). The infrastructure and the MC32N0 must both be properly configured to enable this communication.

Refer to the documentation provided with the infrastructure (access points (APs), access ports, switches, Radius servers, etc.) for instructions on how to set up the infrastructure.

Once the infrastructure is set up to enforce the chosen WLAN security scheme, use the **Wireless & networks** settings to configure the MC32N0 to match the security scheme.

The MC32N0 supports the following WLAN security options:

- Open
- Wireless Equivalent Privacy (WEP)
- Wi-Fi Protected Access (WPA)/WPA2 Personal (PSK)
- Extensible Authentication Protocol (EAP)
 - LEAP
 - FAST - with Microsoft Challenge-Handshake Authentication Protocol version 2 (MSCHAPv2) and Generic Token Card (GTC) authentication.
 - Protected Extensible Authentication Protocol (PEAP) - with MSCHAPv2 and GTC authentication.
 - Transport Layer Security (TLS)
 - TTLS - with Password Authentication Protocol (PAP), MSCHAP and MSCHAPv2 authentication.

The **Status** bar displays icons that indicate Wi-Fi network availability and Wi-Fi status. See [Status Bar on page 44](#) for more information.



Note: Turn off Wi-Fi when not using it, to extend the life of the battery.

Scan and Connect to a Wi-Fi Network

Procedure:



- 1 Touch .
- 2 Touch .

Figure 64: Settings Screen



- 3 Slide the **Wi-Fi** switch to the **ON** position.
- 4 Touch  **Wi-Fi**. The MC32N0 searches for WLANs in the area and lists them.

Figure 65: Wi-Fi Screen



- 5 Scroll through the list and select the desired WLAN network.
- 6 For open networks, touch profile once or press and hold and then select **Connect to network** or for secure networks enter the required password or other credentials then touch **Connect**. See the system administrator for more information.

The MC32N0 obtains a network address and other required information from the network using the dynamic host configuration protocol (DHCP) protocol. To configure the MC32N0 with a fixed internet protocol (IP) address, See [Configuring the Device to Use a Static IP Address on page 76](#).

- 7 In the Wi-Fi setting field, **Connected** appears indicating that the MC32N0 is connected to the WLAN.

Configuring a Wi-Fi Network

To set up a Wi-Fi network:

Procedure:





- 1 Touch .
- 2 Touch .
- 3 Touch  **Wi-Fi**.
- 4 Slide the switch to the **ON** position.
- 5 The device searches for WLANs in the area and lists them on the screen.
- 6 Scroll through the list and select the desired WLAN network.
- 7 Touch the desired network. If the network security is **Open**, the device automatically connects to the network. For all other network security a dialog box appears.

Figure 66: WLAN Network Security Dialog Box

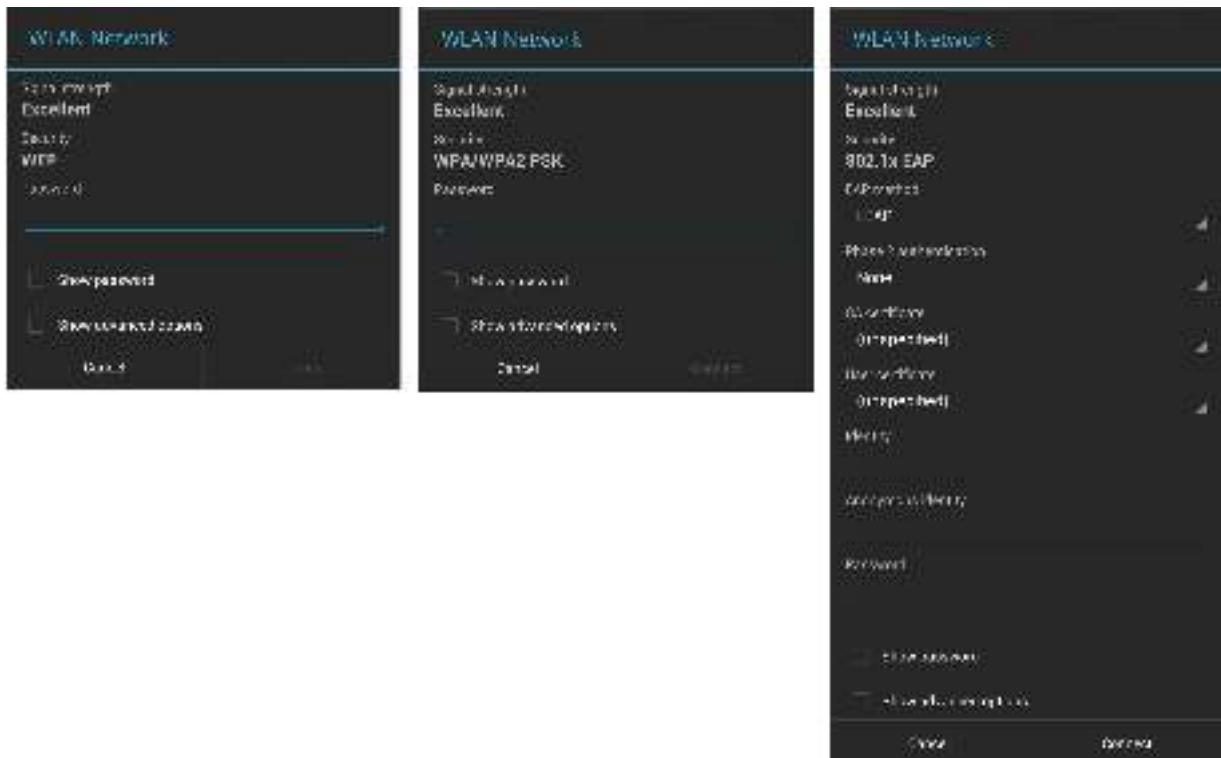

- 8 If the network security is **WEP** or **WPA/WPS2 PSK**, enter the required password and then touch **Connect**.
- 9 If the network security is 802.1x EAP:
 - Touch the EAP method drop-down list and select **PEAP**, **TLS**, **TTLS** or **PWD**.
 - Touch the **Phase 2 authentication** drop-down list and select an authentication method.
 - If required, touch **CA certificate** and select a Certification Authority (CA) certificate. Note: Certificates are installed using the **Security** settings.
 - If required, touch **User certificate** and select a user certificate. Note: User certificates are installed using the **Location & security** settings.
 - If required, in the **Identity** text box, enter the username credentials.
 - If desired, in the **Anonymous identity** text box, enter an anonymous identity username.
 - If required, in the **Password** text box, enter the password for then given identity.

- 10  **Note:** By default, the network Proxy is set to **None** and the IP settings is set to **DHCP**. See [Configuring for a Proxy Server on page 75](#) for setting connection to a proxy server and see [Configuring the Device to Use a Static IP Address on page 76](#) for setting the device to use a static IP address.



Touch **Connect**.

- 11 Press .

Manually Adding a Wi-Fi Network

Manually add a Wi-Fi network if the network does not broadcast its name (SSID) or to add a Wi-Fi network when out of range.

Procedure:

- 1 Touch .
- 2 Touch  **Wi-Fi**.
- 3 Slide the Wi-Fi switch to the **On** position.
- 4 In the **Network SSID** text box, enter the name of the Wi-Fi network.
- 5 In the **Security** drop-down list, select the type of security. Options:
 - **None**
 - **WEP**
 - **WPA/WPA2 PSK**
 - **802.1x EAP**.
- 6 If the network security is **None**, touch **Save**.
- 7 If the network security is **WEP** or **WPA/WPA2 PSK**, enter the required password and then touch **Save**.
- 8 If the network security is **802.1x EAP**:
 - Touch the **EAP method** drop-down list and select **PEAP**, **TLS** or **TTLS**.
 - Touch the **Phase 2 authentication** drop-down list and select an authentication method.
 - If required, touch **CA certificate** and select a Certification Authority (CA) certificate. Note: Certificates are installed using the **Security** settings.
 - If required, touch **User certificate** and select a user certificate. Note: User certificates are installed using the **Security** settings.
 - If required, in the **Identity** text box, enter the username credentials.
 - If desired, in the **Anonymous** identity text box, enter an anonymous identity username.
 - If required, in the **Password** text box, enter the password for then given identity.
- 9  **Note:** By default, the network Proxy is set to **None** and the IP settings is set to **DHCP**. See [Configuring for a Proxy Server on page 75](#) for setting connection to a proxy server and see [Configuring the Device to Use a Static IP Address on page 76](#) for setting the device to use a static IP address.

Touch **Connect**.

- 10 Press .

Configuring for a Proxy Server

A proxy server is a server that acts as an intermediary for requests from clients seeking resources from other servers. A client connects to the proxy server, requesting some service, such as a file, connection, web page, or other resource, available from a different server. The proxy server evaluates the request according to its filtering rules. For example, it may filter traffic by IP address or protocol. If the request is validated by the filter, the proxy provides the resource by connecting to the relevant server and requesting the service on behalf of the client.

It is important for enterprise customers to be able to set up secure computing environments within their companies, and proxy configuration is an essential part of doing that. Proxy configuration acts as a security barrier ensuring that

the proxy server monitors all traffic between the Internet and the intranet. This is normally an integral part of security enforcement in corporate firewalls within intranets.

Procedure:

- 1 In the network dialog box, touch a network.
- 2 Touch **Show advanced options** checkbox.
- 3 Touch **Proxy settings** and select **Manual**.

Figure 67: Proxy Settings

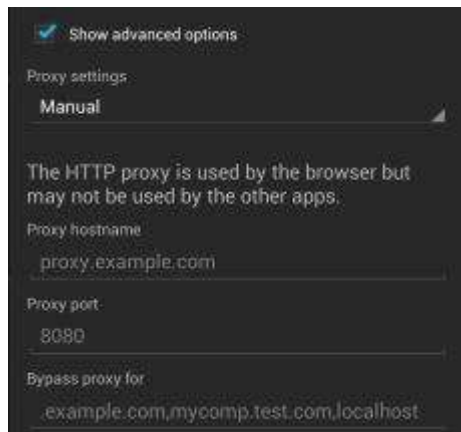

- 4 In the **Proxy hostname** text box, enter the address of the proxy server.
- 5 In the **Proxy port** text box, enter the port number for the proxy server.



Note: When entering proxy addresses the **Bypass proxy for** field, do not use spaces or carriage returns between addresses.

- 6 In the **Bypass proxy for** text box, enter addresses for web sites that do not require to go through the proxy server. Use the separator “|” between addresses.
- 7 Touch **Connect**.
- 8 Press .

Configuring the Device to Use a Static IP Address

By default, the device is configured to use Dynamic Host Configuration Protocol (DHCP) to assign an Internet protocol (IP) address when connecting to a wireless network. To configure the device to connect to a network using a static IP address:

Procedure:

- 1 In the network dialog box, touch a network.
- 2 Touch **Show advanced options** checkbox.
- 3 Touch **IP settings** and select **Static**.

Figure 68: Static IP Settings

- 4 In the **IP address** text box, enter an IP address for the device.
- 5 If required, in the **Gateway** text box, enter a gateway address for the device.
- 6 If required, in the **Network prefix length** text box, enter a the prefix length.
- 7 If required, in the **DNS 1** text box, enter a Domain Name System (DNS) address.
- 8 If required, in the **DNS 2** text box, enter a DNS address.
- 9 Touch **Connect**.
- 10 Press .

Advanced Wi-Fi Settings



Note: Advanced Wi-Fi settings are for the device not for a specific wireless network.

Use the **Advanced** settings to configure additional Wi-Fi settings. From the **Wi-Fi** screen, touch  > **Advanced** to view the advanced settings.

Use the **Advanced** settings to configure additional Wi-Fi settings. Press  > **Advanced** to view the advanced settings.

- **General**

- **Network notification** - When enabled, notifies the user when an open network is available.
- **Keep Wi-Fi on during sleep** - Opens a menu to set whether and when the Wi-Fi radio turns off.
 - + **Always On** - The radio stays on when the device enters suspend mode.
 - + **Only when plugged in** - The radio stays on while the device is connected to external power.
 - + **Never On** - The radio turns off when the device enters suspend mode (default).
- **MAC address** - Displays the Media Access Control (MAC) address of the device when connecting to Wi-Fi networks.

- **Regulatory**

- **Country selection** - Displays the acquired country code if 802.11d is enabled else it displays the currently selected country code.
- **Region code** - Displays the current region code.

- **Band and Channel Selection**





- **Wi-Fi frequency band** - Use to select the frequency band. Options: **Auto** (default), **5 GHz only** or **2.4 GHz only**.

- **Available channels (2.4 GHz)** - Use to select specific channels. Touch to display the **Available channels** menu. Select specific channels. Touch **OK**.
- **Available channels (5 GHz)** - Use to select specific channels. Touch to display the **Available channels** menu. Select specific channels. Touch **OK**.
- **Logging**
 - **Advanced Logging** - Provides support for continuous capture of system logs to a file to help in debugging and resolution of Wi-Fi related issues. Disabled by default. In the **Advanced Logging** dialog box, select **Enable Logging**. If desired, change the log directory location. When enabled, the following log are captured:
 -  **Note:**
The MC32N0 must have a microSD card installed.
 - All log files are saved in `/storage/sdcard0/fusionlogs` on the MC32N0.
 - Fusion will ask the user whether he wants to clear out previous logs before starting logging.
 - `tcpdump` capture file and `fusion-sysinfo.log` will only be generated when advanced logging is stopped.
 - + Android logcat output with time stamps and the kernel messages in the file: `fusion-wlan.log`.
 - + `tcpdump` intermediate capture of packets between network stack and driver in the file: `fusion-pktcap.pcap`
 - + Fusion versions, Wi-Fi state machine logs and other framework information in the file: `fusion-sysinfo.log`.
- **About**
 - **Version** - Displays the current Fusion information.

Remove a Wi-Fi Network

To remove a remembered or connected network:

Procedure:

- 1 Touch .
- 2 Touch .
- 3 Touch  **Wi-Fi**.
- 4 In the **Wi-Fi networks** list, touch and hold the name of the network.
- 5 In the menu, touch **Forget network**.
- 6 Press .

Bluetooth

Bluetooth-equipped devices can communicate without wires, using frequency-hopping spread spectrum (FHSS) radio frequency (RF) to transmit and receive data in the 2.4 GHz Industry Scientific and Medical (ISM) band (802.15.1). Bluetooth wireless technology is specifically designed for short-range (10 meters (32.8 feet)) communication and low power consumption.

Devices with Bluetooth capabilities can exchange information (e.g., files, appointments, and tasks) with other Bluetooth enabled devices such as printers, access points, and other mobile devices.

Adaptive Frequency Hopping

Adaptive Frequency Hopping (AFH) is a method of avoiding fixed frequency interferers, and can be used with Bluetooth voice. All devices in the piconet (Bluetooth network) must be AFH-capable in order for AFH to work. There is no AFH when connecting and discovering devices. Avoid making Bluetooth connections and discoveries during critical 802.11b communications. AFH for Bluetooth consists of four main sections:

- Channel Classification - A method of detecting an interference on a channel-by-channel basis, or pre-defined channel mask.
- Link Management - Coordinates and distributes the AFH information to the rest of the Bluetooth network.
- Hop Sequence Modification - Avoids interference by selectively reducing the number of hopping channels.
- Channel Maintenance - A method for periodically re-evaluating the channels.

When AFH is enabled, the Bluetooth radio “hops around” (instead of through) the 802.11b high-rate channels. AFH coexistence allows Enterprise devices to operate in any infrastructure.

The Bluetooth radio in this device operates as a Class 2 device power class. The maximum output power is 2.5 mW and the expected range is 10 meters (32.8 ft.). A definition of ranges based on power class is difficult to obtain due to power and device differences, and whether one measures open space or closed office space.



Note: It is not recommended to perform Bluetooth wireless technology inquiry when high rate 802.11b operation is required.

Security

The current Bluetooth specification defines security at the link level. Application-level security is not specified. This allows application developers to define security mechanisms tailored to their specific need. Link-level security occurs between devices, not users, while application-level security can be implemented on a per-user basis. The Bluetooth specification defines security algorithms and procedures required to authenticate devices, and if needed, encrypt the data flowing on the link between the devices. Device authentication is a mandatory feature of Bluetooth while link encryption is optional.

Pairing of Bluetooth devices is accomplished by creating an initialization key used to authenticate the devices and create a link key for them. Entering a common personal identification number (PIN) in the devices being paired generates the initialization key. The PIN is never sent over the air. By default, the Bluetooth stack responds with no key when a key is requested (it is up to user to respond to the key request event). Authentication of Bluetooth devices is based-upon a challenge-response transaction. Bluetooth allows for a PIN or passkey used to create other 128-bit keys used for security and encryption. The encryption key is derived from the link key used to authenticate the pairing devices. Also worthy of note is the limited range and fast frequency hopping of the Bluetooth radios that makes long-distance eavesdropping difficult.

Recommendations are:

- Perform pairing in a secure environment
- Keep PIN codes private and do not store the PIN codes in the device
- Implement application-level security.

Bluetooth Profiles

The MC32N0 with Android supports the following Bluetooth services:

- Generic Access Profile (GAP) - Use for device discovery and authentication.
- Service Discovery Access Protocol (SDP) - Handles the search for known and specific services as well as general services.
- Serial Port Profile (SPP) - Sets up a virtual serial port and connects two Bluetooth enabled devices. For example, connecting the MC32N0 to a printer.
- Human Interface Device Profile (HID) - Allows Bluetooth keyboards, pointing devices, gaming devices and remote monitoring devices to connect to the MC32N0.

- Dial-up Networking (DUN) - Allows the MC32N0 to access the Internet and other dial-up services using a Bluetooth enabled mobile phone.
- Personal Area Network (PAN) - Allow the use of Bluetooth Network Encapsulation Protocol on Layer 3 protocols for transport over a Bluetooth link.
- General Object Exchange Profile (GOEP) - Provides a basis for other data profiles. Based on OBEX and sometimes referred to as such.
- Headset Profile (HSP) - Allows a hands-free device, such as a Bluetooth headset, to place and receive calls on the MC32N0.

Bluetooth Power States

The Bluetooth radio is off by default.

- **Suspend** - When the MC32N0 goes into suspend mode, the Bluetooth radio stays on.
- **Airplane Mode** - When the MC32N0 is placed in Airplane Mode, the Bluetooth radio turns off. When Airplane mode is disabled, the Bluetooth radio returns to the prior state. When in Airplane Mode, the Bluetooth radio can be turned back on if desired.

Bluetooth Radio Power – Android

Turn off the Bluetooth radio to save power or if entering an area with radio restrictions (e.g., an airplane). When the radio is off, other Bluetooth devices cannot see or connect to the device. Turn on the Bluetooth radio to exchange information with other Bluetooth devices (within range). Communicate only with Bluetooth radios in close proximity.



Note: To achieve the best battery life turn off radios when not in use.

Enabling Bluetooth

Procedure:

- 1 Touch
- 2 Touch
- 3 Slide the Bluetooth switch to the **ON** position. also appears in the Status bar.
- 4 Press

Disabling Bluetooth

Procedure:

- 1 Touch
- 2 Touch
- 3 Slide the Bluetooth switch to the **OFF** position.
- 4 Press

Discovering Bluetooth Device(s)

The MC32N0 can receive information from discovered devices without pairing. However, once paired, the MC32N0 and a paired device exchange information automatically when the Bluetooth radio is on. To find Bluetooth devices in the area:

Procedure:



- 1 Ensure that Bluetooth is enabled on both devices.
- 2 Ensure that the Bluetooth device to discover is in discoverable mode.
- 3 Ensure that the two devices are within 10 meters (32.8 feet) of one another.
- 4 Touch .
- 5 Touch .
- 6 Touch  **Bluetooth**.
- 7 Touch **SCAN FOR DEVICES**. The MC32N0 begins searching for discoverable Bluetooth devices in the area and displays them under **AVAILABLE DEVICES**.
- 8 Scroll through the list and select a device. The **Bluetooth pairing request** dialog box appears.

Figure 69: Bluetooth Pairing - Enter PIN

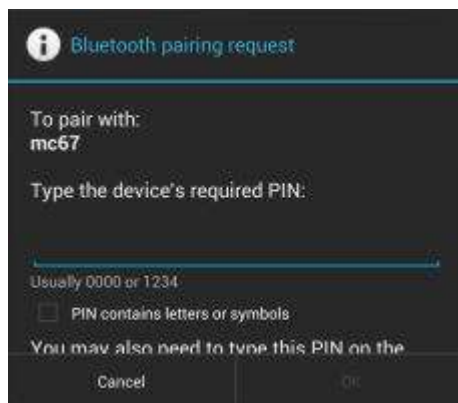
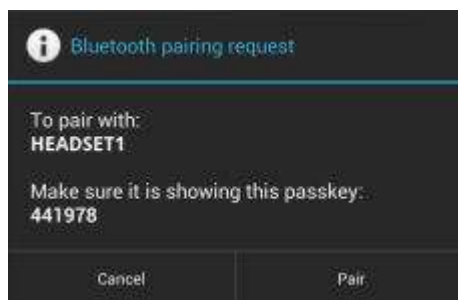

Figure 70: Bluetooth Pairing - Smart Pairing







- 9 Enter a PIN in the text box and touch **OK**. Enter the same PIN on the other device.
- 10 For Simple Pairing, touch **Pair** on both devices.
- 11 The Bluetooth device is added to the **Bluetooth devices** list and a trusted (“paired”) connection is established.

Changing the Bluetooth Name

By default, the MC32N0 has a generic Bluetooth name that is visible to other devices when connected.



Procedure:

- 1 Touch .
- 2 Touch  **Bluetooth**.
- 3 If Bluetooth is not on, slide the switch to the **ON** position.
- 4 Touch .
- 5 Touch **Rename device**.
- 6 In the **Rename device** dialog box, enter a name and touch **Rename**.
- 7 Touch .

Connecting to a Bluetooth Device

Once paired, connect to a Bluetooth device.





Procedure:

- 1 Touch .
- 2 Touch .
- 3 Touch  **Bluetooth**.
- 4 If Bluetooth is not on, slide the switch to the **ON** position.
- 5 In the **PAIRED DEVICES** list, touch and hold on a unconnected Bluetooth device until a menu appears.
- 6 Touch **Connect**. When connected, the device is displayed as connected in the list.

Selecting Profiles on the Bluetooth Device

Some Bluetooth devices have multiple profiles. To select a profile:

Procedure:

- 1 Touch .
- 2 Touch .
- 3 Touch  **Bluetooth**.
- 4 In the **PAIRED DEVICES** list, touch  next to the device name.
- 5 Under **PROFILES**, check or uncheck a profile to allow the device to use that profile.
- 6 Press .

Unpairing a Bluetooth Device

To unpair a Bluetooth device and erase all pairing information:

Procedure:

- 1 Touch .
- 2 Touch .

- 3 Touch  **Bluetooth**.
- 4 In the **PAIRED DEVICES** list, touch  next to the device name.
- 5 Touch **Unpair**.
- 6 Press .

Chapter 3

Using the MC32N0 with Windows CE

This chapter describes the screens, status and notification icons, and controls on the MC32N0, and provides basic instructions for using the MC32N0.

Sample Applications Window

The MC32N0 with Windows CE contains a set of sample applications that can be installed. By default an installation icon is on the Desktop. Double-tap the icon to install the sample applications. When installed, the Sample Applications window appears on the screen whenever the MC32N0 re-boots. Refer to the *MC32N0 Integrator Guide* for installation and configuration.

The Sample Applications window links to sample applications. The sample applications are intended to be used by application developers as application development examples. These applications were not developed to support end users. Refer to the *Application Guide for Zebra Devices* for the sample applications.

Figure 71: Sample Applications Window

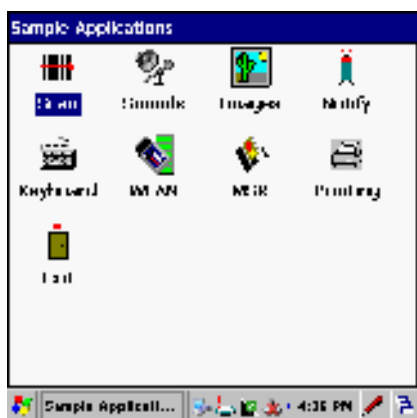

Desktop

The desktop screen displays when the MC32N0 turns on. Depending upon the configuration, the Home screen might appear different. Contact your system administrator for more information.

Figure 72: Desktop

Taskbar

The Taskbar at the bottom of the window displays the active programs, current time, battery status and communication status.

Figure 73: Notification and Status Icons**Table 14: Windows CE Taskbar**















Item	Description
1	Start Button
2	Open Programs
3	Status Icons
4	Input Panel Button
5	Desktop Button

Status Icons

Table 15: Status Icons

Icon	Description
	Clock: Indicates the current time.
	Battery: This icon indicates that the main battery is charging or that the terminal is operating on AC power. Double tapping on this icon opens the Power Properties window.
	AC Plug: Indicates that the battery is fully charged and the MC32N0 is running on external power.

Table continued...

Icon	Description
	Battery: This icon indicates that the battery is fully charged (100% charged). The battery status icons provide the battery status in 10% increments from 10% to 100%.
	Serial Connection: It is displayed when the terminal is connected to a host computer with a serial cable.
	Wireless Connection Status: Indicates WLAN signal strength.
	Bluetooth Enabled: Indicates that the Bluetooth radio is on.
	Bluetooth Disabled: Indicates that the Bluetooth radio is off (BTEplorer only).
	Bluetooth Communication: Indicates that the MC32N0 is communicating with another Bluetooth device (BTEplorer only).
	DataWedge Running: Indicates that the DataWedge application is running.
	DataWedge Idle: Indicates that the DataWedge application is idle.
	Shift: Indicates that the SHIFT key function is selected.
	Shift-Lock: Indicates that the SHIFT key is selected and locked.
	FUNC: Indicates that the FUNC button function is selected.
	CTRL: Indicates that the CTRL button function is selected.
	ALT: Indicates that the ALT character selection is selected.
	ALPHA: Indicates that the MC32N0 is in ALPHA button mode is selected.

Control Panel

The table below lists the applications in the Control Panel.

Table 16: Applications in the Programs Menu





Icon	Description
	Backlight: Adjust the backlight brightness and power settings.
	Bluetooth Device Properties: Launch the StoneStreet One application when enabled..
	Certificates: See information about certificates installed on the MC32N0.
	DataWedge: Sample scanning application. Icon appears after installation.
	Date/Time: Change date, time and time zone information.

Table continued...





















Icon	Description
	Dialing: Set dialing properties for modem communication and change telephony settings.
	Display: Change desktop background, appearance, backlight and brightness.
	Error Reporting: Choose whether the MC32N0 collects software operation information to use if a serious error occurs.
	Input Panel: Switch input methods and set input options.
	Internet Options: Control how the MC32N0 connects to the internet.
	IST Settings: Set the appropriate settings for configuring the MC32N0's Interactive Sensor Technology.
	Keyboard: Change keyboard repeat delay and rate.
	MotoBTUI: Opens the MotoBTUI application when Microsoft Bluetooth stack is enabled.
	Mouse: Adjust double-click sensitivity for both the speed and timing.
	Network and Dial-up Connections: Connect to other computers, networks and the Internet using a modem.
	Owner: Change owner's personal profiles.
	Password: Set a password for the MC32N0.
	PC Connection: Change settings for connectivity of a host computer.
	Power: View and control MC32N0 power settings.
	Regional Settings: Change how numbers, currencies, dates and times appear.
	Remove Programs: Remove programs installed on the MC32N0.
	Stylus: Calibrate the touch screen and adjust double-tap timing.
	System: View system information and change memory settings.
	System Info: View information on the MC32N0's system components.

Table continued...

Icon	Description
	USBConfig: Configure the MC32N0 USB port.
	Volume & Sounds: Select the type of actions for which to hear sounds and customize notifications for different events.

Start Menu

To open the Start menu, tap  at the bottom left corner of the screen. The table below lists the default applications available in the Programs menu.

Table 17: Applications in the Programs Menu



















Icon	Description
	Fusion Folder: Open the Wireless Companion folder.
	Debug Folder: Open the Debug folder that contains eMscript installation file. Once installed, contains Start eMscript and Stop eMscript applications.
	BatteryHealthManagementApp: Installs the BatteryHealthManagementApp application on the MC32N0. Note: Perform a cold boot after installation.
	BattSwap: Use to properly shutdown the MC32N0 during battery replacement.
	BTScanner CtlPanel: Set com port to use with a Bluetooth scanner.
	Command Prompt: Opens a DOS command prompt window.
	CtlPanel: View and change MC32N0 settings such as: Scanner Parameters, Display Settings, Audio Settings, Printer Settings, Date and Time Settings, Touch Screen Settings, etc.
	DataWedgeDemo - Sample scanning application. Icon appears after installation.
	Internet Explorer: Browse Web and WAP sites as well as download new programs and files from the Internet.
	Media Player: Play back audio files.
	Microsoft WordPad: Create documents.
	Mobi Control Agent: Opens the SOTI MobiScan Agent application after installation.
	MotoBTUI: Pairs bar code with the MC32N0 via Bluetooth and uses the RS507 Hands-free Imager to capture the bar code data.

Table continued...

Icon	Description
	MSP Agent: Interacts with MSP agents to collect monitoring and asset information to enable the configuration, provisioning, monitoring and troubleshooting of the MC32N0. Refer to the MC32N0 Integrator Guide for more information.
	PTT Express Configuration - Initially installs the PTT Express Configuration application on the MC32N0. Opens the PTT Express Configuration application after installation.
	Rapid Deployment Client: Facilitates software downloads from a Mobility Services Platform Console FTP server to the MC32N0. Refer to the <i>Mobility Services Platform</i> documentation for more information.
	Remote Desktop Connection: Log onto Windows NT server type computers and use all of the programs that are available on that computer from the MC32N0.
	Samples - Opens the Sample Applications window, when installed.
	SOTI MobiScan Agent: Installs the Mobi Control Agent application on the MC32N0.
	TelnetCE: Opens the Wavelink Telnet client.
	WarmBoot: Warm boots the MC32N0.
	Windows Explorer: Organize and manage files on your device.

DataWedge Demo

Use **DataWedge Demo** to demonstrate data capture functionality.

Figure 74: DataWedge Demo Window



Press the scanner button to capture the bar code data. The bar code contents appears in the text box.

PTT Express Configuration



Note:

PTT Express Configuration creates Push-To-Talk (PTT) communication capability between disparate enterprise devices. Leveraging existing Wireless Local Area Network (WLAN) infrastructure, PTT Express delivers simple PTT communication without the need of a voice communication server.

- **Group Call:** Press and hold the Group Call button (green button) to start communicating with other voice client users.
- **Private Response:** Press and hold the Private Response button (red button) to respond to the originator of the last broadcast or to make a Private Response.

Figure 75: PTT Button Assignment

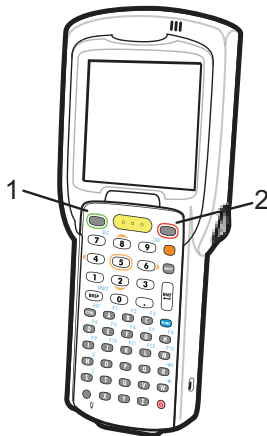

1	Green Button – Group Call button
2	Red Button – Private Response button

PTT Audible Indicators

The following tones provide helpful cues when using the voice client.

- **Talk Tone:** Double chirp. Plays when the Group Call or Private Response button is depressed. This is a prompt for the user to start talking.
- **Access Tone:** Single beep. Plays when another user just finished a broadcast or response. The user is now able to initiate a Group Call or Private Response.
- **Busy Tone:** Continuous tone. Plays when the Group Call or Private Response button is depressed and another user is already communicating on the same talkgroup. Plays after the maximum allowed talk time is reached (60 seconds).
- **Network Tone:**
 - Three increasing pitch beeps. Plays when PTT Express has acquired the WLAN connection and the service is enabled.
 - Three decreasing pitch beeps. Plays when PTT Express has lost the WLAN connection or the service is disabled.

Figure 76: PTT Express Window

Select the **Voice Client Enabled** checkbox to enable PTT Express.

In the drop-down menu, select a talkgroup.

Creating a Group Call

Procedure:

- 1 Press and hold the Group Call button and listen for the talk tone to play.
If a busy tone is heard, release the button and wait a moment before making another attempt. Ensure that PTT Express and the WLAN are enabled.
- 2 Start talking after the talk tone is heard.



Note: If the user holds the button for more than 60 seconds (default), the call is dropped allowing others to make Group calls. The user should release the button when finished talking to allow others to make calls.

- 3 Release the button when finished talking.

Responding with a Private Response

The Private Response can only be initiated once a Group Call has been established. The initial Private Response is made to the originator of the Group Call.

Procedure:

- 1 Wait until an access tone is heard.
- 2 Press and release and then press and hold the Talk button and listen for the talk tone to play.
If a busy tone is heard, release the button and wait a moment before making another attempt. Ensure that PTT Express and the WLAN are enabled.
- 3 Start talking after the talk tone plays.
- 4 Release the button when finished talking.

Battery Health Management

After installation, the Battery Health icon appears in the Task Tray.

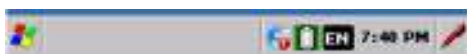
Figure 77: Task Tray Icon

Touch the icon to view the **Battery Health** dialog box.

Figure 78: Battery Health Dialog Box

- **Battery Power** - Indicates the current battery power, represented as a percentage of the total battery capacity.
- **Battery Health** - Indicates the battery health using a five star-rating system based on a predefined battery usage count threshold value. If the battery falls below any of these values, it is assigned to a lower star-rating.
- **Cycle Count** - Displays the current battery usage count of the battery (configurable).

The background color also indicates the battery health.

Figure 79: Battery Background Color

- Green - Indicates that the battery is healthy.
- Yellow - Indicates that the battery is reaching the end of its useful life.
- Red - Indicates that the battery should be replaced.

The inside of the battery indicates the battery level. The white area indicates the charge level.

After a pre-defined time period, the dialog box disappears.

The Battery health dialog box can be set to appear after the device resumes from suspend mode or depending upon the health status.

Battery Health

The health of the battery can be viewed on the MC32N0 Power applet.

Tap **Start > Settings > Control Panel > Power icon > BatteryMgmt** tab.

For information on changing the Battery Usage Threshold, refer to the *MC32N0 Integrator Guide*.

Figure 80: Battery Health Window**Table 18: BatteryMgmt Window**

Item	Description
State of Health	Indicates the current state of the battery (Healthy or Unhealthy).
Battery Usage Indicator	Indicates the usage of the battery.
Battery Usage Threshold	Indicates the usage indicator threshold.
Battery Serial #	Displays the serial number of the battery.

Entering Information

To enter information:

- Use the keypad.
- Use the keyboard input panel (soft keyboard) to enter text.
- Scan bar code data into data fields.
- Use Microsoft® ActiveSync® to synchronize or copy information from the host computer to the mobile computer. For more information on ActiveSync, refer to the *MC32N0 Integrator Guide*.

The Sample Applications window links to sample applications. The sample applications are intended to be used by application developers as application development examples. These applications were not developed to support end users. Refer to the Application Guide for Zebra Devices for the sample applications.

Entering Information Using Keypad

The 28, 38 and 48-key alphanumeric keypads produce the 26-character alphabet (A - Z), numbers (0 - 9), function keys and assorted characters. The keypads default characters/functions are printed black or white, the ALPHA character/functions are printed orange and the FUNC character/functions are printed blue. See [MC32N0 Keypads on page 161](#) for keypad configurations, keypad special functions and special character generation.

Entering Information Using the Input Panel

Use the input panel (soft keyboard) to enter information in any program. There are two input panels available. To launch the input panel, touch the input panel button on the taskbar and select **Keyboard** or **XAMLIM**. Touch a key to enter the value. Touch the input panel button to display or to hide the input panel.

Figure 81: Keyboard Input Panel**Figure 82: XAMLIM Input Panel**

Entering Data via the Bar Code Scanner

The sample bar code scanner application scans data into data fields in the same way data is entered via the keypad.

Calibration Screen



Note: Available on devices with Rev B software.

Use the Calibration screen to align the touch screen:

Procedure:

- 1 Remove the stylus from the stylus holder.
- 2 Touch **Start > Settings > Control Panel > Stylus > Calibration** tab.
- 3 Touch **Recalibrate**.
- 4 Carefully press and briefly hold the stylus tip on the center of the Calibration screen target. Repeat the procedure as the target moves and stops at different locations on the screen. This enters the new calibration settings.

Figure 83: Calibration Screen

- 5 Once all of the new calibration settings are input, tap the screen or press the ENTER button to save the new calibration settings. Press ESC to discard the new calibration settings.

Interactive Sensor Technology

This section describes the functionality of the Interactive Sensor Technology (IST) feature on the MC32N0. Refer to the *MC32N0 Integrator Guide* for configuring IST.

The IST supports the following features.

- Power Management – manage power by configuring IST to control switching on/off the backlight, control suspend mode of the MC32N0 by monitoring motion and orientation.
- Display Orientation – switch the screen orientation to either landscape or portrait depending on the MC32N0 orientation.
- Free Fall Detection – monitors free fall duration and records the time and type of the drop event.

Power Management

The MC32N0 orientation and motion sensitive data can be used as an indicator of MC32N0 usage and can be used to manage the battery power of the mobile computer. For example, IST can be configured to control the backlight on and off functionality or go into suspend according to a user gesture by placing screen facing down. It can also be used to keep the MC32N0 active while it is in movement to prevent it from quickly going into suspend mode while in use.

Display Orientation

The screen can be rotated between portrait and landscape modes automatically, depending on the physical orientation of the MC32N0. For example, if the MC32N0 is rotated 90° counterclockwise, IST rotates the display counterclockwise 90° so that the screen display appears correct.

This functionality is achieved by monitoring screen angle and rotating the display to counter any changes. IST only rotates the screen in multiples of 90°.

Figure 84: Display Orientation

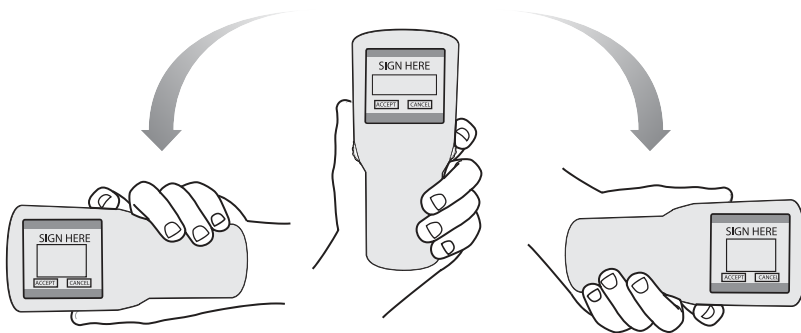

Free Fall Detection

IST continuously monitors gravitational force on the MC32N0 according to its current position. When the MC32N0 free falls, IST detects the absence of gravitational force and records the event data if it detects a free fall more than 450 ms, which may indicate nearly a one meter drop. This data can be used as an indicator of potential abuse or misuse.

IST features a log for recording the free fall events. This log records the date, time and the time period of the free fall.

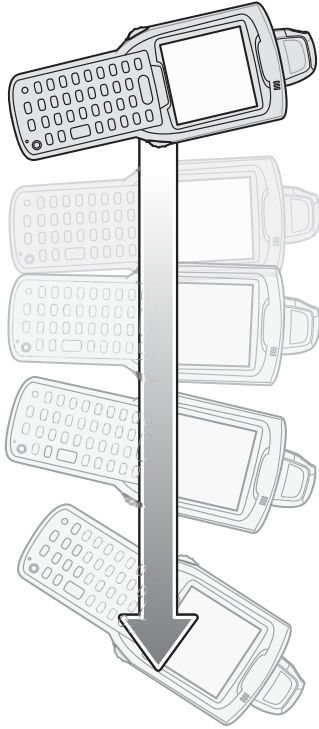
Figure 85: Free Fall Detection

Resetting the MC32N0

If the MC32N0 stops responding to input, reset it. There are two reset functions, warm boot and cold boot. A warm boot restarts the MC32N0 by closing all running programs. All data that is not saved is lost.

A cold boot also restarts the MC32N0, but erases all stored records and entries from RAM. In addition it returns formats, preferences and other settings to the factory default settings.

Perform a warm boot first. If the MC32N0 still does not respond, perform a cold boot.

Performing a Warm Boot



Caution: Files that remain open during a warm boot may not be retained.

Procedure:

- 1 Press the Power button for five seconds.
- 2 As soon as the MC32N0 starts to perform a warm boot release the Power button.

Performing a Cold Boot

A cold boot restarts the MC32N0 and erases all user stored records and entries from RAM. Never perform a cold boot unless a warm boot does not solve the problem.



Caution: Cold boot resets the MC32N0, to the default settings. All added applications and all stored data are removed. Do not cold boot without support desk approval.

Procedure:

- 1 Simultaneously press and then release the 1, 9 and Power keys. Do not hold down any other keys or buttons. As the MC32N0 initializes, the splash window appears for about a minute.
- 2 Calibrate the touch screen.

WLAN

Wireless Local Area Networks (LANs) allow mobile computers to communicate wirelessly and send captured data to a host device in real time. Before using the MC32N0 on a WLAN, the facility must be set up with the required hardware to run the wireless LAN and the MC32N0 must be configured. Refer to the documentation provided with the access points (APs) for instructions on setting up the hardware.



Note: 802.11d is enabled by default. When enabled, the AP must be configured the same in order to connect.

To configure the MC32N0, a set of wireless applications provide the tools to configure and test the wireless radio in the MC32N0. Refer to the *Wireless Fusion Enterprise Mobility Suite User Guide for Version X2.01* for information on configuring wireless profiles. Go to <http://www.zebra.com/support> for the latest version of this guide. See Software Versions on page xii to determine the Fusion version on the MC32N0.



Note: Select the Country for the MC32N0's country of operation. The access point prompts for the correct country code on the first login. A warning message also displays stating an incorrect country setting may result in illegal radio operation. Selecting the correct country is central to legally operating the access point. Each country has its own regulatory restrictions concerning electromagnetic emissions and the maximum RF signal that can be transmitted. To ensure compliance with national and local laws, set the country accurately. MC32N0 users cannot configure their access point until country code is set.

Tap the **Signal Strength** icon to display the **Wireless Launcher** menu.

Figure 86: Wireless Applications Menu



Many of the items in the menu invoke one of the Fusion applications. These menu items and their corresponding applications are summarized below:

- **Find WLANs** – Invokes the Find WLANs application which displays a list of the WLANs active in your area. The **Wireless Application** menu on the task tray provides the following wireless applications:
- **Manage Profiles** – Invokes the Manage Profiles application (which includes the Profile Editor Wizard) to manage and edit your list of WLAN profiles.

- **Manage Certs** – Invokes the Certificate Manager application which allows you to manage certificates used for authentication.
- **Manage PACs** – Invokes the PAC Manager application which helps you manage the list of Protected Access Credentials used with EAP-FAST authentication.
- **Options** – Invokes the Options application which allows you to configure the Fusion option settings.
- **Wireless Status** – Invokes the Wireless Status application which allows you to view the status of the current wireless connection.
- **Wireless Diagnostics** – Invokes the Wireless Diagnostics application which provides tools with which to diagnose problems with the wireless connection.
- **Log On/Off** – Invokes the Network Login dialog which allows you to log on to a particular profile or to log off from the currently active profile.







Additional Wireless Launcher menu entries include:

- **Enable/Disable Radio**
- **Hide Menu**
- **Exit**

Signal Strength Icon

The Signal Strength icon in the task tray indicates the mobile computer’s wireless signal strength as follows:

Table 19: Signal Strength Icons Descriptions

Icon	Status	Description
	Excellent signal strength	Wireless LAN network is ready to use.
	Very good signal strength	Wireless LAN network is ready to use.
	Good signal strength	Wireless LAN network is ready to use.
	Fair signal strength	Wireless LAN network is ready to use. Notify the network administrator that the signal strength is only “Fair”.
	Poor signal strength	WLAN network is ready to use. Performance may not be optimum. Notify the network administrator that the signal strength is “Poor”.
	Out-of-network range (not associated)	No WLAN network connection. Notify the network administrator.
	The WLAN radio is disabled.	WLAN radio is disabled. To enable, choose Enable Radio from the Wireless Applications menu.
None	The Wireless Launcher application was exited.	The Wireless Launcher application has been closed. See the Fusion Functions paragraphs below for how to restart the Wireless Launcher .

Fusion Setup

For detailed WLAN setup using Fusion, refer to the Wireless Fusion Enterprise Mobility Suite User Guide for Version X2.01.

**Note:**

Obtain the proper WLAN configuration information from the system administrator prior to performing the Fusion setup procedures.

The following setup procedure example shows setup of a WLAN using Wired Equivalent Privacy (WEP) encryption.

Procedure:

- 1 Touch Fusion icon > **Manage Profiles**.
- 2 Touch and hold in the window and select **Add** from the pop-up menu.
- 3 In the **Profile Name** text box enter a name for the profile.
- 4 In the **ESSID** text box enter the ESSID.

Figure 87: Profile ID Dialog Box

- 5 Touch **Next**.
- 6 In the **Operating Mode** drop-down list, select **Infrastructure** or **Ad-hoc**.

Figure 88: Operating Mode Dialog Box

- 7 Touch **Next**.
- 8 In the **Security Mode** drop-down list, select **Legacy (Pre-WPA)**.

Figure 89: Security/Authentication Dialog Box

- 9 In the **Authentication** drop-down list, select **None**.
- 10 Touch **Next**.
- 11 In the **Encryption Type** drop-down list, select **WEP-40 (40/24)**.

Figure 90: Encryption Dialog Box

- 12 Select the **Pass-phrase** or **Hexadecimal Keys** radio button to indicate whether a pass-phrase or hexadecimal keys will be entered on the next page.
- 13 Select the **For added security - Mask characters entered** check box to hide characters entered. Deselect this to show characters entered.
- 14 Touch **Next**.

Figure 91: WEP-40 WEP Keys Dialog Box

- 15 In the **Edit Key** drop-down list, select the key to enter.
- 16 In the **Key** field, enter 10 hexadecimal characters.
- 17 In the **Confirm** field, re-enter the key. When the keys match, a message appears indicating that the keys match.
- 18 Repeat for each WEP key.
- 19 In the **Transmit Key** drop-down list, select the key to transmit.
- 20 Touch **Next**.

Figure 92: IP Address Entry Dialog Box

- 21 Ensure that all three check boxes are selected.
- 22 Touch **Next**.
- 23 In the **Battery Usage Mode** dialog box select a power consumption option.

Figure 93: Battery Usage Dialog Box

24 Touch **Next**.

25 In the **Performance Settings** dialog box select either **Optimize for Data** or **Optimize for Voice**.

26 Touch **Save**.

Using Bluetooth with Windows CE

Adaptive Frequency Hopping

Adaptive Frequency Hopping (AFH) is a method of avoiding fixed frequency interferers, and can be used with Bluetooth voice. All devices in the piconet (Bluetooth network) must be AFH-capable in order for AFH to work. There is no AFH when connecting and discovering devices. Avoid making Bluetooth connections and discoveries during critical 802.11b communications. AFH for Bluetooth consists of four main sections:

- Channel Classification - A method of detecting an interference on a channel-by-channel basis, or pre-defined channel mask.
- Link Management - Coordinates and distributes the AFH information to the rest of the Bluetooth network.
- Hop Sequence Modification - Avoids interference by selectively reducing the number of hopping channels.
- Channel Maintenance - A method for periodically re-evaluating the channels.

When AFH is enabled, the Bluetooth radio “hops around” (instead of through) the 802.11b high-rate channels. AFH coexistence allows Enterprise devices to operate in any infrastructure.

The Bluetooth radio in this device operates as a Class 2 device power class. The maximum output power is 2.5 mW and the expected range is 10 meters (32.8 ft.). A definition of ranges based on power class is difficult to obtain due to power and device differences, and whether one measures open space or closed office space.



Note: It is not recommended to perform Bluetooth wireless technology inquiry when high rate 802.11b operation is required.

Security

The current Bluetooth specification defines security at the link level. Application-level security is not specified. This allows application developers to define security mechanisms tailored to their specific need. Link-level security occurs between devices, not users, while application-level security can be implemented on a per-user basis. The Bluetooth specification defines security algorithms and procedures required to authenticate devices, and if needed, encrypt the data flowing on the link between the devices. Device authentication is a mandatory feature of Bluetooth while link encryption is optional.

Pairing of Bluetooth devices is accomplished by creating an initialization key used to authenticate the devices and create a link key for them. Entering a common personal identification number (PIN) in the devices being paired generates the initialization key. The PIN is never sent over the air. By default, the Bluetooth stack responds with no key when a key is requested (it is up to user to respond to the key request event). Authentication of Bluetooth devices is based-upon a challenge-response transaction. Bluetooth allows for a PIN or passkey used to create other 128-bit keys used for security and encryption. The encryption key is derived from the link key used to authenticate the pairing

devices. Also worthy of note is the limited range and fast frequency hopping of the Bluetooth radios that makes long-distance eavesdropping difficult.

Recommendations are:

- Perform pairing in a secure environment
- Keep PIN codes private and do not store the PIN codes in the device
- Implement application-level security.

Bluetooth Profiles

The MC32N0 with WinCE7 supports the following Bluetooth services:

- Microsoft stack:
 - Generic Access Profile (GAP) - Use for device discovery and authentication.
 - Service Discovery Access Protocol (SDP) - Handles the search for known and specific services as well as general services.
 - Serial Port Profile (SPP) - Sets up a virtual serial port and connects two Bluetooth enabled devices. For example, connecting the MC32N0 to a printer.
 - Headset Profile (HSP) - Allows a hands-free device, such as a Bluetooth headset, to place and receive calls on the MC32N0.
- StoneStreet stack:



Note: Devices with Rev B software, support WideBand Audio (WBA) with the StoneStreet stack. WBA is automatically enabled when pairing a WBA enabled 3rd-party headset with the device.

- Generic Access Profile (GAP) - Use for device discovery and authentication.
- Service Discovery Access Protocol (SDP) - Handles the search for known and specific services as well as general services.
- Serial Port Profile (SPP) - Sets up a virtual serial port and connects two Bluetooth enabled devices. For example, connecting the MC32N0 to a printer.
- Human Interface Device Profile (HID) - Allows Bluetooth keyboards, pointing devices, gaming devices and remote monitoring devices to connect to the MC32N0.
- Dial-up Networking (DUN) - Allows the MC32N0 to access the Internet and other dial-up services using a Bluetooth enabled mobile phone.
- Personal Area Network (PAN) - Allow the use of Bluetooth Network Encapsulation Protocol on Layer 3 protocols for transport over a Bluetooth link.
- General Object Exchange Profile (GOEP) - Provides a basis for other data profiles. Based on OBEX and sometimes referred to as such.
- Headset Profile (HSP) - Allows a hands-free device, such as a Bluetooth headset, to place and receive calls on the MC32N0.
- Handsfree Profile (HFP) - Allows car hands-free kits to communicate with the MC32N0 in a car.

MotoBTUI Application

Use the MotoBTUI application to:

- Turn the Bluetooth radio on and off
- View device information
- Control device status
- Generate a pairing bar code
- Configure FIPS key
- Discover and pair with other Bluetooth devices (using the Microsoft stack).

Figure 94: MotoBTUI Window

Viewing Device Information

Procedure:

- 1 Touch **Start > Programs > MotoBTUI**.
- 2 Touch **My Device information**.

The **Device Information** displays:

- Device Name
- HCI version number
- LMP version number
- Bluetooth chip manufacturer name
- BT UI version number.

Figure 95: MotoBTUI Window

- 3 Touch the Back button to return to the **MotoBTUI** window.

FIPS Configuration



Note: By default the MC32N0 has a Federal Information Processing Standards (FIPS) key installed. If required, the user can generate a new FIPS key. If a new key is generated on the MC32N0, the same key is required to be used on the other Bluetooth device. The user must transfer the key to the other device.

Generating a New FIPS Key Automatically

Procedure:

- 1 Touch **Start > Programs > MotoBTUI**.

2 Touch **FIPS Configuration**.

Figure 96: AES Key Window



3 Touch **Generate Key**.

4 Touch the **SetUp Key** button. A new key is generated. The key file, `NewAESKey.reg`, is created in the `/Application` folder.

5 Touch the Back button to return to the **MotoBTUI** window.

Generating a New FIPS Key Manually

Procedure:

1 Touch **Start > Programs > MotoBTUI**.

2 Touch **FIPS Configuration**.

3 Touch **Enter Key**.

4 In the text box, enter a key.

5 Touch the **SetUp Key** button. A new key is generated. The key file, `NewAESKey.reg`, is created in the `/Application` folder.

6 Touch the Back button to return to the **MotoBTUI** window.

Transferring a New FIPS Key to Another Bluetooth Device

Procedure:

1 Copy the `NewAESKey.reg` file from the MC32N0 to the other Bluetooth device. Place the file into the `/Application` folder..

2 Navigate to the `/Application` folder..

3 Locate the `NewAESKey.reg` file and touch the filename. The **RegMerge** confirmation box displays..

4 Touch **Yes**.

5 Perform a warm boot.

DeviceStatus

Use the **Device Status** option to set if the MC32N0 would be seen by other Bluetooth devices. Touch the **Device Status** option to toggle the MC32N0 from Hidden to Discoverable.

Using Microsoft Bluetooth Stack with Windows CE

The following sections provide information on using the Microsoft Bluetooth stack with Windows CE operating system.

Bluetooth Radio Power – Windows CE

Turn off the Bluetooth radio to save power or if entering an area with radio restrictions (e.g., an airplane). When the radio is off, other Bluetooth devices cannot see or connect to the MC32N0. Turn on the Bluetooth radio to exchange information with other Bluetooth devices (within range). Communicate only with Bluetooth radios in close proximity.



Note: To achieve the best battery life turn off radios when not in use.

Enabling Bluetooth

Procedure:

- 1 Touch **Start** > **Settings** > **Control Panel** > **MotoBTUI**.

Figure 97: Enable Bluetooth



- 2 Touch **Off** tab in the top left corner. The Bluetooth icon appears in the task tray.

Disabling Bluetooth

Procedure:

- 1 Touch **Start** > **Settings** > **Control Panel** > **MotoBTUI**.

Figure 98: Enable Bluetooth



- 2 Touch **On** tab in the top left corner. The Bluetooth icon is removed from the task tray.

Power Modes

The Bluetooth radio switches between normal and low power modes automatically. When data transfer is required, the radio goes into normal mode. After five seconds of inactivity, the radio goes into low power mode.

Discovering Bluetooth Device(s)

The MC32N0 can receive information from discovered devices without bonding. However, once bonded, the MC32N0 and a bonded device exchange information automatically when you turn the Bluetooth radio on.

Procedure:

- 1 Ensure that Bluetooth is enabled on both devices.
- 2 Ensure that the Bluetooth device to discover is in discoverable and connectable modes.
- 3 Ensure that the two devices are within 10 meters (32.8 feet) of one another.
- 4 Touch **Start > Settings > Control Panel > MotoBTUI**.
- 5 If Bluetooth is off, select the Bluetooth icon to turn Bluetooth on.
- 6 Select the **Connections** tab. The MC32N0 begins searching for discoverable Bluetooth devices in the area. Discovered devices appear in the list.

Figure 99: Searching for Bluetooth Devices



- 7 Use the navigation key to select a Bluetooth device.
- 8 Press **ENTER**. The **Services** window displays.
- 9 Touch **Pair**.
- 10 On the Bluetooth device, allow pairing.
- 11 On the MC32N0, touch **Yes**.

Figure 100: Allow Pairing



12 The **Pair** button changes to **Unpair**.

13 Touch the back button. The device appears in the **Paired** section on the **Connection** tab.

Figure 101: Device Paired



Using StoneStreet Bluetooth Stack with Windows CE

The following sections provide information on using the StoneStreet Bluetooth stack with Windows CE operating system.

Turning the Bluetooth Radio Mode On and Off

Turn off the Bluetooth radio to save power or if entering an area with radio restrictions (e.g., an airplane). When the radio is off, other Bluetooth devices cannot see or connect to the MC32N0. Turn on the Bluetooth radio to exchange information with other Bluetooth devices (within range). Communicate only with Bluetooth radios in close proximity.



Note: To achieve the best battery life turn off radios not in use.

Modes

The BTEplorer application has two modes for managing Bluetooth connections: Wizard Mode and Explorer Mode. The Wizard Mode is for novice Bluetooth users and the Explorer Mode is for experienced Bluetooth users. To switch between modes, select **View > Wizard Mode** or **View > Explorer Mode**.

Wizard Mode

Wizard Mode provides a simple process for discovering and connecting to Bluetooth devices.



Note: Switching between Wizard Mode and Explorer Mode closes all active connections.

Wizard Mode shows the devices and services in a simple Favorites view created by following the step-by-step wizard.

Explorer Mode

The **Explorer Mode** window is easy to navigate and provides greater control to users familiar with Bluetooth. The menu bar provides quick access to the options and tools used to connect to devices. To access Explorer Mode, tap **View > Explorer Mode**.

Also use the “tap and hold” technique to view available options. Scroll bars and view options are similar to those on the Windows desktop. The tree structure lists the following sub-items:

- Local Device - This device

- Remote Device - Other Bluetooth devices
 - Trusted Devices - Bonded (paired) Bluetooth devices
 - Untrusted Devices - Discovered devices that are not bonded
- Favorites - Selected services that are set as Favorite for quick access.



Note: Switching between Wizard Mode and Explorer Mode closes all active connections.

Discovering Bluetooth Device(s)

The MC32N0 can receive information from discovered devices without pairing. However, once paired, the MC32N0 and a paired device exchange information automatically when you turn the Bluetooth radio on. See [Pairing with Discovered Device\(s\) on page 111](#) for more information.

Procedure:

- 1 Ensure that Bluetooth is enabled on both devices.
- 2 Ensure that the Bluetooth device to discover is in discoverable and connectable modes.
- 3 Ensure that the require profile is enabled on the MC32N0. See [Profiles Tab on page 114](#) for more information.
- 4 Ensure that the two devices are within 10 meters (32.8 feet) of one another.
- 5 Touch the Bluetooth icon and select **Show BTE Explorer**.



Note: If favorite connections have already been created, the Favorites screen displays. If no favorite connections have been created, the **New Connection Wizard** screen displays.

- 6 Touch **File > New Connection**.

Figure 102: BTE Explorer New Connection Wizard



- 7 Select **Explore Services on Remote Device** or another from the drop-down list and touch **Next**.



Note: If a device discovery action has not been previously performed, a device discovery is automatically initiated. If a device discovery has previously been performed, the device discovery process is skipped, and the previously found list of devices displays. To start a new device discovery, touch and hold in the window and select **Discover Devices** from the pop-up menu.

- 8 **BTE Explorer** searches for Bluetooth devices in the area.
The discovered devices display in the **Select Remote Device** window.
- 9 Select a device from the list and touch **Next**. The MC32N0 searches for services on the selected Bluetooth device.

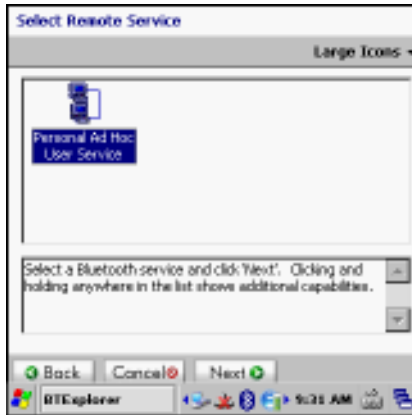
Figure 103: Device Services

Note: If the MC32N0 discovers a service but the service is not supported, the service icon is grayed-out.

- 10 Select a service from the list and press **Next**.

Figure 104: Connection Favorite Options Window

- 11 In the **Favorite Name** text box, enter a name for this service that will appear in the **Favorite** window and then touch **Next**.
- 12 Tap **Connect** to add the service to the **Favorite** window and connect to the service.

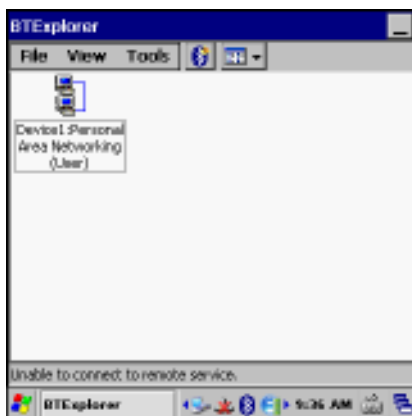
Figure 105: Favorites Window

Pairing with Discovered Device(s)

Pairing is a relationship created between the MC32N0 and another Bluetooth device in order to exchange information in a secure manner. Pairing involves entering the same PIN on the two devices. After pairing and turning on the Bluetooth radios, the devices recognize the pairing and can exchange information without re-entering a PIN.

To pair with a discovered Bluetooth device:



Note: If favorite connections have already been created, the **Favorites** screen displays. If no favorite connections have been created, the **New Connection Wizard** screen displays.

Procedure:

- 1 Touch the **Bluetooth** icon and select **Show BTE Explorer**. The **BTE Explorer** window appears.
- 2 Touch **File > New Connection**. The **New Connection Wizard** window appears.
- 3 In the drop-down list, select **Pair with Remote Device**.
- 4 Touch **Next**. The **Select Remote Device** window appears.



Note: Devices discovered previously are listed to save time. To start a new device discovery, tap and hold on the list area and select **Discover Devices** from the pop-up menu.

Figure 106: Select Remote Device Window



- 5 Select a device from the list and touch **Next**. The **Confirm Connection** window appears.

Figure 107: Confirm Connection Window



- 6 If the remote device requires a number verification, ensure that the number displayed matches the remote device. Touch **Yes**.
- 7 On the other device accept the pairing request. The **Pairing Status** window appears.
- 8 Touch **Finish**. The devices are successfully paired. The device name moves to the **Trusted Devices** window.

Deleting a Paired Device

To delete a device no longer needed:

Procedure:

- 1 Touch the **Bluetooth** icon and select **Show BTE Explorer**. The **BTE Explorer** window appears.
- 2 Touch **Tools > Trusted Devices**. The **Trusted Devices** window appears.
- 3 Touch and hold on the device select **Delete Link Key** in the pop-up menu.
- 4 In the confirmation dialog, touch **Yes**.

Accepting a Pairing Request

When a remote device wants to pair with the MC32N0, grant access when requested.

Procedure:

- 1 Ensure that the MC32N0 is set to discoverable and connectable. See *Device Info Tab on page 112*. When prompted to pair with the remote device the **Numeric Compare Authentication** window appears.

Figure 108: Numeric Compare Authentication



- 2 Ensure that the number displayed appears on the remote device.
- 3 Touch **Yes**.

Bluetooth Settings

Use the **BTE Explorer Settings** window to configure the operation of the BTE Explorer application. Touch **Menu > Settings**. The **BTE Explorer Settings** window appears.

Device Info Tab

Use the Device Info tab to configure the MC32N0's Bluetooth connection modes.

Table 20: Device Info Tab Data

Item	Description
Device Name	Displays the name of the MC32N0.
Discoverable Mode	Select whether or not the MC32N0 is discoverable by other Bluetooth devices.
Connectable Mode	Select whether or not the MC32N0 is connectable by other Bluetooth devices.

Services Tab

Use the Services tab to add or delete Bluetooth services.

Security Tab

Security settings allows you to set global security policies for Bluetooth. Note that these settings are only active on local Services that are set to Authenticate or Authenticate/Encryption. You can set authentication on local Services under the Services tab.

To adjust the security settings for an individual service, select the Services tab first, then select the individual service, then Properties.



Note: To use PIN Code, select Authenticate or Authenticate/Encrypt from the Service Security drop-down list on each local service

Table 21: Security Tab Data

Item	Description
Use PIN Code (Incoming Connection)	Select for automatic use of the PIN code entered in the PIN Code text box. It is recommended not to use this automatic PIN code feature. See Security on page 102 for more information.
PIN Code	Enter the PIN code.
Encrypt Link On All Outgoing Connections	Select to enable or disable encryption on all outgoing connections to other Bluetooth devices.

Discovery Tab

Use the Discovery tab to set and modify discovered devices.

Table 22: Discovery Tab Data

Item	Description
Inquiry Length	Sets the amount of time the MC32N0 takes to discover Bluetooth devices in the area.
Name Discovery Mode	Select either Automatic or Manual to automatically attempt to discover a Bluetooth device's name after finding the device.
Discovered Devices - Delete Devices	Deletes all discovered devices and link keys from memory.
Discovered Devices - Delete Linked Keys	Removes all pairing from remote Bluetooth devices, and makes them all un-trusted.

Virtual COM Port Tab

Virtual COM Port defines which COM ports BTE Explorer attempts to use for virtual COM ports. Check the appropriate checkbox to use the port as a virtual COM port. When finished, choose Apply to enforce changes, or Revert to restore the original settings.

Table 23: Virtual COM Port Tab Data

Item	Description
COM5:Bluetooth	Enable or disable COM Port 5.
COM9:Bluetooth	Enable or disable COM Port 9.
COM11:Bluetooth	Enable or disable COM Port 11.
COM21:Bluetooth	Enable or disable COM Port 21.
COM22:Bluetooth	Enable or disable COM Port 22.
COM23:Bluetooth	Enable or disable COM Port 23.

HID Tab

Use the HID tab to select The Human Interface Device Profile programming interface defines the protocols and procedures to be used to implement HID capabilities.

Provides support for devices such as mice, joysticks, keyboards.

Table 24: HID Tab Data

Item	Description
Enable Key Repeat	Enables key repeat functionality.
Delay	To increase key repeat delay, drag the Delay slider to the right. To decrease key repeat delay, drag the Delay slider to the left.
Rate	To increase key repeat speed, drag the Rate slider to the left. To decrease key repeat speed, drag the Rate slider to the right.

Profiles Tab

Use the Profile tab to load or remove Bluetooth services profiles. If a profile is not used, it can be removed to save memory.

- Touch a check box next to the profile to load (activate). The Serial Port profile is always active and cannot be removed.
- Touch Select All to select all profiles or touch Deselect All to deselect all profiles.
- Touch Apply to activate the profiles and then Close to exit the application.

System Parameters

Table 25: System Tab Data

Item	Description
Page Timeout	Sets the amount of time the MC32N0 searches for a device before moving on the next device.
Link Supervision Timeout	Sets the amount of time that the MC32N0 will wait for a device to come back into range after it has gone out of range. If the device does not come back into range by the set time, the MC32N0 drops the connection.

Miscellaneous Tab

Table 26: System Tab Data

Item	Description
Highlight Connections	Select the connection type to highlight when connected. In the Wizard Mode, the only options are Favorites or None. In the Explorer Mode the options are None, Tree View Only, List View Only, or Tree and List View.
Apply Text Style	Select the text style to apply to the connection text.
Apply Text Color	Select the text color to apply to the connection text.

Services Tab



Note: Ensure that the MC32N0 is discoverable and connectable when remote devices use MC32N0 services.

Use the Services tab to add or delete Bluetooth services.

To add a service:

Procedure:

- 1 Touch **Add**. The **Add Local Service** window displays.

Figure 109: Add Local Service Window



- 2 In the list, select a service to add.
- 3 Touch **OK**. The **Edit Local Service** window displays for the selected service.
- 4 Select the appropriate information and then touch **OK**. See the following sections for information on the available services.

Chapter 4

Data Capture

The MC32N0 offers the following data capture options:

- imager.
- laser scanner.
- RS507 Hands-free imager.



Note:

DataWedge is installed and enabled on the MC32N0 by default.

On Android devices, by default, the good decode beep is set to system volume (Music and Media). The good decode beep can be set to another sound (Notifications or Alarms) and the volume can be independently controlled. See the *DataWedge* section in the *MC32N0 Integrator Guide* for more information.

Imager

The device with an integrated imager has the following features:

- Omnidirectional reading of a variety of bar code symbologies, including the most popular linear, postal, PDF417, and 2D matrix code types.
- Advanced intuitive laser aiming cross-hair for easy point-and-shoot operation.

The imager uses digital camera technology to take a digital picture of a bar code, stores the resulting image in its memory, and executes state-of-the-art software decoding algorithms to extract the data from the image.

Operational Modes

The device with an integrated imager supports two modes of operation, listed below. Activate each mode by pressing a scan button.

- **Decode Mode:** In this mode, the device attempts to locate and decode enabled bar codes within its field of view. The imager remains in this mode as long as the user holds the scan button, or until it decodes a bar code.



Note: To enable Pick List Mode, configure in DataWedge.

- **Pick List Mode:** This mode allows the user to selectively decode a bar code when more than one bar code is in the device's field of view. To accomplish this, move the aiming crosshair over the required bar code to decode only this bar code. This feature is ideal for pick lists containing multiple bar codes and manufacturing or transport labels containing more than one bar code type (either 1D or 2D).

Laser Scanner

The MC32N0 with laser scanner has the following features:

- Reading of a variety of bar code symbologies, including the most popular linear, postal, and 1-D code types.
- Intuitive aiming for easy point-and-shoot operation.

RS507 Hands-Free Imager

The RS507 Hands-free Imager is a wearable bar code scan solution for both 1D and 2D bar code symbologies. The scanner supports Bluetooth Human Interface Device (HID) connection to the device.

Figure 110: RS507 Hands-Free Imager

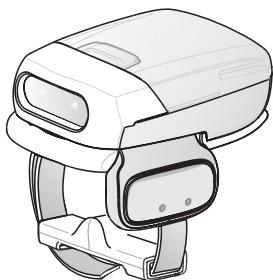

See to the *RS507 Hands-free Imager Product Reference Guide* for more information.

Scanning Considerations

Typically, scanning is a simple matter of aim, scan, and decode where a few quick trial efforts master it. However, consider the following to optimize scanning performance:

- Range
 - Any scanning device decodes well over a particular working range — minimum and maximum distances from the bar code. This range varies according to bar code density and scanning device optics.
 - Scanning within range brings quick and constant decodes; scanning too close or too far away prevents decodes. Move the scanner closer and farther away to find the right working range for the bar codes being scanned.
- Angle
 - Scan angle is important for promoting quick decodes. When laser beams reflect directly back into the scanner from the bar code, this specular reflection can “blind” the scanner.
 - To avoid this, scan the bar code so that the beam does not bounce directly back. But do not scan at too sharp an angle; the scanner needs to collect scattered reflections from the scan to make a successful decode. Practice quickly shows what tolerances to work within.
- Hold the device farther away for larger symbols.
- Move the device closer for symbols with bars that are close together.



Note: Scanning procedures depend on the application and device configuration. An application may use different scanning procedures from those described.

Bar Code Capture with Imager

To capture bar code data:

Procedure:

- 1 Ensure that an application is open on the device and a text field is in focus (text cursor in text field).
- 2 Point the top of the device at a bar code.

Figure 111: Bar Code Scanning – MC32N0–G

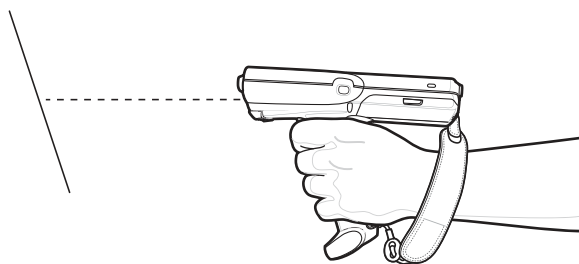
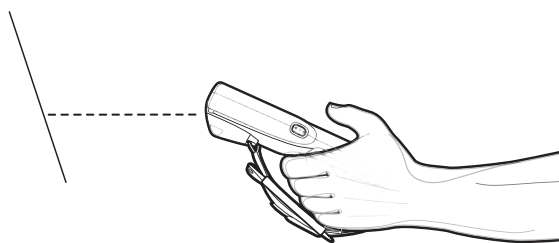

Figure 112: Bar Code Scanning – MC32N0–S



- 3 Press and hold the Scan button or Trigger.

The red laser aiming pattern turns on to assist in aiming. Ensure the bar code is within the area formed by the cross-hairs in the aiming pattern. The aiming dot is used for increased visibility in bright lighting conditions.

The Scan LEDs light green and a beep sounds, by default, to indicate the bar code was decoded successfully. Note that when the device is in Pick List Mode, the device does not decode the bar code until the center of the crosshair touches the bar code.

Figure 113: Aiming Pattern

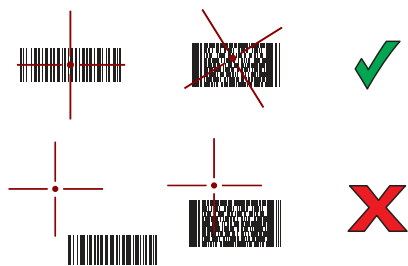

Figure 114: Pick List Mode with Multiple Bar Codes in Aiming Pattern

- 4 Release the scan button or Trigger.
- 5 The captured data appears in the text field.

Bar Code Capture with Laser Scanner

To capture bar code data:

Procedure:

- 1 Ensure that an application is open on the device and a text field is in focus (text cursor in text field).
- 2 On the MC32N0-R, rotate the Turret for optimal scanning position.
- 3 Point the scan exit window at a bar code.

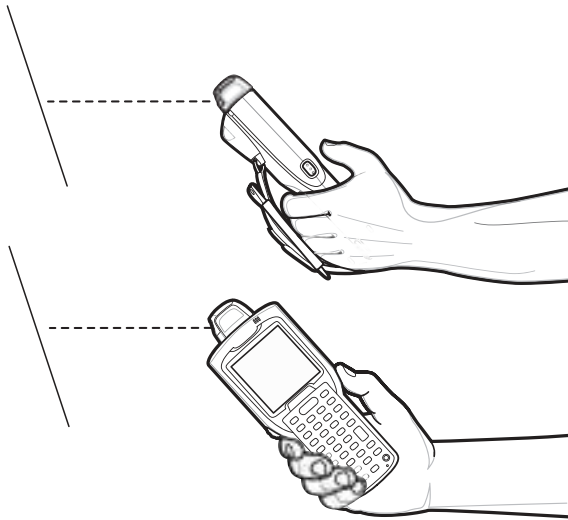
Figure 115: Bar Code Scanning – MC32N0-R

- 4 Press and hold the Scan button.

The red scan line turns on to assist in aiming. Ensure that the scan line crosses every bar and space of the bar code.

The Scan LEDs light green and a beep sounds, by default, to indicate the bar code was decoded successfully.

Figure 116: Linear Scanner Aiming Pattern

- 5 Release the scan button.
- 6 The captured data appears in the text field.

Bar Code Capture with RS507 Hands-Free Imager

Prerequisites: Pair the RS507 with the MC32N0. See [Pairing the RS507 Hands-Free Imager Using SSI on Android on page 122](#), [Pairing the RS507 Hands-Free Imager Bluetooth HID on Android on page 122](#), [Pairing the RS507 Hands-Free Imager Using SSI on WinCE on page 123](#) or [Pairing the RS507 Hands-Free Imager Bluetooth HID on WinCE on page 124](#) for more information.

Procedure:

- 1 Ensure that an application is open on the device and a text field is in focus (text cursor in text field).
- 2 Point the RS507 at a bar code.

Figure 117: Bar Code Scanning with RS507

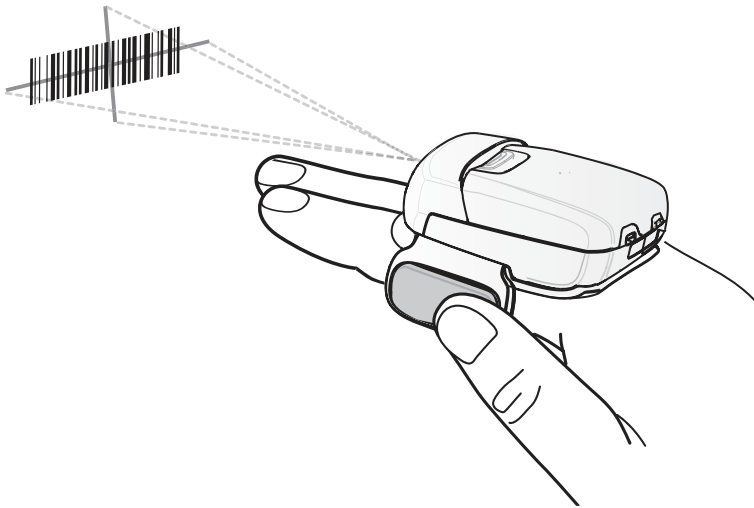

- 3 Press and hold the trigger.

The red laser aiming pattern turns on to assist in aiming. Ensure the bar code is within the area formed by the cross-hairs in the aiming pattern. The aiming dot is used for increased visibility in bright lighting conditions.

The RS507 LEDs light green, a beep sounds to indicate the bar code was decoded successfully. Note that when the RS507 is in Pick List Mode, the RS507 does not decode the bar code until the center of the crosshair touches the bar code.

Figure 118: Aiming Pattern

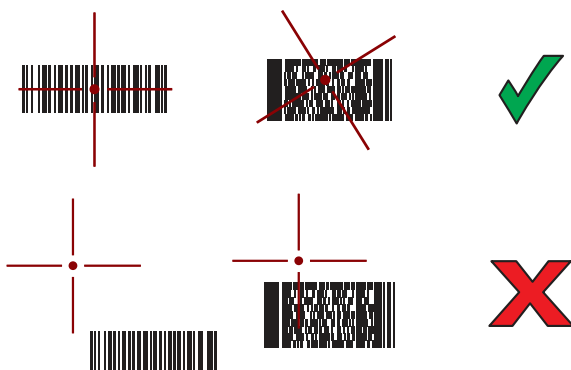

Figure 119: Pick List Mode with Multiple Bar Codes in Aiming Pattern

- 4 The captured data appears in the text field.

Pairing the RS507 Hands-Free Imager Using SSI on Android

An RS507 Hands-free Imager can be used with the device to capture bar code data.

Procedure:





- 1 Ensure that the two devices are within 10 meters (32.8 feet) of one another.
- 2 Install the battery into the RS507.
- 3 On the MC32N0, touch .
- 4 Touch .

Figure 120: Bluetooth Pairing Utility

- 5 Using the RS507, scan the bar code on the screen.
The RS507 emits a high/low/high/low beeps. The Scan LED flashes green indicating that the RS507 is attempting to establish connection with the MC32N0. When connection is established, the Scan LED turns off and the RS507 emits one string of low/high beeps.
- 6 On the MC32N0, touch .

Pairing the RS507 Hands-Free Imager Bluetooth HID on Android

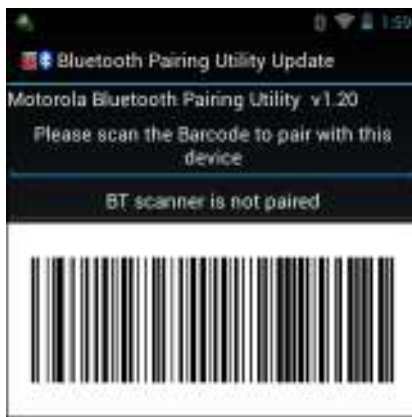
An RS507 Hands-free Imager can be used with the device to capture bar code data.



Procedure:

- 1 Ensure that Bluetooth is enabled on both devices.
- 2 Ensure that the Bluetooth device to discover is in discoverable mode.
- 3 Ensure that the two devices are within 10 meters (32.8 feet) of one another.
- 4 Place the RS507 in Human Interface Device (HID) mode. If the RS507 is already in HID mode, skip to step 5.

- a Remove the battery from the RS507.
- b Press and hold the Restore key.
- c Install the battery onto the RS507.
- d Keep holding the Restore key for about five seconds until a chirp is heard and the Scan LEDs flash green.
- e Scan the bar code below to place the RS507 in HID mode.

Figure 121: RS507 Bluetooth HID Bar Code



- 5 Remove the battery from the RS507.
- 6 Re-install the battery into the RS507.
- 7 On the MC32N0, touch .
- 8 Touch .
- 9 Touch  **Bluetooth**.
- 10 Touch **SCAN FOR DEVICES**. The device begins searching for discoverable Bluetooth devices in the area and displays them under **AVAILABLE DEVICES**.
- 11 Scroll through the list and select RS507.
The device connects to the RS507 and **Connected** appears below the device name. The Bluetooth device is added to the **Bluetooth devices** list and a trusted (“paired”) connection is established.

Pairing the RS507 Hands-Free Imager Using SSI on WinCE

An RS507 Hands-free Imager can be used with the device to capture bar code data.

Procedure:

- 1 Ensure that the two devices are within 10 meters (32.8 feet) of one another.
- 2 Install the battery into the RS507.
- 3 On the MC32N0, touch **Start > Programs > BTScannerCtlPanel**.
- 4 If required, select the **BT Scanner** checkbox and then select the appropriate Com port from the drop-down list.
- 5 Touch **Save and Exit**.
- 6 Touch **Start > Programs > MotoBTUI**.
- 7 Touch **Pairing Barcode**. A bar code displays.

Figure 122: Pairing Barcode



- 8 Point the RS507 at the bar code. The RS507 reads the bar code and begins pairing with the MC32N0.

Pairing the RS507 Hands-Free Imager Bluetooth HID on WinCE

An RS507 Hands-free Imager can be used with the device to capture bar code data.



Note: The Bluetooth HID profile is only supported when using the StoneStreet One Bluetooth stack.

Procedure:

- 1 Ensure that Bluetooth is enabled on both devices.
- 2 Ensure that the Bluetooth device to discover is in discoverable mode.
- 3 Ensure that the two devices are within 10 meters (32.8 feet) of one another.
- 4 Place the RS507 in Human Interface Device (HID) mode. If the RS507 is already in HID mode, skip to step 5.
 - a Remove the battery from the RS507.
 - b Press and hold the Restore key.
 - c Install the battery onto the RS507.
 - d Keep holding the Restore key for about five seconds until a chirp is heard and the Scan LEDs flash green.
 - e Scan the bar code below to place the RS507 in HID mode.

Figure 123: RS507 Bluetooth HID Bar Code



- 5 Remove the battery from the RS507.
- 6 Re-install the battery into the RS507.
- 7 On the MC32N0, use StoneStreet One to search for the RS507.
- 8 Scroll through the list. Select **RS507** and then create a new connection

DataWedge on Android

DataWedge is a utility that adds advanced bar code scanning capability to any application without writing code. It runs in the background and handles the interface to built-in bar code scanners. The captured bar code data is converted to keystrokes and sent to the target application as if it was typed on the keypad.

To configure DataWedge refer to the *MC32N0 Integrator Guide*.





Enabling DataWedge

Procedure:

- 1 Touch .
- 2 Touch .
- 3 Press .
- 4 Touch **Settings**.
- 5 Touch the **DataWedge enabled** checkbox. A blue checkmark appears in the checkbox indicating that DataWedge is enabled.
- 6 Press .

Disabling DataWedge

Procedure:

- 1 Touch .
- 2 Touch .
- 3 Touch .
- 4 Touch **Settings**.
- 5 Touch the **DataWedge enabled** checkbox. The blue checkmark disappears from the checkbox indicating that DataWedge is disabled.
- 6 Press .

DataWedge on WinCE

DataWedge is a utility that adds advanced bar code scanning capability to any application without writing code. It runs in the background and handles the interface to built-in bar code scanners. The captured bar code data is converted to keystrokes and sent to the target application as if it was typed on the keypad.

To configure DataWedge refer to the *MC32N0 Integrator Guide*.

Enabling DataWedge

Procedure:

- 1 Touch **Start > Settings > Control Panel > DataWedge**.

Figure 124: DataWedge Settings Window



- 2 Touch **Basic configuration > 1. Barcode input**.
- 3 Tap **1. 1D Scanner Driver, 1. Block Buster Imager or 2. Bluetooth SSI Scanner Driver**.
- 4 Ensure that a check mark is next to **1. Enabled**. If not, touch **1. Enabled**.
- 5 Touch **OK**.
- 6 Tap **Running** to start the DataWedge process. The DataWedge Status changes to **Ready**.

Disabling DataWedge

Procedure:

- 1 Touch **Start > Settings > Control Panel > DataWedge**.
- 2 Touch the **Running** option to end the DataWedge process. The DataWedge Status changes to Stopped.
- 3 Touch **OK**.

Chapter 5

Accessories

This chapter provides information for using the accessories for the device.

MC32N0 Accessories

The table below lists the accessories available for the MC32N0.

Table 27: MC32N0 Accessories

Accessory	Part Number	Description
Cradles		
Single Slot Serial /USB Cradle	CRD3000-1001RR	Charges the MC32N0 main battery and a spare battery, and synchronizes the MC32N0 with a host computer through either a serial or USB connection.
Four Slot Ethernet Cradle	CRD3X01-4001ER	Charges up to four MC32N0s and provides Ethernet communications.
Four Slot Charge Only Cradle	CHS3000-4001CR	Charges up to four MC32N0s.
Chargers		
Four Slot Spare Battery Charger	SAC7X00-4000CR	Charges up to four MC32N0 spare batteries.
Battery Adapter	ADP-MC32-CUP0-01	Allows for charging of MC32N0 batteries in the Four Slot Spare Battery Charger, Single Slot USB cradle and UBC Adapter (Single-pack).
	ADP-MC32-CUP0-04	(4-pack).
Universal Battery Charger (UBC) Base	UBC2000-I500DES	Charges up to four MC32N0 spare batteries. Requires UBC Adapter and Battery Adapter.
MC3XXX Universal Battery Charger (UBC) Adapter	21-32665-45AR	Charges a single MC32N0 battery. Requires Battery Adapter. Use in conjunction with the UBC Base to charge multiple batteries.
Power Supply for Single Slot Serial/USB Cradle	PWRS-14000-148R	Provides power to the Single Slot Serial/USB cradle.
Power Supply for Four Slot Cradles	PWRS-14000-241R	Provides power to the Four Slot Charge Only and Ethernet cradles.
Power Supply for Four Slot battery Charger	PWRS-14000-242R	Provides power to the Four Slot Spare Battery Charger.

Table continued...

Accessory	Part Number	Description
Power Supply for Charging Cables	PWRS-14000-249R	Provides power to the Charge Only cable, RS232 Charge cable and USB Client Charge cable.
US AC Line Cord	23844-00-00R	Provides power to 3-wire power supplies PWRS-14000-148R and PWRS-14000-241R.
International AC Line Cord	50-16000-271R 50-16000-218R 50-16000-219R 50-16000-220R 50-16000-221R 50-16000-256R 50-16000-257R 50-16000-669R 50-16000-671R 50-16000-672R 50-16000-678R 50-16000-727R	Provides power to 3-wire power supplies PWRS-14000-148R and PWRS-14000-241R.
US AC Line Cord	50-16000-182R	Provides power to the 2-wire power supply PWRS-14000-249R.
International AC Line Cord	50-16000-255R 50-16000-664R 50-16000-666R 50-16000-670R	Provides power to the 2-wire power supply PWRS-14000-249R.
DC Line Cord	50-16002-029R	Provides power from power supply to the Four Slot Charge Only cradle and Four Slot Ethernet cradle.
Cables		
Charge Only Cable	25-70103-03R	Provides power to the MC32N0. Requires power supply PWRS-14000-249R.
USB Client Charge Cable	25-67868-03R	Provides USB client communication capabilities and charges the MC32N0.
RS232 Charge Cable	25-67866-03R	Provides RS232 communication capabilities and charges the MC32N0.
Vehicle Charge Cable	VCA3000-01R	Changes the MC32N0 using a vehicle's cigarette lighter.
Zebra Printer Cable	25-91513-01R	Provides printer specific communication capabilities.
Single Slot Cradle RS232 Cable	25-63852-01R	Provides serial host communication through the Single Slot Serial/USB cradle.

Table continued...

Accessory	Part Number	Description
Single Slot Cradle USB Cable	25-68596-01R	Provides USB communication through the Single Slot Serial/USB cradle.
Headset Adapter Cable	25-124411-02R	Connects an RCH51 headset to the MC32N0. Contains 2.5 mm jack with unique locking screw.
Miscellaneous		
Magnetic Stripe Reader	MSR3000-100R	Reads magnetic stripe cards.
Cradle Modem Kit	KT-MC3000SERMO-DEMR	Provides modem connectivity to the Single Slot Serial/USB cradle. Kit includes Modem Dongle and Modem Adapter Cable. Note: Not supported on Android devices.
2740 mAh Battery	BTRY-MC32-01-01	Replacement standard capacity (1X) battery.
	BTRY-MC32-01-10	Replacement standard capacity (1X) battery (10-pack).
4800 mAh Battery	BTRY-MC32-02-01	Replacement extended capacity (2X) battery.
	BTRY-MC32-02-10	Replacement extended capacity (2X) battery (10-pack).
Replacement Tether	KT-73440-01R	Replacement non-elastic tether for MC32N0-R and MC32N0-S (3-pack).
MC32XX-R/S Stylus and Tether Kit	11-43912-03R	Replacement stylus and tether kit (3-pack).
MC32N0-G Stylus and Tether	KT-81680-03R	Replacement stylus and tether for MC32N0-G (3-pack).
	KT-81680-50R	Replacement stylus and tether for MC32N0-G (50-pack).
MC32N0-G Handstrap Button	KT-97258-01R	Replacement button for MC32N0-G handstrap (250-pack).
MC32N0-G Handstrap	SG-MC3123242-01R	Replacement handstrap for MC32N0-G.
MC32N0-G Handstrap	SG-MC3123342-01R	Replacement handstrap for MC32N0-G (5-pack).
MC32N0-R/S Handstrap	SG-MC3123243-01R	Replacement handstrap for MC32N0-R and MC32N0-S.
Plastic Holster	8710-050005-01R	Provides a clip on holder for the MC32N0-R and MC32N0-S.
Fabric Holster	11-69293-01R	Provides a soft, clip on holder and a shoulder strap for the MC32N0-R and MC32N0-S.
Fabric Holster	SG-MC3021212-01R	Provides a soft, clip on holder and a shoulder strap for the MC32N0-G.
Shoulder Strap	58-40000-007R	Universal shoulder strap.
Belt	11-08062-02R	Belt for fabric holster.

Table continued...

Accessory	Part Number	Description
MC32N0-G Rubber Boot	11-72959-04R	Provides additional protection for both the MC32N0-G laser and imager configurations.
MC32N0-S Rubber Boot	11-70899-04R	Provides additional protection for both the MC32N0-S laser and imager configurations.
MC32N0-R Rubber Boot	11-72096-04R	Provides additional protection for the MC32N0-R.
Mounting Bracket	KT-136648-01	Used to mount four slot cradles onto a wall.

Battery Adapter

Use the Battery Adapter with the Single Slot Serial/USB Cradle and the Four Slot Battery Charger to allow charging of the MC32N0 batteries.

Installing the Battery Adapter

When and where to use: The Battery Adapter is required to charge MC32N0 batteries in the Single Slot Serial/USB cradle, the Four Slot Battery Charger or the UBC Adapter.

Procedure:

- 1 Remove power from the cradle or charger.
- 2 Insert the end of the Battery Adapter into the battery slot.
- 3 Rotate the Battery Adapter down into the battery slot.

Figure 125: Battery Adapter in Single Slot Serial/USB Cradle

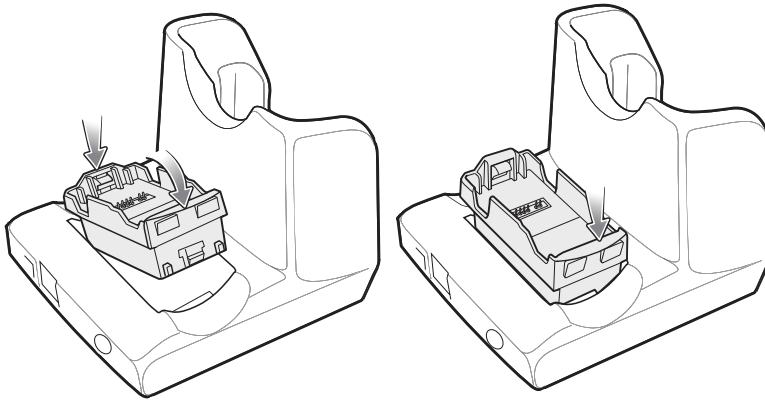

Note:

On the Four Slot Battery Charger, install the Battery Adapter into the two front slots before installing into the two rear slots.

If charging both MC3200 and MC3100 batteries in the charger, install the MC3200 battery adapter in the back slots and install the MC3100 batteries in the front slots.

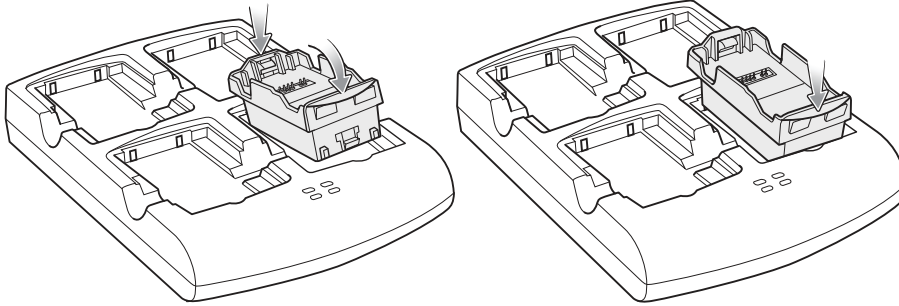
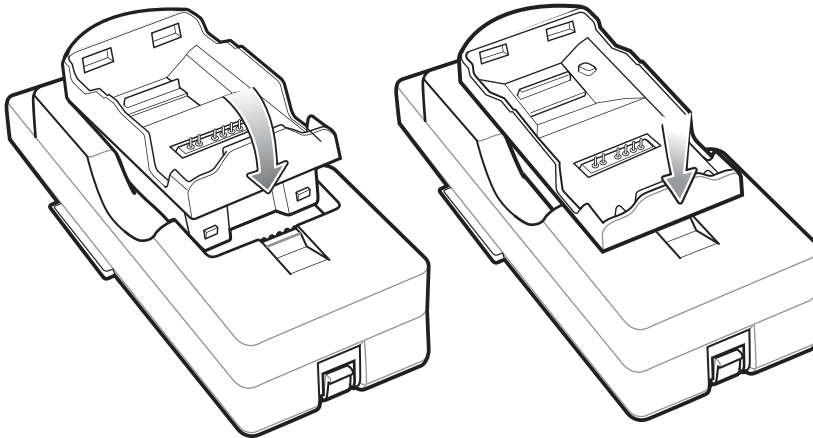
Figure 126: Battery Adapter in Four Slot Battery Charger**Figure 127: Battery Adapter in UBC Adapter**

- 4 Press the Battery Adapter down to ensure that it is properly seated.
- 5 Reconnect power.

Removing the Battery Adapter

Procedure:

- 1 Remove power from the cradle or charger.
- 2 Remove the battery from Battery Adapter.
- 3 Slide the release latch toward the contact pins.

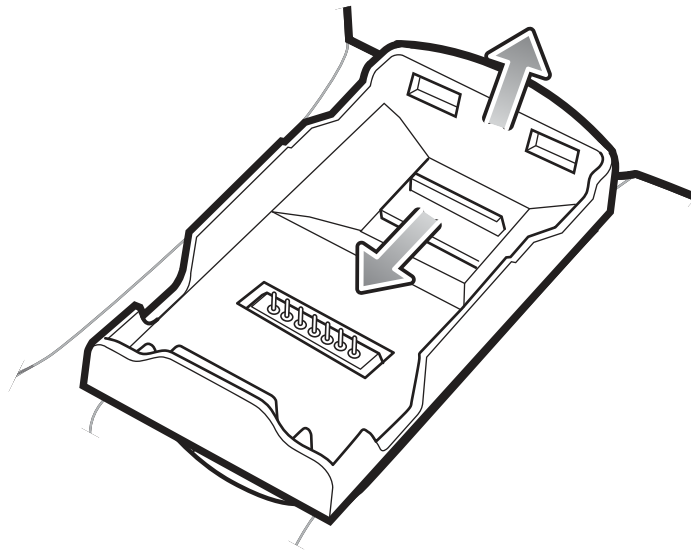
Figure 128: Release Latch

- 4 Rotate the Battery Adapter up.
- 5 Remove the Battery Adapter from the battery slot.
- 6 Reconnect power.

Single Slot Serial/USB Cradle



Caution: Ensure that you follow the guidelines for battery safety described in [Battery Safety Guidelines on page 151](#).

The Single Slot Serial/USB cradle:

- Provides 5.4VDC power for operating the mobile computer, charging the battery and charging a spare battery.
- Provides a serial port and a USB port for data communication between the mobile computer and a host computer or other serial devices (e.g., a printer).
- Synchronizes information between the mobile computer and a host computer. With customized or third party software, it can also synchronize the mobile computer with corporate databases.
- Provides serial connection through the serial pass-through port for communication with a serial device, such as a host computer.
- Provides USB connection through the USB pass-through port for communication with a USB device, such as a host computer.

Charging the MC32N0 Battery

Procedure:

- 1 Ensure that the cradle is connected to power.
- 2 Slide the mobile computer into the slot in the cradle. The mobile computer amber Charge LED Indicator, indicates the mobile computer battery charging status.

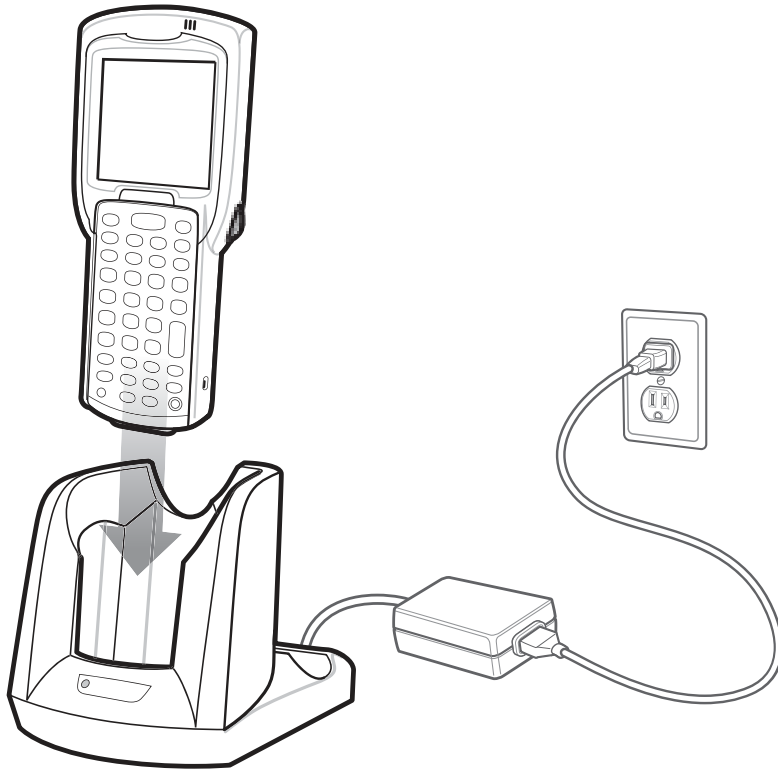
Figure 129: MC32N0 Battery Charging

- 3 Gently press down on the device to ensure proper contact.
- 4 When charging is complete, remove the mobile computer from the cradle slot.

Charging an MC32N0 Spare Battery

Procedure:

- 1 Ensure that the cradle is connected to power.
- 2 Ensure that the Battery Adapter into the spare battery slot on the cradle. See [Battery Adapter on page 130](#).
- 3 Insert the spare battery into the battery adapter, bottom first, and pivot the top of the battery down onto the contact pins.

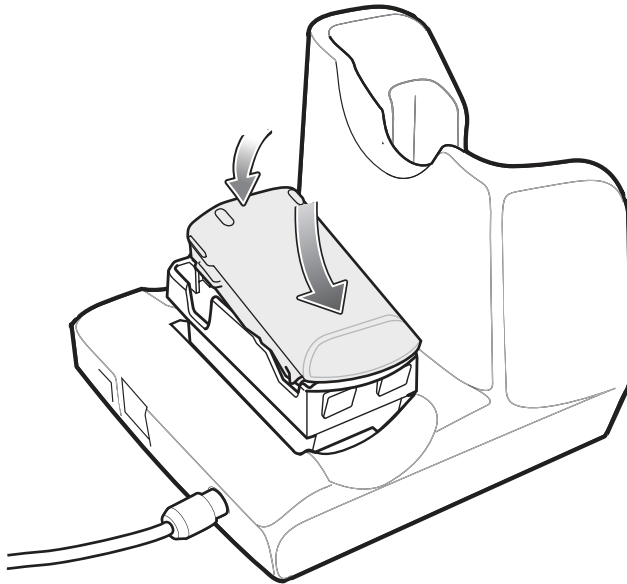
Figure 130: MC32N0 Spare Battery Charging

- 4 Gently press down on the battery to ensure proper contact.
The Spare Battery Charging LED on the front of the cradle indicates the spare battery charging status.
- 5 When charging is complete, press the battery clip and lift the battery out of the slot.

Battery Charging in Single Slot Serial/USB Cradle

The Single Slot Serial/USB cradle charges the M32N0's main battery and a spare battery simultaneously.

The MC32N0's Charge LED indicates the status of the battery charging in the MC32N0. See [Table 7: LED Charge Indicators on page 31](#) for charging status indications.

The spare battery charging LED on the cradle indicates the status of the spare battery charging in the cradle. See below for charging status indications.

Table 28: Spare Battery LED Charging Indicators

Spare Battery LED (on cradle)	Indication
Slow Blinking Amber	Spare battery is charging.
Solid Amber	Charging complete.
Fast Blinking Amber	Error in charging; check placement of spare battery.
Off	No spare battery in slot; spare battery not placed correctly; cradle is not powered.

Charging Temperature

Charge batteries in temperatures from 0 °C to 40 °C (32 °F to 104 °F). Charging is intelligently controlled by the MC32N0.

To accomplish this, for small periods of time, the MC32N0 or cradle alternately enables and disables battery charging to keep the battery at acceptable temperatures. The MC32N0 or cradle indicates when charging is disabled due to abnormal temperatures via its LED.

Four Slot Charge Only Cradle



Caution: Ensure that you follow the guidelines for battery safety described in *Battery Safety Guidelines on page 151*.

The Four Slot Charge Only cradle:

- Provides 5.4 VDC power for operating the mobile computer and charging the battery.
- Simultaneously charges up to four mobile computers.

Figure 131: Four Slot Charge Only Cradle

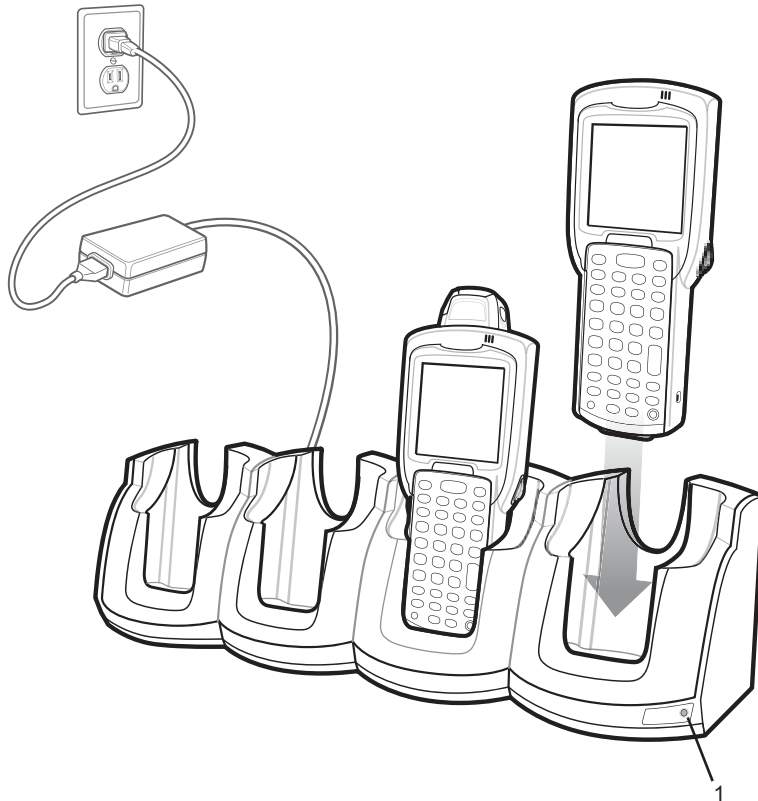

Table 29: Four Slot Charge Only Cradle LED

Item	Description
1	Power LED

Charging the MC32N0 Battery

Procedure:

- 1 Ensure that the cradle is connected to power.
- 2 Slide the mobile computer into the slot in the cradle. The mobile computer amber Charge LED Indicator, indicates the mobile computer battery charging status.
- 3 Gently press down on the device to ensure proper contact.
- 4 When charging is complete, remove the mobile computer from the cradle slot.

Battery Charging in the Four Slot Charge Only Cradle

The MC32N0's Charge LED indicates the status of the battery charging in the MC32N0. See [Table 7: LED Charge Indicators on page 31](#) for charging status indications.

The Standard Battery charges in less than five hours and the Extended Battery charges in less than eight hours.

Charging Temperature

Charge batteries in temperatures from 0 °C to 40 °C (32 °F to 104 °F). Charging is intelligently controlled by the MC32N0.

To accomplish this, for small periods of time, the MC32N0 or cradle alternately enables and disables battery charging to keep the battery at acceptable temperatures. The MC32N0 or cradle indicates when charging is disabled due to abnormal temperatures via its LED.

Four Slot Ethernet Cradle



Caution: Ensure that you follow the guidelines for battery safety described in [Battery Safety Guidelines on page 151](#).

The Four Slot Ethernet cradle:

- Provides 5.4 VDC power for operating the mobile computer.
- Connects the mobile computer (up to four) to an Ethernet network.

Figure 132: Four Slot Ethernet Cradle

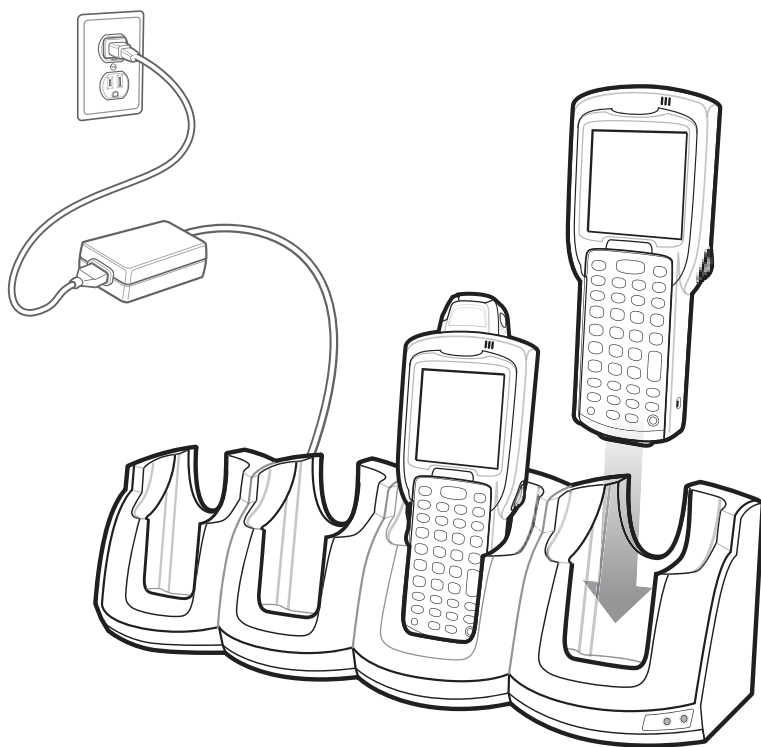



Establishing Ethernet Connection



Note: Refer to the *MC32N0 Integrator Guide* for information on configuring the Ethernet settings.

Procedure:

- 1 Touch .
- 2 Touch **Ethernet**.
- 3 Slide the Ethernet switch to the **ON** position.
- 4 Insert the MC32N0 into a slot.
The  icon appears in the Status bar.
- 5 Touch **Eth0** to view Ethernet connection details.

Ethernet Cradle Drivers



Note: On MC32N0 devices with WinCE only.

The Ethernet cradle drivers are pre-installed on the MC32N0 and initiate automatically when the MC32N0 is placed in a properly connected Four Slot Ethernet cradle.

When the mobile computer is inserted into the Four Slot Ethernet cradle, the LAN icon indicates that the mobile computer is connected to a network.

Double-tap the LAN icon to open the **LANNDS1** window. This window displays the TCP/IP information for the mobile computer.

Figure 133: LANNDS1 Window



LED Indicators

There are two green LEDs on the front of the cradle and two green LED on the Primary port on the back of the cradle. These green LEDs light and blink to indicate the data transfer rate. When the LEDs are not lit the transfer rate is 10 Mbps.

Table 30: CRD3X01-4001ER LED Indicators

Data Rate	Left 1000 LED	Right 100 LED
1 Gbps	On/Blink	Off
100 Mbps	Off	On/Blink

Table continued...

Data Rate	Left 1000 LED	Right 100 LED
10 Mbps	Off	Off

Charging the MC32N0 Battery

Procedure:

- 1 Ensure that the cradle is connected to power.
- 2 Slide the mobile computer into the slot in the cradle. The mobile computer amber Charge LED Indicator, indicates the mobile computer battery charging status.
- 3 Gently press down on the device to ensure proper contact.
- 4 When charging is complete, remove the mobile computer from the cradle slot.

Battery Charging in the Four Slot Ethernet Cradle

The MC32N0's Charge LED indicates the status of the battery charging in the MC32N0. See [Table 7: LED Charge Indicators on page 31](#) for charging status indications.

The Standard Battery charges in less than five hours and the Extended Life Battery charges in less than eight hours.

Charging Temperature

Charge batteries in temperatures from 0 °C to 40 °C (32 °F to 104 °F). Charging is intelligently controlled by the MC32N0.

To accomplish this, for small periods of time, the MC32N0 or cradle alternately enables and disables battery charging to keep the battery at acceptable temperatures. The MC32N0 or cradle indicates when charging is disabled due to abnormal temperatures via its LED.

Four Slot Spare Battery Charger



Caution: Ensure that you follow the guidelines for battery safety described in [Battery Safety Guidelines on page 151](#).

The Four Slot Battery Charger charges up to four MC32N0 spare batteries.

Charging Spare Batteries

Prerequisites: Before installing the battery, install the Battery Adapter into the battery slot in the Four Slot Spare Battery Charger. See [Battery Adapter on page 130](#).

Procedure:

- 1 Connect the charger to a power source.
- 2 Insert the battery into a battery adapter and gently press down on the battery to ensure proper contact.

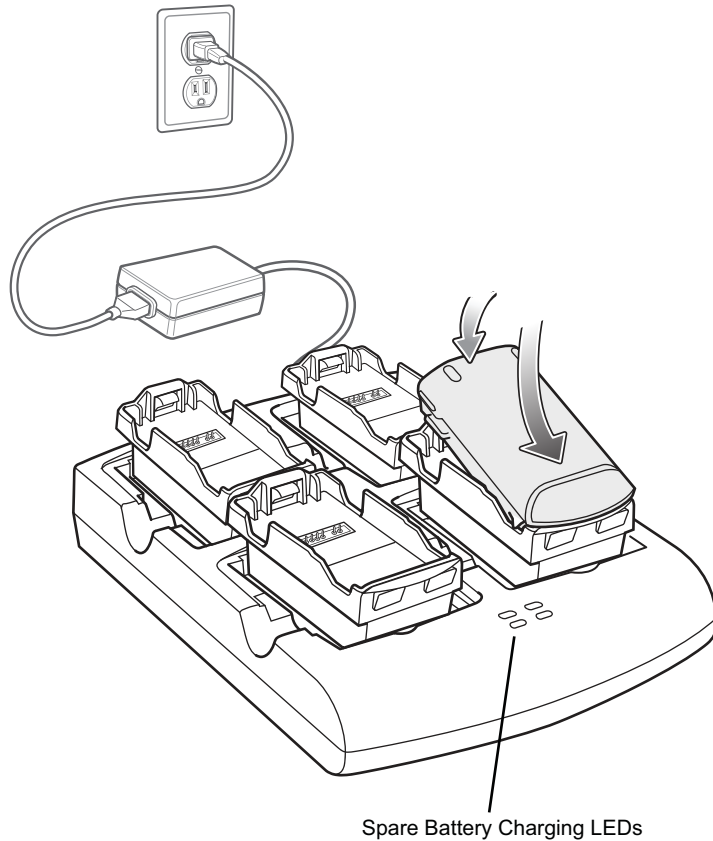
Figure 134: Four Slot Battery Charger

Battery Charging

Spare Battery Charging

Each Battery Charging LED indicates the status of the battery charging in each slot. The table below describes the Battery Charging LED status.

The Standard battery charges in less than five hours and the Extended battery fully charges in less than eight hours.

Table 31: Battery LED Charging Indicators

LED	Indication
Off	No battery in slot. Battery is not charging. Battery Adapter is not inserted correctly in the slot. Battery is not inserted correctly in Battery Adapter. Charger is not powered.
Slow blinking amber	Battery is charging.
Solid amber	Charging complete.
Fast blinking amber	Charging error.

Charging Temperature

Charge batteries in temperatures from 0 °C to 40 °C (32 °F to 104 °F). Charging is intelligently controlled by the MC32N0.

To accomplish this, for small periods of time, the charger alternately enables and disables battery charging to keep the battery at acceptable temperatures. The charger indicates when charging is disabled due to abnormal temperatures via its LED.

Magnetic Stripe Reader

The Magnetic Stripe Reader (MSR) snaps on to the bottom of the MC3200 mobile computer to allow easy data capture with the swipe of a magnetic stripe card. Simply remove the MSR when not in use.

Installing the MSR

Procedure:

- 1 Insert the mobile computer into the MSR, and push in the two locking tabs.

Figure 135: Installing the MSR

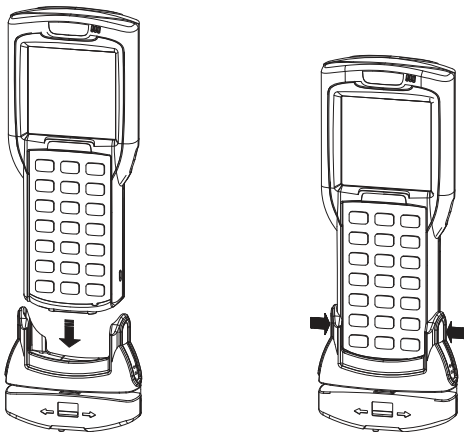

- 2 Insert the mobile computer into the MSR, and push in the two locking tabs.

Using the MSR

To use the MSR, ensure the mobile computer has an application which accepts magnetic stripe data.

Procedure:

- 1 Swipe the magnetic stripe card through the MSR, orienting the magnetic stripe in either direction, from left to right, or right to left. Data encoded on the magnetic stripe displays in the mobile computer window.

Figure 136: Card Swipe

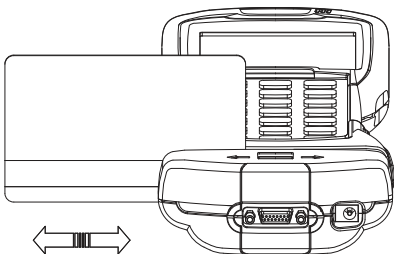

- 2 For best results, gently press down on the card while swiping to ensure contact with the bottom of the MSR.

Removing the MSR

Procedure:

- 1 Push in the bottom of the two locking tabs.

Figure 137: Removing the MSR

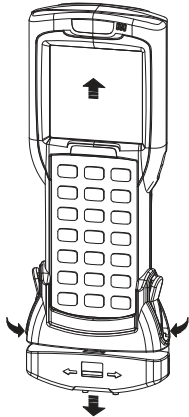

- 2 Pull the MSR from the mobile computer.

MC32N0 Cables



Caution: Ensure that you follow the guidelines for battery safety described in *Battery Safety Guidelines on page 151*.

The cables are available with a variety of connection capabilities.

Communication/Charge cables:

- Provide the mobile computer with operating and charging power when used with the Symbol approved power supply.
- Synchronize information between the mobile computer and a host computer. With customized or third party software, it can also synchronize the mobile computer with corporate databases.
- Provide serial connection through the serial pass-through port for communication with a serial device, such as a host computer. For communication setup procedures, refer to the MC32N0 Integrator Guide.
- Provide USB connection through the USB pass-through port for communication with a USB device, such as a host computer. For communication setup procedures, refer to the MC32N0 Integrator Guide.

The following Communication/Charge cables are available:

- Serial (RS232) Charge cable (9-pin D female with power input receptacle)
- USB Client Charge cable (standard-A connector and a barrel receptacle for power).

Dedicated Printer cables, provide communication with a dedicated printer.

The following printer cables are available directly from the printer manufacturer:

- O'Neil printer cable
- Zebra printer cable
- Monarch printer cable.

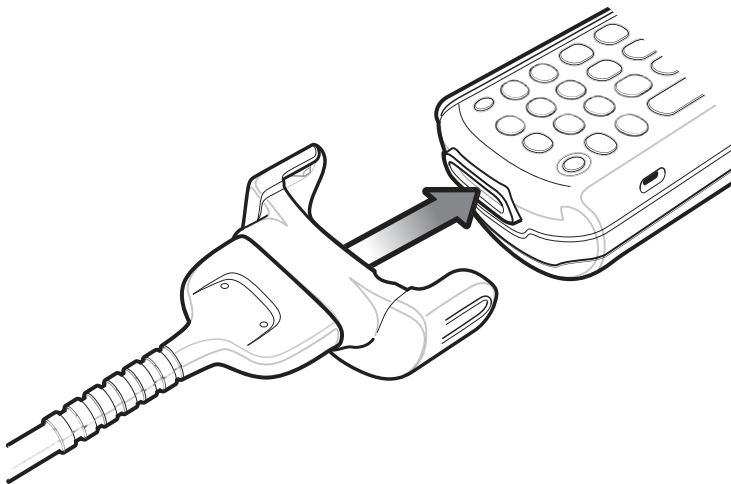
Figure 138: Cable Cup

Universal Battery Charger Adapter



Caution: Ensure that you follow the guidelines for battery safety described in [Battery Safety Guidelines on page 151](#).

The Universal Battery Charger (UBC) Adapter can be used with a power supply as a standalone spare battery charger or it can be used with the four station UBC2000 to simultaneously charge up to four spare batteries. For additional information on the UBC 2000, see the *UBC 2000 Quick Reference Guide* p/n 70-33188-xx.

Charging a Spare Battery in the UBC Adapter

Prerequisites:

Before installing the battery, ensure that the Battery Adapter has been installed into the battery slot in the Universal Battery Charger Adapter. See [Battery Adapter on page 130](#).

Ensure that the adapter is connected to power source.

Procedure:

- 1 Insert the battery into a battery adapter and gently press down on the battery to ensure proper contact.

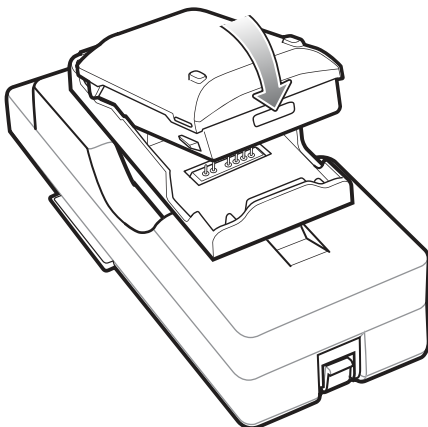
Figure 139: Universal Battery Charger Adapter

- 2 Press down on the battery to ensure it is seated properly.

UBC Adapter Battery Charging

Spare Battery Charging

The UBC Adapter charging LEDs indicate the battery charging status. The Standard Battery usually charges in less than five hours and the Extended Life Battery usually charges in less than eight hours.

Figure 140: UBC Adapter LEDs

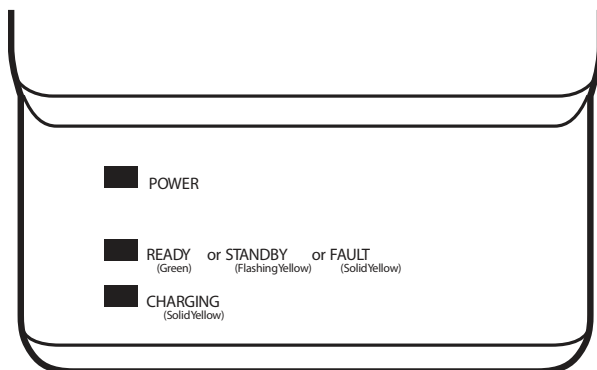
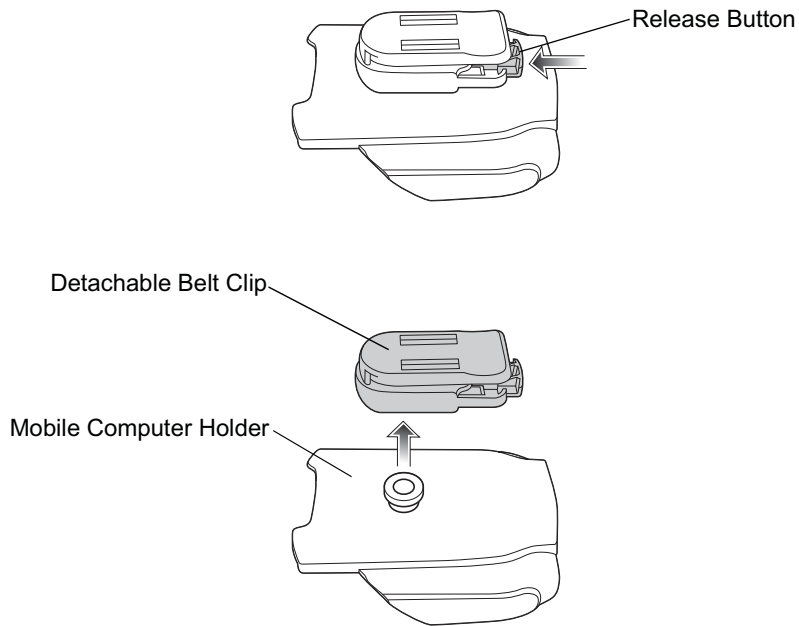

Table 32: UBC Adapter Charge LED Status Indications

LED	Indication	Description
POWER	Green	Power is connected to the UBC Adapter.
READY or	Green	Charging complete.
STAND- BY or	Flashing-Yellow	The battery was deeply discharged and is being trickle charged to bring the voltage up to the operating level. After operating level voltage is achieved, the battery charges normally.
FAULT	Yellow	Charging error, check placement of mobile computer/spare battery.
CHARG- ING	Yellow	Normal charge.

Plastic Holster

The Plastic Holster provides a holder for the mobile computer. It consists of a mobile computer holder and a detachable belt clip. Press the release button to remove the detachable belt clip.

Figure 141: Plastic Holster

The Plastic Holster provides a holder for the mobile computer. It consists of a mobile computer holder and a detachable belt clip. Press the release button to remove the detachable belt clip.

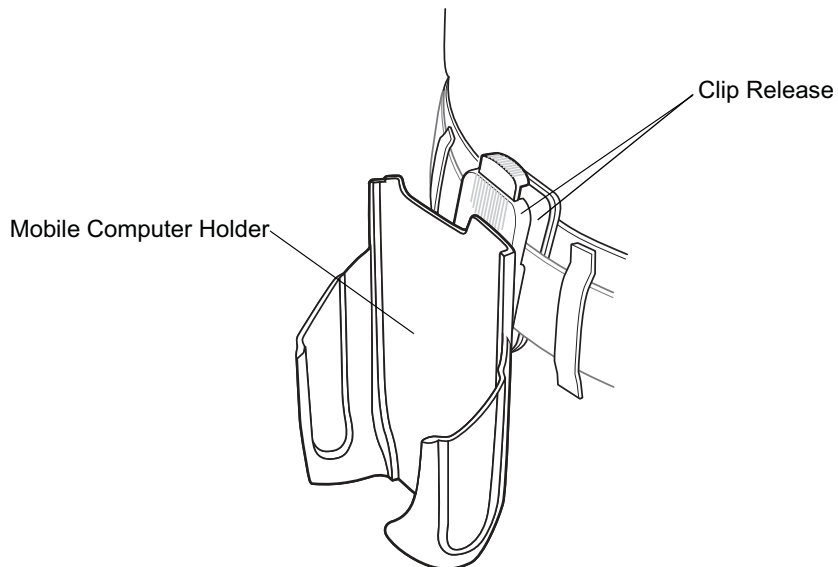
Figure 142: Attaching the Plastic Holster

The Plastic Holster holds the mobile computer on a belt or waist band.

To insert the mobile computer, slide the mobile computer into the Plastic Holster with the screen facing the user.

To remove the mobile computer, press and lift to remove the mobile computer.

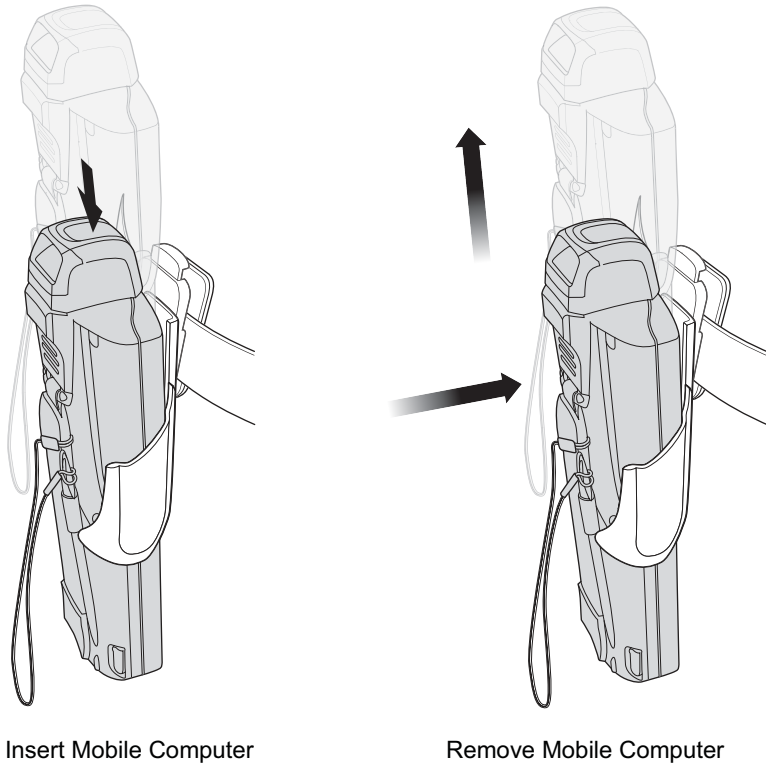
Figure 143: Insert and Remove the Mobile Computer

Fabric Holster

The Fabric Holster provides a soft holder for the mobile computer. It consists of a fabric mobile computer holder, a detachable shoulder strap and a detachable belt clip. Press the release button to remove the detachable belt clip. See figures below to remove the detachable clip and to attach the Fabric Holster to a belt and shoulder strap.

Figure 144: Fabric Holster Detachable Belt Clip

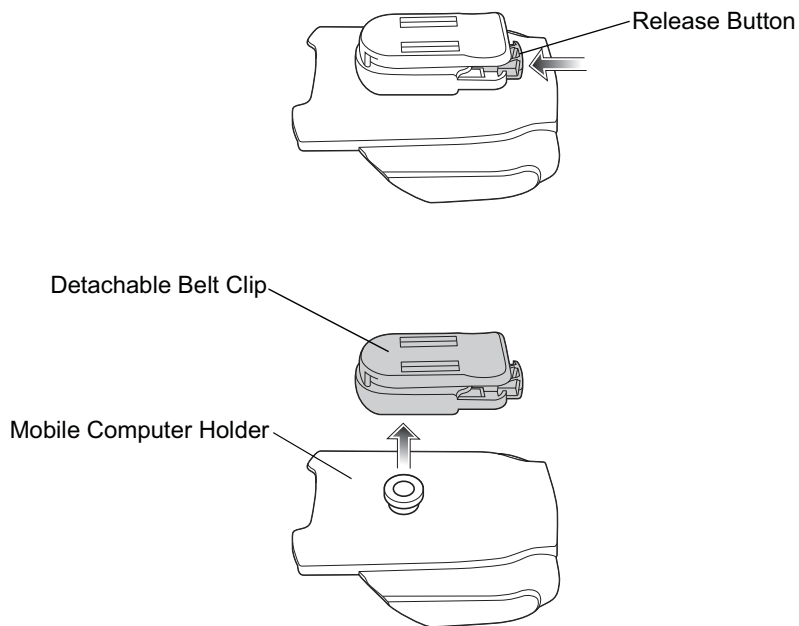

Belt Clip

Pinch the clip release and attach the Fabric Holster to a belt or waist band.

Figure 145: Attaching the Fabric Holster To a Belt

Shoulder Strap

Remove the detachable belt clip and attach the shoulder strap.

Figure 146: Attach the Fabric Holster to the Shoulder Strap

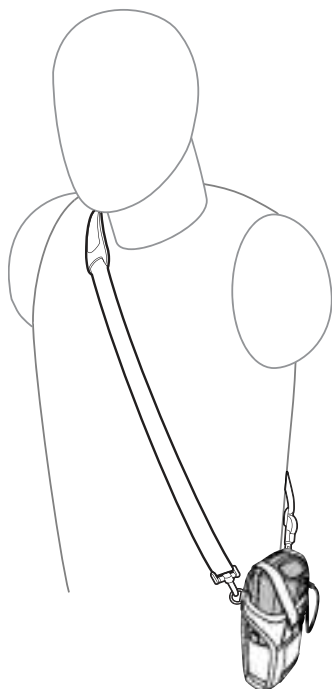

The Fabric Holster holds the mobile computer on a belt or waist band.

- To insert the mobile computer, slide the mobile computer into the Fabric Holster with the screen facing the user.
- Pull restraining strap over mobile computer and secure in the clip.
- To remove the mobile computer, pull down on restraining strap to release from clip and lift retaining strap clear.
- Lift mobile computer out of Fabric Holster.

Figure 147: Insert and Remove the MC32N0.

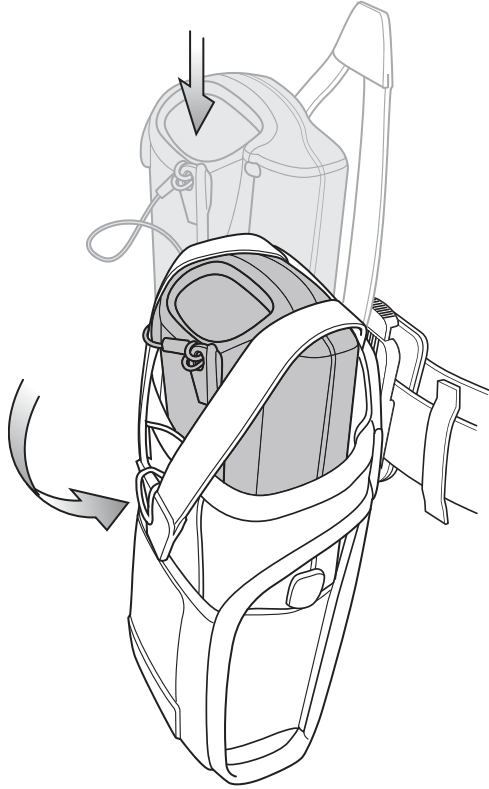

Using the Belt Clip

Procedure:

- 1 Pinch the clip release.
- 2 Attach the Fabric Holster to a belt or waist band.

Figure 148: Attaching the Fabric Holster To a Belt

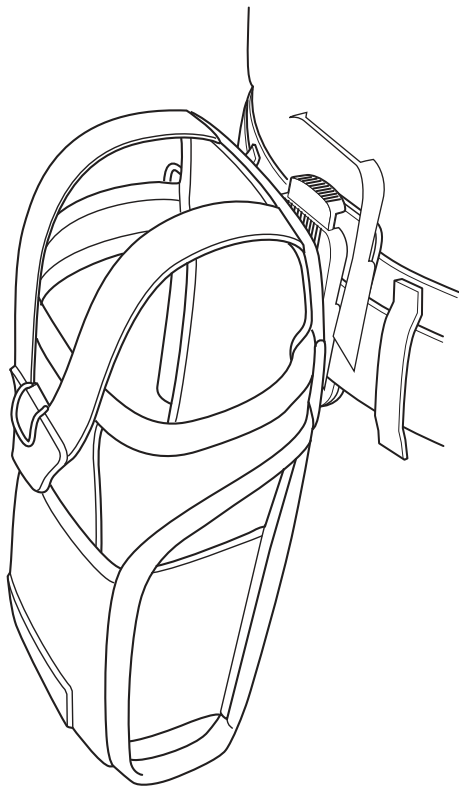

3 Lift the strap and insert the MC32N0 into the holster.

Figure 149: Insert MC32N0 in Holster

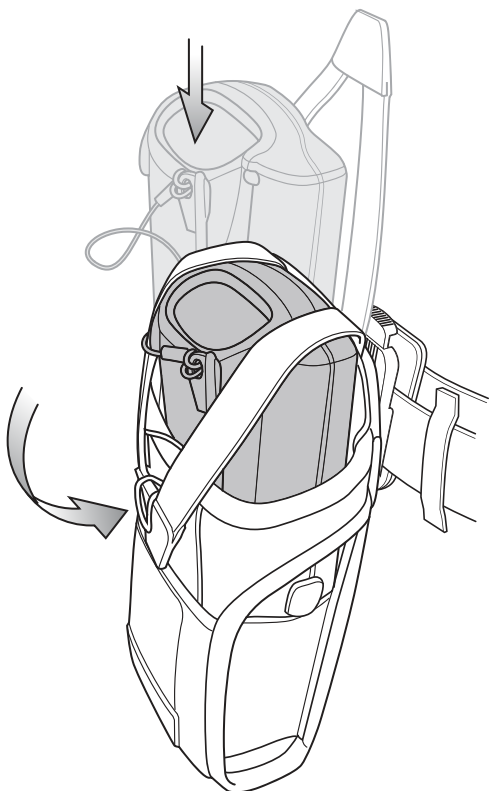

4 Secure the strap to hold the MC32N0 in place.

Using the Shoulder Strap

Procedure:

- 1 Press the release button on the top of the belt clip.
- 2 Remove the clip from the holster.

Figure 150: Remove Belt Clip

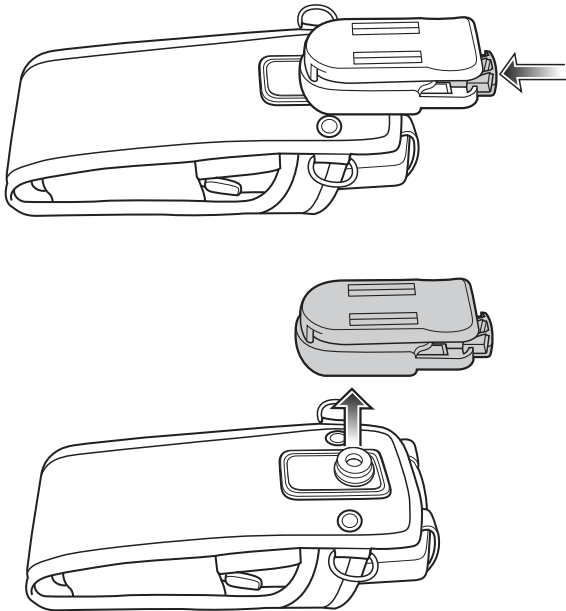

- 3 Connect the clips on the shoulder strap to the rings on the fabric holster.
- 4 Place the shoulder strap over your head and rest on your shoulder.

Figure 151: Shoulder Strap

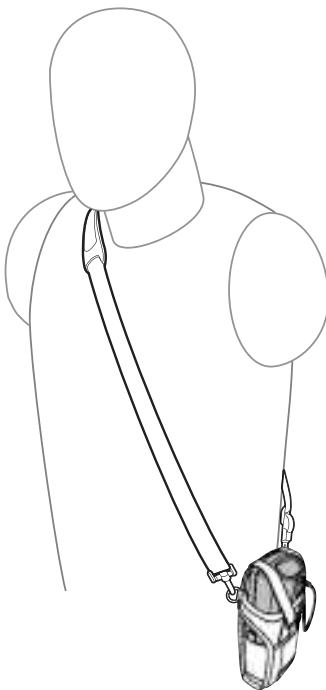

- 5 Lift the strap and insert the MC32N0 into the holster.

- 6 Secure the strap to hold the MC32N0 in place.

Chapter 6

Maintenance and Troubleshooting

This chapter includes instructions on cleaning and storing the device, and provides troubleshooting solutions for potential problems during operation.

Maintaining the MC32N0

For trouble-free service, observe the following tips when using the MC32N0:

- Do not scratch the screen of the MC32N0. When working with the MC32N0, use the supplied stylus or plastic-tipped pens intended for use with a touch-sensitive screen. Never use an actual pen or pencil or other sharp object on the surface of the MC32N0 screen.
- The touch-sensitive screen of the MC32N0 is glass. Do not to drop the MC32N0 or subject it to strong impact.
- Protect the MC32N0 from temperature extremes. Do not leave it on the dashboard of a car on a hot day, and keep it away from heat sources.
- Do not store or use the MC32N0 in any location that is dusty, damp, or wet.
- Use a soft lens cloth to clean the MC32N0. If the surface of the MC32N0 screen becomes soiled, clean it with a soft cloth moistened with a diluted window-cleaning solution.
- Periodically replace the rechargeable battery to ensure maximum battery life and product performance. Battery life depends on individual usage patterns.
- A screen protector is applied to the MC32N0. Zebra recommends using this to minimize wear and tear. Screen protectors enhance the usability and durability of touch screen displays. Benefits include:
 - Protection from scratches and gouges
 - Durable writing and touch surface with tactile feel
 - Abrasion and chemical resistance
 - Glare reduction
 - Keeping the device's screen looking new
 - Quick and easy installation.

Battery Safety Guidelines



Warning: Failure to follow these guidelines may result in fire, explosion, or other hazard.

- The area in which the units are charged should be clear of debris and combustible materials or chemicals. Particular care should be taken where the device is charged in a non commercial environment.
- Follow battery usage, storage, and charging guidelines found in this guide.
- Improper battery use may result in a fire, explosion, or other hazard.
- To charge the mobile device battery, the battery and charger temperatures must be between +32 °F and +104 °F (0 °C and +40 °C)

- Do not use incompatible batteries and chargers. Use of an incompatible battery or charger may present a risk of fire, explosion, leakage, or other hazard. If you have any questions about the compatibility of a battery or a charger, contact Zebra Customer Support Center.
- Do not disassemble or open, crush, bend or deform, puncture, or shred.
- Severe impact from dropping any battery-operated device on a hard surface could cause the battery to overheat.
- Do not short circuit a battery or allow metallic or conductive objects to contact the battery terminals.
- Do not modify or remanufacture, attempt to insert foreign objects into the battery, immerse or expose to water or other liquids, or expose to fire, explosion, or other hazard.
- Do not leave or store the equipment in or near areas that might get very hot, such as in a parked vehicle or near a radiator or other heat source. Do not place battery into a microwave oven or dryer.
- Battery usage by children should be supervised.
- Please follow local regulations to properly dispose of used re-chargeable batteries.
- Do not dispose of batteries in fire.
- Seek medical advice immediately if a battery has been swallowed.
- In the event of a battery leak, do not allow the liquid to come in contact with the skin or eyes. If contact has been made, wash the affected area with large amounts of water and seek medical advice.
- If you suspect damage to your equipment or battery, contact Zebra Customer Support to arrange for inspection.

Cleaning Instructions



Caution:

Always wear eye protection.

Read warning label on compressed air and alcohol product before using.

If you have to use any other solution for medical reasons please contact the Global Customer Support Center for more information.



Warning: Avoid exposing this product to contact with hot oil or other flammable liquids. If such exposure occurs, unplug the device and clean the product immediately in accordance with these guidelines.

Approved Cleanser Active Ingredients

100% of the active ingredients in any cleaner must consist of one or some combination of the following: isopropyl alcohol, bleach/sodium hypochlorite, hydrogen peroxide or mild dish soap.

Harmful Ingredients

The following chemicals are known to damage the plastics on the device and should not come in contact with the device: ammonia solutions, compounds of amines or ammonia; acetone; ketones; ethers; aromatic and chlorinated hydrocarbons; aqueous or alcoholic alkaline solutions; ethanolamine; toluene; trichloroethylene; benzene; carbolic acid and TB-lysoform.

Cleaning Instructions

Do not apply liquid directly to the device. Dampen a soft cloth or use pre-moistened wipes. Do not wrap the device in the cloth or wipe, but gently wipe the unit. Be careful not to let liquid pool around the display window or other places. Allow the unit to air dry before use.

Special Cleaning Notes

Many vinyl gloves contain phthalate additives, which are often not recommended for medical use and are known to be harmful to the housing of the device. The device should not be handled while wearing vinyl gloves containing phthalates, or before hands are washed to remove contaminant residue after gloves are removed. If products

containing any of the harmful ingredients listed above are used prior to handling the device, such as hand sanitizer that contain ethanolamine, hands must be completely dry before handling the device to prevent damage to the plastics.

Cleaning Materials Required

- Alcohol wipes
- Lens tissue
- Cotton-tipped applicators
- Isopropyl alcohol
- Can of compressed air with a tube.

Cleaning Frequency

The cleaning frequency is up to the customer's discretion due to the varied environments in which the mobile devices are used. They may be cleaned as frequently as required, but it is advisable to clean the camera window periodically when used in dirty environments to ensure optimum performance.

Cleaning the MC32N0

Housing

Using the alcohol wipes, wipe the housing including buttons.

Display

The display can be wiped down with the alcohol wipes, but care should be taken not to allow any pooling of liquid around the edges of the display. Immediately dry the display with a soft, non-abrasive cloth to prevent streaking.

Exit Window

Wipe the exit window periodically with a lens tissue or other material suitable for cleaning optical material such as eyeglasses.

Housing

Using the alcohol wipes, wipe the housing including keys and in-between keys.

Display

The display can be wiped down with the alcohol wipes, but care should be taken not to allow any pooling of liquid around the edges of the display. Immediately dry the display with a soft, non-abrasive cloth to prevent streaking.

Camera Window

Wipe the camera window periodically with a lens tissue or other material suitable for cleaning optical material such as eyeglasses.

Connector Cleaning

To clean the connectors:

Procedure:

- 1 Remove the main battery from mobile computer.
- 2 Dip the cotton portion of the cotton-tipped applicator in isopropyl alcohol.

- 3 Rub the cotton portion of the cotton-tipped applicator back-and-forth across the connector. Do not leave any cotton residue on the connector.
- 4 Repeat at least three times.
- 5 Use the cotton-tipped applicator dipped in alcohol to remove any grease and dirt near the connector area.
- 6 Use a dry cotton-tipped applicator and repeat steps 4 through 6.



Caution: Do not point nozzle at yourself and others, ensure the nozzle or tube is away from your face.

- 7 Spray compressed air on the connector area by pointing the tube/nozzle about ½ inch away from the surface.
- 8 Inspect the area for any grease or dirt, repeat if required.

Cleaning Cradle Connectors

To clean the connectors on a cradle:

Procedure:

- 1 Remove the DC power cable from the cradle.
- 2 Dip the cotton portion of the cotton-tipped applicator in isopropyl alcohol.
- 3 Rub the cotton portion of the cotton-tipped applicator along the pins of the connector. Slowly move the applicator back-and-forth from one side of the connector to the other. Do not leave any cotton residue on the connector.
- 4 All sides of the connector should also be rubbed with the cotton-tipped applicator.



Caution: Do not point nozzle at yourself and others, ensure the nozzle or tube is pointed away from your face.

- 5 Spray compressed air in the connector area by pointing the tube/nozzle about ½ inch away from the surface.
- 6 Remove any lint left by the cotton-tipped applicator.
- 7 If grease and other dirt can be found on other areas of the cradle, use a lint-free cloth and alcohol to remove.
- 8 Allow at least 10 to 30 minutes (depending on ambient temperature and humidity) for the alcohol to air dry before applying power to cradle.

If the temperature is low and humidity is high, longer drying time is required. Warm temperature and dry humidity requires less drying time.

Troubleshooting the MC32N0

Table 33: Troubleshooting the MC32N0

Problem	Cause	Solution
Mobile computer does not turn on.	Main battery not charged.	Charge or replace the main battery.
	Main battery not installed properly.	Ensure the battery is installed properly.
	MC32N0 not responding.	Perform a soft reset. If the mobile computer still does not turn on, perform a hard reset. For more information see Resetting the Android Device on page 68 .

Table continued...





Problem	Cause	Solution
Battery did not charge.	Battery failed.	Replace battery. If the mobile computer still does not operate, try a soft reset , then a hard reset. See Resetting the Android Device on page 68 .
	Mobile computer removed from cradle while battery was charging.	Insert mobile computer in cradle and begin charging. The Standard Battery requires up to five hours to recharge fully and the Extended Life Battery requires up to eight hours to recharge fully.
	Extreme battery temperature.	Battery does not charge if ambient temperature is below 32 °F (0 °C) or above 104 °F (40 °C).
Cannot see characters on screen.	Mobile computer not powered on.	Press the Power button.
During data communication, no data was transmitted, or transmitted data was incomplete.	Mobile computer removed from cradle or unplugged from host computer during communication.	Replace the mobile computer in the cradle, or reattach the cable and re-transmit.
	Incorrect cable configuration.	See the system administrator or refer to the <i>MC32N0 Integrator Guide</i> .
Mobile computer does not emit sound.	Volume setting is low or turned off.	Click on the speaker icon to increase the volume.
MC32N0 turns itself off.	MC32N0 is inactive.	The mobile computer turns off after a period of inactivity. This period can be set from 15 seconds to 30 minutes.
	Battery is depleted.	Recharge or replace the battery.
A message appears stating that the mobile computer memory is full.	Too many applications installed on the mobile computer.	Remove user-installed applications on the MC32N0 to recover memory. On Android devices, select  >  Apps > Downloaded . Select the unused programs and touch Uninstall . On WinCE devices, touch Start > Settings > Control Panel > Remove Programs . Select the unused program and touch Remove .
The MC32N0 does not decode when reading bar code.	DataWedge is not enabled.	Ensure that DataWedge is enabled and configured properly. Refer to the <i>MC32N0 Integrator Guide</i> for more information.
	Unreadable bar code.	Ensure the symbol is not defaced.
	Distance between the MC32N0 and bar code is incorrect.	Place the MC32N0 within proper scanning range.
	MC32N0 is not programmed for the bar code type.	Program the MC32N0 to accept the type of bar code being scanned. Refer to the <i>MC32N0 Integrator Guide</i> for DataWedge configuration.

Table continued...

Problem	Cause	Solution
	MC32N0 is not programmed to generate a beep.	If the MC32N0 does not beep on a good decode, set the application to generate a beep on good decode.
MC32N0 cannot find any Bluetooth devices nearby.	Too far from other Bluetooth devices.	Move closer to the other Bluetooth device(s), within a range of 10 meters (32.8 feet).
	The Bluetooth device(s) nearby are not turned on.	Turn on the Bluetooth device(s) to find.
	The Bluetooth device(s) are not in discoverable mode.	Set the Bluetooth device(s) to discoverable mode. If needed, refer to the device's user documentation for help.
Cannot connect to WLAN.	Access Point (AP) does not broadcast country code.	Disable 802.11d feature. On Android devices, touch  > Wi-Fi >  > Advanced . Deselect the Enable 802.11d checkbox. On WinCe devices, Fusion icon, Options > Regulatory option from drop-down list. Deselect Enable 802.11d .
When trying to open File Browser or other applications, the application automatically closes.	The Internal Memory is full.	Connect the MC32N0 to a host computer and delete files from Internal Memory using the host computer.

Chapter 7

Technical Specifications

The following sections provide technical specification for the device.

MC32N0 Technical Specifications

The following table summarizes the MC32N0's intended operating environment and technical hardware specifications.

Table 34: MC32N0 Technical Specifications

Item	Description
Physical Characteristics	
Dimensions	<p>MC32N0-S: 7.49 in L x 3.22 in W x 1.78 in D (190.4 mm L x 81.9 mm W x 45.2 mm D)</p> <p>MC32N0-R: 8.37 in L x 3.22 in W x 1.57 in D (212.6 mm L x 81.9 mm W x 40.0 mm D)</p> <p>MC32N0-G: 7.59 in L x 3.18 in W x 6.5 in D (192.7 mm L x 80.8 mm W x 166.0 mm H)</p>
Weight	<p>MC32N0-R (with standard battery) - 13.1 oz (372 g) MC32N0-S (with standard battery) - 12.88 oz (365 g) MC32N0-G (with extended battery) - 18.0 oz (509 g)</p>
Display	3.0 inch Color (TFT) (320 x 320) display
Touch Panel	Chemically strengthened glass, resistive touch
Backlight	LED backlight
Battery	<p>Standard: Rechargeable Lithium-Ion 2740 mAh minimum (3.7V) Extended Life: Rechargeable Lithium-Ion 4800 mAh minimum (3.7V)</p>
Expansion Slot	User accessible microSD slot. Supports up to 32 GB microSDHC.

Table continued...

Item	Description
Network Connections	Full-speed USB client, full-speed USB host, Bluetooth and WiFi. USB host mode available with appropriate cables only.
Notification	LEDs and audio notifications
Keypad Options	28-key Numeric 38-key Shifted Alpha (calculator-style integrated numeric keypad) 48-key Alpha-Numeric (calculator-style integrated numeric keypad)
Audio	Speaker, microphone, and headset connector (2.5 mm jack).
Performance Characteristics	
CPU	Dual core, OMAP 4 @ 800 MHz (Standard). Dual core, OMAP 4 @ 1 GHz (Premium).
Operating System	Android-based ASOP 4.1.1 (Premium only) or Windows CE 7
Memory	512 MB RAM, 2 GB Flash (Standard). 1 GB RAM, 4 GB Flash (Premium).
Output Power (USB)	USB: 5 VDC @ 500 mA max.
User Environment	
Operating Temperature	-20°C to 50°C (-4°F to 122°F)
Storage Temperature	-40 °C to 70 °C (-40 °F to 158 °F) without battery
Charging Temperature	0 °C to 40 °C (32 °F to 104 °F)
Humidity	10% to 95% RH non-condensing
Drop Specification	Multiple 4 ft./1.2 m drop to concrete across the operating temperature range. Multiple 5 ft./1.5 m drops to concrete at ambient temperature 73 °F/23 °C. Meets and exceeds MIL-STD 810G.
Electrostatic Discharge (ESD)	±20kVdc air discharge, ± 10kVdc direct discharge, ± 10kVdc indirect discharge
Sealing	IP54 per IEC specification.
Wireless LAN Data Communications	
Wireless Local Area Network (WLAN) radio	IEEE® 802.11a/b/g/n with internal antenna
Data Rates Supported	802.11b: 1, 2, 5.5, 11 Mbps 802.11a/g: 6, 9, 12, 18, 24, 36, 48, 54 Mbps 802.11n: 6.5, 13, 19.5, 26, 39, 52, 58.5, 65, 72 Mbps (with SGI) Note that 802.11n data rates may be higher.
Operating Channels	Chan 36 - 165 (5180 – 5825 MHz), Chan 1 - 13 (2412 - 2472 MHz); actual operating channels/frequencies depend on regulatory rules and certification agency.
Security	Security Modes: WPA and WPA2 (Personal or Enterprise)

Table continued...

Item	Description
	<p>Encryption: WEP40/WEP104, TKIP and AES</p> <p>Authentication: TLS; TTLS (CHAP*, MSCHAP, MSCHAPv2, PAP or MD5*); PEAP (TLS*, MSCHAPv2, GTC); LEAP; FAST (TLS*, MSCHAPv2, GTC).</p> <p>Other: Wi-Fi, CCXv4 certified, and supports IPv6 FIPS 140–2 certified (Android), Q4–2014 (WinCE)</p> <p>* WinCE only</p>
Wireless PAN Data	
Bluetooth	Class II, v 2.1 with EDR; integrated antenna.
Sensors (WinCE only)	
Motion Sensor (WinCE only)	3-axis accelerometer that enables motion sensing applications for dynamic screen orientation and power management.
Ambient Light/Proximity Sensor (WinCE only)	Automatically adjusts display brightness and turns off the display during PTT calls.
Data Capture	
Laser scanner	Captures 1D bar codes.
Imager	Captures 1D and 2D bar codes.
Laser Scanner (SE965) Specifications	
Optical Resolution	0.005 in. minimum element width
Roll	Condition: 20 mil Code 39 at 10 in. ± 35° from vertical
Pitch Angle	Condition: 20 mil Code 39 at 10 in. ± 65° from normal
Skew Tolerance	Condition: 20 mil Code 39 at 10 in. ± 40° from normal
Ambient Light	<p>Tolerant to typical artificial indoor and natural outdoor (direct sunlight) lighting conditions.</p> <p>Fluorescent, Incandescent, Mercury Vapor, Sodium Vapor, LED: 450 ft. Candles (4,844 Lux)</p> <p>Sunlight: 10,000 Ft Candles (107,640 Lux)</p> <p>Note: LED lighting with high AC ripple content can impact scanning performance.</p>
Scan Repetition Rate	104 (± 14) scans/sec (bidirectional)
Scan Angle	Wide (Default): 47° (typical) Medium: 35° (typical)

Table continued...

Item	Description
	Narrow: 10° (typical)
2D Imager Engine (SE4750) Specifications	
Field of View	Horizontal - 48.0° Vertical - 36.7°
Image Resolution	1280 horizontal X 960 vertical pixels
Roll	360°
Pitch Angle	+/- 60° from normal
Skew Tolerance	+/- 60° from normal
Ambient Light	Sunlight: 10,000 ft. candles (107,639 lux)
Focal Distance	From front of engine: 17.7 cm (7.0 in.)
Laser Aiming Element	Visible Laser Diode (VLD): 655 nm +/- 10 nm Central Dot Optical Power: 0.6 mW (typical) Pattern Angle: 48.0° horizontal, 38.0° vertical
Illumination System	LEDs: Warm white LED Pattern Angle: 80° at 505 intensity
Supported Symbologies	
1D	Chinese 2 of 5, Codabar, Code 11, Code 128, Code 39, Code 93, Discrete 2 of 5, EAN-8, EAN-13, GS1 DataBar, GS1 DataBar Expanded, GS1 DataBar Limited, Interleaved 2 of 5, Korean 2 of 5, MSI, TLC 39, Matrix 2 of 5, Trioptic, UPCA, UPCE, UPCE1, Web Code.
2D	Australian Postal, Aztec, Canadian Postal, Composite AB, Composite C, Data Matrix, Dutch Postal, Japan Postal, Maxicode, Micro PDF, Micro QR, PDF, QR Code, UK Postal, US Planet, US Postnet, US4State, US4State FICS.

Chapter 8

MC32N0 Keypads

Introduction

The MC32N0 offers three types of keypad configurations: 28 key, 38 key and 48 key.

MC32N0 28-Key Keypad

The 28-key keypad contains a Power button, application keys, scroll keys and function keys. The keypad is color-coded to indicate the alternate function key (blue) values and the alternate ALPHA key (orange) values. Note that keypad functions can be changed by an application so the mobile computer keypad may not function as described. See the tables below for key and button descriptions and keypad alternate functions.

Figure 152: 28-Key Keypad Android Configuration



Figure 153: 28-Key Keypad WinCE Configuration



Table 35: 28-Key Keypad Descriptions





Key	Description
	Powers the mobile computer screen on and off (resume and suspend).
	On WinCE devices, programmable application function key by default.
	On WinCE devices, programmable application function key by default.
	On Android device, displays the previous screen. Closes the on-screen keyboard if open.
	On Android device, opens a menu with items that affect the current screen or application.
	Used in scanning applications, press to scan a bar code. This key has the same function as activating the side mounted scan buttons.

Table continued...





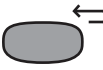

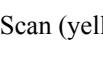

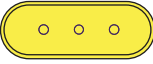

Key	Description
	
<p>Scroll Up and Down</p> 	<p>Moves up and down from one item to another. Increases/decreases specified values.</p> <p>Increases and decreases volume when the blue FUNC key is activated and the up and down arrow keys are pressed.</p>
<p>Scroll Left and Right</p> 	<p>Moves left and right from one item to another. Increases/decreases specified values.</p> <p>Produces a TAB when the blue FUNC key is activated and the right arrow key is pressed.</p>
<p>ESC</p>	<p>Produces the ESC function by default.</p>
<p>CTRL</p> 	<p>Press and release the CTRL key to activate the keypad alternate CTRL functions.</p> <p>The  icon appears on the taskbar on WinCE devices or the  icon appears in the Status bar on Android devices. Press and release the CTRL key again to return to the default keypad functions. Press and release the blue FUNC key and then the CTRL key to activate the ALT functions. The  icon appears on the taskbar on WinCE devices or the  icon appears in the Status bar for Android devices. Press and release the CTRL key two times to return to the default keypad functions.</p>
<p>Numeric/Alpha/Special Function</p> 	<p>Numeric, alpha or special function keys. Numeric by default. Produces a special function when the blue FUNC key is activated. Produces alpha values when the orange ALPHA key is activated. In Alpha state, produces the lower case alphabetic characters on the key. Each key press produces the next alphabetic character in sequence. For example, press and release the ALPHA key and then press the 4 key once to produce the letter 'g'; press and release the ALPHA key and then press the 4 key three times to produce the letter 'i'. When the SHIFT key is pressed in Alpha state, the upper case alphabetic characters on the key are produced. For example, press and release the ALPHA key, press and hold the SHIFT key and then press the 4 key once to produce the letter 'G'; press and release the ALPHA key, press and hold the SHIFT key and then press the 4 key three times to produce the letter 'I'.</p>
<p>Period/Decimal Point</p> 	<p>Produces a period for alpha entries and a decimal point for numeric entries by default. Increases brightness when the blue FUNC key is activated.</p>
<p>Enter</p> 	<p>Executes a selected item or function.</p>
<p>BKSP</p> 	<p>Backspace function by default. Decreases brightness when the blue FUNC key is activated.</p>

Table continued...





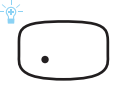





Key	Description
SPACE 	Space function by default.
Shift 	Press and release the SHIFT key to activate the keypad alternate SHIFT functions. The  icon appears on the taskbar on WinCE devices and the  icon appears on the Status bar on Android devices. Press and release the SHIFT key again to return to the default keypad functions.
ALPHA 	Press the orange ALPHA key to access the alternate ALPHA characters (shown on the keypad in orange). The  icon appears on the taskbar on WinCE devices and the  icon appears on the Status bar on Android devices. Press and release the orange ALPHA key again to return to the default keypad functions.
FUNC 	Press and release the blue FUNC key to activate the keypad alternate functions (shown on the keypad in blue). The  icon appears on the taskbar on WinCE devices or the  icon appears on the Status bar on Android devices. Press and release the blue FUNC key again to return to the default keypad functions.
Display backlight	On WinCE device, toggles the display backlight on and off.
Home 	On Android device, displays the Home screen with a single press. Displays recently used applications when held for a short period of time.

Table 36: 28-key Keypad Input Modes

Key	Numeric State		Orange Key (Alpha Lowercase State)				Orange Key + Shift Key (Alpha Uppercase State)			
		SHIFT + Key	1st Press	2nd Press	3rd Press	4th Press	1st Press	2nd Press	3rd Press	4th Press
1	1	!	*							
2	2	@	a	b	c		A	B	C	
3	3	#	d	e	f		D	E	F	
4	4	\$	g	h	i		G	H	I	
5	5	%	j	k	l		J	K	L	
6	6	^	m	n	o		M	N	O	
7	7	&	p	q	r	s	P	Q	R	S
8	8	*	t	u	v		T	U	V	
9	9	(w	x	y	z	W	X	Y	Z
0	0)	0				0			
.	.	>	.				.			

Table continued...

Key	Numeric State	Orange Key (Alpha Lowercase State)				Orange Key + Shift Key (Alpha Uppercase State)			
	SHIFT + Key	1st Press	2nd Press	3rd Press	4th Press	1st Press	2nd Press	3rd Press	4th Press



Note: An application can change the key functions. The keypad may not function exactly as described.

MC32N0 38-Key Keypad

The 38-key keypad contains a Power button, application keys, scroll keys and function keys. The keypad is color-coded to indicate the alternate function key (blue) values. Note that keypad functions can be changed by an application so the mobile computer keypad may not function as described. The tables below provide key and button descriptions and keypad alternate functions.

Figure 154: 38-Key Keypad Android Configuration

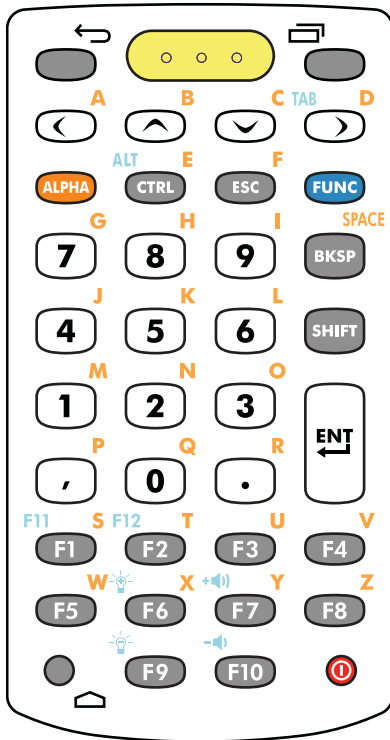

Figure 155: 38-Key Keypad WinCE Configuration

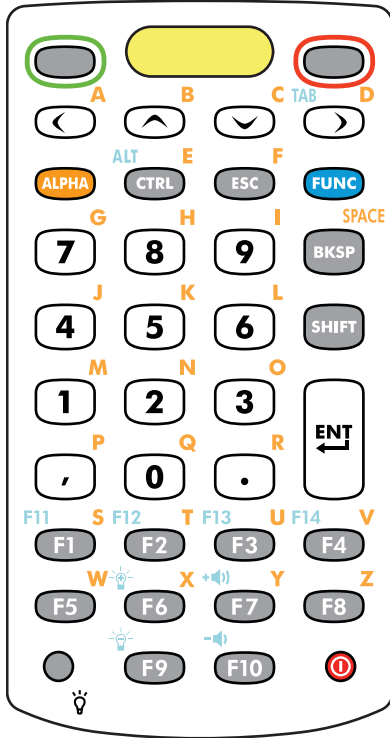

Table 37: 38-Key Keypad Descriptions





Key	Description
	Powers the mobile computer screen on and off (resume and suspend).
	On WinCE devices, programmable application function key by default.
	On WinCE devices, programmable application function key by default.
	On Android device, displays the previous screen. Closes the on-screen keyboard if open.
	On Android device, opens a menu with items that affect the current screen or application.
	Used in scanning applications, press to scan a bar code. This key has the same function as activating the side mounted scan buttons.

Table continued...







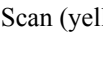



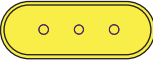





Key	Description
	
Scroll Up and Down  	Moves up and down from one item to another. Increases/decreases specified values. Increases and decreases volume when the blue FUNC key is activated and the up and down arrow keys are pressed.
Scroll Left and Right  	Moves left and right from one item to another. Increases/decreases specified values. Produces a TAB when the blue FUNC key is activated and the right arrow key is pressed.
ALPHA 	Press the orange ALPHA key to access the alternate ALPHA characters (shown on the keypad in orange). The ALP icon appears on the taskbar on WinCE devices or the  icon appears on the Status bar on Android devices. Press and release the orange ALPHA key again to return to the default keypad functions.
CTRL 	Press and release the CTRL key to activate the keypad alternate CTRL functions. The  icon appears on the taskbar on WinCE devices or the C icon appears on the Status bar on Android devices. Press and release the CTRL key again to return to the default keypad functions. Press and release the blue FUNC key and then the CTRL key to activate the ALT functions. The  icon appears on the taskbar on WinCE devices or the A icon appears on the Status bar on Android devices. Press and release the CTRL key two times to return to the default keypad functions.
ESC 	Produces the escape function.
FUNC 	Press and release the blue FUNC key to activate the keypad alternate functions (shown on the keypad in blue). The  icon appears on the taskbar on WinCE devices or the  icon appears on the Status bar on Android devices. Press and release the blue FUNC key again to return to the default keypad functions.
Numeric/Alpha/Special Function 	Press for the default numeric value. Produces alpha values when the orange ALPHA key is activated.
BKSP 	Backspace function by default. Decreases brightness when the blue FUNC key is activated.

Table continued...





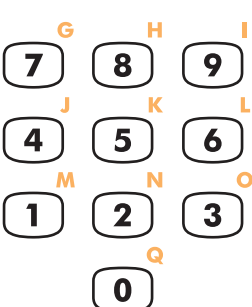



Key	Description
Shift 	Press and release the SHIFT key to activate the keypad alternate SHIFT functions. The  icon appears on the taskbar on WinCE devices and the  icon appears on the Status bar on Android devices. Press and release the SHIFT key again to return to the default keypad functions.
Enter 	Executes a selected item or function.
Period 	Produces a period for alpha entries and a decimal point for numeric entries.
Comma 	Produces a comma by default.
Special Function/Alpha 	Special function by default or when the blue FUNC key is activated.
Display backlight 	On WinCE device, toggles the display backlight on and off.
Home 	On Android devices, displays the Home screen with a single press. Displays recently used applications when held for a short period of time.

Table 38: 38-key Keypad Input Modes

Key	Normal	SHIFT + Key	Orange + Key	Orange + SHIFT + Key	Blue + Key
Right Arrow			a	A	
Up Arrow			b	B	
Down Arrow			c	C	
Left Arrow			d	D	Tab
CTRL			e	E	Ctrl
ESC			f	F	

Table continued...

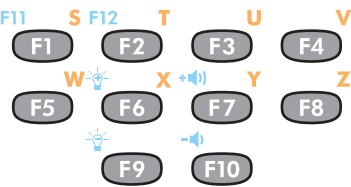
Key	Normal	SHIFT + Key	Orange + Key	Orange + SHIFT + Key	Blue + Key
7	7	&	g	G	-
8	8	*	h	H	=
9	9	(I	I	/
BKSP	Backspace	Backspace	Space	Space	Backspace
4	4	\$	j	J	[
5	5	%	k	K]
6	6	^	l	L	;
1	1	!	m	M	'
2	2	@	n	N	'
3	3	#	o	O	\
,	,	<	p	P	,
0	0)	q	Q	0
.	.	>	r	R	-
F1			s	S	F11
F2			t	T	F12
F3			u	U	F13
F4			v	V	F14
F5			w	W	
F6			x	X	Increase Brightness
F7			y	Y	Increase Volume
F8			z	Z	
F9					Decrease Brightness
F10			*		Decrease Volume



Note: An application can change the key functions. The keypad may not function exactly as described.

MC32N0 48-Key Keypad

The 48-key keypad contains a Power button, application keys, scroll keys and function keys. The keypad is color-coded to indicate the alternate function key (blue) values. Note, that keypad functions can be changed by an application so the mobile computer keypad may not function as described. The tables below provide key and button descriptions and keypad alternate functions.

Figure 156: 48-Key Keypad Android Configuration

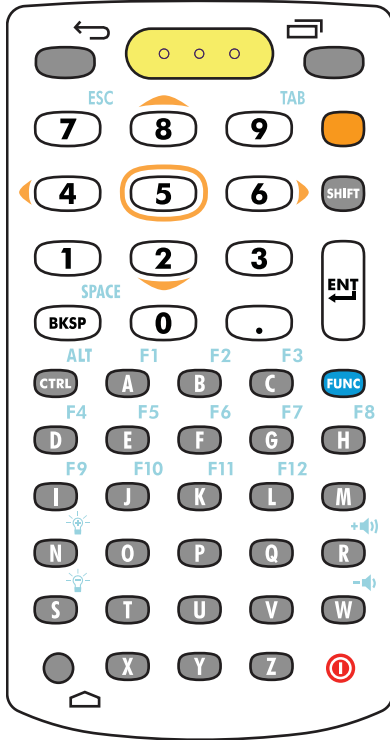

Figure 157: 48-Key Keypad WinCE Configurations

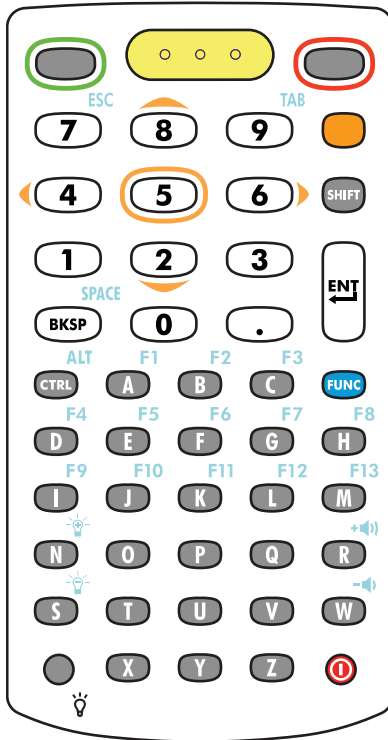

Table 39: 48-Key Keypad Descriptions





Key	Description
Power (red) 	Powers the mobile computer screen on and off (resume and suspend).
Green Circle 	On WinCE devices, programmable application function key by default.
Red Circle 	On WinCE devices, programmable application function key by default.
Back 	On Android device, displays the previous screen. Closes the on-screen keyboard if open.
Menu 	On Android device, opens a menu with items that affect the current screen or application.
Scan (yellow)	Used in scanning applications, press to scan a bar code. This key has the same function as activating the side mounted scan buttons.

Table continued...





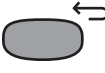





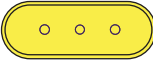

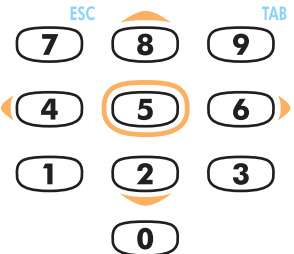

Key	Description
	
<p>Orange</p> 	<p>Press the orange key to access the alternate navigation and selection functions. The ALP icon appears in the taskbar on WinCE devices and the  icon appears on the Status bar on Android devices. Press and release the orange key again to return to the default keypad functions.</p>
<p>Numeric/Scroll/Select</p> 	<p>Numeric, scroll, select keys. Numeric by default. With the orange key activated, the 2, 4, 6, and 8 keys produce scroll functions and the 5 key produces a select function. With the FUNC key activated, 7 produces the ESC function and 9 produces the TAB function.</p>
<p>Shift</p> 	<p>Press and release the SHIFT key to momentarily activate the keypad alternate SHIFT functions. The  icon appears on the taskbar on WinCE devices and the  icon appears on the Status bar on Android devices. Press and release the SHIFT key again to return to the default keypad functions. Press and release the SHIFT key a second time to lock the keypad into the Shift-Lock mode. The  icon appears in the taskbar on WinCE devices and the  icon appears on the Status bar on Android devices. Press and release the SHIFT key again to return to the default keypad functions.</p>
<p>Enter</p> 	<p>Executes a selected item or function.</p>
<p>BKSP/SPACE</p> 	<p>BKSP, backspace function by default. Produces the SPACE function when the blue FUNC key is activated.</p>
<p>Period</p>	<p>Produces a period for alpha entries and a decimal point for numeric entries.</p>
<p>CTRL</p> 	<p>Press and release the CTRL key to activate the keypad alternate CTRL functions. The  icon appears in the taskbar on WinCE devices or the  icon appears on the Status bar on Android devices. Press and release the CTRL key again to return to the default keypad functions. Press and release the blue FUNC key and then the CTRL key to activate the ALT functions. The  icon appears on the taskbar on WinCE devices or the  icon appears on the Status bar on Android devices. Press and release the CTRL key two times to return to the default keypad functions.</p>
<p>Alpha/Special Function</p>	<p>Alpha by default. Special function by default when the blue FUNC key is activated.</p>

Table continued...

Key	Description
FUNC 	Press and release the blue FUNC function key to activate the keypad alternate functions (shown on the keypad in blue). The icon appears on the taskbar on WinCE devices and the icon appears on the Status bar on Android devices. Press and release the blue FUNC function key again to return to the default keypad functions.
Display Backlight 	On WinCe devices, toggles the display backlight on and off.
Home 	On Android devices, displays the Home screen with a single press. Displays recently used applications when held for a short period of time.

Table 40: 48-key Keypad Input Modes

Key	Normal	SHIFT + Key	Blue + Key
A	a	A	F1
B	b	B	F2
C	c	C	F3
D	d	D	F4
E	e	E	F5
F	f	F	F6
G	g	G	F7
H	h	H	F8
I	I	I	F9
J	j	J	F10
K	k	K	F11
L	l	L	F12
M	m	M	
N	n	N	Increase Brightness

Table continued...

Key	Normal	SHIFT + Key	Blue + Key
O	o	O	-
P	p	P	=
Q	q	Q	/
R	r	R	Increase Volume
S	s	S	Decrease Brightness
T	t	T	[
U	u	U]
V	v	V	;
W	w	W	Decrease Volume
X	x	X	'
Y	y	Y	`
Z	z	Z	*
BKSP	Backspace	Delete	Space
1	1	!	
2	2	@	
3	3	#	
4	4	\$	
5	5	%	
6	6	^	
7	7	&	
8	8	*	
9	9	(
0	0)	



Note: An application can change the key functions. The keypad may not function exactly as described.

Index

A

AC line cord [128](#)
 adaptive frequency hopping [79](#), [102](#)
 albums [56](#)
 android version [14](#)
 application shortcuts [47](#)
 applock administrator [52](#)
 approved cleanser [152](#)

B

battery
 charging [31](#)
 management [37](#), [39](#)
 battery adapter [127](#)
 bluetooth [78](#)
 Bluetooth
 PIN [79](#), [102](#)
 security [79](#), [102](#)
 browser [50](#)
 build number [14](#)

C

calculator [51](#)
 calendar [51](#)
 charge LED [19](#), [23](#), [25](#)
 charge only cable [128](#)
 cleaning [152](#)
 cleaning instructions [152](#)
 clock [51](#)
 configuration [13](#), [14](#)
 contacts [51](#)
 cradle
 connector cleaning [154](#)
 creating folders [48](#)

D

datawedge [51](#), [124](#), [125](#)
 decode mode [117](#)
 default notifications [71](#)
 diagnostics [51](#)
 display
 cleaning [153](#)
 downloads [51](#)
 DWDemo [51](#)

E

email [51](#)
 Ethernet connection [137](#)

F

file browser [51](#), [53](#)

four slot charge only cradle [127](#)
 four slot spare battery charger [127](#)
 four-slot Ethernet cradle base [127](#)

G

gallery [51](#)

H

harmful ingredients [152](#)

I

imager [13](#), [14](#)

K

keyboard [50](#)

L

laser scanner [13](#), [117](#)
 laser scanning [117](#)

M

memory [13](#), [14](#)
 microphone [23](#), [25](#)
 multiuser administrator [52](#)

N

naming folders [48](#)

O

operating system [13](#), [14](#)

P

picklist mode [117](#)
 power button [20](#)
 power supply [127](#), [128](#)

R

radios [13](#), [14](#)
 resetting [68](#)
 RS232 charge cable [128](#)
 RS507 scanning [121](#)

S

scan angle [118](#)

scan button [19](#)
scan LED [19](#), [22](#), [25](#)
scanning range [118](#)
screen lock sounds [71](#)
screen timeout [70](#)
secure storage administrator [52](#)
serial number [14](#)
service information [17](#)
settings [52](#)
single slot cradle RS323 cable [128](#)
single slot cradle USB cable [129](#)
single-slot serial/USB cradle [127](#)
soft reset [68](#)
sound recordet [52](#)
stattaskus bar [86](#)
status bar [44](#)
system sounds [71](#)

T

trigger [20](#)

U

universal battery charge [127](#)
universal battery charger adaprer [127](#)
universal battery charger adapter [142](#)
USB client charge cable [128](#)

V

volume [71](#)

Z

Zebra printer cable [128](#)