



Operator Manual

For printer model:

CG4 Series



CG408DT
CG412DT
Direct Thermal Type



CG408TT
CG412TT
Thermal Transfer Type

PN: 9001218C

Read this Operator Manual before using this product.
Keep this document available for future reference.

SATO America, Inc.

10350A Nations Ford Road
Charlotte, NC 28273

Main Phone: (704) 644.1650

Technical Support: (704) 644.1660

Technical Support Fax: (704) 644.1661

E-Mail: satosales@satoamerica.com

techsupport@satoamerica.com

www.satoamerica.com

Copyright 2011 SATO America, Inc. All rights reserved

Caution

(1) Reproduction in any manner of all or part of this document is prohibited.

(2) The contents of this document may be changed without prior notice.

(3) Great care has been taken in the preparation of this document. However, if, for any reason, if any problems, mistakes, or omissions are found, please contact your SATO reseller or technical support center.

FCC statement



The printer complies with the requirements in Part 15 of FCC Rules for a Class B Computing Device. Operating the printer in a residential area may cause unacceptable interference to radio and TV reception. If the interference is unacceptable, you can reposition the equipment, which may improve reception.

Safety Precautions

Please read the following information carefully before installing and using the printer.

Pictographic Symbols

This instruction manual and the printer labels use a variety of pictographic symbols to facilitate safe and correct use of the printer and to prevent injury to others and property damage. The symbols and meanings for them are given below. Be sure to understand these symbols well before reading the main text.

 Warning	Ignoring the instructions marked by this symbol and erroneously operating the printer could result in death or serious injury.
 Caution	Ignoring the instructions marked by this symbol and erroneously operating the printer could result in injury or property damage.

Example Pictographs





The  pictograph means "Caution is required." A specific warning symbol is contained inside this pictograph (The symbol at left is for electric shock).





















The  pictograph means "Should not be done." What is specifically prohibited is contained in or near the pictograph (The symbol at left means "Disassembly prohibited").



The  pictograph means "Must be done." What is specifically to be done is contained in the pictograph (The symbol at left means "Unplug the power cord from the outlet").

 Warning		
<p>Do not set on an unstable area</p> <ul style="list-style-type: none"> Do not set on an unstable area, such as a wobbly table or slanted area or an area subject to strong vibration. If the printer falls off or topples over, it could injure someone. <p>Do not place containers full of water or other liquid on the printer</p> <ul style="list-style-type: none"> Do not place flower vases, cups, or other containers holding liquids, such as water or chemicals, or small metal objects near the printer. If they are spilled and get inside the printer, immediately turn off the power switch, unplug the power cord from the outlet, and contact your SATO reseller or technical support center. Using the printer in this condition could cause a fire or electric shock. <p>Do not put objects inside the printer</p> <ul style="list-style-type: none"> Do not insert or drop in metal or burnable objects inside the printer's openings (cable outlets, etc.). If foreign objects do get inside the printer, immediately turn off the power switch, unplug the power cord from the outlet, and contact your SATO reseller or technical support center. Using the printer in this condition could cause a fire or electric shock. 	<p>Do not use other than the specified voltage</p> <ul style="list-style-type: none"> Do not use other than the specified voltage. Doing so could result in fire or electric shock. <p>Always ground the connections</p> <ul style="list-style-type: none"> Always connect the printer's ground wire to a ground. Not grounding the ground wire could result in electric shock. <p>Handling of the power cord</p> <ul style="list-style-type: none"> Do not damage, break, or modify the power cord. Also, do not place heavy objects on the power cord, heat it, or pull it because doing so could damage the power cord and cause a fire or electric shock. If the power cord becomes damaged (core is exposed, wires broken, etc.), contact your SATO reseller or technical support center. Using the power cord in this condition could cause a fire or electric shock. Do not modify, excessively bend, twist, or pull the power cord. Using the power cord in such a condition could cause a fire or electric shock. 	<p>When the printer has been dropped or broken</p> <ul style="list-style-type: none"> If the printer is dropped or broken, immediately turn off the power switch, unplug the power cord from the outlet, and contact your SATO reseller or technical support center. Using the printer in this condition could cause a fire or electric shock. <p>Do not use the printer when something is abnormal about it</p> <ul style="list-style-type: none"> Continuing to use the printer in the event something is abnormal about it, such as smoke or unusual smells coming from it, could result in fire or electric shock. Immediately turn off the power switch, unplug the power cord from the outlet, and contact your SATO reseller or technical support center for repairs. It is dangerous for the customer to try to repair it, so absolutely do not attempt repairs on your own. <p>Do not disassemble the printer</p> <ul style="list-style-type: none"> Do not disassemble or modify the printer. Doing so could result in fire or electric shock. Contact your SATO reseller or technical support center to conduct internal inspections, adjustments, and repairs.

 Warning		
<p>Regarding the cutter</p>  <ul style="list-style-type: none"> Do not touch the cutter with your hands or do not put something into the cutter. Doing so could result in an injury. 	<p>Using the head cleaning fluid</p>   <ul style="list-style-type: none"> Use of flame or heat around the head cleaning fluid is prohibited. Absolutely do not heat it or subject it to flames. Keep the fluid out of reach of children to prevent them from accidentally drinking it. If the fluid is drunk, immediately consult with a physician. 	

 Caution		
<p>Do not place in areas with high humidity</p>  <ul style="list-style-type: none"> Do not place the printer in areas with high humidity or where condensation forms. If condensation forms, immediately turn off the power switch and do not use the printer until it dries. Using the printer while condensation is on it could result in electric shock. <p>Carrying the Printer</p>    <ul style="list-style-type: none"> When moving the printer, always unplug the power cord from the outlet and check to make sure all external wires are disconnected before moving it. Moving the printer with the wires still connected could damage the cords or connecting wires and result in a fire or electrical shock. Do not carry the printer with paper loaded in it. The paper could fall out and cause an injury. When setting the printer on the floor or a stand, make sure not to get your fingers or hands pinched under the printer feet. 	<p>Power supply</p>  <ul style="list-style-type: none"> Do not operate the power switch or plug in/unplug the power cord with wet hands. Doing so could result in electric shock. <p>Power cord</p>    <ul style="list-style-type: none"> Keep the power cord away from hot devices. Getting the power cord close to hot devices could cause the cord's covering to melt and cause a fire or electrical shock. When unplugging the power cord from the outlet, be sure to hold it by the plug. Pulling it by the cord could expose or break the core wires and cause a fire or electric shock. The power cord set that comes with the printer is especially made for this printer. Do not use it with any other electrical devices. <p>Top cover</p>  <ul style="list-style-type: none"> Be careful not to get your fingers pinched when opening or closing the top cover. Also be careful the top cover does not slip off and drop. 	<p>Print head</p>   <ul style="list-style-type: none"> The print head is hot after printing. Be careful not to get burned when replacing paper or cleaning immediately after printing. Touching the edge of the print head immediately after printing could result in injury. Use caution when replacing the label or cleaning the print head. You should not replace the print head without having received the proper training. <p>Loading paper</p>  <ul style="list-style-type: none"> When loading roll paper, be careful not to get your fingers pinched between the paper roll and the supply unit. <p>When not using the printer for a long time</p>  <ul style="list-style-type: none"> When not using the printer for a long time, unplug the power cord from the outlet to maintain safety. <p>During maintenance and cleaning</p>  <ul style="list-style-type: none"> When maintaining and cleaning the printer, unplug the power cord from the outlet to maintain safety.

Precautions for Installation and Handling

Printer operation can be affected by the printer environment.

Refer to the following instructions for installation and handling of CG4 Series printer.

Select a Safe Location

Place the printer on a surface that is flat and level.

If the surface is not flat and level, this may result in poor print quality. This may also cause malfunction and shorten the life span of the printer.

Do not place the printer on a location that produces vibration.

Giving serious vibration or shock to the printer may cause malfunction and shorten the life span of the printer.

Keep the printer out of high temperature and humidity.

Avoid locations subject to extreme or rapid changes in temperature or humidity.

Do not place the printer in a location subject to water or oil.

Do not place the printer in a location where it will be splashed with water or oil. Water or oil entering inside the printer may cause a fire, electric shock, or malfunction.

Avoid dust.

Dust build up may result in poor print quality.

Keep out of direct sunlight.

This printer has a built-in optical sensor. Exposure to direct sunlight will make the sensor less responsive and may cause the label to be sensed incorrectly. Close the top cover when printing.

Power Supply

This printer requires an AC power supply.

Be sure to connect the printer to an AC power supply via the supplied AC adapter.

Connect the power cord to a grounded power outlet.

Make sure that the printer is plugged into a grounded power outlet.

Provide a stable source of electricity to the printer.

When using the printer, do not share its power outlet with other electrical devices that could result in power fluctuations and performance issues with your printer.

Table of Contents

Introduction	1 - 1
1.1 Features of the Printer.....	1 - 1
1.2 Unpacking	1 - 2
1.3 Parts Identification.....	1 - 3
Installation	2 - 1
2.1 Site Location	2 - 2
2.2 Media Selection.....	2 - 2
2.3 Loading Labels.....	2 - 3
2.4 Loading the Carbon Ribbon (For CG408TT, CG412TT only)	2 - 7
2.5 Connections	2 - 10
Operation and Configuration	3 - 1
3.1 Operator Panel.....	3 - 2
3.2 Operating Modes.....	3 - 3
3.3 User Test Print Mode	3 - 4
3.4 Factory Test Print Mode.....	3 - 8
3.5 Operation Setting Mode	3 - 11
3.6 Program Download Mode.....	3 - 13
3.7 Font Download Mode	3 - 15
3.8 Default Setting Mode.....	3 - 16
3.9 HEX Dump Mode	3 - 17
3.10 Error Occurrence While Downloading.....	3 - 17
3.11 Printer Configurations Setting	3 - 18
Troubleshooting.....	4 - 1
4.1 Error signal troubleshooting	4 - 2
4.2 Troubleshooting table.....	4 - 4
4.3 Interface troubleshooting.....	4 - 6
4.4 Test print troubleshooting.....	4 - 7
Cleaning and Maintenance.....	5 - 1
5.1 Cleaning The Print Head, Platen and Rollers.....	5 - 2
5.2 How To Clean The Printer (Cleaning Kit).....	5 - 2
5.3 How To Clean The Printer (Cleaning Sheet).....	5 - 3
5.4 Easy Replacement of Parts.....	5 - 4
5.5 Adjusting Print Quality	5 - 7
General Specifications	6 - 1
6.1 Printer Basic Specifications.....	6 - 1
6.2 Optional Accessories Specifications	6 - 7
Interface Specifications.....	7 - 1
7.1 Interface types.....	7 - 1
7.2 RS232C Serial Interface.....	7 - 2
7.3 IEEE 1284 Parallel Interface	7 - 6
7.4 Universal Serial Bus (USB) Interface	7 - 9
7.5 Local Area Network (LAN) Ethernet.....	7 - 11

Appendix	8 - 1
8.1 Optional Accessories - Cutter.....	8 - 2
8.2 Optional Accessories - Dispenser	8 - 3
8.3 Positions of sensors and options.....	8 - 5
8.4 Operation Mode Selection.....	8 - 6
8.5 Base Reference Point	8 - 7
8.6 Offset position Adjustment	8 - 9
8.7 Paper End	8 - 10
8.8 Ribbon End	8 - 11
SATO Group of Companies	9 - 1
SATO Group of Companies	9 - 2

1

INTRODUCTION

Thank you for your investment in this SATO printer product.

This Operators Manual contains the basic information about the installation, setup, configuration, operation and maintenance of the printer.

A total of eight topics are covered herein, and they are organized as follows:

- Section 1: Introduction
- Section 2: Installation
- Section 3: Operation and Configuration
- Section 4: Troubleshooting
- Section 5: Cleaning and Maintenance
- Section 6: General Specifications
- Section 7: Interface Specifications
- Section 8: Appendix

It is recommended that you read carefully and become familiar with each section before installing and maintaining the printer. Refer to the **Table Of Contents** at the front of this manual to search for the relevant information needed. All page numbers in this manual consist of a section number followed by the page number within the stated section.

This section assists you in unpacking the printer from the shipping container. You will also be guided through a familiarization tour of the main parts and controls.

The following information is provided herein:

- Features of the printer
- Unpacking
- Parts Identification

1.1 FEATURES OF THE PRINTER

The CG4 Series is 4 inch Compact Desktop printer (Thermal Transfer or Direct Thermal). With a 32-bit RISC CPU, 4 ips print speed, and 4MB Flash Memory, the CG4 Series is an economical printer with numerous features making it suitable for a wide range of applications. The key features of the CG4 Series are:

- High Print Resolution with crisp printing quality (203dpi or 305dpi)
- Multiple Interface
- Cutter and Dispenser Printer Options
- Linerless Label Support
- Easy Media Loading
- Standalone Capability using Keypad
- Tool-less changing of print head and platen roller for easier maintenance
- Codepage Support and Emulations
- Safety Top Cover Latch
- Distinctive Chassis color

1.2 UNPACKING

When unpacking the printer, take note of the following:

1. The box should stay right-side up.
Lift the printer out of the box carefully.
2. Remove all the packaging from the printer.
3. Remove the accessory items from their protective containers.
4. Set the printer on a solid, flat surface. Inspect the shipping container and printer for any sign of damage that may have occurred during shipping. Please note that SATO shall hold no liability of any damage of any kind sustained during shipping of the product.

Notes

- If the printer has been stored in the cold, allow it to reach room temperature before turning it on.
- Please do not discard the original packaging box and cushioning material after installing the printer. They may be needed in future, if the printer needs to be shipped for repairs.

1.2.1 Included Accessories

After unpacking the printer, verify that you have the following materials:

User Documents
(Quick Guide, Warranty, etc)



Power plug*

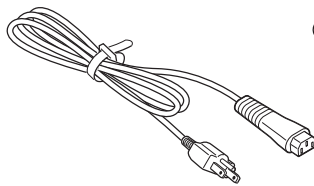

AC adapter

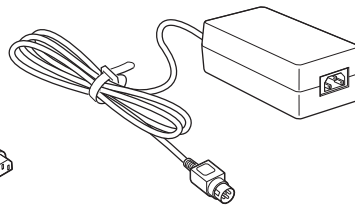

* The shape of the power plug may vary, depending on the location where it was purchased.

1.3 PARTS IDENTIFICATION

Front view



① **Operator panel**

It consists of two contact buttons and two LED indicators (green and red).

② **Top cover**

Open this cover to load the media and ribbon.

③ **Cover open/close latch**

Pull these latches on both sides of the printer forward to open the Top cover of the printer.

④ **Media ejection slot**

Opening for media output.

⑤ **POWER button**

Press this button to turn the power on or off.

⑥ **FEED/LINE button**

Press this button to select the printer status (online/ offline) or to feed the media.

⑦ **ERROR LED indicator**

The LED lights or blinks red when an error is detected in the printer.

During printer configuration setting, the ERROR indicator responds in conjunction with the ON LINE (POWER) indicator to show the modes of the printer.

⑧ **ON LINE (POWER) LED indicator**

The LED lights green when the printer is online and blinks green when the printer is offline.

During printer configuration setting, the ON LINE (POWER) indicator responds in conjunction with the ERROR indicator to show the modes of the printer.

1.3 PARTS IDENTIFICATION (cont'd)

Back view

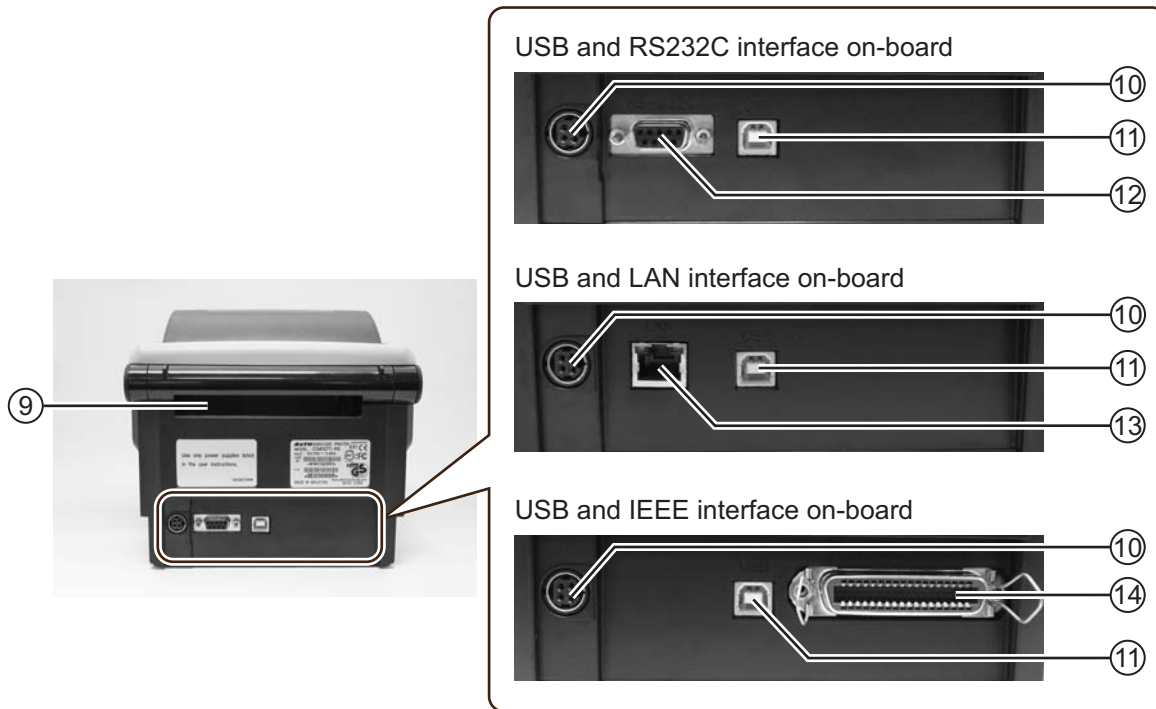

⑨ **Media inlet**

An opening for Fan-folded media or media from unwinder to feed in to the printer.

⑩ **DC input power terminal**

Supplies power to the printer by inserting the power cable via the AC adapter.

⑪ **USB interface terminal**

To connect printer to the host computer using the USB interface.

⑫ **RS-232C interface terminal**

To connect printer to the host computer using RS-232C interface.

Or, to connect the optional Keypad, Scanner or Smart keyboard to the printer.

⑬ **LAN interface terminal**

To connect printer to the host computer using LAN interface.

⑭ **IEEE interface terminal**

To connect printer to the host computer using IEEE interface.

1.2 PARTS IDENTIFICATION (cont'd)

Internal view when Top cover is opened

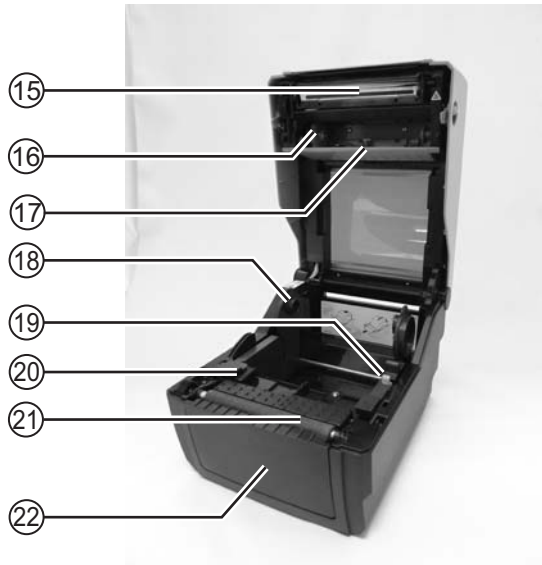

CG408TT/ CG412TT

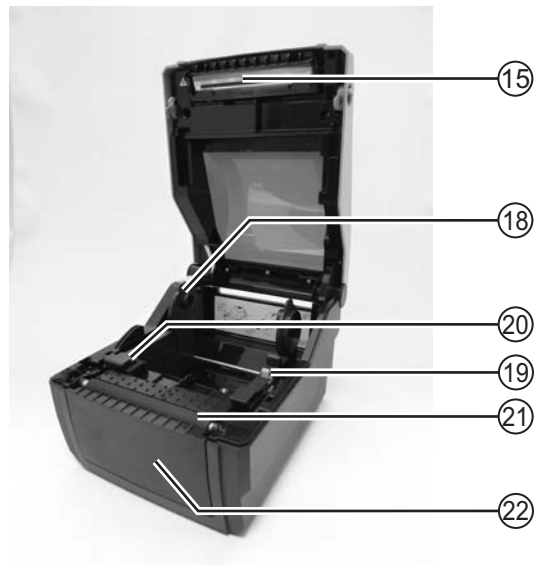

CG408DT/ CG412DT

⑮ **Print head**

This component is used to print on the media. Perform maintenance at regular intervals.

⑯ **Ribbon unit**

Used to load the ribbon and wind up the used ribbon.

⑰ **Pull out lever**

This is used to pull out the ribbon unit from the top cover for ribbon loading.

⑱ **Roll media holder**

To hold the roll media.

⑲ **Media guide slide lever**

Set to meet the size of the media used.

⑳ **Media guide and I-Mark/ Gap sensor**

A guide for the media to feed properly.

Detects the I-Mark on the media or gap of the label.

㉑ **Platen roller**

This roller feeds the media. Perform maintenance at regular intervals.

㉒ **Optional device compartment**

Used to install optional cutter or dispenser unit.

This page is intentionally left blank

2

INSTALLATION

This section assists you in installing consumable media in the printer, as well as adjustment instructions and installing other optional attachment units.

The following information is provided:

- 2.1 Site Location
- 2.2 Media Selection
- 2.3 Loading Labels
- 2.4 Loading the Carbon Ribbon (For CG408TT, CG412TT only)
- 2.5 Connections

2.1 SITE LOCATION

Consider the following when setting up the printer:

- Place the printer on a solid flat surface with adequate space. Make sure there is enough space above the printer to provide clearance for the top cover to swing open.
- Place it away from hazardous materials or dusty environments.
- Place it within operational distance of the host computer, within interface cable specifications.

2.2 MEDIA SELECTION

The size and type of the labels or paper to be printed should have been taken into consideration before printer purchase. Ideally, the media width will be equal to, or just narrower than, the print head. Using media that does not cover the print head will allow the platen roller to tread on it and wear it out. The media edge will also wear a groove in the platen roller, which can affect print quality.

Note:

For optimal print performance and durability, **please use SATO-certified label and ribbon supplies on this printer.** Using supplies not tested and approved for use by SATO can result in unnecessary wear and damage to vital parts of the printer, and may void the warranty.

This printer can print on roll media or fan-folded media. The methods used for loading roll media and fan-folded media differ. The printer uses sensors to detect I-Marks or gap on the media in order to precisely position the print content.

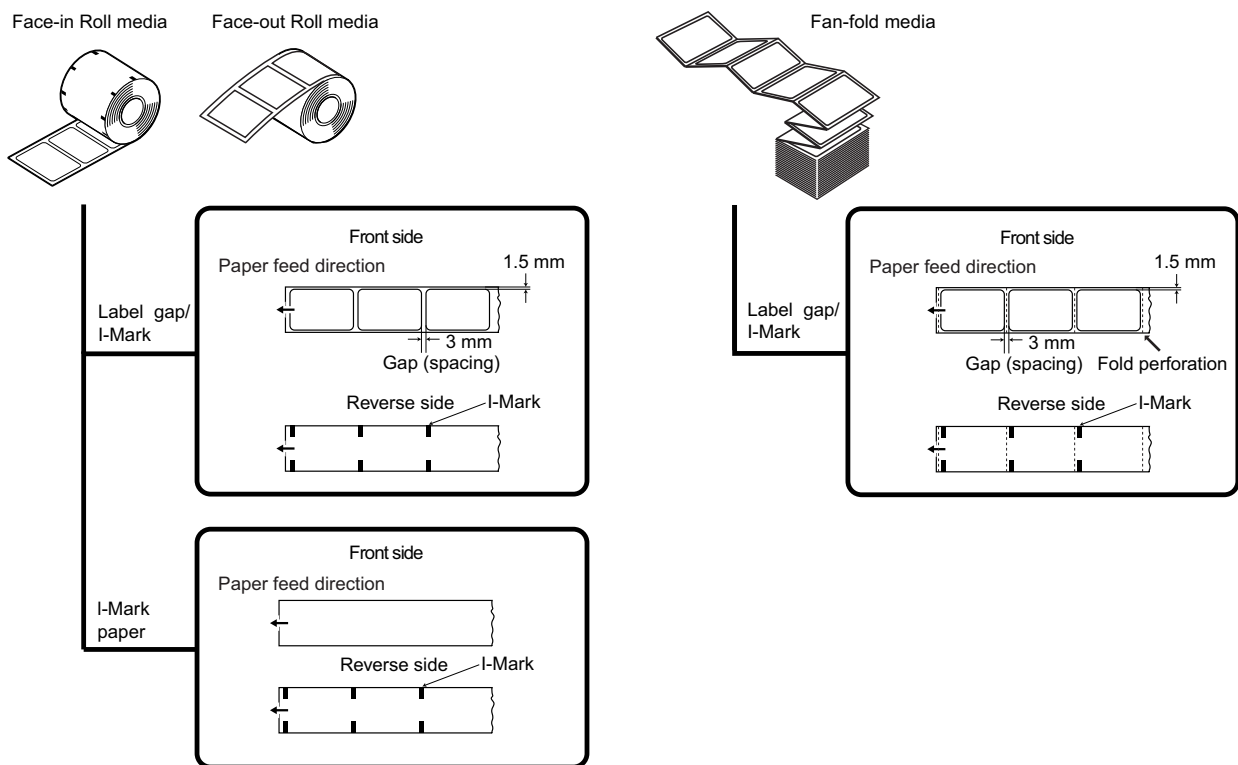

2.3 LOADING LABELS

2.3.1 Loading Roll media

1. With the power supply off, pull the **cover open/close latches** ① on both sides of the printer toward you to unlock the **top cover**, and then open the **top cover** ②.

Note:

Make sure that the cover rests firmly so that it will not fall forward and injure your hands.

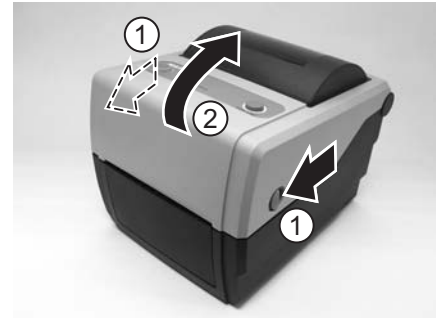

2. While holding the **media guide slide lever**, adjust the width of the **media holder** ① to match the media size.

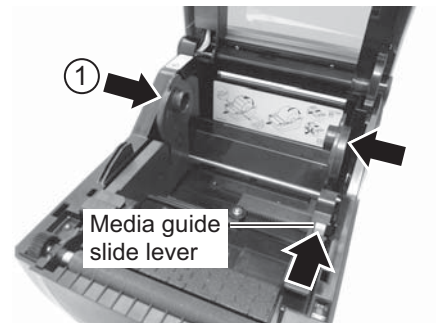

3. Load the media onto the **media holder**.

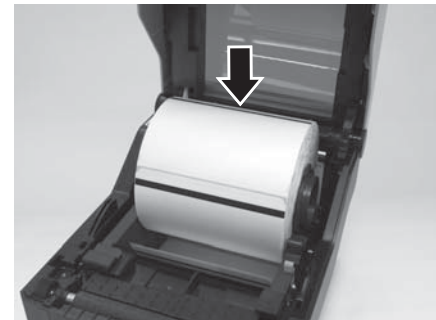

4. After pulling out the media, pass the media through the **media guides** and place the leading edge of the media on top of the **platen roller**.

Note:

Make sure the printed side of the media is facing upwards.

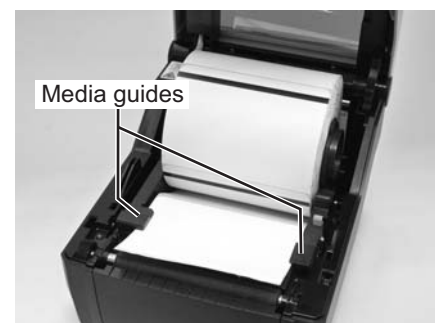

Printed side should face upwards

2.3 LOADING LABELS (cont'd)

5. Close the **top cover** until it clicks into position.

Notes:

- Be careful not to get your fingers pinched while closing the top cover.
- If the optional cutter or dispenser has been purchased, see **Section 8.1 Optional Accessories - Cutter** and **Section 8.2 Optional Accessories - Dispenser** on how to route the media.



6. After loading the media, turn on the power.
The printer is online and the **ON LINE (POWER)** indicator lights green.
When the printer is ready, press the **FEED/LINE** button to output the leading part of the media.



Caution

- When replacing media, bear in mind that the print head and its surrounding area remain hot. Keep your fingers away from these areas to prevent injury.
- Avoid touching even the edge of the print head with your bare hands.

2.3 LOADING LABELS (cont'd)

2.3.2 Loading Fan-folded media

1. With the power supply off, pull the **cover open/close latches** on both sides of the printer toward you to unlock the **top cover**, and then open the **top cover**.

Note:

Make sure that the cover rests firmly so that it will not fall forward and injure your hands.



2. Pass the fan-folded media through the opened window at the rear of the unit.

Note:

Make sure the printed side of the media is facing upwards.



3. While holding the **media guide slide lever**, adjust the width of the **media holder** (1) to match the media size. After pulling out the media, pass the media through the **media guides** and place the leading edge of the media on top of the **platen roller**.

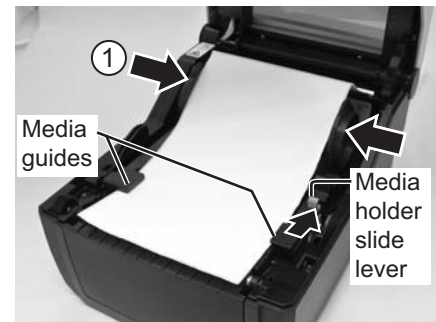

4. Close the **top cover** until it clicks into position.

Notes:

- Be careful not to get your fingers pinched while closing the top cover.
- If the optional cutter or dispenser has been purchased, see **Section 8.1 Optional Accessories - Cutter** and **Section 8.2 Optional Accessories - Dispenser** on how to route the media.

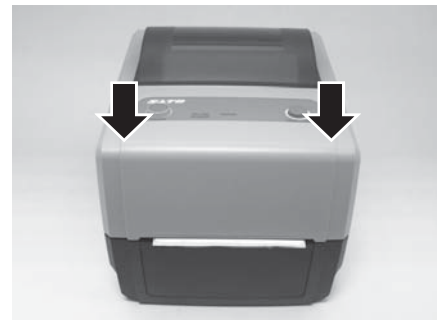

2.3 LOADING LABELS (cont'd)

5. After loading the media, turn on the power.
The printer is online and the **ON LINE (POWER)** LED lights green.
When the printer is ready, press the **FEED/LINE** button to output the leading part of the media.

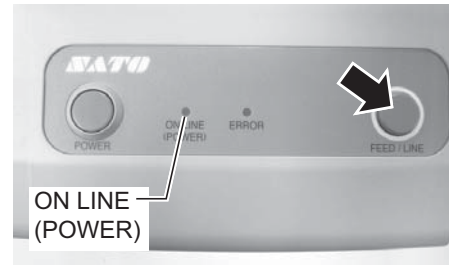

Caution

- When replacing media, bear in mind that the print head and its surrounding area remain hot. Keep your fingers away from these areas to prevent injury.
- Avoid touching even the edge of the print head with your bare hands.

2.3.3 Overview of the Roll media and Fan-folded media loading path

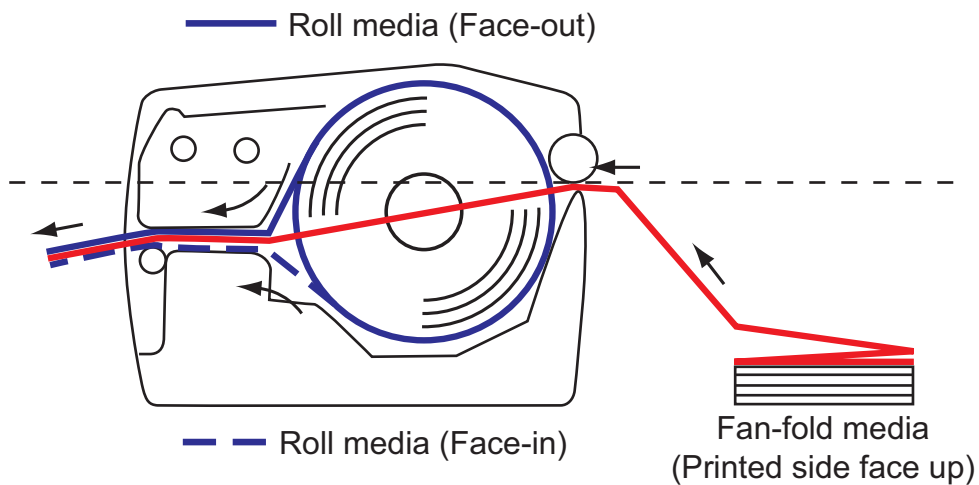

2.4 LOADING THE CARBON RIBBON (FOR CG408TT, CG412TT ONLY)

The CG408TT and C412TT printers enable two types of printing, **Thermal transfer** and **Direct thermal**. **Thermal transfer** paper media requires the use of carbon ribbon for print application. In such a scenario, it is the carbon ribbon that contains the ink that will be transferred to the media. **Direct thermal** paper media has a coating on the surface that is made visible through the application of heat from the print head. In this case, there is no need of loading the carbon ribbon.

1. With the power supply off, pull the **cover open/close latches** on both sides of the printer toward you to unlock the top cover, and then open the top cover.

Note:

Make sure that the cover rests firmly so that it will not fall forward and injure your hands.



2. Pull the **lever** on the middle of the **ribbon unit** downward to pull out the **ribbon unit**. Then simply let down the **ribbon unit**. There is a stopper midway through its movement range that will prevent the ribbon unit from snapping down.

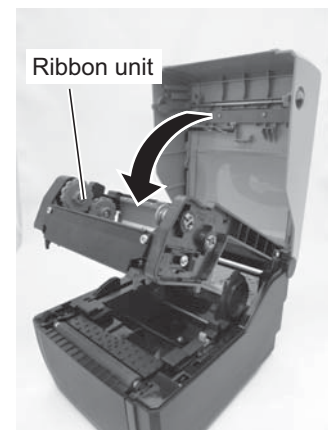
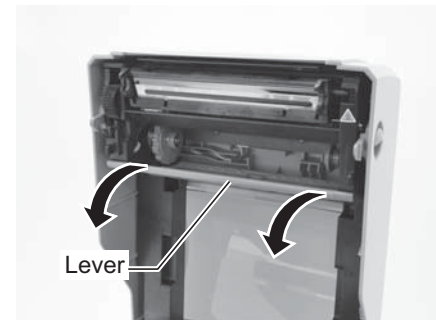

2.4 LOADING THE CARBON RIBBON (FOR CG408TT, CG412TT ONLY) (cont'd)

3. Open the carbon ribbon package, and then load the ribbon in the **ribbon supply unit**.
With the ribbon winding in clockwise direction, push in the ribbon roll to the right side of the **ribbon supply unit** ①. Then fix the other side of the ribbon roll to the left of the **ribbon supply unit** ②. Turn the ribbon roll until the core snaps on the protrusion of the left ribbon supply unit.

Note:

Use only genuine SATO carbon ribbons for maximum print quality and printer durability.

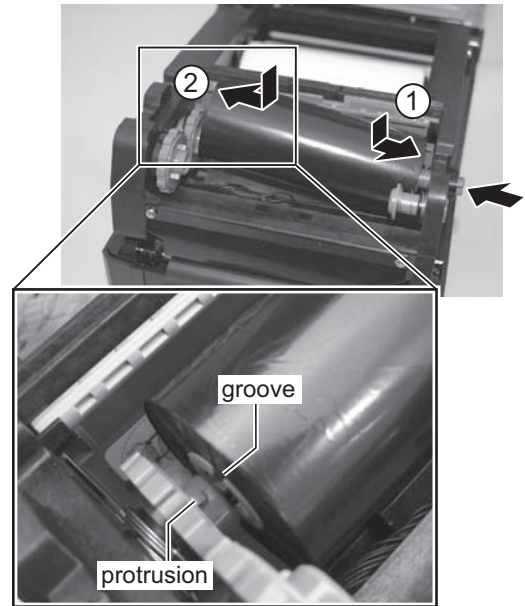

4. Mount the empty ribbon core on the **ribbon wind-up unit** the same manner as in step 3 above.
When loading the carbon ribbon for the first time, use the empty ribbon core supplied with the printer. However, the subsequent ribbon core can be obtained from the last used up ribbon roll.

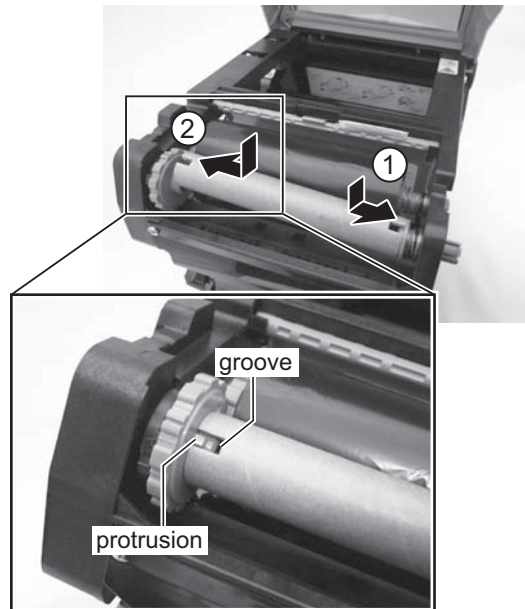

2.4 LOADING THE CARBON RIBBON (FOR CG408TT, CG412TT ONLY) (cont'd)

5. From the **ribbon supply unit**, pass the carbon ribbon underneath the print head assembly to the **ribbon wind-up unit**.

Affix the carbon ribbon to the ribbon core using adhesive tape, and wind it up several times in the direction shown by the turn arrow.

Confirm that the ribbon has been loaded as shown in the figure below or as illustrated on the inner side of the top cover.

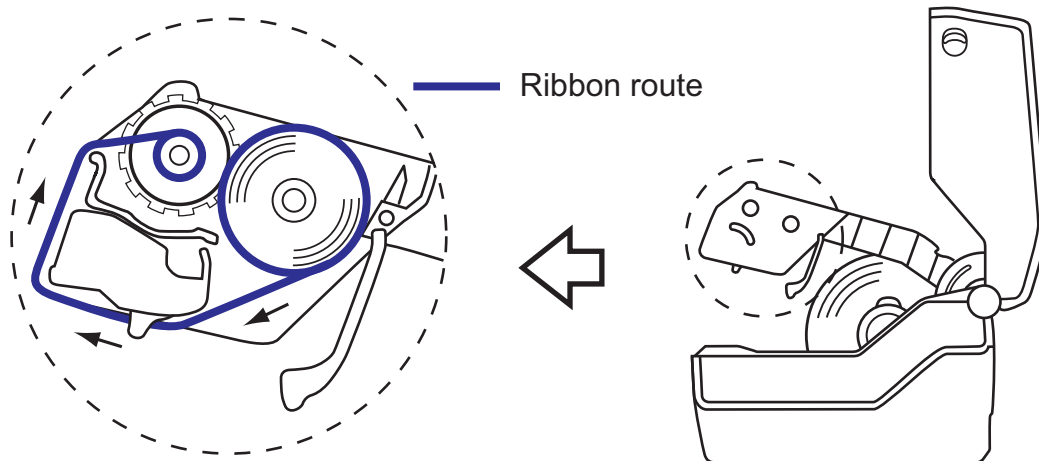
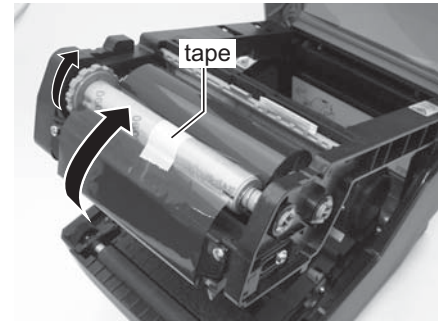

Note:

The dull side (ink side) of the ribbon should be facing outward as it travels through the print head assembly.

6. Close the **top cover** until it clicks into position.

Note:

- Be careful not to get your fingers pinched while closing the top cover.

7. After loading the media and the carbon ribbon, do a test print to check that the media roll and ribbon have been loaded properly. See **Section 3.3 User Test Print Mode** for instructions on how to run test print.



Caution

- When replacing carbon ribbon, bear in mind that the print head and its surrounding area remain hot. Keep your fingers away from these areas to prevent injury.
- Avoid touching even the edge of the print head with your bare hands.

2.5 CONNECTIONS

This section explains the power cable and interface cable connection procedures.

2.5.1 Standard interface connection

CG4 Series printers have three types of Main PCBs, and each type of PCB is equipped with different types of interface to perform data communication with the host. These are described as follows.

- 1) RS232C and USB interface on-board
- 2) LAN and USB interface on-board
- 3) USB and IEEE 1284 interface on-board

Connect **only one type** of interface cable from the printer to the host computer. Use the cable that is compatible with the standard of the interface board as stated in **Section 7: Interface Specifications**. Make sure the cable is correctly oriented.

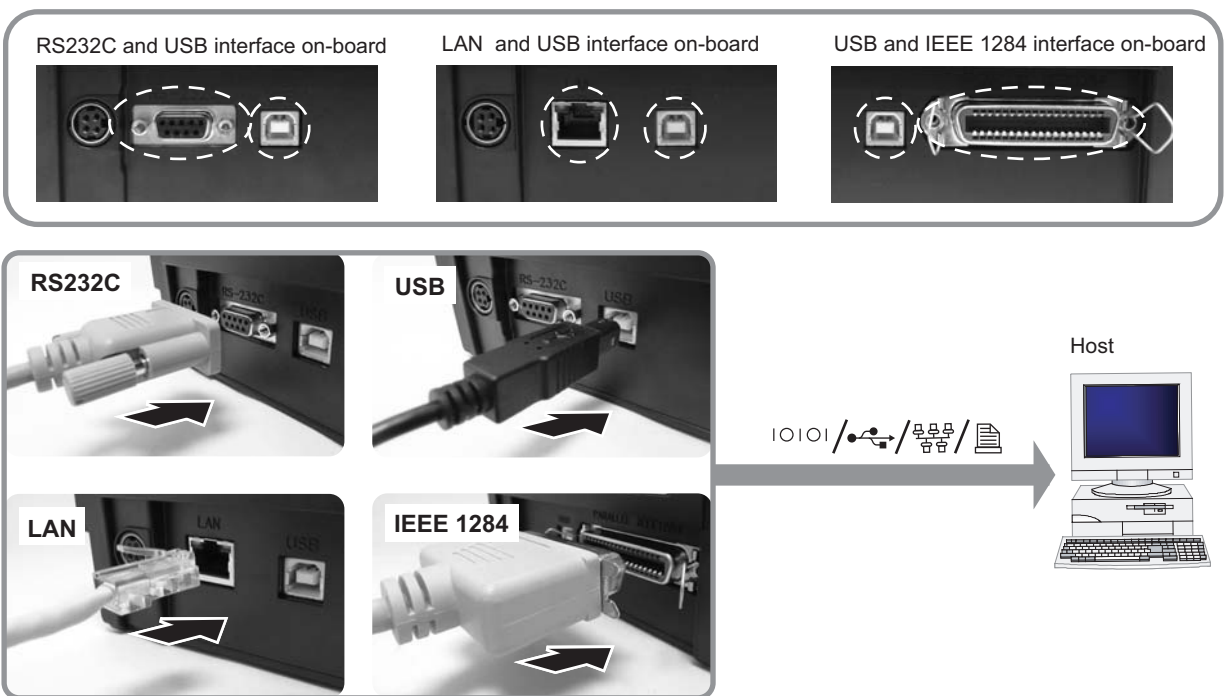

Caution

Never connect or disconnect interface cables (or use a switch box) with power applied to either the host or printer. This may caused damage to the interface circuitry in the printer/ host and is not covered by warranty.

2.5 CONNECTIONS (cont'd)

2.5.2 To activate the connected interface

After connection, you need to configure the printer to operate on the connected interface.

1. Please perform the procedures to set the appropriate interface mode as describe in **Section 3.5 Operation Setting Mode**.
2. In step 3 of this procedure, briefly press the **FEED/LINE** button repeatedly to select the interface mode according to your connection.

Connected Interface	USB	RS-232C	LAN	IEEE 1284
ON LINE (POWER) indications	●→○→○→○ Blinks in green		●→○→○→○ flashes green in a long interval	
ERROR indications	○→○→●→○ Blinks in red		○→○→○→○ Off	

2.5.3 Connecting the optional keypad/Scanner/Smart keyboard

The optional keypad, scanner or smart keyboard can be connected to the CG4 Series printer with RS-232C interface terminal, thus providing a stand-alone function. This function offers advanced features of Format Registration or Call Function without connecting to a host computer. You can use either Label Gallery or SBPL commands for the format registration. As for the data required for call function, capture it as a barcode with a scanner connected with CG4 Series printer.

1. Make sure that power cable is not connected to the printer.
2. Connect the cable from the optional device to the **RS232C** terminal at the back of the printer.

Note:

Make sure the connector is correctly oriented. Secure the printer with one hand, and insert the connector firmly.

3. Set the printer for use with the connected device. Refer to **Section 3.5 Operation Setting Mode** and perform the procedures to set the printer to **Keypad mode** or **Scanner/ Smart keyboard mode** accordingly. In step 3 of this procedure, briefly press of the **FEED/LINE** button repeatedly until the respective lighting sequence of the **ON LINE (POWER)** and **ERROR** indicator is displayed.

Notes:

- If **Keypad** or **Scanner/Smart keyboard mode** is selected, even if the device is not connected, other interfaces cannot be activated.
- Only compatible scanner, compatible smart keyboard and SATO keypad can be connected to CG4 Series printer. Refer to SATO sales representative for more details.



An example of optional keypad connection to the printer.

2.5 CONNECTIONS (cont'd)

2.5.4 Connecting the Power Cable

Warning

- Be sure to connect the ground wire. Failure to do so may cause an electric shock.
- Do not operate the power switch or insert/remove the power cable while your hands are wet. Doing so may cause an electric shock.

Caution

The power cable and the AC adapter provided with this printer are for use with this printer only. They cannot be used with other electrical devices.

1. Connect the AC power cable to the AC adapter.

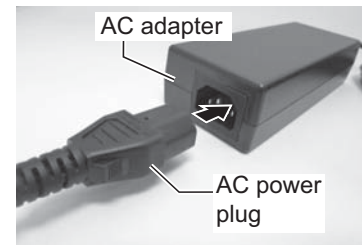

2. Connect the DC power plug from the AC adapter to the **DC input power terminal** on the back of the printer. Make sure the flat side of the DC power plug is facing right. Secure the printer with one hand, and insert the cable firmly.

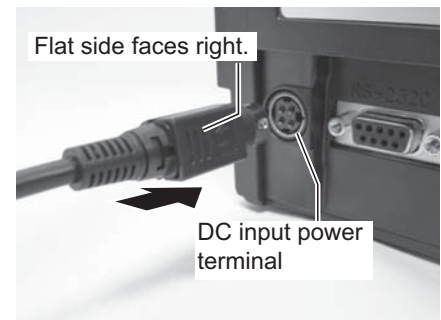

3. Insert the AC power plug into a AC power outlet. Make sure that the AC voltage of your region is within the range of AC 100 to 240V, 50/60 Hz. A 3-pin plug is attached to the power cord provided with your printer. One of these pins is the ground wire. You must use a 3-pin power outlet. The plug will not work with a 2-pin power outlet.

* The shape of the power plug may vary depending on the location where the printer was purchased.

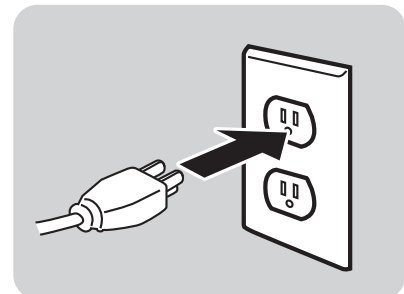

2.5 CONNECTIONS (cont'd)

2.5.5 Turning On the Power

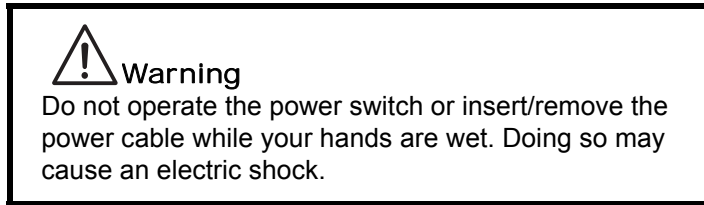

Press the **POWER** on the operation panel of the unit.
The **ERROR** indicator displays red, then after a single beep sound, the **ON LINE (POWER)** indicator displays green.

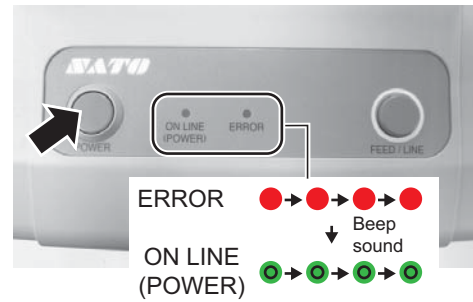

2.5.6 Turning Off the Power

When you have completed the printing job, turn the printer off.

Be sure to confirm that the printer is in the offline status.
Press and hold the **POWER** button until the **ERROR** indicator displays red and then turns off.

If there is any printed paper remaining in the printer, cut it off.



This page is intentionally left blank

3

OPERATION AND CONFIGURATION

Before using the printer, it is best to read this manual thoroughly. Otherwise, you may disturb default settings on which the instructional procedures in this manual are based.

Most of the printer's settings are controlled via standard SBPL commands or by using the provided SATO Utilities Tool application.

Some printer settings may be manually configured via the **POWER** and **FEED/LINE** buttons with the **ON LINE (POWER)** indicator and **ERROR** indicator on the front of printer. All of the printer's buttons are used either singularly, or together, to perform configuration activities. The instructions to these operations are described in this section.

3.1 OPERATOR PANEL

The operator panel located on the top front, consists of two buttons and two LED indicators (red and green).

- **POWER** button
Press **POWER** button to turn on or off the printer.
Press **POWER** button together with **FEED/LINE** button to enter various operating modes.

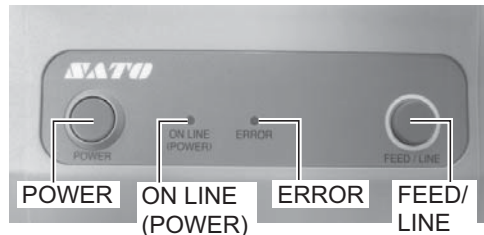

- **FEED/LINE** button
 - Press **FEED/LINE** button during normal print operation to pause the printing and set the printer to offline mode. Press again to toggle the printer between the online and offline mode.
 - When printer idles in online mode, press the **FEED/LINE** button to feed a blank label.
 - During label feed, press the **FEED/LINE** button to pause label feed and go offline.
 - The printer will go offline after opening and closing the top cover. Press the **FEED/LINE** button to make the printer go online.

- **ON LINE (POWER)** and **ERROR** indicators

When the printer is in normal mode, this two indicators notifies the user of various status conditions:

LED Indicator	Color	Functions
ON LINE (POWER)	Green	Illuminates when printer is ready to receive data or is in printing mode (Online). Blinks when the printer is in offline mode.
ERROR	Red	Illuminates or blinks when there is a system fault, for example, paper end.

During different operation modes, the **ON LINE (POWER)** and **ERROR** indicators turn on and flash differently.

In this section, the combination of the following symbols has been used to describe the indicator lighting sequence. Refer to the example listed below for lighting sequences.

Indicator symbol	Status
○	Off
●	Red light
●	Green light

The repeating patterns are as shown in the below examples. The sequences are indicated as from left to right. One LED Indication flash is approximately 200ms, and two indication flashes in a row are for about 400ms.

Example 1	Indicator: Red light.	●→●→●→●
Example 2	Indicator: Green light.	●→●→●→●
Example 3	Indicator: Blinking red light.	●→○→●→○
Example 4	Indicator: Blinking green light.	●→○→●→○
Example 5	Indicator: off	○→○→○→○

3.2 OPERATING MODES

You can set the printer in any of the following modes:

1. Normal mode (including Online/Offline modes)
2. User Test print mode
3. Factory Test print mode
4. Operation Setting mode:
 - Program download mode
 - Font download mode
 - Default setting mode
 - HEX Dump mode
 - USB interface
 - RS-232C/ LAN/ IEEE 1284 interface
 - Keypad selection
 - Scanner, Smart keyboard

You can access the modes by pressing and releasing the **POWER** button and the **FEED/LINE** button at particular points during the **ON LINE (POWER)** and **ERROR** indicators' lighting sequence.

The following flow chart provides a clear summary of each of the modes and its access method.

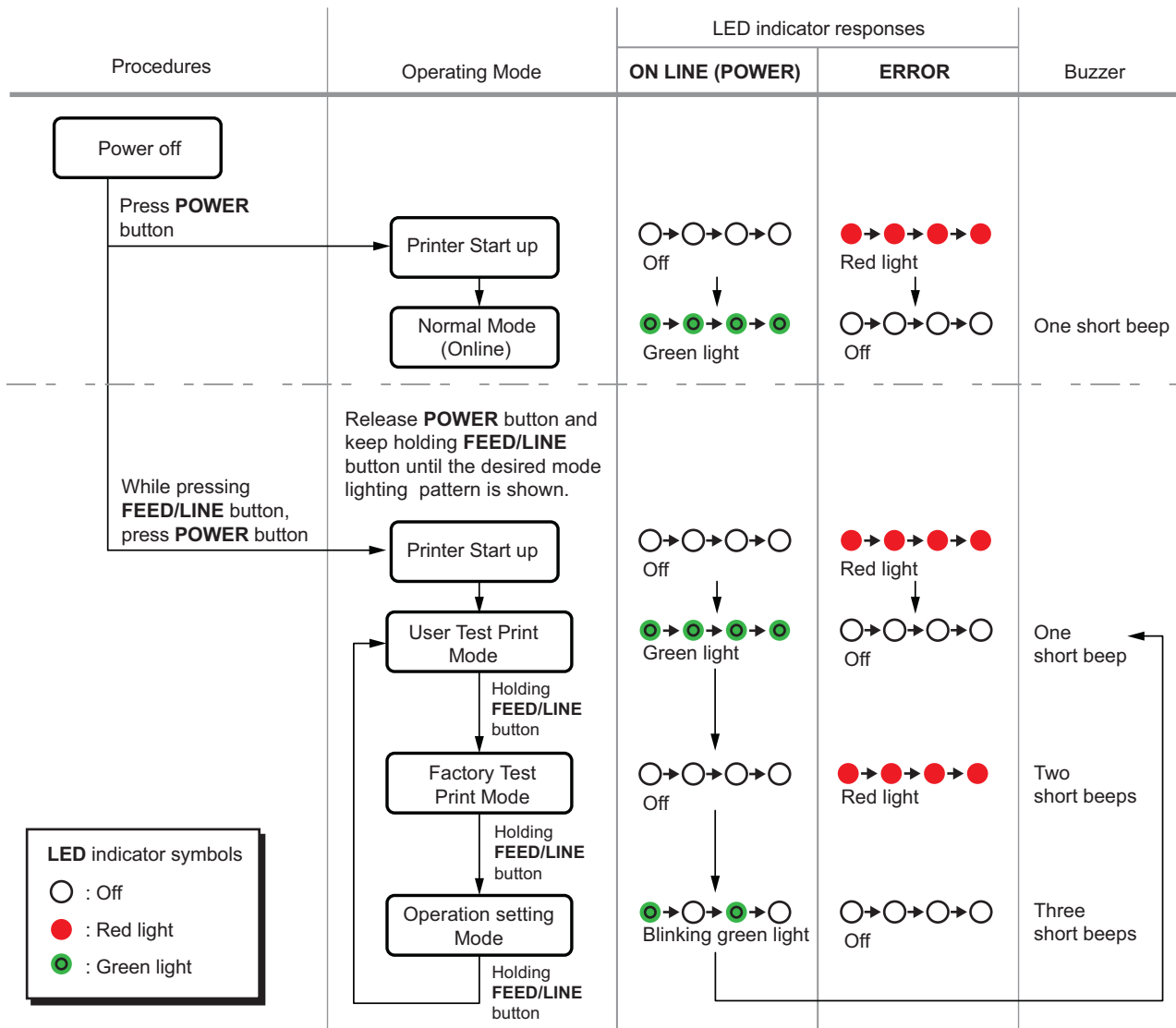













3.3 USER TEST PRINT MODE

This mode produces test labels for diagnostic purposes.

Preparation:

Make sure the media or ribbon (if required) are properly loaded in the printer.

Procedures	Printer status	ON LINE (POWER) indicator	ERROR indicator	Buzzer
<p>1 While pressing FEED/LINE button, press and release POWER button. Keep holding FEED/LINE button.</p>	Printer start-up	 Off	 Red light	
<p>2 Release FEED/LINE button when ON LINE (POWER) indicator changes to green light and single short beep sound is heard.</p> <p>(The printer will cyclically advance to next mode as long as the FEED/LINE button is held down.)</p>	User Test Print mode.  FEED/LINE released	 Green light	 Off	One short beep
	User Test Print mode is activated and then paused.	 Blinking green light	 Off	
<p>3 Press FEED/LINE button to start test printing.</p>	User Test Print start and print continuously. 	 Green light	 Off	
Press FEED/LINE button to pause the test printing. Press again to resume.	User Test Print paused. 	 Blinking green light	 Off	

Notes:

- If you missed the chance to release the **FEED/LINE** button in step 2 above, just keep holding the **FEED/LINE** button and wait for the next cycle.
- If you released the **FEED/LINE** button at the wrong **ON LINE (POWER)** or **ERROR** indicators, just turn off the power and restart the procedure.
- The printer will continuously print the user test labels until the **FEED/LINE** button is pressed. The printing is paused and will resume printing if the **FEED/LINE** button is press again.

To terminate the User Test Print mode

First, ensure that you have pressed the **FEED/LINE** button to pause the test printing, then press **POWER** to turn off the printer.

3.3 USER TEST PRINT MODE (cont'd)

3.3.1 Output Data of the User Test Print

The output data of the User Test Print shows the current settings of the printer.

These output data are printed in three parts, each with the printing area of 110mm [4.33"] (Width) x 115mm [4.53"] (Pitch), Standard.

First print-out (Settings)

No.	Print Item		Contents of the print data
1	Model	Printer model name	CG408TT(*), CG412TT(*) CG408DT, CG412DT *: "T" is printed for thermal transfer print. "D" is printed for direct thermal print.
2	Offset	Offset value (Vertical and horizontal directions)	(H)±300 (V)±300 DOT
3	Pitch Offset	Pitch offset value	±099 DOT
4	Cut Offset	Cut position offset value	±099 DOT
5	Peel Offset	Peel off position offset value	±099 DOT
6	Tear Off Offset	Tear off position offset value	±099 DOT
7	Label Size	Label size (Pitch/Width)	(P)**** x (W)*** DOT
8	Print Speed	Print speed	50mm/s 75mm/s 100mm/s
9	Print Darkness	Print darkness	1A~5A
10	Operation mode	Operation mode	CUT/ NONE SEPA/ TEAR OFF/ DISPENSER/ CONTINUOUS
11	Sensor Type	Sensor type	Gap I-Mark None
12	Paper End Search	Paper end detection method	TAG/ ROLL
13	Zero Slash	Zero slash	ON/ OFF
14	Proportional Pitch	Proportional pitch	ON/ OFF
15	Buzzer	Buzzer	ON/OFF
16	Initial Feed	Initial feed	ON/ OFF
17	Protocol-codes	Protocol code setting value (Standard / Nonstandard)	Nonstandard/ Standard
18	Option waiting time	Option waiting time	500 to 20000 ms
19	Num of formats stored	Number of formats stored	*
20	Printer mode	Printer mode	ONLINE/ STANDALONE

3.3 USER TEST PRINT MODE (cont'd)**Second print-out (Protocol code setting values)**

No.	Print Item	
1	STX	
2	ETX	
3	ESC	
4	ENQ	
5	CAN	
6	NULL	
7	OFFLINE	
8	AUTO ONLINE	
9	ZERO SLASH	Zero slash
10	EURO	Euro code

Third print-out (Interface)**USB and RS-232C interface on board**

No.	Print Item		Contents of the print data
1	Selected Interface	In-use interface	USB / RS-232C / Keypad / Scanner
2	Interface 1	Interface 1	USB
3	Buffer Type	Buffer type	Multi
4	Protocol	Protocol	Driver
5	Serial No.	Serial No.	Serial No./ None
6	Interface 2	Interface 2	RS-232C
		Communication parameters	(19200.8.N.1) Baud rate (bps) 9600, 19200, 384000 Data length (bit) 8, 7 Parity N, O, E Stop bit (bit) 1 2
7	Buffer Type	Buffer type	1 item / Multi
8	Protocol	Protocol	ER/RS XON/XOF Driver Status3

3.3 USER TEST PRINT MODE (cont'd)

USB and IEEE 1284 interface on board

No.	Print Item		Contents of the print data
1	Selected Interface	In-use interface	USB / IEEE1284
2	Interface 1	Interface 1	USB
3	Buffer Type	Buffer type	Multi
4	Protocol	Protocol	Driver
5	Serial No.	Serial No.	Serial No./ None
6	Interface 2	Interface 2	IEEE1284
7	Buffer Type	Buffer type	Multi / 1 item
8	Protocol	Protocol	Driver

USB and LAN interface on board













No.	Print Item		Contents of the print data
1	Selected Interface	In-use interface	USB / LAN
2	Interface 1	Interface 1	USB
3	Buffer Type	Buffer type	Multi
4	Protocol	Protocol	Driver
5	Serial No.	Serial No.	Serial No./ None
6	Interface 2	Interface 2	LAN
7	Buffer Type	Buffer type	Multi
8	Protocol	Protocol	Driver(CYC) Driver(ENQ) Status3
9	MAC Address	MAC address	***.***.***.***
10	IP Address	IP address	000.000.000.000 ~ 255.255.255.255
11	Subnet Mask	Subnet mask	000.000.000.000 ~ 255.255.255.255
12	Default Gateway	Default gateway	000.000.000.000 ~ 255.255.255.255
13	DHCP	DHCP	Enable / Disable
14	RARP	RARP	Enable / Disable

3.4 FACTORY TEST PRINT MODE

This mode produces test labels for diagnostic purposes.

Preparation:

Make sure the media or ribbon (if required) are properly loaded in the printer.

Procedures	Printer status	ON LINE (POWER) indicator	ERROR indicator	Buzzer
<p>1 While pressing FEED/LINE button, press and release POWER button. Keep holding FEED/LINE button.</p>	Printer start-up	 Off	 Red light	
<p>2 Release FEED/LINE button when ERROR indicator changes to red light and two short beeps sound are heard.</p> <p>(The printer will cyclically advance to next mode as long as the FEED/LINE button is held down.)</p>	User Test Print Mode.	 Green light	 Off	One short beep
	<p>Factory Test Print Mode.</p> <p style="text-align: center;">↓</p> <p style="text-align: center;"> FEED/LINE released</p>	 Off	 Red light	Two short beeps
	<p>Factory Test Print mode is activated and then paused.</p>	 Blinking green light	 Off	
<p>3 Press FEED/LINE button to start test printing.</p>	FactoryTest Print start and print continuously.	 Green light	 Off	
<p>Press FEED/LINE button to pause the test printing. Press again to resume.</p>	Factory Test Print paused.	 Blinking green light	 Off	

Notes:

- If you missed the chance to release the **FEED/LINE** button in step 2 above, just keep holding the **FEED/LINE** button and wait for the next cycle.
- If you released the **FEED/LINE** button at the wrong **ON LINE (POWER)** or **ERROR** indicators, just turn off the power and restart the procedure.
- The printer will continuously print the Factory test labels until the **FEED/LINE** button is pressed. The printing is paused and will resume printing if the **FEED/LINE** button is press again.

To terminate the Factory Test Print mode

First, ensure that you have pressed the **FEED/LINE** button to pause the test printing, then press **POWER** to turn off the printer.

3.4 FACTORY TEST PRINT MODE (cont'd)

3.4.1 Output Data of the Factory Test Print

The output data of the Factory Test Print shows the internal operating parameters of the printer. These output data are printed in three parts, each with the printing area of 110mm [4.33"] (Width) x 115mm [4.53"] (Pitch), Standard.

First print-out (Settings)

No.	Print Item		Contents of the print data
1	Model	Printer model name	CG408TT(*), CG412TT(*) CG408DT, CG412DT *: "T" is printed for thermal transfer print. "D" is printed for direct thermal print.
2	Firm Ver	Printer F/W version	**.*.*.*
3	Firm Date	Printer F/W creation date	YY.MM.DD
4	Font Version	Font version	**.*
5	Serial No.	Serial No.	Serial No./ None
6	Life Counter	Life counter	*.* Km
7	Head Counter1	Head counter 1	*.* Km
8	Head Counter2	Head counter 2	*.* Km
9	Head Counter3	Head counter 3	*.* Km
10	Cutter Counter	Cutter counter	*
11	Thermistor	Print head temperature	0 to 255
12	Sensor Type	Sensor type	Gap I-Mark None
13	Sensor Level Low	Average minimum value of pitch sensor	*.* V
14	Sensor Level High	Average maximum value of pitch sensor	*.* V
15	Sensor Slice Level	Pitch sensor slice level	*.* V
16	FROM CHECK SUM	Printer F/W: Font: Check sum	(A)**** (B)**** (P)****
17	Sensor Out Level I-mark	I-Mark level	*
18	Sensor Out Level Gap	Gap level	*

3.4 FACTORY TEST PRINT MODE (cont'd)**Second print-out (Settings)**

No.	Print Item		Contents of the print data
1	Model	Printer model name	CG408TT(*), CG412TT(*) CG408DT, CG412DT *: "T" is printed for thermal transfer print. "D" is printed for direct thermal print.
2	Offset	Base reference correction (Vertical and horizontal directions)	(H)±300 (V)±300 DOT
3	Pitch Offset	Pitch offset value	±099 DOT
4	Cut Offset	Cut position correction value	±099 DOT
5	Peel Offset	Peel off position correction value	±099 DOT
6	Tear Off Offset	Tear off position correction value	±099 DOT
7	Label Size	Label size (Pitch/Width)	(P)**** x (W)*** DOT
8	Print Speed	Print speed	50mm/s, 75mm/s, 100mm/s
9	Print Darkness	Print darkness	1A~5A
10	Sensor Type	Sensor type	Gap / I-Mark / None
11	Sensor Level Low	Average minimum value of pitch sensor	*.* V
12	Sensor Level High	Average maximum value of pitch sensor	*.* V
13	Sensor Slice Level	Pitch sensor slice level	*.* V
14	Paper End Search	Paper end detection method	TAG/ ROLL
15	Zero Slash	Zero slash	ON/ OFF
16	Proportional Pitch	Proportional pitch	ON/ OFF
17	Buzzer	Buzzer	ON/OFF
18	Initial Feed	Initial feed	ON/ OFF
19	Operation mode	Operation mode	CUT/ NONE SEPA/ TEAR OFF/ DISPENSER/ CONTINUOUS
20	Option waiting time	Option waiting time	500 to 20000 ms
21	Protocol-codes	Protocol code setting value (Standard / Nonstandard)	Nonstandard/ Standard

Third print-out (Interface)









This interface information is similar to the third print-out in user test print mode. Refer to **Section 3.3.1 Output Data of the User Test Print** for details.

3.5 OPERATION SETTING MODE

The operation setting mode enables further selection of the functions of the printer. These are:





















- Program download mode
- Font download mode
- Default setting mode
- HEX dump mode
- USB interface
- RS-232C/ IEEE 1284/ LAN interface
- Keypad selection
- Scanner/ Smart keyboard selection

Selection of the above operation setting modes are as shown below.

Procedures	Printer status	ON LINE (POWER) indicator	ERROR indicator	Buzzer
<p>1 While pressing FEED/LINE button, press and release POWER button. Keep holding FEED/LINE button.</p> <p>2 Release FEED/LINE button when ON LINE (POWER) indicator changes to blinking green light and three short beeps sound are heard.</p> <p>(The printer will cyclically advance to next mode as long as the FEED/LINE button is held down.)</p>	Printer start-up	 Off	 Red light	
	User Test Print Mode.	 Green light	 Off	One short beep
	↓ Factory Test Print Mode	 Off	 Red light	Two short beeps
	↓ Operation Setting Mode	 Blinking green light	 Off	Three short beeps

To be continued on the next page. 

3.5 OPERATION SETTING MODE (cont'd)

Procedures	Printer status	ON LINE (POWER) indicator	ERROR indicator	Buzzer
<p>3 Press the FEED/LINE button repeatedly to select different operation setting mode cyclically.</p> <div style="border: 1px solid gray; border-radius: 15px; padding: 10px; margin-top: 20px;"> <p>* Keypad and Scanner/ Smart keyboard selection is only available for USB and RS-232C board printer. If this selection is selected, even if the device is not connected, other interfaces cannot be activated.</p> </div>	<div style="border: 1px solid black; padding: 5px; text-align: center;">Program Download Mode</div>	 Blinking green light	 Off	Three short beeps
	<div style="border: 1px solid black; padding: 5px; text-align: center;">Font Download Mode</div>	 Off	 Red light	
	<div style="border: 1px solid black; padding: 5px; text-align: center;">Default setting Mode</div>	 Off	 Blinking red light	
	<div style="border: 1px solid black; padding: 5px; text-align: center;">HEX Dump Mode</div>	 Blinking green light	 Blinking red light	
	<div style="border: 1px solid black; padding: 5px; text-align: center;">USB interface</div>	 Blinking green light	 Blinking red light	
	<div style="border: 1px solid black; padding: 5px; text-align: center;">RS-232C/ LAN/ IEEE1284 interface</div>	 Blinking green light (longest blink interval)	 Off	
	<div style="border: 1px solid black; padding: 5px; text-align: center;">Keypad is selected*</div>	 Off	 Blinking red light (longest blink interval)	
	<div style="border: 1px solid black; padding: 5px; text-align: center;">Scanner/ Smart keyboard is selected*</div>	 Blinking green light (longest blink interval)	 Blinking red light (longest blink interval)	
<p>4 When the desired mode is selected, press the FEED/LINE button for more than 3 seconds until both the ON LINE (POWER) and ERROR indicator is turned off.</p>	Confirmation of the selected mode. (while pressing FEED/LINE)	 Off	 Off	One short beep
	Completion of function execution. (after release of FEED/LINE)	 Green light (except for download mode, in which case the ERROR indicator will be lighted in red instead.).	 Off	Three short beeps
<p>5 Press the POWER button to turn off the printer, then press again to turn it on.</p> <p>(NOTE: This step is NOT required for download mode.)</p>	The selected mode will be valid by restarting the printer. (For download mode selection, the printer will continue to complete the downloading process. Refer to section 3.6 and 3.7 for details.)			

3.5 OPERATION SETTING MODE (cont'd)

Notes:

- Press the **FEED/LINE** button to select the desired function, and then execute the selected function by pressing and holding the **FEED/LINE** button for more than 3 seconds.
- When the desired interface is selected, this setting will be valid after you restart the printer.
- When HEX dump mode is selected, the printer will be set to this mode only once by restarting the printer.
- When download mode is selected, the printer will be reset automatically and it enters the desired download mode.
- When the default setting mode is selected and executed, the printer will be set to default setting.
- Make sure that the function execution is complete (**ON LINE (POWER)** indicator: Green light) before turning off the printer.

3.6 PROGRAM DOWNLOAD MODE

In this mode, the printer is set to receive an application program from the host computer to download into its memory. Remember to set the printer to the correct active interface to be used for the data transfer.

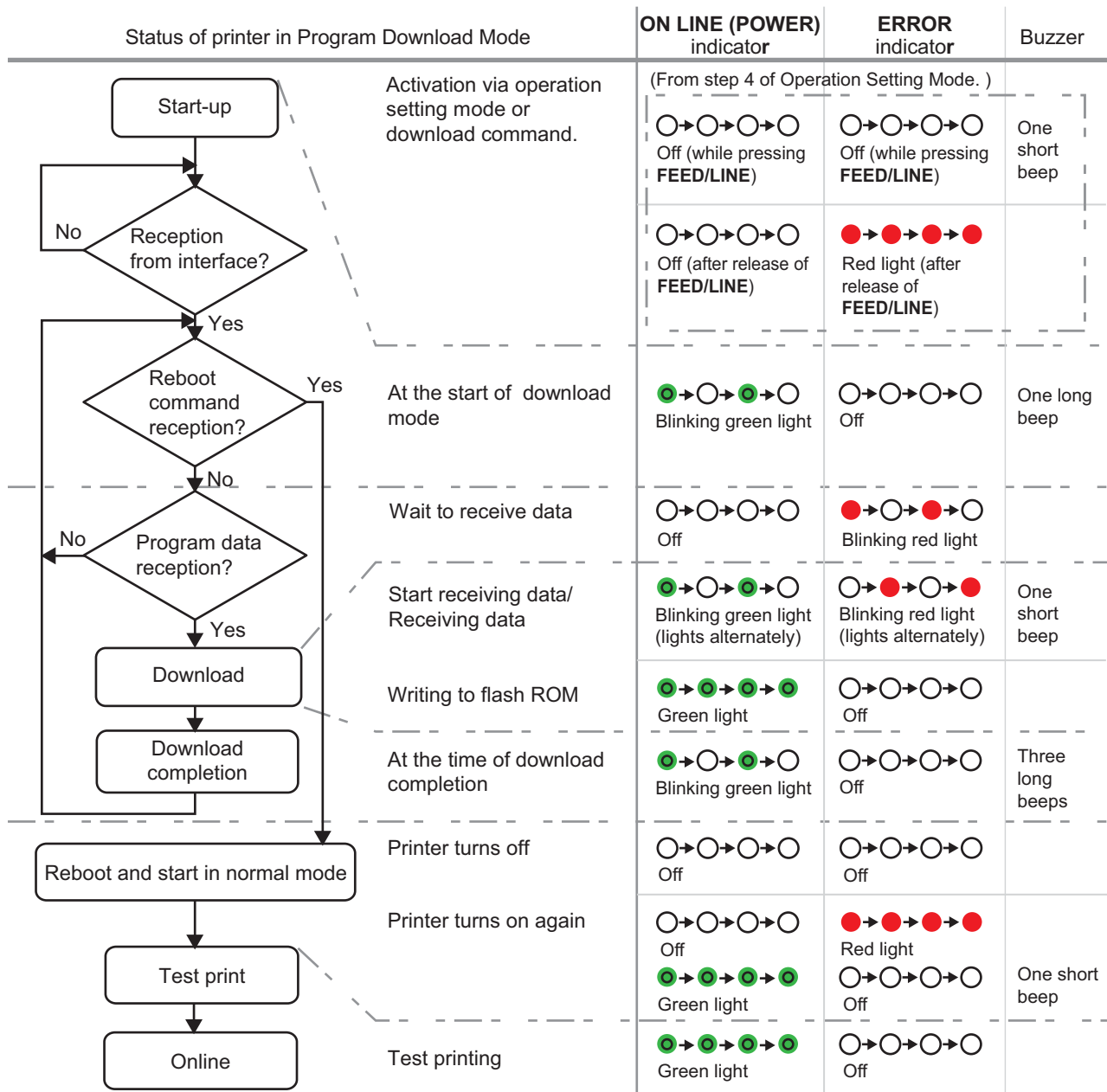

3.6 PROGRAM DOWNLOAD MODE (cont'd)



Caution

- Downloading firmware will initialize all the previous settings (set by Utilities tool application or by commands). Write down its setting details or keep a copy of FACTORY TEST PRINT for your information in case you wish to maintain the same settings in the future.
- DO NOT turn the printer OFF when data is transferring to the flash ROM in Program or Boot Download mode, as it may corrupt the firmware and prevent the printer from starting up correctly.

Notes:

- Use the selected interface for PC connection.
- Restart the printer in order to activate the Downloaded program. When starting the printer in normal mode for the first time, it makes the first factory test print. If no media is set in the printer, the printer will have a paper end error.
- When not receiving reboot command, manually reboot the printer and restart in normal operation mode.
- Ensure that the printer is in the “Wait to receive data” status (**ERROR** indicator: blinking red light) before you manually turn off the printer.
- During the process of downloading, if **ON LINE (POWER)** and **ERROR** indicators respond differently from above mentioned procedure, an error may have occurred. Please refer to **Section 3.10 Error Occurrence While Downloading** for details.

3.6.1 Firmware Download

The following listed the downloadable firmware according to the connected interface.

Interface	Targeted firmware	
	Printer firmware	Keypad firmware
RS-232C	○	–
USB	○	–
Onboard LAN	○	–
IEEE 1284	○	–
SD card for Keypad	x	○

○: Downloadable x: Undownloadable –: Not available

3.7 FONT DOWNLOAD MODE

In this mode, the printer is set to download fonts from the host computer. Remember to set the printer to the correct active interface to be used for the data transfer.

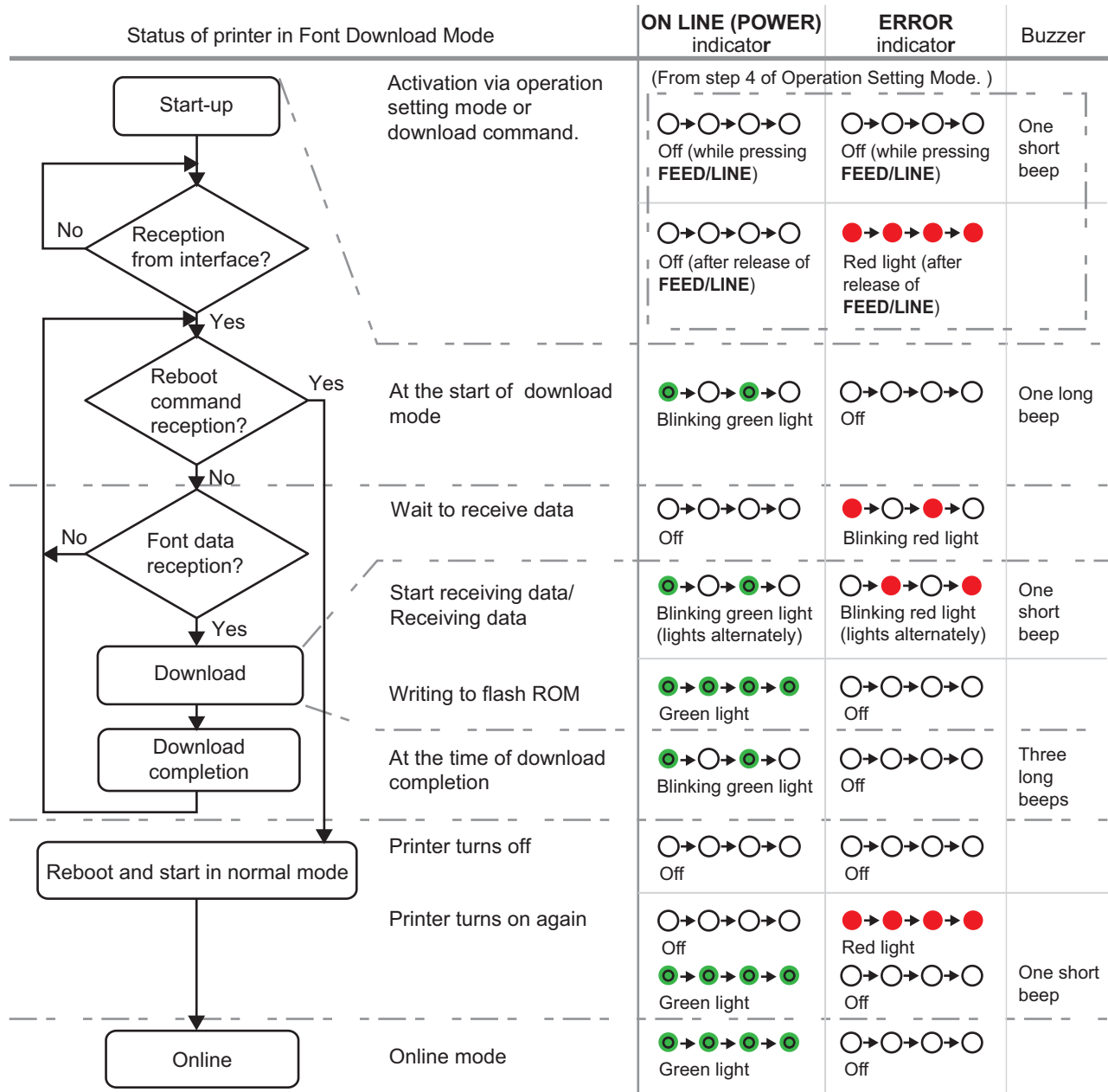

Notes:

- Use the selected interface for PC connection.
- The downloaded font goes into effect when you restart the printer.
- When not receiving reboot command, manually reboot the printer and restart in normal operation mode.
- Ensure that the printer is in the “Wait to receive data” status (**ERROR** indicator: blinking red light) before you manually turn off the printer.
- During the process of downloading, if **ON LINE (POWER)** and **ERROR** indicators respond differently from above mentioned procedure, an error may have occurred. Please refer to **Section 3.10 Error Occurrence While Downloading** for details.

3.8 DEFAULT SETTING MODE

When default setting mode is selected and executed in Operation Setting mode (refer to **Section 3.5 Operation Setting Mode**), the printer will reset to the default setting (factory preset) as listed below.

No.	Items to be reset	Default value	
1	Offset (V, H)	Vertical = 0 dot, Horizontal = 0 dot	
2	Pitch Offset	0 dot	
3	Cut Offset	0 dot	
4	Dispensing Offset	0 dot	
5	Tear-Off Offset	0 dot	
6	Label Size	Pitch 896 dot x Width 832 dot [203 dpi] Pitch 1344 dot x Width 1248 dot [305 dpi]	
7	Print Speed	75 mm/sec (3 Inches/sec)	
8	Print Darkness	3A	
9	Sensor Type	Gap	
10	Paper End Search	Roll	
11	Zero Slash	Enabled	
12	Proportional Pitch	Enabled	
13	Initial Feed	Disabled	
14	Auto Feed	Disabled	
15	Operation mode	Continuous	- (No setting)
		Tear Off	- (No setting)
		Cutter	Mode 1 (Head position)
		Dispenser	Mode 1 (Head position)
16	Interface	RS-232C	Baud rate=19200 bps, Protocol = Protocol for driver
		LAN	Protocol for driver (ENQ response mode) *1
		IEEE 1284	Protocol = Protocol for driver
		USB	Protocol = Protocol for driver

*1. To be connected by Port1024 and Port1025 (2 port connections) or Port 9100 (1 port connection)

3.9 HEX DUMP MODE

HEX Dump Mode allows you to print the contents of the receive buffer in a hexadecimal format. This feature allows the data stream to be examined for errors and troubleshooting.

After selecting the HEX Dump Mode in Operation Setting Mode, restart the printer (refer to **Section 3.5 Operation Setting Mode**). The printer then awaits data feeds and when data arrives, it prints out the HEX data continuously.

To exit the HEX Dump Mode, restart the printer by turning off the printer and then on again.

3.10 ERROR OCCURRENCE WHILE DOWNLOADING

The following are the possible causes of errors in program/font download.

- (1) The flash ROM may be in a state that fails to permit data being written to it.
- (2) Incorrect data are received while transferring downloaded data.

3.10.1 Operation Status when having an Error in Downloading Process

The **ERROR** indicator and buzzer response when having an error in downloading process are as follows.

Operation status	ON LINE (POWER) indicator	ERROR indicator	Buzzer
Flash ROM error	Off ○→○→○→○	Red light ●→●→●→●	1 long beep sound
Download data error	Off ○→○→○→○	Long blink interval ●→●→○→○	1 long beep sound



Caution

- DO NOT turn the printer OFF when data is transferring to the flash ROM in Program or Boot Download mode, as it may corrupt the firmware and prevent the printer from starting up correctly.
- Ensure to check the printer status when downloading, and do not turn off the printer during download.
- Ensure that the printer is running on a stable power supply during flash ROM writing operations.

3.11 PRINTER CONFIGURATIONS SETTING

You can set the printer configuration by sending SBPL commands from the host computer or by using the Utilities Tool application provided (SATO Accessory CD-ROM).

No.	Category	Setting item	Setting contents
1	Operation mode	Print method (CG406TT/ CG412TT printer only)	Thermal Transfer/ Direct Thermal
2		Print speed	50mm/s to 100mm/s
3		Print mode	Continuous/ Tear Off/ Cutter/ Dispenser/ non-sepa (Linerless)
4		Cutter mode	Head position/ Cut position/ No backfeed
5		Dispenser mode	Head position/ Dispense position
6		nonsepa mode	Tear Off position/ No backfeed
7		Print darkness	A
8		Print darkness level	1 to 5
9		Sensor type	I-Mark/Gap/Sensor-off/Transmissive (CX compatible)
10		Zero slash	Disabled/ Enabled
11		Kanji code	JIS code/SJIS code
12		Initial feed	Disabled/ Enabled
13		Character pitch	Fixed/ Proportional
13		Option Waiting time	5 to 200 (x100ms)
14	Media size	Pitch	1 to 2400 dots (including liner/backing paper) [CG408TT/DT] 1 to 3600 dots (including liner/backing paper) [CG412TT/DT]
15		Width	1 to 832 dots (including liner/backing paper) [CG408TT/DT] 1 to 1248 dots (including liner/backing paper) [CG412TT/DT]
16	Base reference point	Vertical print position offset	±792dot
17		Horizontal print position offset	±792dot
18	Offset setting	Continuous mode	±99dot
19		Tear Off mode	±99dot
20		Cutter mode	±99dot
21		Dispenser mode	±99dot

No.	Category	Setting item	Setting contents
22	RS-232C interface *1	Baud rate	9600/19200/38400bps
23		Data bit	7/8 bit
24		Parity	No parity/Odd number/Even number
25		Stop bit	1/2 bit
26		Control	READY/BUSY control (single item buffer), READY/BUSY control (multi buffer), Xon/Xoff, Protocol for driver(STATUS4), STATUS3
27	LAN interface *2	LAN mode	Protocol for driver(STATUS4)Cyclic response *3 Protocol for driver(STATUS4)ENQ response *3 1 port connection/ENQ response(STATUS3)
28	IEEE 1284 inter- face *4	Buffer type	Multi/ 1 item
		ACK width	010 to 200 (1=50ns)
28	Non-standard code	Nonstandard code switching	Standard code/Nonstandard code
29		Nonstandard code setting	Nonstandard code settings for STX, ETX, ESC, ENQ, CAN, NULL, OFFLINE
30	Download	Firmware download	Download firmware from the host computer.
31		Reboot mode *5	(1) Start up in program download mode (Available in normal operation mode only) (2) Start up in normal operation mode (Available in program download mode only)

*1. Available for USB+RS-232C specification only.

*2. Available for USB+LAN specification only.

*3. Use SATO port or Port 9100 when sending print request from the printer driver.

*4. Available for IEEE1284+USB specification only.

*5. The printer will restart in specified mode.

This page is intentionally left blank

4

TROUBLESHOOTING

If you are unable to produce printouts on the CG4 Series printer, use this section to make sure the basics have been checked, before deciding you are unable to proceed any further.

This section is divided into four parts:





- 4.1 Error signal troubleshooting
- 4.2 Troubleshooting table
- 4.3 Interface troubleshooting
- 4.4 Test print troubleshooting

4.1 ERROR SIGNAL TROUBLESHOOTING

The **ON LINE (POWER)** and **ERROR** indicators light or flash in different colors and patterns listed below to alert user that an error has occurred on the printer. [Indicator sequence (as shown from left to right): ○Off, ●Red light, ●Green light]

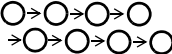
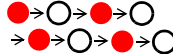
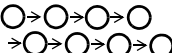
Contents	ON LINE (POWER) LED	ERROR LED	Buzzer	Causes	Corrective Actions
Hardware error					
FLASH ROM error	Off ○→○→○→○ →○→○→○→○	Solid red ●→●→●→● →●→●→●→●	1 long beep sound	1) FLASH ROM read/ write error. 2) Exceeded the FLASH ROM write count limits.	1), 2) Board replacement.
Setting information (FROM) error				1) FLASH ROM read/write error. 2) Exceeded the FLASH ROM write count limits.	1), 2) Board replacement.
Machine error				1) Board defect.	1) Board replacement.
Program error					
Incorrect program error	Off ○→○→○→○ →○→○→○→○	Solid red ●→●→●→● →●→●→●→●	—	1) Download did not complete successfully.	1) Download again.
Communication error					
Communication error by kit	Off ○→○→○→○ →○→○→○→○	[Red→Off] x twice →Red x twice→Off (blinks with changing interval)	1 long beep sound	Error contents may vary depending on the kit installed.	
Buffer over		●→○→●→○ →●→●→○→○		1) Received the amount of data exceeding the limit of receive buffer. 2) Wrong protocol.	1) Correct the software on the host side. 2) Set the correct protocol.
Download error					
Download error	Off ○→○→○→○ →○→○→○→○	Red x 4 times ->Off (longest blink interval) ●→●→●→● →○→○→○→○	1 long beep sound	1) Downloaded wrong data.	1) Download again.

4.1 ERROR SIGNAL TROUBLESHOOTING (Cont'd)

Contents	ON LINE (POWER) LED	ERROR LED	Buzzer	Causes	Corrective Actions
Minor error					
Cover open	Off	Blinking red	3 short beeps sound	1) Cover is not closed properly.	1) Close the cover.
Sensor error				1) Wrong sensor level. 2) Wrong sensor type. 3) Label meandering.	1) Level adjustment. 2) Sensor type adjustment.
Paper end				1) Out of paper.	1) Set the paper properly.
Ribbon end				1) Out of ribbon or ripped ribbon. 2) Ribbon is not set properly.	1) & 2) Set the ribbon properly.
Option					
Cutter error	Off	long blink interval	3 short beeps sound	1) Cutter is not connected. 2) Cut operation was not performed successfully.	1) Connect the cutter unit. 2) Set and feed the paper again.
					
Warning					
Buffer near full	Blinking green (Lights alternately)	Blinking red (Lights alternately)	—	1) Free space for receive buffer is low.	1) Pause the data transmission on the host side and wait to have enough buffer space.
Ribbon near end			—	1) Remaining amount of ribbon is little.	1) Ribbon replacement.

4.2 TROUBLESHOOTING TABLE

TRUBLESHOOTING TABLE	
NO POWER	
Printer does not turn on.	Power connector or AC adapter is not properly connected.
NO LABEL MOVEMENT	
Media is not set properly.	Set media and media guide correctly
Incorrect label sensor selected.	Set the sensor correctly by printer setting tool.
Dirty platen roller.	Clean the platen roller.
Damaged platen gear.	Replace platen roller and gear.
INCORRECT LABEL POSITIONING	
Incorrect label sensor selection.	Set the sensor correctly by printer setting tool.
Improper sensor adjustment.	Adjust sensor sensitivity as required.
Data input error.	Ensure correct data stream.
Incorrect offset settings.	Adjust settings as required by command.
NO PRINT MOTION	
The interface cable is not properly connected.	Connect the interface cable.
Interface problems.	Troubleshoot interface - refer to the next section.
Data input error.	Ensure correct data stream.
Defective main circuit board.	Have SATO authorised servicing personnel replace main board.
PRINTER CREATES A BLANK LABEL	
Data input error.	Ensure correct data stream.
Incorrect label sensor selection.	Set the sensor correctly by printer setting tool.
Print head is disconnected.	Power off the printer and ensure a proper connection.
Defective print head.	Replace print head as required.
Defective main circuit board.	Have SATO authorised servicing personnel replace main board.
IMAGE VOIDS	
Dirty print head.	Clean print head.
Defective print head.	Replace print head.
Defective main circuit board.	Have SATO authorised servicing personnel replace main board.
Damaged or worn platen roller.	Replace platen roller.
Poor label quality.	Use higher quality media. Use only SATO-certified media.
Ribbon stock and media are mismatched. *1	Consult with media supplier. Use only SATO-certified media.
RIBBON WRINKLING *1	
Damaged or worn platen roller.	Replace platen roller.
Foreign material on print head and/or platen roller.	Clean as required.
Foreign material on labels.	Use higher quality media. Use only SATO-certified media.
Defective print head.	Replace print head as required.

*1 Ribbon stock conditions are only applicable to CG408TT and CG412TT printers.

4.2 TROUBLESHOOTING TABLE (Cont'd)

TROUBLESHOOTING TABLE	
LIGHT PRINT IMAGES	
Low print head darkness.	Adjust darkness level setting.
Foreign material on print head.	Clean print head and platen roller.
Excessive print speed.	Reduce print speed setting.
UNEVEN PRINT DARKNESS	
Damaged or worn platen roller.	Replace platen roller.
Dirty print head.	Clean print head.
Defective print head.	Replace print head as required.
SMEARED PRINT IMAGES	
Poor media quality	Use higher quality media. Use only SATO-certified media.
Foreign material on print head and platen roller	Clean print head and platen roller.
Foreign material on labels	Use higher quality media. Use only SATO-certified media.
Excessive print head energy	Adjust darkness level setting.
Excessive print speed	Adjust print speed as required.
MEANDERING MEDIA	
Incorrectly loaded media.	Ensure correct loading.
Media is not set properly.	Set media and media guide correctly.
Damaged or worn platen roller.	Replace platen roller.

4.3 INTERFACE TROUBLESHOOTING

This chapter provides a checklist for the various interface types. Locate the checklist relative to the interface used and perform each of the troubleshooting tasks until the problem has been isolated.

UNIVERSAL SERIAL BUS (USB) INTERFACE

If nothing prints during a test print, verify the device drivers have been successively installed by performing the following:

CHK	TROUBLESHOOTING STEP
	Click on Start, Settings, and then Control Panel.
	Click on System within the new window.
	Click on the Device Manager tab.
	Ensure that the View Device By Type is checked.
	Scroll to SATO-USB Device and ensure that errors do not exist. Reinstall as required.
	Reboot the PC and the printer.

RS232 SERIAL INTERFACE

CHK	TROUBLESHOOTING STEP
	Ensure the correct interface module is correctly installed. Run self-test to verify.
	Ensure the serial cable (Null Modem) meets specifications and is correctly connected at each end.
	Ensure the serial cable is not defective.
	Ensure the communication parameters for the baud rate, parity, data bits and stop bits are consistent with those being sent from the host computer.
	Ensure the printer is receiving information from the computer using the Receive Buffer Hex Dump mode. Refer to that procedure within this manual for instructions. The command stream should be continuous and possess 0Dhex and/or 0Ahex (carriage return and line feed) characters throughout. However, there should not be either located between the start (<ESC>A) and the stop (<ESC>Z) commands.
	Try another port to isolate the problem.
	Replace the main circuit board if determined to be the problem.

LAN ETHERNET INTERFACE

CHK	TROUBLESHOOTING STEP
	Ensure the interface has been correctly configured. Wait two minutes and run self-test to verify. If a test label does not print, there may be a hardware problem.
	Ensure the cable and its ports are not defective.
	Ensure that a faulty print server or other protocol related scenarios are not creating a queue setup issue. Systematically perform checks and tests to isolate the cause.
	If using TCP/IP, ensure that a valid IP address is specified and that all parameters are correct (subnet mask, gateway, etc.). Attempt to PING the IP address assigned to the network interface.
	If using a repeater or hub, ensure the SQE is turned off. Also ensure the repeater port is not defective by trying the print server on another port.
	Install the IPX/SPX protocol on a workstation to determine if the network device can be discovered via the MAC address. If able, configure the appropriate protocols and retest connectivity.
	Use a crossover cable to isolate the printer from the network by connecting from the interface and workstation. Verify that the parameters match on each. Test connectivity.

4.3 INTERFACE TROUBLESHOOTING (Cont'd)

PARALLEL INTERFACE	
CHK	TROUBLESHOOTING STEP
	Ensure the interface module is correctly installed. Run self-test to verify.
	Ensure the printer cable is connected to the appropriate LPT port on the host computer. If using a Windows printer driver, ensure the correct port is selected.
	Ensure a IEEE1284 printer cable is being used.
	Ensure the host's peripheral settings are set to ECP for faster throughput. Refer to the computer manufacturer's documentation for details.
	Ensure the printer is receiving information from the computer using the Receive Buffer Hex Dump mode. Refer to that procedure within this manual for instructions. The command stream should be continuous and possess 0Dhex and/or 0Ahex (carriage return and line feed) characters throughout. However, there should not be either located between the start (<ESC>A) and the stop (<ESC>Z) commands.
	Try another port to isolate the problem.
	Replace the main circuit board if determined to be the problem.

CENTRONICS INTERFACE	
CHK	TROUBLESHOOTING STEP
	Ensure the interface module is correctly installed. Run self-test to verify.
	Ensure the printer cable is connected to the appropriate LPT port on the host computer. If using a Windows printer driver, ensure the correct port is selected.
	Ensure the host's peripheral settings are set for Centronics output for faster throughput. Refer to the computer manufacturer's documentation for details.
	Ensure the printer is receiving information from the computer using the Receive Buffer Hex Dump mode. Refer to that procedure within this manual for instructions. The command stream should be continuous and possess 0D Hex and/or 0A Hex (carriage return and line feed) characters throughout. However, there should not be either located between the start (<ESC>A) and the stop (<ESC>Z) commands.
	Replace the main circuit board with another to isolate the problem.

4.4 TEST PRINT TROUBLESHOOTING

This chapter provides instruction on special printing to identify and resolve specific print problems.

4.4.1 Hex Dump

Allows the operator to determine if there were problems in the downloading of data. The contents of the print buffer can be examined using the Hex Dump Mode. In the left column, each line of data received is numbered. The center column provides the data in hexadecimal format. And in the right column, the same data are provided in the ASC II format. Refer to **Section 3.9 HEX Dump Mode** for more details to perform this activity.

4.4.2 Test label printing

Allows the operator to identify specific problems regarding mechanical performance and setup. The test label is designed to assist in the identification of print problems. Refer to **Section 3.3 User Test Print Mode** for more details to perform this activity.

This page is intentionally left blank

5

CLEANING AND MAINTENANCE

This section provides information on user maintenance for the CG4 Series printer.

The following information is covered here:

- 5.1 Cleaning The Print Head, Platen and Rollers
- 5.2 How To Clean The Printer (Cleaning Kit)
- 5.3 How To Clean The Printer (Cleaning Sheet)
- 5.4 Easy Replacement of Parts
- 5.5 Adjusting Print Quality



Caution

- When cleaning the print head, bear in mind that the print head and its surroundings may be hot. Wait until the printer cools down before proceeding to clean the printer.
- Be sure to turn off the power before cleaning.
- The suggested cleaning schedules here are just guidelines. If necessary, clean as appropriate, depending on the degree of contamination.
- Use a cleaning pen, cotton swab or cotton cloth, from an approved cleaning kit, to clean the printer units.
- Use only soft, lint-free materials for cleaning. Avoid using hard objects for the cleaning process, as they will damage the components.

5.1 CLEANING THE PRINT HEAD, PLATEN AND ROLLERS

The print head not only generates printouts of barcodes, but also graphics and text. To produce optimal printing, it must be kept clean in spite of the dirt and adhesive that constantly accumulates on its print surface. Furthermore, dirt can accumulate along the label path, affecting parts like sensors and guides, and reducing their performance.

Therefore, it is important to clean these important components periodically. The printer cleaning kit and cleaning sheets can be purchased from your authorised SATO representative.

When to clean with a cleaning kit

- ◆ For the print head, platen roller, paper sensor, and label guide: clean after using up every other roll of media.
- ◆ For other parts: clean after finishing every six rolls of media.

When to clean with the cleaning sheet

- ◆ For print head: clean after using every six rolls of media, or when you find any burned glaze on the surface of the print head.

5.2 HOW TO CLEAN THE PRINTER (CLEANING KIT)

If you are using a carbon ribbon, be sure to remove it before cleaning. Follow the instructions supplied with the cleaning kit. Use the items to clean the following parts.

1. Before starting, get ready an approved cleaning kit from your SATO representative. Make sure the printer is powered off, and remove the power cable.
2. Lift the **Top Cover**.
3. Remove the media and the ribbon.

Cleaning the Print Head

4. Apply **Thermal Print Head Cleaner** to a cotton swab.
5. Locate the **Print Head Assembly** which is mounted under the Top cover. The **Print Head** faces downward along the front edge of the assembly. Press the end of the dampened swab along the entire width of the **Print Head**.
6. Check for any black coloring or adhesive on the swab after cleaning. Discard the dirty swabs.
7. Repeat, if necessary, until the swab is clean after it is pressed over the print head.



Cleaning the platen roller, sensor and label guide

8. The **platen roller** is the black rubber roller near the front panel. Wet some cotton swabs or cotton cloth with cleaning solution. While rotating the **platen roller** with your fingers (see arrow), clean the entire length of the roller using one or more cotton swabs. Wipe any dirt or accumulated adhesive off the **platen roller**.



5.2 HOW TO CLEAN THE PRINTER (CLEANING KIT) (cont'd)

9. Locate the **I-Mark sensor** and **Gap sensor** on the left **Media guide**.
10. Dab a cotton cloth with the same cleaning solution. Clean any foreign matter from the exposed surface of the media guides and sensor. Insert the cotton cloth in the slot of the media guide and briskly clean it with a back and forth motion.
11. Repeat the whole cleaning process when it is necessary. The **platen roller** should be cleaned whenever foreign matter, such as dust or adhesive, is present.

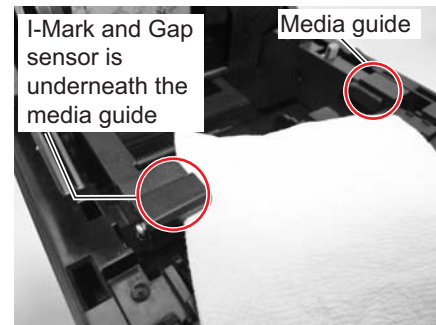

5.3 HOW TO CLEAN THE PRINTER (CLEANING SHEET)

If certain stains on the print head cannot be removed easily with cotton swabs dabbed in cleaning solution, the cleaning sheet is used for clearing such stubborn debris on the print head.

1. Make sure the printer is powered off and remove the power cable.
2. Lift the **Top Cover**.
3. Remove the media and the ribbon.
4. Place the head **cleaning sheet** between the **print head** and the **platen roller**. The coarse side of the **cleaning sheet** should face the surface of the **print head** elements.
5. Close the **top cover** with approximately 25mm (1 inch) of the **cleaning sheet** extended out of the printer.
6. Using both hands, slowly pull the exposed **cleaning sheet** outwards. This will remove any dirt stuck to the **print head**.
7. When the **cleaning sheet** has been removed, perform steps 2 to 6 to repeat the cleaning procedure one or two more times.
8. When no more additional dirt appears on the **cleaning sheet** after it has been pulled out, you can stop cleaning with the sheet.
9. Use the **cleaning pen** from the cleaning kit or use a cotton swab moistened with head cleaner to gently remove any remaining dirt from the **print head**.



5.4 EASY REPLACEMENT OF PARTS

It is easy to replace the print head and platen roller of the CG4 Series printer. The one-touch, tool-less print head release mechanism enables the print head to be quickly and easily replaced. The platen roller can be replaced without the need to use any tools.

5.4.1 Releasing/ Replacing the Print Head

The print head on the printer is a user-replaceable item. If it becomes damaged for any reason, it can be easily removed and replaced. Contact your local SATO representative for information on obtaining a new print head.



Caution

- Static electricity can result in component damage. Observe appropriate grounding procedures when replacing any components.
- Wear protective gloves to avoid contaminating the sensitive print head surface.

For CG412 DT and CG418 DT Direct Thermal printer

1. Make sure the printer is turned off, and remove the power cable.
2. Lift the **Top Cover**.
3. While pressing and hold down the top portion of the **print head assembly** (see arrow ①), slide the **side tab** (②) downward to unlock the print head assembly. Shift the **print head assembly** to the right and pull the whole **print head assembly** downward.
4. The **cable connectors** (circled) at the rear of the **print head** is now exposed. Pull the print head downward, then gently disconnect the defective **print head** from the cable connectors.
5. Carefully connect the **cable connectors** to a replacement **print head**. The **white cable** should be connected to the **left connector** while **black cable** should be connected to the **right connector**. The connectors are keyed so that they can only be inserted in the correct orientation.

Caution:

While handling the **print head**, be careful not to scratch the printing surface of the **print head**. Scratching the surface will cause permanent and irreparable damage that is not covered by the warranty!

6. Insert the **left shaft** of the new **print head assembly** into the hole beside the triangular symbol on the left side of printer. (see circled area).

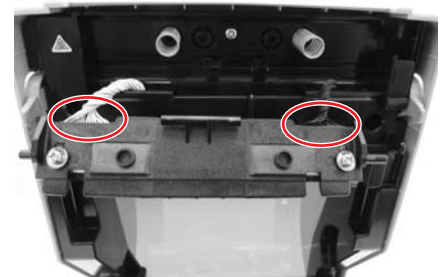
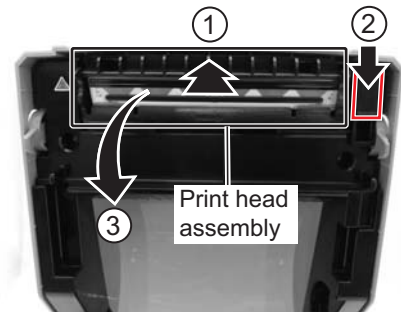

5.4 EASY REPLACEMENT OF PARTS (cont'd)

7. Align the two **circular recess** of the **print head bracket** to the two **springs** attached to the **top cover frame**. At the same time, fix the **fulcrum shaft** of the **print head bracket** to the **hooks**. While pressing the **print head**, slide the **side tab** upwards to lock the **print head assembly** in place.
8. Close the **Top Cover**.
9. Restore power, reload media, reset the head counter and perform a test print to ensure that the **print head** is connected properly.

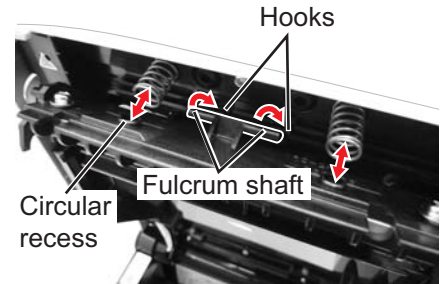

For CG212 TT and CG218 TT Thermal transfer printer

1. Make sure the printer is turned off, and remove the power cable.
2. Lift the **Top Cover**.
3. Pull the **lever** on the middle of the **ribbon unit** downward to pull out the **ribbon unit**. Then, simply let down the **ribbon unit**. There is a stopper midway through its movement range that will prevent the ribbon unit from snapping down.
4. On the right side of the **ribbon unit**, slide the **print head release lever** (1) to unlock the **print head assembly**. Move the whole **print head assembly** downward.

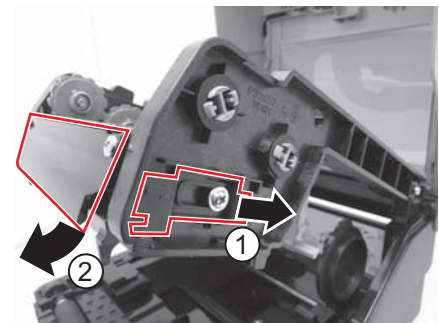
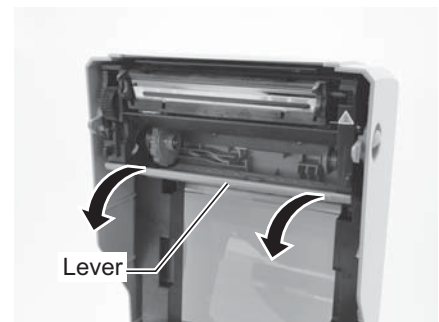

5. The **cable connectors** (circled) at the rear of the **print head** is now exposed. Pull the **print head** downward, then gently disconnect the defective **print head** from the cable connectors.
6. Carefully connect the **cable connectors** to a replacement **print head**. The **white cable** should be connected to the **left connector** while **black cable** should be connected to the **right connector**. The connectors are keyed so that they can only be inserted in the correct orientation.

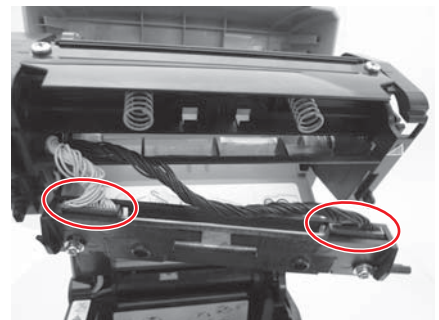

Caution:

While handling the **print head**, be careful not to scratch the printing surface of the **print head**. Scratching the surface will cause permanent and irreparable damage that is not covered by the warranty!

5.4 EASY REPLACEMENT OF PARTS (cont'd)

7. Insert the **left shaft** of the new **print head assembly** into the hole on the left side of printer. (see circled area).

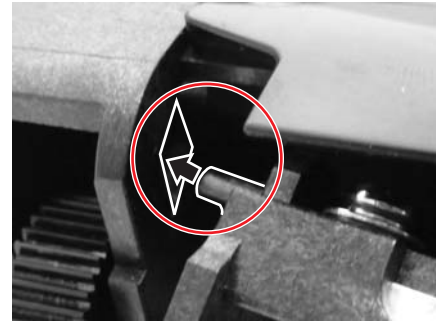

8. Align the two **circular recess** of the **print head bracket** to the two **springs** attached to the **top cover frame**. At the same time, fix the **fulcrum shaft** of the **print head bracket** to the **hooks**. While pressing the **print head**, slide the **print head release lever** to lock the **print head assembly** in place.
9. Restore power, reload media and ribbon, reset the head counter and perform a test print to ensure that the **print head** is connected properly.

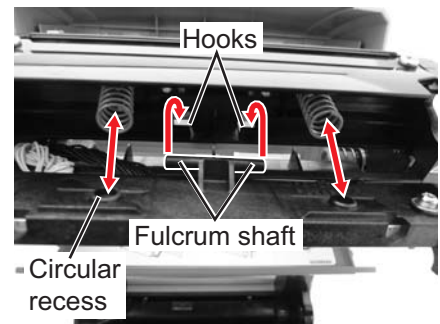

5.4.2 Releasing/ Replacing the Platen roller

1. Make sure the printer is powered off and remove the power cable.
2. Lift the **Top Cover**.
3. Locate the two **platen bearings** on each side of the **platen roller**, and turn the handles in the direction as shown.
4. Lift up the defective **platen roller** assembly with the handles and replace it with a new one.
5. Follow the above steps, in reverse sequence, to reassemble the parts. Make sure that the **platen bearing** snaps back in position. Perform a label feed to ensure the **platen roller** is assembled correctly.

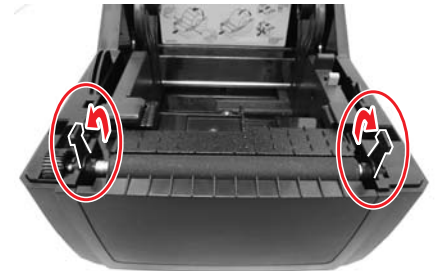

5.5 ADJUSTING PRINT QUALITY

Print quality can be optimized with regular cleaning and maintenance of the print head and components along the label path. Additionally, you can fine-tune print quality by adjusting print darkness and print speed settings.

When adjusting the printer for optimum print quality, a barcode verifier system is highly recommended for evaluating the printouts. The human eye is a poor judge of the relative widths of the bars in a symbol, a characteristic that is extremely important for good barcode quality.

Print Darkness

This adjustment allows the user to control (within a specified range) the amount of power that is used to activate the print head heating elements. It is important to find a proper print darkness level based on your particular label. The printed images should not be too light nor should the edges of text or graphics be smudged. Instead, the edges of each image should be crisp and well defined. The adjustment can be made via standard SBPL commands or by the Utilities Tool application. For more information refer to the SBPL Programming Reference.

Print Speed

The other method of controlling print quality is by controlling the speed at which the label is printed. It is especially critical when printing “ladder” barcodes (barcodes printed with the bars parallel to the print line). When printing a “ladder” barcode, it is important to allow the head to cool sufficiently before stepping to the next position. If it does not have sufficient time to cool, the bar will be “smeared” on the trailing edge. The adjustment can be made via standard SBPL commands or by the Utilities Tool application. For more information refer to the SBPL Programming Reference.

This page is intentionally left blank

6

GENERAL SPECIFICATIONS

6.1 PRINTER BASIC SPECIFICATIONS

MODEL NAME	CG408 DT	CG412 DT	CG408 TT	CG412 TT
------------	----------	----------	----------	----------

PHYSICAL CHARACTERISTICS	
Width	7.05" (179 mm)
Depth	9.37" (238 mm)
Height	6.81" (173 mm)
Weight	3.7 lbs. (1.7 kg) 4.19 lbs. (1.9 kg)

POWER SUPPLY (AC ADAPTER)	
Input Voltage	100-240 V AC, +/-10%, 50/60 Hz (Full range)
Output Voltage	19 V DC, +/-5%, 3.86A
Power Consumption	At peak times: 50 Watts During standby: 2.5 Watts

ENVIRONMENTAL (EXCLUDING MEDIA)	
Operating Temperature	39.2 to 100.4°F (4° to 38°C)
Storage Temperature	14 to 140°F (-10° to 60°C)
Operating Humidity	30 to 80% RH, Non-condensing
Storage Humidity	15 to 85% RH, Non-condensing

PRINT				
Method	DT models: Direct Thermal only		TT models: Thermal Transfer and Direct Thermal	
Print Speed (selectable)	2, 3 or 4 Inches/second (Setting: 2, 3, 4) (50, 75 or 100 mm/second) *Maximum print speed varies depending on the of media used.			
Resolution	(203 Dots Per Inch) 8 dots/mm	(305 Dots Per Inch) 12 dots/mm	(203 Dots Per Inch) 8 dots/mm	(305 Dots Per Inch) 12 dots/mm
Maximum Print Width	4.09" (104 mm)			
Maximum Print Length	11.81" (300 mm)			

Section 6: General Specifications

MODEL NAME	CG408 DT/ CG408TT	CG412 DT/ CG412TT
MEDIA (BE SURE TO USE MEDIA MANUFACTURED OR CERTIFIED BY SATO)		
Type	Direct Thermal / Thermal Transfer depending on print model (DT or TT) Roll stock or Fan-fold	
Wind Direction	Roll stock: Face In or Face out winding	
Roll and Core Diameter	Maximum outer diameter: 5.04" (128 mm) with Inner core diameter: 1.5" (40 mm) * Inner core diameter: 0.75" (19.05 mm) with maximum outer diameter: 4.33" (110 mm) can be accepted, but there is no performance guarantee.	
Fanfold Max. stack height	4.65" (118 mm) (external supply)	
Size	<p>Label</p> <p>Continuous Pitch: 0.27" to 11.8" (7 to 300 mm) Pitch including liner: 0.39" to 11.93" (10 to 303 mm) Width: 0.86" to 4.21" (22 to 107 mm) Width including liner: 0.98" to 4.33" (25 to 110 mm)</p> <p>Cutter Pitch: 0.87" to 11.8" (22 to 300 mm) Pitch including liner: 0.98" to 11.93" (25 to 303 mm) Width: 0.87" to 4.21" (22 to 107 mm) Width including liner: 0.98" to 4.33" (25 to 110 mm)</p> <p>Dispenser Pitch: 0.87" to 3.93" (22 to 100 mm) Pitch including liner: 0.98" to 4.05" (25 to 103 mm) Width: 0.87" to 4.21" (22 to 107 mm) Width including liner: 0.98" to 4.33" (25 to 110 mm)</p> <p>Tear-off Pitch: 0.87" to 11.8" (22 to 300 mm) *¹ Pitch including liner: 0.98" to 11.93" (25 to 303 mm) Width: 0.87" to 4.21" (22 to 107 mm) Width including liner: 0.98" to 4.33" (25 to 110 mm)</p> <p>Linerless Pitch: 0.98" to 3.93" (25 to 100 mm) *¹ Width: 0.98" to 4.33" (25 to 110 mm)</p> <p>Non-adhesive paper</p> <p>Continuous Pitch: 0.39" to 11.93" (10 to 303 mm) *¹ Width: 0.98" to 4.33" (25 to 110 mm)</p> <p>Cutter Pitch: 0.98" to 11.93" (25 to 303 mm) Width: 0.98" to 4.33" (25 to 110 mm)</p> <p>Tear-off Pitch: 0.98" to 11.93" (25 to 303 mm) *¹ Width: 0.98" to 4.33" (25 to 110 mm)</p>	
	<p>*¹ When using media with small pitch, you must tear it by hand.</p> <ul style="list-style-type: none"> • The above size may be limited by use conditions, such as type of paper, usage environment, and application. • When using the dispenser mode, restrictions apply to the maximum paper length according to paper installation conditions. 	
Thickness	0.0024" to 0.0074" (0.06 to 0.19 mm)	

MODEL NAME	CG408 DT	CG412 DT	CG408 TT	CG412 TT
------------	----------	----------	----------	----------

RIBBON (BE SURE TO USE RIBBON MANUFACTURED OR CERTIFIED BY SATO)		
Wind Direction	—	Face Out
Winding Method		Paper core
Roll Diameter		Maximum outer diameter: 1.4" (38 mm)
Core Diameter		Inner core diameter: 0.5" (12.7 mm)
Length		Max. 328 ft. (100 m). Do not exceed the maximum outer diameter.
Width		Use only 4.33" +/- 0.01" (110 mm +/- 0.5 mm)

PROCESSING	
CPU	32 Bit RISC-CPU 133 MHz
Flash ROM	4 Megabytes
SDRAM	8 Megabytes

PRINTER LANGUAGE	
Standard	SATO Barcode Printer Language (SBPL)

INTERFACES	
Standard Configurations	<p>Select one of the following. (The factory will provide the unit with the selected interface.)</p> <p>1) USB 2.0 (Type B) with RS-232C (D-SUB 9-pin type) or 2) USB 2.0 (Type B) with LAN (10BASE-T/100BASE-TX Automatic Switching) or 3) USB 2.0 (Type B) with IEEE1284</p> <p>*The RS-232C connector can be used to connect the printer to a computer, an optional keypad, Smart keyboard or Barcode scanner.</p>

SENSING		
Gap (Transmissive)	Sensitivity Adjustable	
I-Mark (Reflective)	Sensitivity Adjustable	
Cover Open	Fixed	
Ribbon End	Not available	Fixed (Only available for Thermal Transfer model)
Dispenser	Fixed (Only available if installed)	
Linerless label sensor	Fixed (Only available if installed)	

LABEL ISSUING MODES	
	Standard: Continuous mode, Tear-off mode, Sensor off mode
	Optional mode: Dispenser mode, Cutter mode, Linerless (Nonsepa) mode

MODEL NAME	CG408 DT	CG412 DT	CG408 TT	CG412 TT
------------	----------	----------	----------	----------

SELF-DIAGNOSIS		
	Cover Open Detection Paper End Detection Test Print Cutter error (Only available if installed)	Cover Open Detection Paper Detection Test Print Ribbon end Detection Cutter error (Only available if installed)

CHARACTER FONT CAPABILITIES				
BITMAP FONTS				
U	5 dots W x 9 dots H (Alphanumeric characters and symbols)			
S	8 dots W x 15 dots H (Alphanumeric characters and symbols)			
M	13 dots W x 20 dots H (Alphanumeric characters and symbols)			
WB	18 dots W x 30 dots H (Alphanumeric characters and symbols)			
WL	28 dots W x 52 dots H (Alphanumeric characters and symbols)			
XU	5 dots W x 9 dots H (Alphanumeric characters and symbols)			
XS	17 dots W x 17 dots H (Alphanumeric characters and symbols)			
XM	24 dots W x 24 dots H (Alphanumeric characters and symbols)			
XB	48 dots W x 48 dots H (Alphanumeric characters and symbols)			
XL	48 dots W x 48 dots H (Alphanumeric characters and symbols)			
OA Font (OCR-A)	15 dots x 22 dots (Alphanumeric characters and symbols)	22 dots x 33 dots (Alphanumeric characters and symbols)	15 dots x 22 dots (Alphanumeric characters and symbols)	22 dots x 33 dots (Alphanumeric characters and symbols)
OB Font (OCR-B)	20 dots x 24 dots (Alphanumeric characters and symbols)	30 dots x 36 dots (Alphanumeric characters and symbols)	20 dots x 24 dots (Alphanumeric characters and symbols)	30 dots x 36 dots (Alphanumeric characters and symbols)
KANJI FONTS				
	Supported by downloading one of the following Kanji fonts. 1) Simplified Chinese (2.6 MB) Gothic type GB2312 (24 x 24 dot) 2) Korean (1.6 MB) Gothic type KSX1001 (16 x 16 dot) Mincho type KSX1001 (24 x 24 dot)			
OUTLINE FONTS				
	Alphanumeric characters and symbols			
CHARACTER CONTROL				
Magnification	Expansion up to 12 x in either the vertical or horizontal			
Rotation	0°, 90°, 180° and 270°			

MODEL NAME	CG408 DT	CG412 DT	CG408 TT	CG412 TT
------------	----------	----------	----------	----------

BARCODE CAPABILITIES	
Linear Bar Codes	UPC-A/UPC-E, EAN8/13, CODE39, CODE93, CODE128, GS1-128 (UCC/EAN128), CODABAR(NW-7), ITF, Industrial 2 of 5, Matrix 2 of 5, BOOKLAND, MSI, POSTNET, GS1 DataBar (RSS) * GS1 DataBar is new version of RSS-14.
Two Dimensional codes	PDF417 (Ver.2.4), MAXI code (Ver.3.0), QR code, GS1 DataMatrix (ECC200)
Composite Symbols	EAN-13 Composite (CC-A/CC-B) EAN-8 Composite (CC-A/CC-B) UPC-A Composite (CC-A/CC-B) UPC-E Composite (CC-A/CC-B) GS1-128 Composite (CC-A/CC-B/CC-C) GS1 DataBar Composite (CC-A/CC-B) GS1 DataBar Truncated Composite (CC-A/CC-B) GS1 DataBar Stacked Composite (CC-A/CC-B) GS1 DataBar Stacked Omni-Directional Composite (CC-A/CC-B) GS1 DataBar Limited Composite (CC-A/CC-B) GS1 DataBar Expanded Composite (CC-A/CC-B) GS1 DataBar Expanded Stacked Composite (CC-A/CC-B) * GS1 DataBar is new version of RSS-14.
Ratios	1:2, 1:3, 2:5, User definable bar widths
Magnification	1 x to 12 x
Rotation	Parallel 1 (0°), Parallel 2 (180°), Serial 1 (90°) and Serial 2 (270°)

STANDARD FUNCTIONS	
	<ol style="list-style-type: none"> 1) Status return function 2) Graphic function 3) Sequential number function 4) Form overlay function 5) Custom character registration function 6) Black/white inversion function 7) Ruled line function 8) Format registration function 9) Zero slash switching function

Section 6: General Specifications

MODEL NAME	CG408 DT	CG412 DT	CG408 TT	CG412 TT
-------------------	----------	----------	----------	----------

HARDWARE AND RELATED	
Operation keys	POWER and FEED/LINE buttons
Indicators	ON LINE (POWER): Green LED ERROR: Red LED
Buzzer	Built-in buzzer • On/ off switchable buzzer (specified by command) • No volume control function available

OPTIONS	
	1) Cutter Unit 2) Dispenser Unit 3) RTC kit (Calendar IC) 4) Linerless (Nonsepa) Unit 5) Keypad* 6) Compatible smart keyboard* 7) Compatible 1D barcode scanner* *Applicable to USB and RS232C interface model only. Connect to RS232C terminal.

REGULATORY COMPLIANCE	
Safety regulation	UL60950-1(2001) (USA) CSA22.2 No.60950-1-30 (Canada) EN60950-1, CE (Europe) CCC (GB4943-2001) (China)
EMC regulation	FCC15B Class B (USA/Canada) CE (EN55022, EN55024) (Europe) GB9254-1998, GB17625.1(2003) (China) KN22, KN24 (Korea)
Packing Drop Standard	ISTA-2A
Environmental (RoHS)	Chromium: below 0.1% Lead: below 0.1% Mercury: below 0.1% Cadmium: below 0.01% Polybrominated Biphenyl (PBB): below 0.1% Polybrominated Diphenyl Ether (PBDE): below 0.1%

6.2 OPTIONAL ACCESSORIES SPECIFICATIONS

CUTTER SPECIFICATIONS	
Media Type	Non-adhesive paper and Label
Media Size	Pitch: 0.87" to 11.8" (22 to 300 mm) Pitch including liner: 0.98" to 11.93" (25 to 303 mm) Width: 0.87" to 4.21" (22 to 107 mm) Width including liner: 0.98" to 4.33" (25 to 110 mm)
Thickness	0.0024" to 0.0074" (0.06 to 0.19) mm
Self-diagnosis function	Cutter error detection
Durability	More than 300,000 cuts

DISPENSER SPECIFICATIONS	
Media Type	Label only * Some restrictions may apply to some label types depending on the substrate, adhesive, paper size, and environment. Refer to SATO representative on the labels to be used. * Perforated liner and split liner cannot be used. * Peel end labels
Media Size	Pitch: 0.86" to 3.93" (22 to 100 mm) Pitch including liner: 0.98" to 4.05" (25 to 103 mm) Width: 0.86" to 4.21" (22 to 107 mm) Width including liner: 0.98" to 4.33" (25 to 110 mm)
Thickness	0.0024" to 0.0074" (0.06 to 0.19) mm
Sensor Type	Dispenser sensor (Reflective type)

LINERLESS (NONSEPA) KIT SPECIFICATIONS	
Media Type	Micro-perforated Linerless (Nonsepa) Label
Media Size	Pitch: 0.98" to 3.93" (25 to 100 mm) Width: 0.98" to 4.33" (25 to 110 mm)
Thickness	0.0024" to 0.0074" (0.06 to 0.19) mm
Media Winding direction	Face-out
Roll and core Diameter	Maximum outer diameter: 5.04" (128 mm) with Inner core diameter: 1.5" (40 mm)
Sensor Type	Label sensor (Reflective type)
Label issuing mode	Continuous mode, Tear-off mode

This page is intentionally left blank

7

INTERFACE SPECIFICATIONS

This section presents the interface types and their specifications for the CG4 Series printers. These specifications include detailed information to assist in the selection of the most appropriate method for the printer to interface with the host.

The following information is presented in this section:

- 7.1 Interface types
- 7.2 RS232C Serial Interface
- 7.3 IEEE 1284 Parallel Interface
- 7.4 Universal Serial Bus (USB) Interface
- 7.5 Local Area Network (LAN) Ethernet

7.1 INTERFACE TYPES

The CG4 Series has three types of Main PCBs. Each type of PCB is equipped with two different interface types for performing data communication with the host. These are described as follows.

- 1) **Type 1:** USB and LAN on-board
- 2) **Type 2:** USB and RS232C on-board
- 2) **Type 3:** USB and IEEE1284 on-board

Model	Interface Types			
	USB	LAN	RS232C	IEEE1284
CG4 series (Type 1)	Yes	Yes	-	-
CG4 series (Type 2)	Yes	-	Yes	-
CG4 series (Type 3)	Yes	-	-	Yes

Caution

Never connect or disconnect interface cables (or use a switch box) with power applied to either the host or printer. This may caused damage to the interface circuitry in the printer/ host and is not covered by warranty.

7.2 RS232C SERIAL INTERFACE

7.2.1 Basic Specifications of RS-232C Serial Interface



This interface complies with the RS-232C standard.

Interface connector	 <p>DB-9S or equivalent (Male) Cable length: 5m or less</p>																																												
Communication settings	<p>Use Printer configuration tool or <I2> command to setup. <I2>abcde</p> <table border="1" data-bbox="545 816 1377 1719"> <thead> <tr> <th>Parameter</th> <th>Item</th> <th>Value</th> <th>Description</th> </tr> </thead> <tbody> <tr> <td rowspan="3">a</td> <td rowspan="3">Baud rate</td> <td>2</td> <td>38400bps</td> </tr> <tr> <td>1</td> <td>19200bps [Default]</td> </tr> <tr> <td>0</td> <td>9600bps</td> </tr> <tr> <td rowspan="2">b</td> <td rowspan="2">Data bit length</td> <td>1</td> <td>7 bits</td> </tr> <tr> <td>0</td> <td>8 bits [Default]</td> </tr> <tr> <td rowspan="3">c</td> <td rowspan="3">Parity bits</td> <td>2</td> <td>EVEN</td> </tr> <tr> <td>1</td> <td>ODD</td> </tr> <tr> <td>0</td> <td>NONE [Default]</td> </tr> <tr> <td rowspan="2">d</td> <td rowspan="2">Stop bits</td> <td>1</td> <td>2 bits</td> </tr> <tr> <td>0</td> <td>1 bit [Default]</td> </tr> <tr> <td rowspan="5">e</td> <td rowspan="5">Protocol</td> <td>4</td> <td>STATUS 3</td> </tr> <tr> <td>3</td> <td>Protocol for driver (STATUS 4) [Default]</td> </tr> <tr> <td>2</td> <td>XON/XOFF</td> </tr> <tr> <td>1</td> <td>READY/BUSY (Multi item buffer)</td> </tr> <tr> <td>0</td> <td>READY/BUSY (Single item buffer)</td> </tr> </tbody> </table>	Parameter	Item	Value	Description	a	Baud rate	2	38400bps	1	19200bps [Default]	0	9600bps	b	Data bit length	1	7 bits	0	8 bits [Default]	c	Parity bits	2	EVEN	1	ODD	0	NONE [Default]	d	Stop bits	1	2 bits	0	1 bit [Default]	e	Protocol	4	STATUS 3	3	Protocol for driver (STATUS 4) [Default]	2	XON/XOFF	1	READY/BUSY (Multi item buffer)	0	READY/BUSY (Single item buffer)
Parameter	Item	Value	Description																																										
a	Baud rate	2	38400bps																																										
		1	19200bps [Default]																																										
		0	9600bps																																										
b	Data bit length	1	7 bits																																										
		0	8 bits [Default]																																										
c	Parity bits	2	EVEN																																										
		1	ODD																																										
		0	NONE [Default]																																										
d	Stop bits	1	2 bits																																										
		0	1 bit [Default]																																										
e	Protocol	4	STATUS 3																																										
		3	Protocol for driver (STATUS 4) [Default]																																										
		2	XON/XOFF																																										
		1	READY/BUSY (Multi item buffer)																																										
		0	READY/BUSY (Single item buffer)																																										

7.2 RS232C SERIAL INTERFACE (cont'd)

Function descriptions

Function	Description
Baud rate setting	Select the data rate (bps) for the RS232 port.
Data bit length	Sets the printer to receive either 7 or 8 bits of data for each byte transmitted.
Parity setting	Selects the type of parity used for error detection.
Stop bit setting	Selects the number of stop bits to end each byte transmission.
Protocol setting	Selects the flow control and status reporting protocols

Synchro system	Asynchronous method														
Maximum receive buffer capacity	<p>1MB</p> <p style="text-align: center;">0MB 1MB</p> <p>Buffer near full occurred  Remaining 0.25MB</p> <p>Buffer near full released  Remaining 0.5MB</p>														
Code	ASCII (7 bits), Graphic (8 bits)														
Transmission form	<table border="1" style="margin-left: auto; margin-right: auto;"> <tr> <td>Start</td> <td>b1</td> <td>b2</td> <td>b3</td> <td>b4</td> <td>b5</td> <td>b6</td> <td>b7</td> <td>b8</td> <td>Stop</td> </tr> </table> <p>[Note] If using 7 bits, b8 will be omitted.</p>	Start	b1	b2	b3	b4	b5	b6	b7	b8	Stop				
Start	b1	b2	b3	b4	b5	b6	b7	b8	Stop						
Signal level	High level : +5 to +12V Low level : -5 to -12V														
Interface type	<p>Use Printer configuration tool or <DI> command. <DI>a</p> <table border="1" style="margin-left: auto; margin-right: auto;"> <thead> <tr> <th>Parameter</th> <th>Item</th> <th>Value</th> <th>Description</th> </tr> </thead> <tbody> <tr> <td rowspan="4" style="text-align: center;">a</td> <td rowspan="4" style="text-align: center;">Interface selection</td> <td style="text-align: center;">0</td> <td style="text-align: center;">USB</td> </tr> <tr> <td style="text-align: center;">1</td> <td style="text-align: center;">RS-232C</td> </tr> <tr> <td style="text-align: center;">2</td> <td style="text-align: center;">Keypad</td> </tr> <tr> <td style="text-align: center;">3</td> <td style="text-align: center;">Scanner/ Smart keyboard</td> </tr> </tbody> </table>	Parameter	Item	Value	Description	a	Interface selection	0	USB	1	RS-232C	2	Keypad	3	Scanner/ Smart keyboard
Parameter	Item	Value	Description												
a	Interface selection	0	USB												
		1	RS-232C												
		2	Keypad												
		3	Scanner/ Smart keyboard												

7.2 RS232C HIGH SPEED SERIAL INTERFACE (cont'd)

7.2.2 Ready/Busy

This protocol controls the reception of print data only by the control of hardware signal. Use the command <I2> to toggle between single item buffer and multi item buffer.

When the print data (STX ESC+"A"~ ESC+"Z" ETX) is sent from the host in the conditions below, received data may be incorrect.

- 1) When the printer is Offline
- 2) When an error has occurred in the printer

Pin Assignments

1) Host with DB-25P terminal

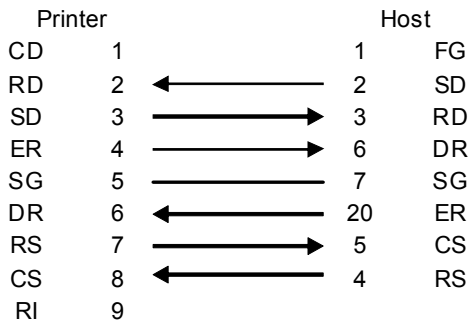

2) Host with DB-9P terminal

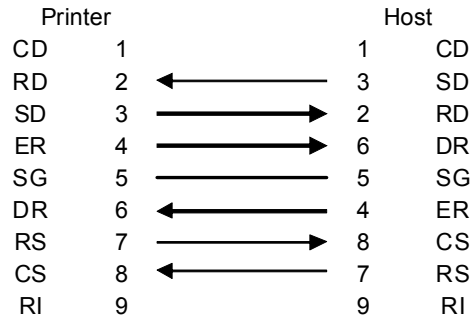

Interface Signals

Pin no.	Signal Type	Direction	Description
2	RD	Input	Data transferred from the host to the printer
3	SD	Output	Data transferred from the printer to the host
4	ER	Output	Data terminal READY
5	SG	-	Signal ground
6	DR	Input	Data set READY
7	RS	Output	Send request
8	CS	Input	READY to send

Notes:

Follow the procedures below when executing READY/BUSY control.

- 1) When the host sends the data for printing labels, make sure that the printer is on.
- 2) Turning the printer on after the printer receives a request from the host to print labels may cause the printer not to print the first print data (approximately 120 bytes).

To avoid this problem, it is necessary to attach approximate 120 bytes of dummy data by application software that enables the host to send the data for printing labels.

For example: When sending [STX+<A>+<V>20+<H>20+<P>2+<L>0202+<X20>, 1234+<Q>2+<Z>+ETX], transfer the appropriate 120 bytes of dummy data shown below.

[00H+00H+ ~ +00H+00H+00H+00H] + [STX ~ ETX]

7.2 RS232C HIGH SPEED SERIAL INTERFACE (cont'd)

7.2.3 X-ON/X-OFF

This transmission protocol informs the host if the printer is ready to receive data, by sending the "XON" (Hex 11H) or "XOFF" (Hex 13H) code.

When the print data (STX ESC+"A"~ ESC+"Z" ETX) is sent from the host in the conditions below, received data may be incorrect.

- 1) When the printer is Offline
- 2) When an error has occurred in the printer

Pin Assignments

1) Host with DB-25P terminal

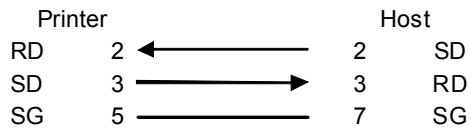

2) Host with DB-9P terminal

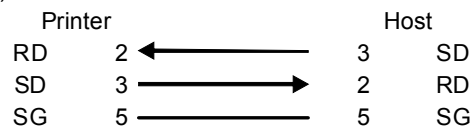

Note:

Depending on the host used, it may need to loop CS and RS (maintaining at "High" level) on the host side. Therefore, make sure to re-check the host before use.

Input/Output Signals

Pin no.	Signal Type	Direction	Description
2	RD	Input	Data transferred from the host to the printer
3	SD	Output	Data transferred from the printer to the host
5	SG	-	Signal ground

7.2.4 Return Status (STATUS 3 and Protocol for Driver (STATUS 4))

The purpose of these protocols is to control printer status on the host side. With the request command from the host, the status is returned from the printer.

After receiving the request command, the status is returned immediately.

In these communication protocols, receive mode is set to multi item buffer.







When the print data (STX ESC+"A"~ ESC+"Z" ETX) is sent from the host in the conditions below, received data may be incorrect.

- 1) When the printer is Offline
- 2) When an error has occurred in the printer

7.3 IEEE 1284 PARALLEL INTERFACE

7.3.1 Basic Specifications of IEEE1284 parallel interface

This interface complies with the Centronics/ IEEE1284 standard.
 ECP mode is recommended for LPT1 port.
 LPT1 port details can be set through a computer's BIOS settings.

Interface connector	 <p>Printer side: Amphenol (DDK) 57 to 40360 or equivalent Cable side: Amphenol (DDK) 57 to 30360 or equivalent Cable length: 1.5m or less</p>										
Signal level	High level : +2.4 to +5.0V Low level : +0.0 to +0.4V										
Communication condition setting	Use the <l1> command for the following settings. <table border="1" data-bbox="537 940 1000 1123"> <thead> <tr> <th>Item</th> <th>Color</th> </tr> </thead> <tbody> <tr> <td>Receive mode</td> <td>Single item buffer Multi item buffer</td> </tr> <tr> <td>ACK width</td> <td>010 to 200 (1=50ns)</td> </tr> </tbody> </table> <p>Communication protocol cannot be fixed at compatible mode because of IEEE1284 negotiation.</p>	Item	Color	Receive mode	Single item buffer Multi item buffer	ACK width	010 to 200 (1=50ns)				
Item	Color										
Receive mode	Single item buffer Multi item buffer										
ACK width	010 to 200 (1=50ns)										
Interface type	Use Printer configuration tool or <DI> command. <DI>a <table border="1" data-bbox="537 1283 1386 1438"> <thead> <tr> <th>Parameter</th> <th>Item</th> <th>Value</th> <th>Description</th> </tr> </thead> <tbody> <tr> <td rowspan="2">a</td> <td rowspan="2">Interface</td> <td>0</td> <td>USB</td> </tr> <tr> <td>1</td> <td>IEEE1284</td> </tr> </tbody> </table>	Parameter	Item	Value	Description	a	Interface	0	USB	1	IEEE1284
Parameter	Item	Value	Description								
a	Interface	0	USB								
		1	IEEE1284								
Maximum receive buffer capacity	1MB <table data-bbox="516 1539 1380 1759"> <tr> <td></td> <td style="text-align: center;">0MB</td> <td style="text-align: right;">1MB</td> </tr> <tr> <td>Buffer near full occurred</td> <td colspan="2">  </td> </tr> <tr> <td>Buffer near full released</td> <td colspan="2">  </td> </tr> </table>		0MB	1MB	Buffer near full occurred			Buffer near full released			
	0MB	1MB									
Buffer near full occurred											
Buffer near full released											
DeviceID	CG408 "MFG:SATO;CMD:PCL,MPL;MDL:CG408;" CG412 "MFG:SATO;CMD:PCL,MPL;MDL:CG412;"										

7.3 IEEE 1284 PARALLEL INTERFACE (cont'd)

7.3.2 Pin Assignments

Pin assignment of each signal for the Centronics standard (Compatible Mode) is as follows. Note that the connection of the IEEE1284 standard complies with the IEEE1284-B standard.

PIN No.	Signal	I/O	PIN No.	Signal	I/O
1	$\overline{\text{STROBE}}$	Input	19	STROBE-RETURN	
2	DATA 1	Input	20	DATA 1-RETURN	
3	DATA 2	Input	21	DATA 2-RETURN	
4	DATA 3	Input	22	DATA 3-RETURN	
5	DATA 4	Input	23	DATA 4-RETURN	
6	DATA 5	Input	24	DATA 5-RETURN	
7	DATA 6	Input	25	DATA 6-RETURN	
8	DATA 7	Input	26	DATA 7-RETURN	
9	DATA 8	Input	27	DATA 8-RETURN	
10	$\overline{\text{ACK}}$	Output	28	ACK -RETURN	
11	BUSY	Output	29	BUSY -RETURN	
12	PE	Output	30	PE -RETURN	
13	SELECT	Output	31	$\overline{\text{INIT}}$	Input
14	$\overline{\text{AUTOFD}}$	Input	32	$\overline{\text{FAULT}}$	Output
15			33		
16	LOGIC GND		34		
17	CHASSIS GND		35		
18	PERIPHERAL LOGIC HIGH	Output	36	$\overline{\text{SELECTIN}}$	Input

7.3 IEEE 1284 PARALLEL INTERFACE (cont'd)

7.3.3 Input/Output Signals

The details of each signal line for the Centronics standard (Compatible Mode) are as follows.
Note that each signal line complies with the IEEE1284 standard.



Signal	I/O	Description
STROBE	Input	Synchronization signal that requires low active pulse to read DATA1 ~ DATA8
DATA 1 ~ DATA 8	Input	Data entry of 8bits parallel: DATA1 --LSB (lowest bit) DATA8 --MSB (highest bit)
$\overline{\text{ACK}}$	Output	Low active pulse signal indicating the completion of receive data import
BUSY	Output	High active signal indicating that the printer is not ready to receive data
PE	Output	High active signal indicating paper shortage
SELECT	Output	High active signal indicating that the printer is ready to receive data
$\overline{\text{AUTOFD}}$	Input	Signal for the IEEE1284 standard
CHASSIS GND		Connecting to framework ground
PERIPHERAL LOGIC HIGH	Output	+5V voltage on the printer side
SIGNAL GND		Connecting to each signal ground
$\overline{\text{INIT}}$	Input	Low active pulse signal requesting to reset the printer
$\overline{\text{FAULT}}$	Output	Low active pulse signal indicating an error in the printer
$\overline{\text{SELECTIN}}$	Input	Signal for the IEEE1284 standard

7.4 UNIVERSAL SERIAL BUS (USB) INTERFACE

This printer supports the USB 2.0-compliant interface and the transfer rate at 12.5 Mbits/second.

7.4.1 Basic Specifications of USB interface

The USB interface is available with all three types of boards.

Interface connector	 <p>Series B plug Cable length: 5m or less (Twisted Pair Shielded)</p>														
Version	USB 2.0														
Maximum receive buffer capacity	<p>1MB</p> <p style="text-align: center;">0MB 1MB</p> <p>Buffer near full occurred  Remaining 0.25MB</p> <p>Buffer near full released  Remaining 0.5MB</p>														
Interface type	<p>Use Printer configuration tool or <DI> command. <DI>a</p> <table border="1" data-bbox="545 1186 1377 1453"> <thead> <tr> <th>Parameter</th> <th>Item</th> <th>Value</th> <th>Description</th> </tr> </thead> <tbody> <tr> <td rowspan="4">a</td> <td rowspan="4">Interface</td> <td>0</td> <td>USB</td> </tr> <tr> <td>1</td> <td>RS-232C/LAN/IEEE1284</td> </tr> <tr> <td>2</td> <td>Keypad</td> </tr> <tr> <td>3</td> <td>Scanner/ Smart keyboard</td> </tr> </tbody> </table>	Parameter	Item	Value	Description	a	Interface	0	USB	1	RS-232C/LAN/IEEE1284	2	Keypad	3	Scanner/ Smart keyboard
Parameter	Item	Value	Description												
a	Interface	0	USB												
		1	RS-232C/LAN/IEEE1284												
		2	Keypad												
		3	Scanner/ Smart keyboard												

7.4.2 Pin Assignments

Pin No.	Description
1	VBus
2	-Data(D-)
3	+Data(D+)
4	GND

7.4 UNIVERSAL SERIAL BUS (USB) INTERFACE (cont'd)

7.4.3 Host Computer Settings

Installation of USB Standard Print Support

It is necessary to install the USB driver in addition to the printer driver to perform print operation via the USB port.

As for the USB driver installation procedure, refer to [How to Install the USB Standard Print Support] in the printer driver installation specifications.

Notes

- OS environment corresponding to the USB interface is [Windows2000/XP/Server2003/Vista], however, the connection may not be established depending on the manufacturers or models. For more details, refer to your host computer documentation.
- USB cable length under 1m is recommended.
- Device name of USB port should be "Serial number".
For example: CRGY0032

7.5 LOCAL AREA NETWORK (LAN) ETHERNET

7.5.1 Basic Specifications of LAN

A Local Area Network (LAN) interface requires a driver shipped with each printer that has the interface installed. The driver must be loaded on the host computer and configured to run one of the supported network protocols using a 10/100BaseT LAN connection.

Interface connector	 <p>Cable type: For 10BASE-T and 100BASE-TX Cable length: 100m or less</p>												
Link/Status LED	<p>Status LED lights up when establishing the LINK with Ethernet equipment. The LINK is established by Auto Negotiation.</p> <table border="1" data-bbox="537 873 1386 1171"> <thead> <tr> <th>LED</th> <th>Color</th> <th>Conditions</th> </tr> </thead> <tbody> <tr> <td>LINK</td> <td>Green</td> <td>Lights up when establishing the LINK</td> </tr> <tr> <td>SPEED</td> <td>Orange</td> <td>Lights off when recognizing the destination 10BASE-T Lights up when recognizing the destination 100BASE-TX</td> </tr> <tr> <td>COLLISION</td> <td>Red</td> <td>Lights up when collision occurs</td> </tr> </tbody> </table>	LED	Color	Conditions	LINK	Green	Lights up when establishing the LINK	SPEED	Orange	Lights off when recognizing the destination 10BASE-T Lights up when recognizing the destination 100BASE-TX	COLLISION	Red	Lights up when collision occurs
LED	Color	Conditions											
LINK	Green	Lights up when establishing the LINK											
SPEED	Orange	Lights off when recognizing the destination 10BASE-T Lights up when recognizing the destination 100BASE-TX											
COLLISION	Red	Lights up when collision occurs											
Maintenance function	<p>[Printing LAN configuration information] LAN configuration information will be printed on the third sheet of user test print and factory test print.</p> <p>[Initializing LAN configuration information] LAN configuration information will be initialized through [All Clear] of Factory Clear Mode. For more details, refer to the authorised SATO servicing personnel.</p>												
Interface type	<p>Use Printer configuration tool or <DI> command. <DI>a</p> <table border="1" data-bbox="537 1520 1386 1682"> <thead> <tr> <th>Parameter</th> <th>Item</th> <th>Value</th> <th>Decription</th> </tr> </thead> <tbody> <tr> <td rowspan="2">a</td> <td rowspan="2">Interface</td> <td>0</td> <td>USB</td> </tr> <tr> <td>1</td> <td>LAN</td> </tr> </tbody> </table>	Parameter	Item	Value	Decription	a	Interface	0	USB	1	LAN		
Parameter	Item	Value	Decription										
a	Interface	0	USB										
		1	LAN										

7.5 LOCAL AREA NETWORK (LAN) ETHERNET (cont'd)

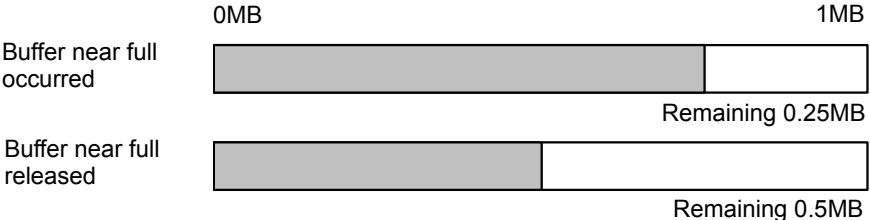
<p>Communication configuration</p>	<p>The following settings can be configured via the Printer configuration tool or commands.</p> <table border="1" data-bbox="537 348 1386 905"> <thead> <tr> <th>Item</th> <th>Command</th> <th>Setting range</th> </tr> </thead> <tbody> <tr> <td>LAN mode</td> <td><I3></td> <td>Protocol for driver (STATUS4) cyclic response mode *1 Protocol for driver (STATUS4) ENQ response mode *1 STATUS3 *2</td> </tr> <tr> <td>IP address</td> <td><W1></td> <td>0.0.0.0 ~ 255.255.255.255</td> </tr> <tr> <td>Subnet mask</td> <td><W2></td> <td>0.0.0.0 ~ 255.255.255.255</td> </tr> <tr> <td>Gateway address</td> <td><W3></td> <td>0.0.0.0 ~ 255.255.255.255</td> </tr> <tr> <td>IP address setup</td> <td><WI></td> <td>Manual DHCP</td> </tr> <tr> <td>RARP</td> <td><WM></td> <td>RARP disabled RARP enabled</td> </tr> </tbody> </table> <p>*1 2-port connection by Port1024 and Port1025 or 1 port connection by Port9100. *2 1 port connection by Port1024 or Port9100.</p>	Item	Command	Setting range	LAN mode	<I3>	Protocol for driver (STATUS4) cyclic response mode *1 Protocol for driver (STATUS4) ENQ response mode *1 STATUS3 *2	IP address	<W1>	0.0.0.0 ~ 255.255.255.255	Subnet mask	<W2>	0.0.0.0 ~ 255.255.255.255	Gateway address	<W3>	0.0.0.0 ~ 255.255.255.255	IP address setup	<WI>	Manual DHCP	RARP	<WM>	RARP disabled RARP enabled
Item	Command	Setting range																				
LAN mode	<I3>	Protocol for driver (STATUS4) cyclic response mode *1 Protocol for driver (STATUS4) ENQ response mode *1 STATUS3 *2																				
IP address	<W1>	0.0.0.0 ~ 255.255.255.255																				
Subnet mask	<W2>	0.0.0.0 ~ 255.255.255.255																				
Gateway address	<W3>	0.0.0.0 ~ 255.255.255.255																				
IP address setup	<WI>	Manual DHCP																				
RARP	<WM>	RARP disabled RARP enabled																				
<p>Maximum receive buffer capacity</p>	<p>1MB</p>  <p>0MB 1MB</p> <p>Buffer near full occurred Remaining 0.25MB</p> <p>Buffer near full released Remaining 0.5MB</p>																					

7.5.2 Software Specifications

Protocol TCP/IP
 Network layer ARP, RARP, IP, ICMP
 Session layer TCP, UDP
 Application layer LPR, FTP, TELNET, BOOTP, DHCP, HTTP

Notes

- Send the print data by LPR and FTP of TCP/IP and dedicated socket protocol. (STATUS3, Protocol for driver (STATUS4))
- Use socket connection to get the printer status.

7.5 LOCAL AREA NETWORK (LAN) ETHERNET (cont'd)

7.5.3 TCP/IP Specifications

In TCP/IP protocol environment, LPD and FTP are provided for printing. TELNET is provided for the setup of various variables, and ARP, RARP and BOOTP/DHCP for the setup of IP address are available.

In socket connection, the printing operation and the status are monitored. In this case, multiple connections cannot be established at the same time.

WindowsNT and Windows2000/XP/Server2003/Vista operating system support LPD of TCP/IP that enables you to print; however, Windows98/Me is not configured with LPD. In order to perform printing operation, off-the-shelf printing software is required.

7.5.4 LPD Specifications

LPD protocol complies with RFC1179 and handles the list of logical printer name as queue name such as lp, sjis and euc.

Queue name	Kanji filter applied	Input Kanji code
lp	Not available	N/A
sjis	Available	Shift JIS
euc	Available	EUC

When sending a job by LPR, the transmission order of data file/control file within the job does not affect the printing operation.

Notes

- A job deletion by LPR is not supported.
- LPD is available only for Protocol for Driver (STATUS4).
- If executing a large quantity of printing by LPD, some parts of the data may be missing due to the Windows specification.

7.5.5 FTP Specifications

FTP protocol complies with RFC959 and handles the list of logical printer name as transfer directory. File transfer to this directory executes printing operation. Note that it is possible to specify ASCII(A), BINARY(I), and TENEX(L8) as transfer modes although mode difference is dependent on the client side.

There are three directory names such as lp, sjis and euc.

Queue name	Kanji filter applied	Input Kanji code
lp	Not available	N/A
sjis	Available	Shift JIS
euc	Available	EUC

7.5 LOCAL AREA NETWORK (LAN) ETHERNET (cont'd)

7.5.6 TELNET Specifications

TELNET complies with RFC854. This consists of an interactive menu form, and it enables you to change and refer internal setup and to display status. To change the setting details, enter 'root' user name and password at the time of login. Default ROOT password is set to null (line feed only).

<TELNET command example>

In MS-DOS command prompt, type in [TELNET xxx.xxx.xxx.xxx (IP address)] and enter user name and password to advance to the display below.

SATO PRINTER ModelName TELNET server.
Copyright 2006(C) SATO Corporation.

login: root
'root' user needs password to login
password:
User 'root' logged in

No.	Item	Value	(level.1)
1	Setup TCP/IP		
2	Display status		
99	Exit setup		
Please select(1-99)?			

Each printer model name will appear in [Model Name].

For the detailed settings of [1:Setup TCP/IP], refer to **Section 7.5.7 Setting/Displayed Items**.

7.5.7 Setting/Displayed Items

The following table shows the settings and referable sections as well as various variables.

TCP/IP related settings

Variable identifier	Default (Factory setting)	Setting range
IP address	0.0.0.0 (Externally obtained)	0.0.0.0 ~ 255.255.255.255
Subnet mask	0.0.0.0 (Derived from IP address)	0.0.0.0 ~ 255.255.255.255
Gateway address	0.0.0.0 (Invalid)	0.0.0.0 ~ 255.255.255.255
RARP protocol	ENABLE	ENABLE/DISABLE
DHCP protocol	ENABLE	ENABLE/DISABLE
Keep alive time	180(sec)	30 ~ 300
Socket cancel	Normal	Normal / compatible
ROOT password	NULL (No password)	Up to 16 random alphanumeric characters

7.5 LOCAL AREA NETWORK (LAN) ETHERNET (cont'd)

Notes

- 1) For the detailed On-board LAN interface settings, refer to the included [Setup Guide] and the Network Utility of [SATO Accessory CD-ROM].
- 2) To open/close Print data port (Port1024), Status port (Port1025) or Sending/Receiving port (Port9100), make sure to close and open the port at intervals of approximately 150ms to 200ms. If you don't have enough time from closing to opening the port, it may result in double connection.
If the host requests the connection to the port already connected (Port1024, Port1025 or Port9100), the printer accepts the request (establishing double connection); however, the printer disconnects the second connection immediately.
- 3) Do not connect and disconnect the LAN cable while starting up the printer. Restart the printer with which you are having a communication error due to connection/disconnection of the LAN cable.

This page is intentionally left blank

8

APPENDIX

The following information is provided:

- 8.1 Optional Accessories - Cutter
- 8.2 Optional Accessories - Dispenser
- 8.3 Positions of sensors and options
- 8.4 Operation Mode Selection
- 8.5 Base Reference Point
- 8.6 Offset position Adjustment
- 8.7 Paper End
- 8.8 Ribbon End

8.1 OPTIONAL ACCESSORIES - CUTTER

The cutter should only be installed by SATO qualified servicing personnel.

8.1.1 To route the media when the cutter is installed

Loading of the media for cutter unit is similar to the usual procedure as explained in **Section 2.3 Loading Labels**.

8.1.2 Cut position Adjustment

If the cutting position is not at the regular position as mentioned below, you can change the **offset setting** with the SBPL commands.

Notes when using media with optional cutter

- **Cutting of Labels**

The correct cutting position is at the label gap. Cutting onto the label must be avoided because the label adhesive that accumulates on the blade will affect cutter sharpness.

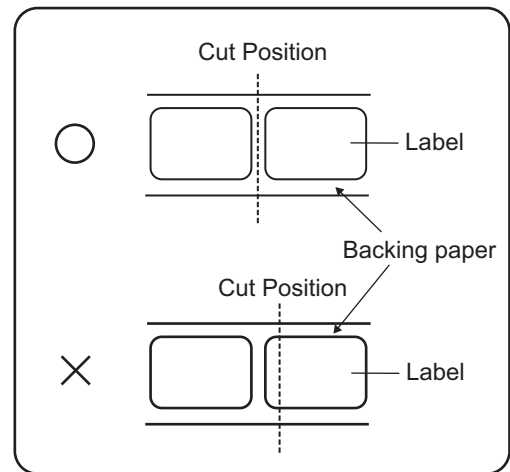

- **Cutting Media with Perforation**

As for media with perforation, **cutting on or in front of the perforated lines is prohibited**. Cutting in those locations could cause the media to jam and the printer to malfunction.

The perforated line +1 mm (+0.04") is the cut prohibited zone (see Figure 1).

The folded perforated line +4 to +25 mm (+0.15" to +0.98") of fan-folded paper is the cut prohibited zone (see Figure 2).

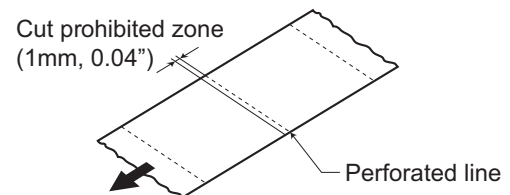

Figure 1

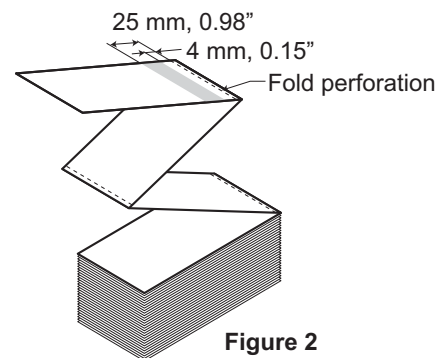

Figure 2

8.1 OPTIONAL ACCESSORIES - CUTTER (cont'd)

8.1.3 Cutter replacement

Over time, the cutter loses its cutting ability and begins to show signs of wear.

Replace the cutter unit when the blade becomes blunt and cut edges are rough. (Please contact an authorised SATO Representative for replacement.)

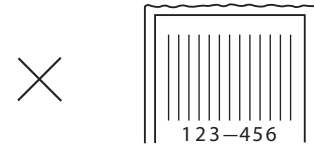
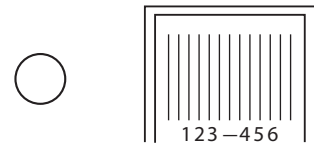

8.2 OPTIONAL ACCESSORIES - DISPENSER

Dispenser should only be installed by SATO qualified servicing personnel.

8.2.1 To route the label when the dispenser is installed

1. With the power supply off, pull the **cover open/close latches** on both sides of the printer toward you to unlock the top cover, and then open the **top cover**. Make sure that the cover rests firmly so that it will not fall forward and injure your hands.
2. With your thumbs positioned on the two corners of the **pressure bracket**, push the **pressure bracket** up and pull it forward to open the **pressure bracket**.

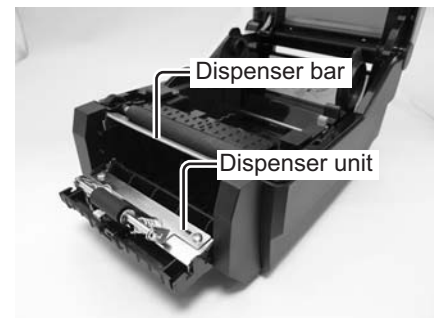
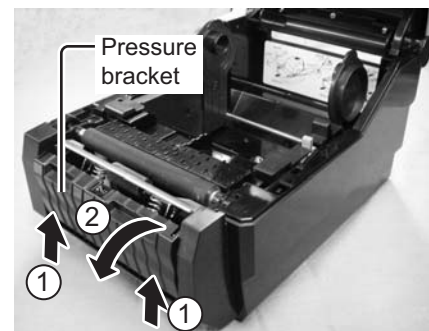

3. Peel off the first two leading labels from the liner (backing paper) and then load the label roll on the **media holder**. After pulling out the leading liner (backing paper), pass the liner (backing paper) through the **media guides** and then pass over the **dispenser bar** so as to cover it. Then pass the liner (backing paper) under the **pressure bracket** as shown.

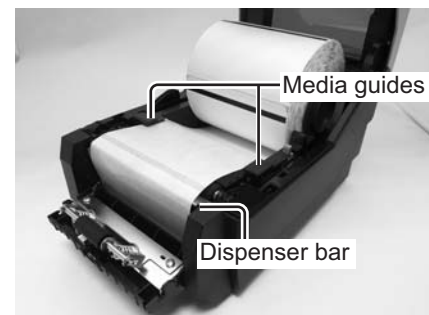

8.2 OPTIONAL ACCESSORIES - DISPENSER (cont'd)

4. If the paper is not taut, roll the paper on the **media holder** so that the paper is taut.
Next, tightly close the **pressure bracket** with the liner (backing paper) passing through it.

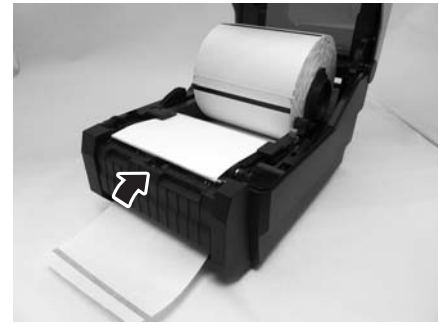

5. Close the **top cover** until it clicks into position.
6. After turning on the label, turn on the power.
The printer is online and the **ON LINE (POWER)** indicator lights green.

When the printer is ready, press the **FEED/LINE** button to output an empty label and stop at the dispenser. This procedure is to ensure that the label is loaded correctly.

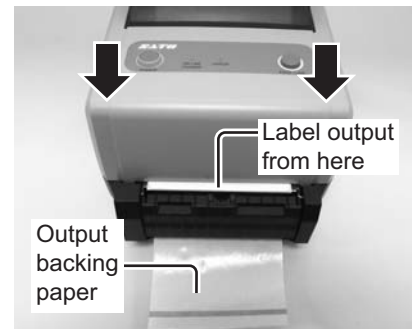

8.2.2 Stop position Adjustment

Normally, the label is dispensed to the point where 2 or 3mm (0.08" or 0.1") of the label remain on the liner (backing paper).

If the label is not dispensed at the regular position, you can change the **offset setting** with the SBPL commands. After adjusting the stop position, dispense two or three labels to fix the stop position.

Notes:

- There may be cases when the dispenser does not function properly due to the thickness of the labels used.
- The Dispenser unit is effective for label pitch 22 to 100 mm (0.86" to 3.93"). However, the label size limitation may vary with application conditions.
- Labels over 100mm (3.9") may curl at dispenser due to the nature of the material. There is no remedy for this.

8.3 POSITIONS OF SENSORS AND OPTIONS

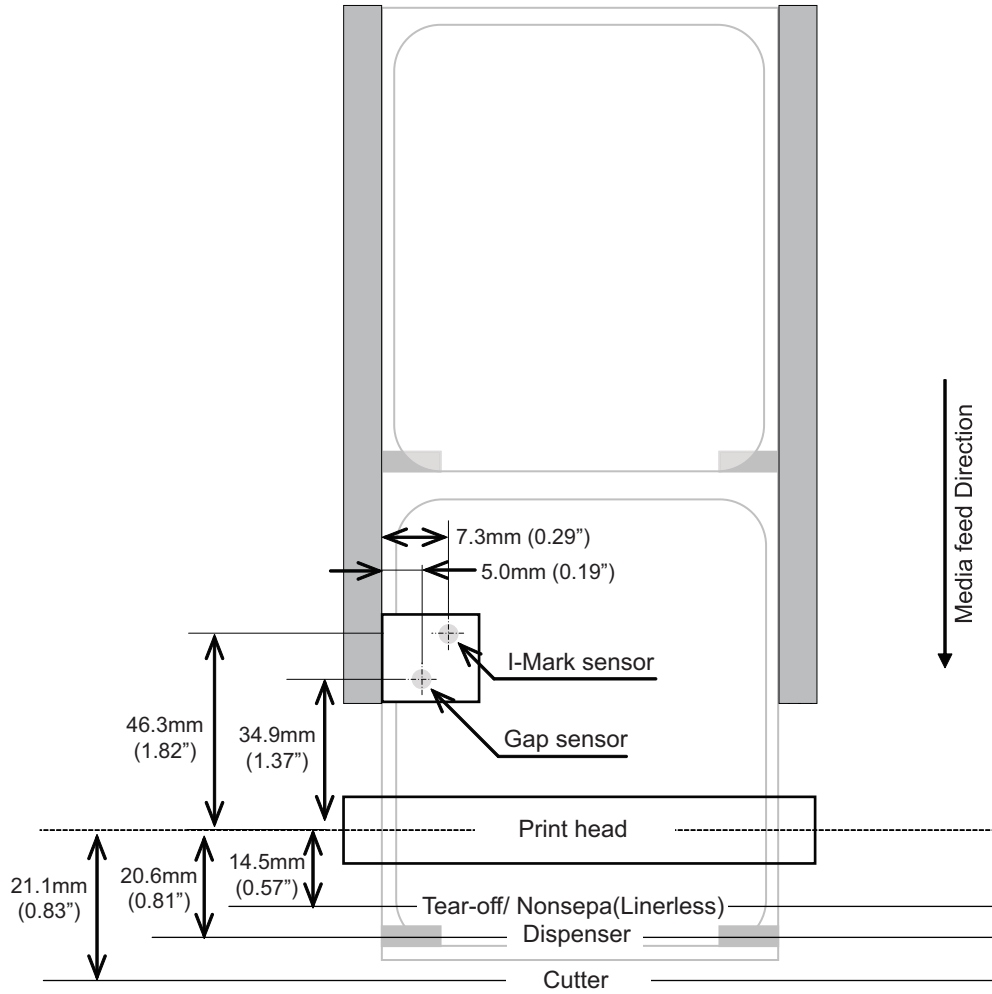

8.4 OPERATION MODE SELECTION

There are five modes of printer operation: Continuous, Tear-off, Cutter, Dispense and Linerless (nonsepa) mode. The differences are the ways in which the label and paper backing are ejected. Before printer configuration, one must determine which mode will be used. This section identifies the functional differences among the five.

CONTINUOUS MODE

With this mode of operation, the media remains in position for printing at all times. To do so, means that the previous printed label is only available for removal when one to four additional labels have been printed (quantity depends on label size). This mode of operation is specifically suited for printing bulk quantities to be applied later on.

TEAR-OFF MODE

With this mode of operation, after printing, the printer feeds the first (outermost) label so that it is fully extended out of the printer's front for removal. Printing of the next label will not begin until the prior printed label has been removed. This mode of operation is specifically suited for immediate application at the time of print.

Upon removal of the prior printed label, the printer retracts the media so that the next label in line may be printed, then the printer feeds it. This cycle repeats for each consecutive label.

CUTTER MODE

With the optional cutter unit installed and enabled, this mode of operation will cut individual printed labels or in multiples. The media will be advanced to the cutter blade, the label cut will occur, and the unprinted media will retract for positioning of the next print.

DISPENSE MODE

When the optional dispenser is installed and enabled, this mode of operation will peel the liner (paper backing) from the printed label as it is advanced to the printer's front. Once the printed label has been removed from the printer for application, the unprinted media will retract and position itself so the next label may be printed.

This operational mode is specifically applicable to print operations where the label is to be immediately adhered.

LINERLESS (Non Sepa) MODE

When the linerless option is installed and enabled, this mode of operation allows for the feeding and printing of linerless media. In this mode, the printer's functionality is the same as with the continuous or tear-off modes depending on configuration settings.

8.5 BASE REFERENCE POINT

The base reference point is the point at which one determines the print and cut positions.
The base reference position differs, depending on the print mode or the label pitch sensor to be used.

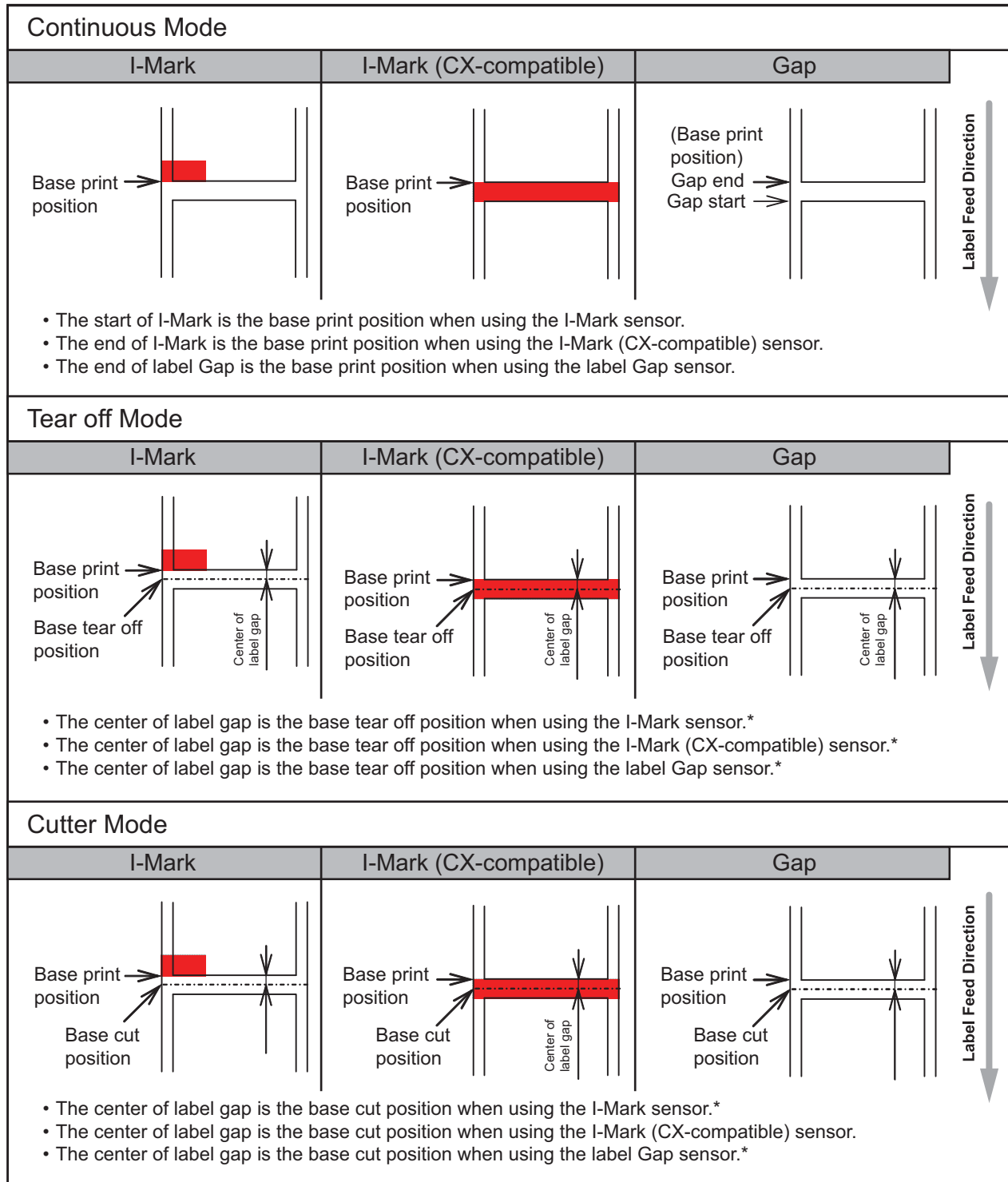

* Default value of label gap saved in the printer is 3mm (0.12"). Therefore, the distance from the base print position to the center of label gap is 1.5mm (0.06") (Default value). When the size of label gap is not 3mm (0.12"), use the <PC> command or the <PG> command to set the gap size properly. For the command details, refer to the Command Reference.

8.5 BASE REFERENCE POINT (cont'd)

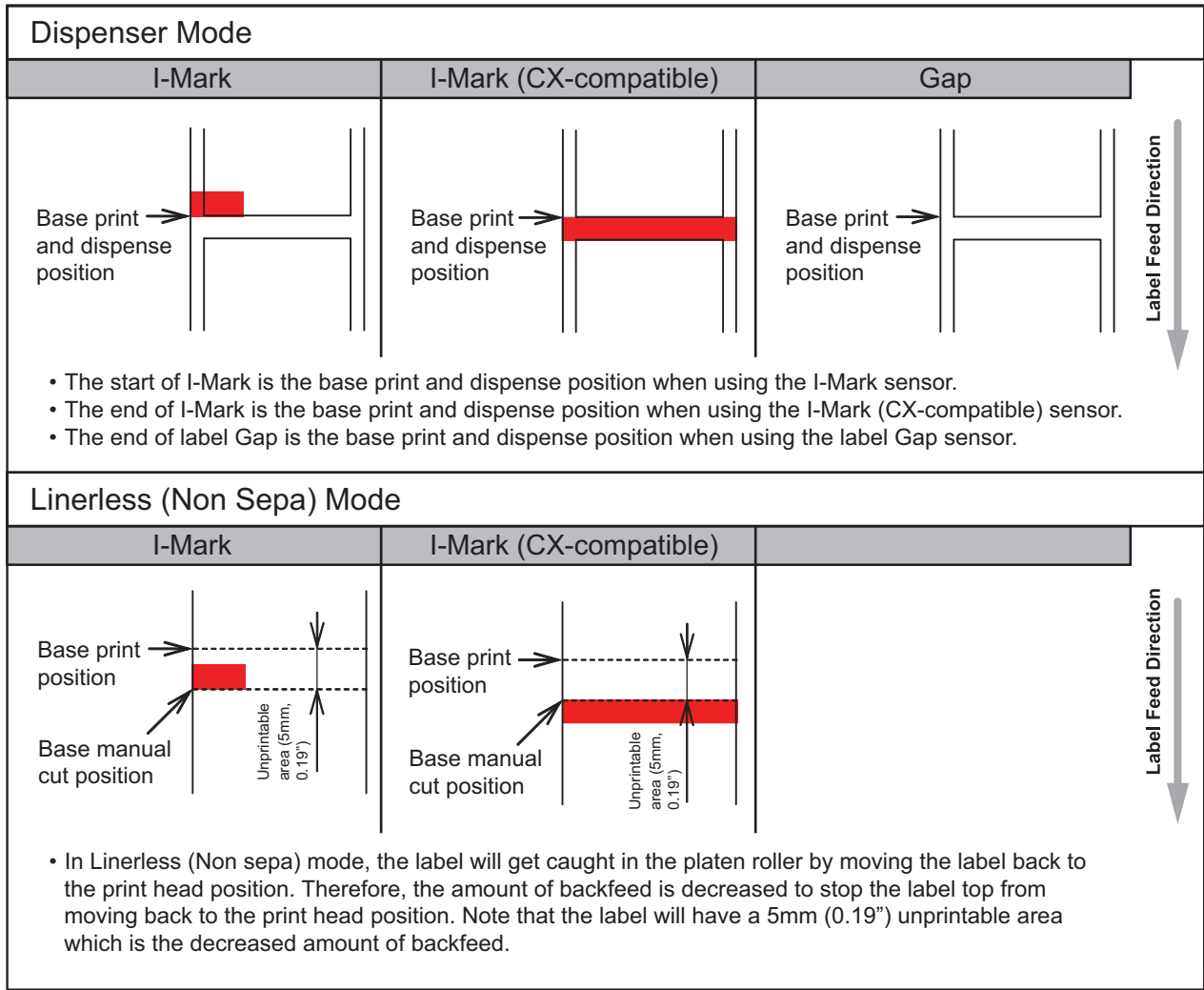

8.5.1 Base Reference point Adjustment

Print Position Offset refers to the vertical and horizontal shifting of the entire print area, relative to the start position of printing (V=0, H=0), defined by default to be the bottom right hand corner of the label.

The Base Reference point can be adjusted by using the Printer Utilities Tool application or by sending the <A3> command from the host.

The V setting is for the Vertical print offset. A positive (+) offset means the printing is shifted towards the print head; a negative (-) offset means shifting away from the print head.

The H setting is for the Horizontal print offset. The + or - prefix determines whether the offset is to the left or to the right of the reference point.

The default value of both positions is +000 dot. The maximum values that can be set for each is +/-792 dot.

You may wish to make a test print after completing the adjustments to ensure they are correct. Refer to **Section 3.3 User Test Print Mode** for details.

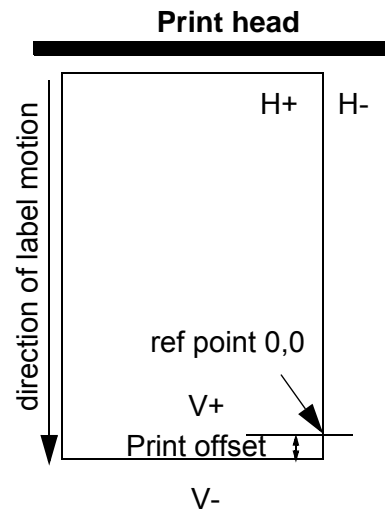

8.6 OFFSET POSITION ADJUSTMENT

This setting adjusts the option (Cutter, Dispenser, Tear off) stop position after a print out. The Offset position can be adjusted by using SATO Utilities Tool application or by sending command <PO> from the host. The setting range is within ± 99 dots. A positive value moves the leading edge of the label forward (away from the print head) while a negative value moves the leading edge of the label back toward the mechanism.

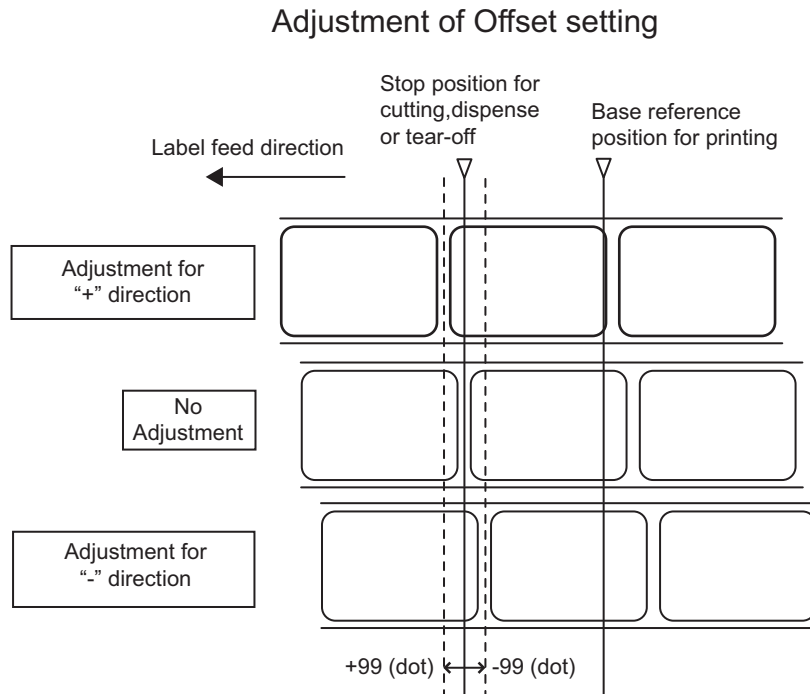

8.7 PAPER END

8.7.1 Roll Label End

When the Label End is less than 40mm (1.57") from the end of I-Mark

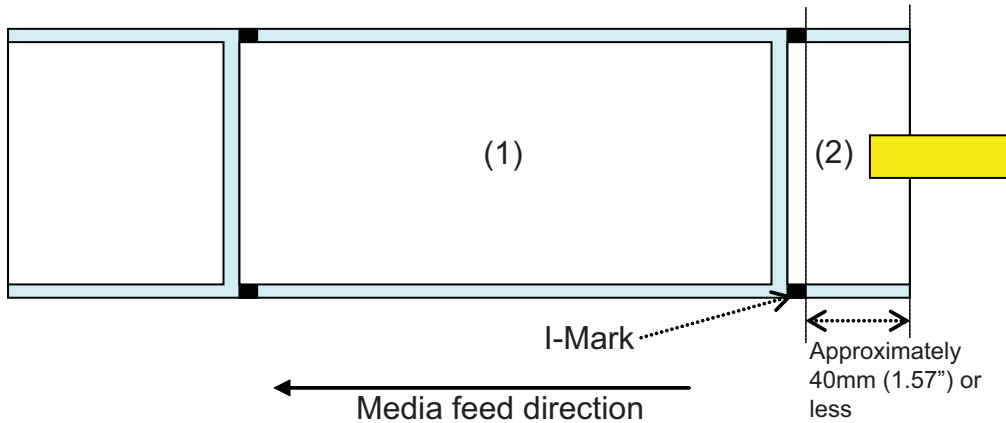

The printer behavior when paper end is detected is as follows:

- After completing the print of label (1), "Paper end error" will occur.
- In cutter mode, "Paper end error" will occur after cutting the label.
- After releasing the error, Label (1) will not be printed again.

Note:

The paper end detection is performed by the I-Mark sensor, therefore, the above motion may not occur depending on the adjustment of the I-Mark sensor.

When the Label End is More Than 40mm (1.57") from the end of I-Mark

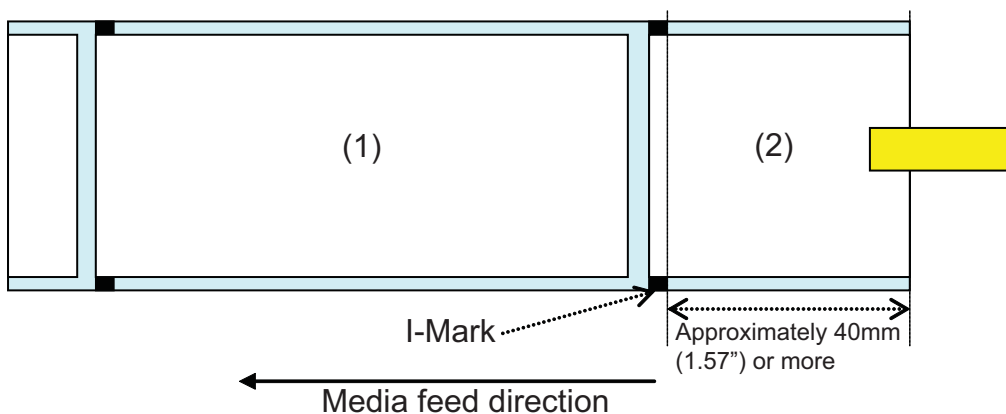

The printer behavior when paper end is detected is as follows:

- "Paper end error" will occur while printing the label (2).
- If an error occurs while printing, label (2) will be printed again after releasing the error. If the print job is completed at the time of error occurrence, label (2) will not be printed again.
- In cutter mode, cutting motion will not occur when the printer has a "Paper end error."

Note:

The paper end detection is performed by the I-Mark sensor, therefore, the above motion may not occur depending on the adjustment of the I-Mark sensor.

8.7.2 Fanfold Label End

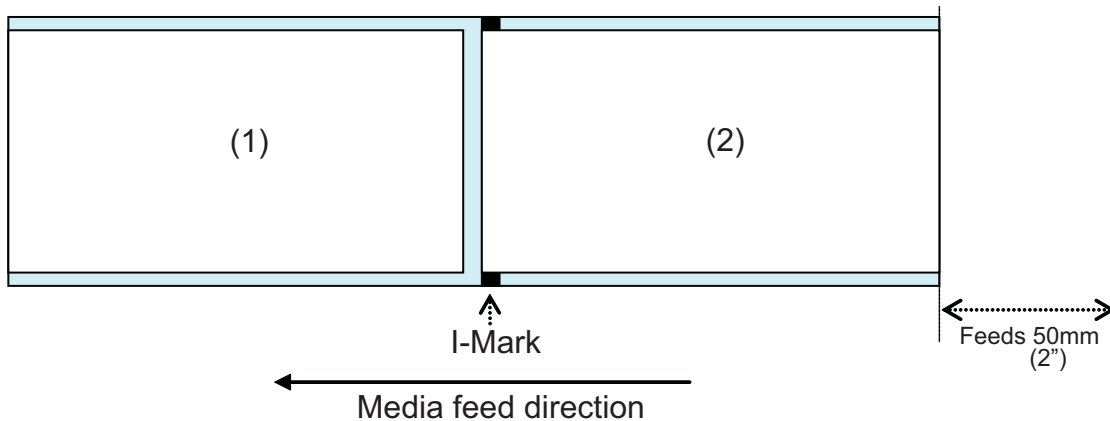

The printer behavior when paper end is detected is as follows:

- After printing and feeding label (2) 50mm (2"), "Paper end error" will occur.
- If an error occurs while printing, label (2) will be printed again after releasing the error. If the print job is completed at the time of error occurrence, label (2) will not be printed again. (Also, when the print job is completed while feeding the label 50mm (2"), the label will not be reprinted.)
- In cutter mode, cutting motion will not occur when the printer has a "Paper end error."

Note:

The paper end detection is performed by the I-Mark sensor, therefore, the above motion may not occur depending on the adjustment of the I-Mark sensor.

8.8 RIBBON END

Ribbon End detection is only available for CG408TT and CG412TT printers.

Printer behavior when ribbon near end is detected is as follows:

- Ribbon near end can be detected by setting printing method to thermal transfer.
- When the ribbon remaining becomes 5 to 7m (16.4 ft. to 22.9 ft.), "Ribbon near end" will be detected. The status of ribbon near end will be returned if status request (ENQ) is made.

Printer behavior when ribbon end is detected:

- Ribbon end can be detected by setting printing method to thermal transfer.
- If the print job is completed at the time of "Ribbon end error", the label will not be printed again after releasing the error.
- If "Ribbon end error" occurs while printing, the label will be printed again after releasing the error.

This page is intentionally left blank

9

SATO GROUP OF COMPANIES

SATO GROUP OF COMPANIES

Asia Pacific & Oceania Region

SATO ASIA PACIFIC PTE. LTD.
438A Alexandra Road #05-01/04,
Alexandra Technopark, Singapore 119967
Tel: +65-6271-5300
Fax: +65-6273-6011
Email: technical@satoasiapacific.com
www.satoasiapacific.com

SATO AUTO-ID MALAYSIA SDN. BHD.
No.25, Jalan Pemberita U1/49,
Temasya Industrial Park, Section U1,
40150 Shah Alam, Selangor Darul Ehsan,
Malaysia
Tel: +60-3-7620-8901
Fax: +60-3-5569-4977
Email: service@satosms.com.my
www.satoasiapacific.com

SATO AUTO-ID (THAILAND) CO., LTD.
292/1 Moo 1 Theparak Road,
Tumbol Theparak, Amphur Muang,
Samutprakarn 10270, Thailand
Tel: +66-2-736-4460
Fax: +66-2-736-4461
Email: technical@satothailand.com
www.satothailand.co.th

SATO SHANGHAI CO., LTD.
307 Haining Road, ACE Bldg,
10th Floor, Hongkou Area,
Shanghai 200080, China
Tel: +86-21-6306-8899
Fax: +86-21-6309-1318
Email: tech@satochina.com
www.satochina.com

SATO ASIA PACIFIC PTE. LTD.
Korea Representative Office
6F, Korea Housing Center,
Yeouido-dong 45-11, Yeongdeungpo-gu,
Seoul 150-736, Korea
Tel: +82-2-761-5072
Fax: +82-2-761-5073
Email: technical@satoasiapacific.com
www.satokorea.com

SATO ASIA PACIFIC PTE. LTD.
India Representative Office
Regus Level 2, Connaught Place,
Bund Garden Road, Pune. 411001, India
Tel: +91-20-4014-7747
Fax: +91-20-4014-7576
Email: technical@satoasiapacific.com
www.satoasiapacific.com

SATO AUSTRALIA PTY LTD.
1/1 Nursery Avenue, Clayton Business
Park, Clayton, VIC 3168, Australia
Tel: +61-3-8814-5330
Fax: +61-3-8814-5335
Email: enquiries@satoaustralia.com
www.satoaustralia.com

SATO NEW ZEALAND LTD.
30 Apollo Drive, Mairangi Bay
Auckland, New Zealand
Tel: +64 9-477-2222
Fax: +64-9-477-2228
Email:
global.warranty@satonewzealand.com
www.satonewzealand.com

European Region

**SATO LABELLING SOLUTIONS
EUROPE GmbH (GERMANY)**
Ersheimer Straße 71,
69434 Hirschhorn, Germany
Tel: +49-6272-9201-324
Fax: +49-6272-9201-399
Email: service@de.satoeurope.com
www.satoeurope.com

**SATO LABELLING SOLUTIONS
EUROPE GmbH (NETHERLANDS)**
Techniekweg 1b, 3481 MK Harmelen,
Netherlands
Tel.: +31-348-444437
Fax: +31-348-446403
Email: info@nl.satoeurope.com
www.satoeurope.com

**SATO LABELLING SOLUTIONS
EUROPE GmbH (ITALY)**
Viale Europa 39/1,
20090 Cusago, Milano, Italy
Tel.: +39-02-903-944-64
Fax: +39-02-903-940-35
Email: info@it.satoeurope.com
www.satoeurope.com

SATO POLSKA SP. Z O.O.
ul. Wroclawska 123, Radwanice,
55-015 Św. Katarzyna, Poland
Tel: +48-71-381-03-60
Fax: +48-71-381-03-68
Email: info@sato.pl
www.sato.pl

SATO IBERIA S.A.U.
Dels Coralls Nous, 35-39
Pol. Can Roqueta, 08202 - Sabadell
Barcelona, Spain
Tel: +34-902-333-341
Fax: +34-902-333-349
Email: info@es.satoeurope.com
www.satoeurope.com

SATO FRANCE S.A.S.
Parc d'Activités, Rue Jacques Messenger,
59 175 Templemars, France
Tel: +33-3-20-62-96-40
Fax: +33-3-20-62-96-55
www.satoeurope.com

SATO UK LTD.
Valley Road, Harwich,
Essex CO12 4RR, United Kingdom
Tel: +44-1255-240000
Fax: +44-1255-240111
Email: enquiries@satouk.com
www.satouk.com

American Region

SATO AMERICA, INC.
10350-A Nations Ford Road, Charlotte,
NC 28273, U.S.A.
Tel: +1-704-644-1650
Fax: +1-704-644-1662
www.satoamerica.com

**SATO LABELING SOLUTIONS
AMERICA, INC.**
1140 Windham Parkway, Romeoville,
Illinois 60446, U.S.A.
Tel: +1-630-771-4200
Fax: +1-630-771-4210
www.satolabeling.com

- Extensive contact information of worldwide SATO operations can be found on the Internet at www.satoworldwide.com