

USER MANUAL

ProLite

LCD Monitor

ENGLISH

ProLite TF4637MSC
ProLite TF5537MSC

Thank you very much for choosing the iiyama LCD monitor.

We recommend that you take a few minutes to read this comprehensive manual carefully before installing and switching on the monitor. Please keep this manual in a safe place for your future reference.

CE MARKING DECLARATION OF CONFORMITY

This LCD monitor complies with the requirements of the EC/EU Directive 2014/30/EU "EMC Directive", 2014/35/EU "Low Voltage Directive" and 2011/65/EU "RoHS Directive".

Warning

This is a class A product. In a domestic environment this product may cause radio interference in which case the user may be required to take adequate measures.

IYAMA CORPORATION: Wijkemeerstraat 8, 2131 HA Hoofddorp, The Netherlands

Model No. : PL4637 / PL5537



We recommend recycling of used product. Please contact your dealer or iiyama service center. Recycle information is obtained via the Internet, using the address: <http://www.iiyama.com>

You can access the Web page of different countries from there.

- We reserve the right to change specifications without notice.
- All trademarks used in this user manual are the property of their respective owners.

TABLE OF CONTENTS

| | |
|---|----|
| FOR YOUR SAFETY..... | 1 |
| SAFETY PRECAUTIONS..... | 1 |
| SPECIAL NOTES ON LCD MONITORS..... | 3 |
| CUSTOMER SERVICE..... | 4 |
| CLEANING..... | 4 |
| BEFORE YOU OPERATE THE MONITOR..... | 5 |
| FEATURES..... | 5 |
| CHECKING THE CONTENTS OF THE PACKAGE..... | 5 |
| UNPACKING..... | 6 |
| SPECIAL NOTES ON..... | 6 |
| CONTROLS AND CONNECTORS : MONITOR..... | 7 |
| INSTALLATION..... | 8 |
| CONTROLS AND CONNECTORS : | |
| REMOTE CONTROL (For maintenance)..... | 10 |
| PREPARING THE REMOTE CONTROL..... | 11 |
| BASIC OPERATION..... | 12 |
| CONNECTING YOUR MONITOR..... | 15 |
| COMPUTER SETTING..... | 16 |
| OPERATING THE MONITOR..... | 17 |
| ADJUSTMENT MENU CONTENTS..... | 19 |
| SCREEN ADJUSTMENTS..... | 24 |
| POWER MANAGEMENT FEATURE..... | 27 |
| TROUBLE SHOOTING..... | 28 |
| RECYCLING INFORMATION..... | 29 |
| APPENDIX..... | 30 |
| SPECIFICATIONS : ProLite TF4637MSC..... | 30 |
| SPECIFICATIONS : ProLite TF5537MSC..... | 31 |
| DIMENSIONS : ProLite TF4637MSC..... | 32 |
| DIMENSIONS : ProLite TF5537MSC..... | 32 |
| COMPLIANT TIMING..... | 33 |

FOR YOUR SAFETY

SAFETY PRECAUTIONS

WARNING

STOP OPERATING THE MONITOR WHEN YOU SENSE TROUBLE

If you notice any abnormal phenomena such as smoke, strange sounds or fumes, unplug the monitor and contact your dealer or iiyama service center immediately. Further use may be dangerous and can cause fire or electric shock.

NEVER REMOVE THE CABINET

High voltage circuits are inside the monitor. Removing the cabinet may expose you to the danger of fire or electric shock.

DO NOT PUT ANY OBJECT INTO THE MONITOR

Do not put any solid objects or liquids such as water into the monitor. In case of an accident, unplug your monitor immediately and contact your dealer or iiyama service center. Using the monitor with any object inside may cause fire, electric shock or damage.

INSTALL THE MONITOR ON A FLAT, STABLE SURFACE

The monitor may cause an injury if it falls or is dropped.

DO NOT USE THE MONITOR NEAR WATER

Do not use where water may be splashed or spilt onto the monitor as it may cause fire or electric shock.

OPERATE UNDER THE SPECIFIED POWER SUPPLY

Be sure to operate the monitor only with the specified power supply. Use of an incorrect voltage will cause malfunction and may cause fire or electric shock.

PROTECT THE CABLES

Do not pull or bend the power cable and signal cable. Do not place the monitor or any other heavy objects on the cables. If damaged, the cables may cause fire or electric shock.

ADVERSE WEATHER CONDITIONS

It is advisable not to operate the monitor during a heavy thunder storm as the continual breaks in power may cause malfunction. It is also advised not to touch the plug in these circumstances as it may cause electric shock.

CAUTION

INSTALLATION LOCATION

Do not install the monitor where sudden temperature changes may occur, or in humid, dusty or smoky areas as it may cause fire, electric shock or damage. You should also avoid areas where the sun shines directly on the monitor.

DO NOT PLACE THE MONITOR IN A HAZARDOUS POSITION

The monitor may topple and cause injury if not suitably located. Please also ensure that you do not place any heavy objects on the monitor, and that all cables are routed such that children may not pull the cables and possibly cause injury.

MAINTAIN GOOD VENTILATION

Ventilation slots are provided to keep the monitor from overheating. Covering the slots may cause fire. To allow adequate air circulation, place the monitor at least 10 cm (or 4 inches) from any walls.

Do not remove the tilt stand when operating the monitor. Ventilation slots on the back of the cabinet will be blocked and the monitor may overheat if the stand is removed. This may cause fire or damage. Operating the monitor on its back, side, upside down or on a carpet or any other soft material may also cause damage.

DISCONNECT THE CABLES WHEN YOU MOVE THE MONITOR

When you move the monitor, turn off the power switch, unplug the monitor and be sure the signal cable is disconnected. If you do not disconnect them, it may cause fire or electric shock.

UNPLUG THE MONITOR

If the monitor is not in use for a long period of time it is recommended that it is left unplugged to avoid accidents.

HOLD THE PLUG WHEN DISCONNECTING

To disconnect the power cable or signal cable, always pull it by the plug. Never pull on the cable itself as this may cause fire or electric shock.

DO NOT TOUCH THE PLUG WITH WET HANDS

Pulling or inserting the plug with wet hands may cause electric shock.

WHEN YOU INSTALL THE MONITOR ON YOUR COMPUTER

Be sure the computer is strong enough to hold the weight of the monitor, otherwise, you may damage your computer.

OTHERS

ERGONOMIC RECOMMENDATIONS

To eliminate eye fatigue, do not operate the monitor against a bright background or in a dark room. For optimal viewing comfort, the monitor should be just below eye level and 40-60 cm (16-24 inches) away from your eyes. When using the monitor over a prolonged time, a ten minute break every hour is recommended as looking at the screen continuously can cause eye strain.

SPECIAL NOTES ON LCD MONITORS

- The following symptoms are normal with LCD monitors and do not indicate a problem.

NOTE

- When you first turn on the LCD monitor, the picture may not fit in the display area because of the type of computer that is used. In this case, adjust the picture position to the correct position.
 - You may find slightly uneven brightness on the screen depending on the desktop pattern you use.
 - Due to the nature of the LCD screen, an afterimage of the previous screen may remain after switching the image, when the same image is displayed for hours. In this case, the screen is recovered slowly by changing the image or turning off the Power Switch for hours.
- This LCD cannot be used outdoors.
 - If you use a cable longer than the supplied one, the picture quality is not guaranteed. Touch function can be disrupted if the USB cable length exceeds 3m.

USAGE CONFIRMATION

This product is designed for optimum usage at 24hours per day.

The display is compatible for usage in Landscape/Portrait and Tabletop (face-up) applications. If being used in Tabletop application, please utilise the Fan-on function.

IMAGE PERSISTENCE / IMAGE STICKING

Please be aware that all LCD screens can experience Image Persistence or Image Sticking. This occurs when a residual image remains visible on a screen when static images are displayed for long periods of time. LCD Image Persistence is not permanent but constant images being displayed for a long period of time should be avoided.

To counteract Image Persistence, turn off the monitor for as long as the previous image was displayed, so if an image was on the monitor for 1 hour and there is evidence of a residual or “ghost” image, you should turn off the monitor for 1 hour in order to clear the residual image.

For all LFD products, iiyama recommends displaying moving images and utilising a moving screen saver at regular intervals whenever the screen is idle. You could also turn off the monitor when not in use to assist the prevention.

Other ways to reduce the risk of Image Persistence will be to utilise the FAN-on function (if available), Low Backlight and Low Brightness settings.

FOR EXTENDED USE AS A PUBLIC DISPLAY

■ Image Sticking on LCD Panel

When a static image is displayed for hours, an electric charge trace remains near the electrode inside the LCD producing a “ghost” image. (Image Persistence).

Image Persistence is not a permanent feature.

■ Recommendations

To prevent Image Sticking and promote longer life expectancy of display, we recommend the following:

1. Avoid static images displayed for long periods – change static images on continuous loop.
2. Turn off monitor when not in use, either by remote control or use Power Management or Schedule functions.
3. When monitor is installed in high ambient temperature environment(s) or in an enclosed position, utilise the Cooling Fan, Screen Saver and Low Brightness functions.
4. Suitable ventilation for any monitor is an expectation of any installation – climate control systems may need to be employed.
5. We strongly recommend utilisation of active cooling with fans for long operation times or high ambient temperature environments.

CUSTOMER SERVICE

NOTE

- If you have to return your unit for service and the original packaging has been discarded, please contact your dealer or iiyama service center for advice or replacement packaging.

CLEANING

WARNING

- If you drop any materials or liquids such as water into the monitor when cleaning, unplug the power cable immediately and contact your dealer or iiyama service center.

CAUTION

- For safety reasons, turn off the power switch and unplug the monitor before you clean it.

NOTE

- To protect the LCD panel, do not scratch or rub the screen with a hard object.
- Never use any of the following strong solvents. These will damage the cabinet and the LCD screen.

| | | |
|--------------------|---------|--------------------------|
| Thinner | Benzine | Abrasive cleaner |
| Spray-type cleaner | Wax | Acid or Alkaline solvent |

- Touching the cabinet with any product made from rubber or plastic for a long time may cause degeneration or loss of paint on the cabinet.

CABINET Stains can be removed with a cloth lightly moistened with a mild detergent solvent. Then wipe the cabinet with a soft dry cloth.

LCD Periodic cleaning with a soft dry cloth is recommended.

SCREEN Don't use tissue paper etc. because these will damage the LCD screen.

BEFORE YOU OPERATE THE MONITOR

FEATURES

- ◆ Supports Resolutions up to 1920 × 1080
- ◆ High Contrast 4000:1 (Typical) / Brightness 500cd/m² (Typical: without Touch panel) : ProLite TF4637MSC
- ◆ High Contrast 1100:1 (Typical) / Brightness 500cd/m² (Typical: without Touch panel) : ProLite TF5537MSC
- ◆ Digital Character Smoothing
- ◆ Automatic Set-up
- ◆ Stereo Speakers
2 × 7W Stereo Speakers
- ◆ Plug & Play VESA DDC2B Compliant
Windows[®] XP/Vista/7/8/8.1/10 Compliant
- ◆ Power Management (VESA DPMS Compliant)
- ◆ VESA Mounting Standard (400mm×200mm) Compliant : ProLite TF4637MSC
- ◆ VESA Mounting Standard (600mm×400mm) Compliant : ProLite TF5537MSC
- ◆ Support 24hrs/day usage (by moving picture condition) : ProLite TF5537MSC
- ◆ IPX1 Standard Compliant (Only front face)

CHECKING THE CONTENTS OF THE PACKAGE

The following accessories are included in your package. Check to see if they are enclosed with the monitor. If anything is missing or damaged, please contact your local iiyama dealer or regional iiyama office.

- | | | |
|------------------------------------|--|---------------------|
| ■ Power Cable* | ■ VGA Cable | ■ DVI-D Cable |
| ■ USB Cable | ■ IR Extender Cable | |
| ■ Remote Control (For maintenance) | ■ Button Battery CR2025 (for Remote Control) | |
| ■ Clamper (For tying cables) | ■ Safety Guide | ■ Quick Start Guide |

CAUTION

* The rating of the Power Cable enclosed in 120V area is 10A/125V. If you are using a power supply higher than this rating, then a power cable with a rating of 10A/250V must be used. However, all guarantees and warranties are void for any problems or damage caused by a power cable not supplied by iiyama.

UNPACKING

- ① Before unpacking your monitor, prepare a stable, level, and clean surface near a wall outlet. Set the LCD Monitor box in an upright position and open from the top of the box before removing the top cushions.
- ② Remove the carton holders.
- ③ Remove the top cushion and take the accessories box and the Monitor out.

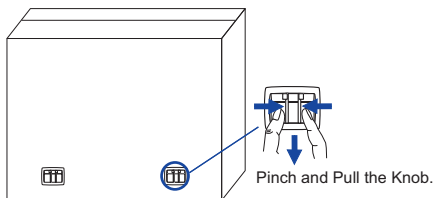

CAUTION

Moving the monitor requires at least two people. If not, it may drop and could result in a serious injury.

When moving/shipping the monitor, please hold by the carton holders.



SPECIAL NOTES ON

CAUTION

Permanent damage can occur if Sharp Edged, Pointed or Metal items are used to activate Touch. This could invalidate any remaining warranty.

We recommend to use a conductive rubber pen (tip $\varnothing 7.0$ or over) or finger.

CONTROLS AND CONNECTORS : MONITOR

<Front>

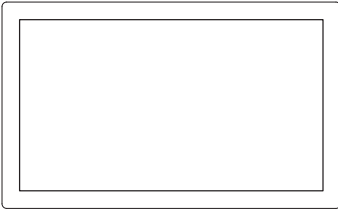

<Back>

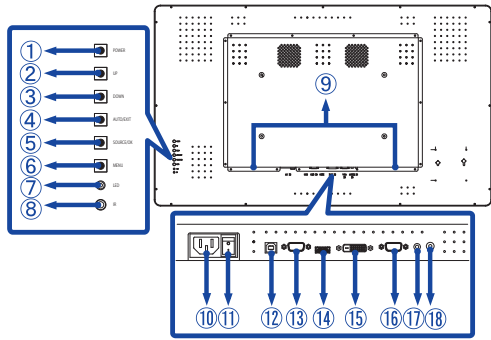

| | | | |
|---|-------------------------------|------------------------|--|
| ① | POWER | Power Button | |
| ② | UP | Up/Volume + Button | |
| ③ | DOWN | Down/Volume - Button | |
| ④ | AUTO / EXIT | Auto/Exit Button | |
| ⑤ | SOURCE / OK | Input Select/OK Button | |
| ⑥ | MENU | Menu Button | |
| ⑦ | LED | Green | Normal Operation |
| | | Orange | Power Management |
| ⑧ | IR | Remote Sensor | |
| ⑨ | SPEAKERS | Speakers | |
| ⑩ | AC IN | AC-INLET | AC Connector(~ : Alternating current) (AC-IN) |
| ⑪ | AC SWITCH — (ON) / ○ (OFF) | MAIN POWER | Main Power Switch |
| ⑫ | USB | USB | Touch USB Connector |
| ⑬ | COM IN | RS232C 9pin | RS232C Connector |
| ⑭ | HDMI | HDMI | HDMI Connector |
| ⑮ | DVI IN | DVI-D | DVI-D Connector |
| ⑯ | VGA IN | VGA | VGA Connector |
| ⑰ | AUDIO IN (PC Audio In) | Mini Jack | Audio Connector |
| ⑱ | IR | Mini Jack | IR Extender Connector |

INSTALLATION

CAUTION

- Follow the manual instructions for the type of mount you have selected. Refer all servicing to qualified service personnel.
- Moving the monitor requires at least two people.
- Before installing, please make sure the wall is strong enough to hold the necessary weight of the display and the mount.

[WALL MOUNTING]

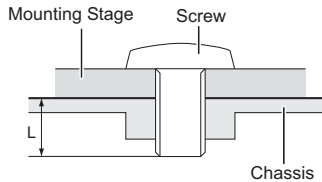

CAUTION

When using the wall mounting, consideration of thickness of the mounting stage needs to be taken. Tighten the M6 Screw with washer which "L" length is 10mm to fasten the monitor. Using a screw longer than this may cause electric shock or damage because it may contact with the electrical parts inside the monitor.

[FAN]

CAUTION

If the screen is used in face-up position, please be sure to turn on the FAN function. If you do not use the FAN, the internal temperature rises and the product life cycle may get shorter. If the screen is built into an external cabinet, please be sure to implement a cooling unit inside of the cabinet. Dirt and dust may stick to the FAN, reducing the cooling effect which may result in a shorter life cycle of the product. Please clean regularly.

[ROTATING THE DISPLAY]

It is designed to be compatible in both landscape and portrait modes.

● ProLite TF4637MSC

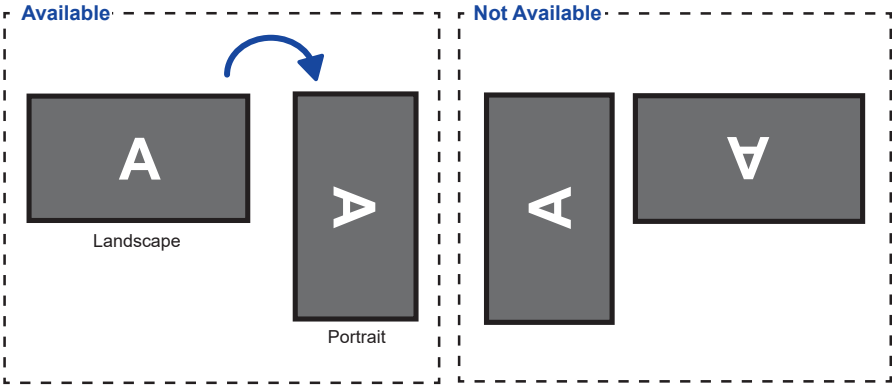

● ProLite TF5537MSC

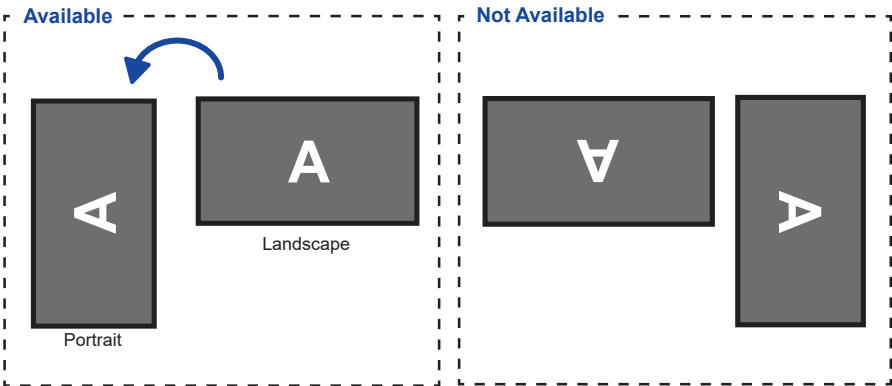

CONTROLS AND CONNECTORS : REMOTE CONTROL (For maintenance)

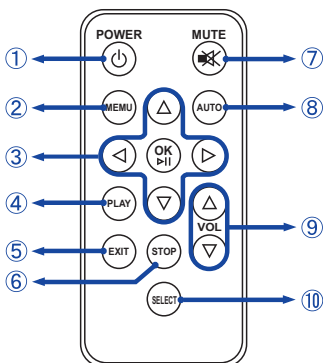

NOTE

To use the remote control we advise you to position it at the back of the monitor (left side) where the remote sensor is located. It might not work if you use it standing in front of the monitor.

| | | |
|---|--------|--|
| ① | POWER | Turns the monitor ON and OFF. |
| ② | MENU | Opens the monitor's on-screen menu systems. When the menu system is already open, pressing this button will select the previous submenu. |
| ③ | ▲▼◀▶ | Navigates through submenus and settings. ▲: Up Button ▼: Down Button ◀: Left Button ▶: Right Button |
| | OK | Confirms your selection or save changes. |
| ④ | PLAY | Not available on this model. |
| ⑤ | EXIT | Returns to a previous menu or closes the OSD Menu. |
| ⑥ | STOP | Not available on this model. |
| ⑦ | MUTE | Turns on or off the mute function when the Menu is not displayed. |
| ⑧ | AUTO | Adjust H. / V. Position, Clock and Phase automatically. |
| ⑨ | VOL | ▲: Increases the sound volume. ▼: Decreases the sound volume. |
| ⑩ | SELECT | Selects the source. |

PREPARING THE REMOTE CONTROL

To use the remote control, insert the button battery.

CAUTION

Do not use any other batteries other than those specified in this manual for the Remote Control. Burst batteries or the electrolyte from these batteries may cause stains, fire or injury.

- ① Push Lock to right and remove the battery case in the direction of the arrow.



- ② Put it in face up the + side of the button battery (CR2025).

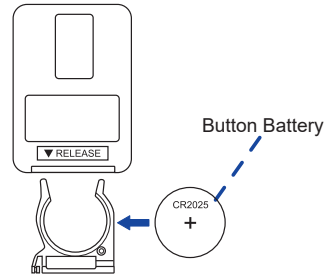

- ③ Replace the battery case in the direction of the arrow.



NOTE

- Replace with new batteries when the Remote Control does not work close to the monitor. Use the button battery (CR2025).
- Operate the Remote Control by pointing it toward the Remote Sensor on the monitor.
- Other manufacturers remote control will not work with this monitor. Use the provided Remote Control ONLY.
- Used batteries needed to follow the local rules to be discarded. (Suggestion: to dispose of used batteries please follow correct policy as per your local regulations.)

BASIC OPERATION

■ Turning the monitor ON

The monitor is on and the Power Indicator turns Green when you press the Power Button on the monitor or the Remote Control. The monitor is off and the Power Indicator turns Orange when you press the Power Button on the monitor or the Remote Control. Press again to turn the monitor on.

NOTE

Even when using the power management mode or turning OFF the Power Switch, the monitor will consume a small amount of electricity. Disconnect the Power Cable from the power supply whenever the monitor is not in use or during the night, to avoid unnecessary power consumption.

[Monitor]

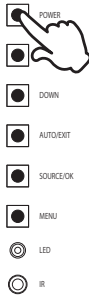

[Remote Control]



■ Display the adjustment menu page

The menu page appears on the screen when you press the MENU Button on the monitor or the Remote Control.

The menu page disappears when you press the EXIT Button on the Monitor or the Remote Control.

[Monitor]

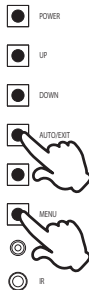

[Remote Control]

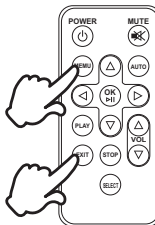

■ **Move the cursor vertically**

Select adjustment by pressing the UP / DOWN Button on the monitor or the ▲ / ▼ Button on the Remote Control while the menu page is displayed on the screen.

[Monitor]

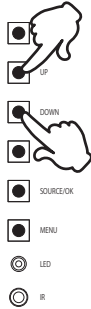

[Remote Control]

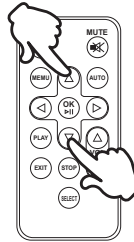

■ **Move the cursor horizontally**

Select menu or setting, or perform the adjustment by pressing the ◀ / ▶ Button on the Remote Control while the menu page is displayed on the screen.

[Remote Control]

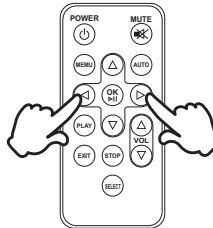

■ Adjust the volume of sound

Press the UP / DOWN Button on the Monitor or the VOL ▲ / ▼ Button on the Remote Control to adjust the volume of sound when the menu page is not displayed on the screen.

[Monitor]

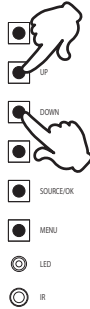

[Remote Control]

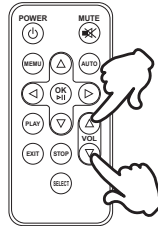

■ Switch the input signal

This is activated when you successively press the SOURCE Button on the monitor or SELECT Button on the Remote Control.

[Monitor]

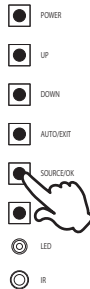

[Remote Control]

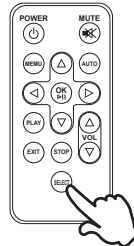

CONNECTING YOUR MONITOR

- ① Ensure that both the computer and the monitor are switched off.
- ② Connect the computer to the monitor with the signal cable.
- ③ Connect the computer to the monitor with the USB Cable.
- ④ Connect the Power Cable to the monitor first and then to the power supply.
- ⑤ Turn on your monitor (Main Power Switch and Power Switch) and computer.

NOTE

- The signal cables used for connecting the computer and monitor may vary with the type of computer used. An incorrect connection may cause serious damage to both the monitor and the computer. The cable supplied with the monitor is for a standard connector. If a special cable is required please contact your local iiyama dealer or regional iiyama office.
- Make sure you tighten the finger screws at each end of the Signal Cable.
- When USB cable connected than wait for 5 seconds and the touch function is ready to go. It can be activated by pen, finger or any other pointer.

[Example of Connection]

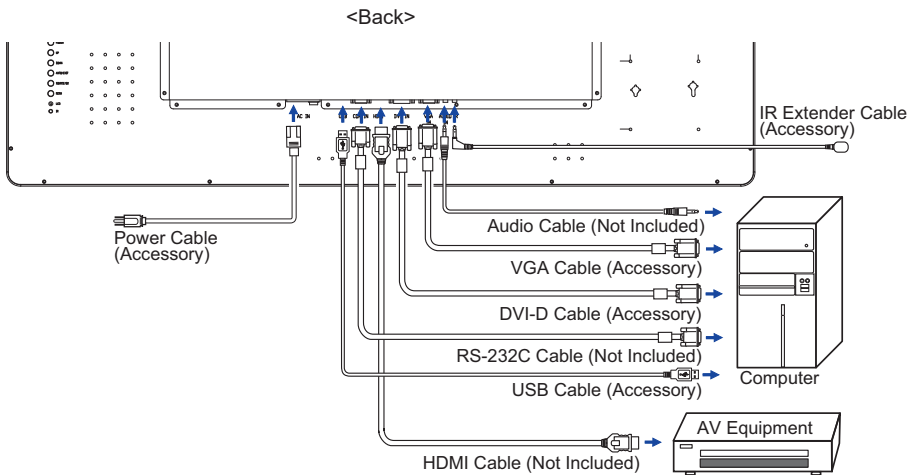

[Collect Cables]

- ① Insert the Clamper into the Hole.
- ② Collect cables at the back.
- ③ Secure the cables using a clamper.

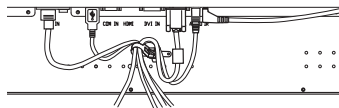

COMPUTER SETTING

■ Signal Timing

Change to the desired signal timing listed on page 34: COMPLIANT TIMING.

■ Windows XP/Vista/7/8/8,1/10 Plug & Play

The iiyama LCD monitor complies with DDC2B of VESA standard. The Plug & Play function runs on Windows XP/Vista/7/8/8,1/10 by connecting the monitor to DDC2B compliant computer with the Signal Cable supplied.

For installation on Windows XP: The monitor Information File for iiyama monitors may be necessary for your computer and obtained via the Internet, using the address:

<http://www.iiyama.com>

NOTE

- For additional information on how to download the driver for your touch screen monitor, please access the internet site noted above.

■ Procedure for turning ON the Power Switch

Turn ON the monitor first, and then the computer.

■ MULTI-TOUCH

This monitor complies with DDC2B of VESA standard. (Plug&play compliant)

The MULTI-TOUCH function runs on Windows7/8/8,1/10 by connecting the monitor to DDC2B compliant computer with the USB cable supplied.

■ MULTI-TOUCH support operation system

Microsoft Windows 7 (64 bit and 32 bit)

Microsoft Windows 8/8,1/10 (64 bit and 32 bit)

Linux (3.8) & above

Not support Windows 2000 and earlier versions.

| | Windows8/8,1/10 | Windows7* ⁵ | Windows7* ⁴ | Linux |
|---------------------------------|-----------------|------------------------|------------------------|-------|
| Default mouse* ¹ | ○ | ○ | ○ | ○ |
| Touch digitizer* ² | ○ | ○ | ○ | × |
| Windows7 gestures* ³ | ○ | ○ | × | × |

*¹ Default mouse (click, drag, double-click and right-click)

*² Touch digitizer (click, drag /selection, double-click, right-click, flick and visual feedback)

*³ Digitizer with Windows7 multi-touch gestures

*⁴ Windows 7 - Starter and Home Basic version

*⁵ Windows 7 - Home Premium, Professional, Enterprise and Ultimate versions

OPERATING THE MONITOR

To create the best picture, your iiyama LCD monitor has been preset at the factory with the COMPLIANT TIMING shown on page 34. You are also able to adjust the picture by following the button operation shown below. For more detailed adjustments, see page 25 for SCREEN ADJUSTMENTS.

- 1 Press the **MENU** Button to start the **On Screen Display** feature. There are additional **Menu items** which can be switched by using the **▲ / ▼** Buttons.



- 2 Select the **Menu item** of the adjustment you want to make. Press the **▶** or **OK** Buttons and enter the menu page. Then, use the **▲ / ▼** Buttons to highlight the desired adjustment item.
- 3 Press the **▶** or **OK** Buttons again. Use the **▲ / ▼** Buttons to make the appropriate adjustment or setting.
- 4 Press the **EXIT** Button to leave the menu, and the settings you just made would be automatically saved.

For example, to correct for vertical position, select Menu item of "Display Settings". Select "V. Position" by using the **▲ / ▼** Buttons. Press the **▶** or **OK** Buttons. Use the **▲ / ▼** Buttons to change the vertical position settings. The vertical position of the overall display should be changing accordingly while you are doing this.

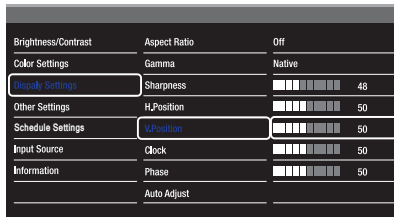

Press the **EXIT** Button lastly, it ends, all changes are saved in the memory.

NOTE

- When button operations are aborted during adjustment, On-Screen Display disappears when the time set for the OSD Timeout has passed.
- The **MENU** / **EXIT** Button can be used to return previous menu item.
- Any changes are automatically saved in the memory when the On Screen Display disappears. Turning off the power should be avoided while using the Menu.
- Adjustments for Image H./V.Position, Clock and Phase are saved for each signal timing. Except for these adjustments, all other adjustments have only one setting which applies to all signal timings.

● **LOCK MODE:** * Available for Back Controller only.









Pressing and holding the MENU button and the Power Switch for about 3 seconds when the Menu is not displayed.

* The OSD menu is not displayed when the OSD is locked. Pressing and holding the MENU button and the Power Switch for about 3 seconds when the Menu is not displayed.





The following OSD menu is displayed.

| Adjustment Item | Problem / Option | |
|-----------------|------------------|---------------------------------|
| OSD | On | The OSD menu is Locked. |
| | Off | The OSD menu is Unlocked. |
| Power Key | On | The POWER SWITCH is Locked. |
| | Off | The POWER SWITCH is Unlocked. |
| Remoto Control | On | The Remote Control is Locked. |
| | Off | The Remote Control is Unlocked. |

ADJUSTMENT MENU CONTENTS

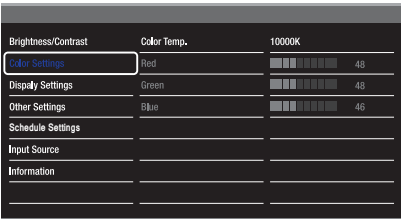
| Brightness/Contrast | | |
|---|------------------|---|
|  | | |
| Adjustment Item | Problem / Option | Button to Press |
| Brightness * | Too dark |   |
| | Too bright |   |
| Contrast | Too dull |   |
| | Too intense |   |

* Adjust the Brightness when you are using the monitor in a dark room and feel the screen is too bright.

| Color Settings | | | |
|---|------------------|--|----------|
|  | | | |
| Adjustment Item | Problem / Option | Button to Press | |
| Color Temp. | 10000k | More bluish white | |
| | 9300k | Bluish white | |
| | 6500k | Reddish white | |
| | USER | RED | Too weak |
| | | GREEN | |
| BLUE | | Too strong | |
| | |     | |

Display Settings

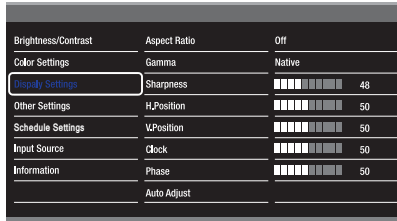

| Adjustment Item | Problem / Option | Button to Press |
|------------------------------|--|---|
| Aspect Ratio | Off | Aspect Ratio is turned off. |
| | 16:10 | Displays all picture in 16:10 aspect ratio. |
| | 5:4 | Displays all picture in 5:4 aspect ratio. |
| | 4:3 | Displays all picture in 4:3 aspect ratio. |
| Gamma | You can set the Gamma. Native / 2.2 / 1.8 | |
| Sharpness | You can change the picture quality from 0 to 100 (soft to sharp). Press the ▲ Button to change the picture quality in numerical order. Press the ▼ Button to change the picture quality in reverse numerical order. | |
| H. Position * ¹ | Too left Too right | ▲ ▼ |
| V. Position * ¹ | Too low Too high | ▲ ▼ |
| Clock * ^{1,3} | Too narrow Too wide | ▲ ▼ |
| Phase * ^{1,3} | To correct flickering text or lines | |
| Auto Adjust * ^{1,2} | Adjust H./V. Position, Clock and Phase automatically. | |

*¹ Only Analog input.

*² For best results, use the Auto Adjust in conjunction with the adjustment pattern. See page 25 for SCREEN ADJUSTMENTS.

*³ See page 25 for SCREEN ADJUSTMENTS.

Other Settings

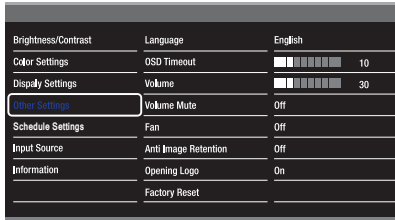

| Adjustment Item | Problem / Option | | | Button to Press |
|------------------------------|---|---|------------|-----------------|
| Language | English | English | Nederlands | Dutch |
| | Français | French | Poliski | Polish |
| | Español | Spanish | Русский | Russian |
| | Deutsch | German | Italiano | Italian |
| OSD time out | You can set the OSD display duration time between 5 and 30 seconds. | | | |
| Volume | Too soft | | | |
| | Too loud | | | |
| Mute | On | Turn off the sound temporarily. | | |
| | Off | Return the sound volume to the previous level. | | |
| Fan * ¹ | On | Fan is turned on. | | |
| | Off | Fan is turned off. | | |
| Anti Image Retention | On | Automatically displays moving patterns (shifting by 2 pixels) to prevent image retention on the screen. | | |
| | Off | Anti Image Retention is turned off. | | |
| Opening Logo | On | iiyama Logo displayed when the monitor is turned on. | | |
| | Off | iiyama Logo does not display when the monitor is turned on. | | |
| Factory Reset * ² | Factory-preset data is restored. | | | |

*¹ If the screen is used in face-up position, please be sure to turn on the FAN function.

*² When the Factory Reset is being performed, the Schedule Settings will also be reset.

Schedule Settings

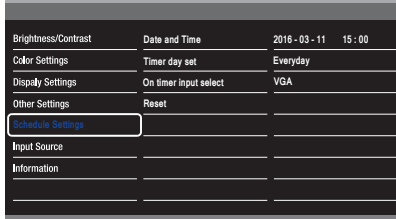

| Adjustment Item | Problem / Option | | Button to Press |
|-----------------------|---|--|-------------------------|
| Date and Time | Adjust the current date and time for the internal clock. Date / Time | | |
| Timer day set * | Sets a recurring schedule. Everyday / Sun / Mon / Tue / Wed / Thu / Fri / Sat | | |
| | Activation | On | Schedule is turned on. |
| | | Off | Schedule is turned off. |
| | On Time Off Time | Set the time for the display to turn on and turn off. | |
| On timer input select | Select default input source to use when the display is automatically turned on next time. VGA / DVI / HDMI | | |
| Reset | On | Schedule Settings will be restored to factory-preset data. | |
| | Off | Return to Menu. | |

* To activate the option, mark it in the setup menu. To deactivate it, remove the marking.

Input Source

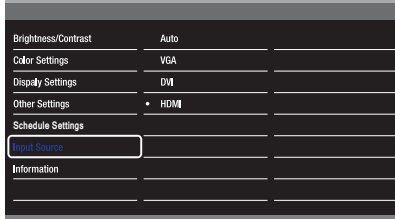

| Adjustment Item | Problem / Option | | Button to Press |
|-----------------|------------------|--|-----------------|
| Input Source | AUTO | Select the signal input automatically. | |
| | VGA | Select the analog input. | |
| | DVI | Select the digital(DVI) input. | |
| | HDMI | Select the digital(HDMI) input. | |

NOTE When only one of the three signal inputs is connected to the signal source, the one connected is automatically selected. Input Source function is not available if there is no signal input from the selected connector or during the power management mode.

Information

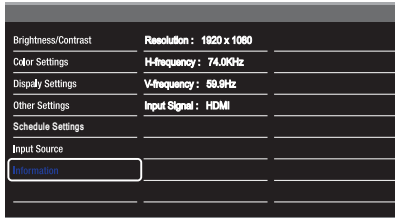

Displays information regarding the current input signal coming from the graphic card in your computer.

NOTE See your graphic card user guide for more information about changing the resolution and refresh.

SCREEN ADJUSTMENTS

Adjust the image by following the procedure below to get the desired picture when selecting Analog input.

- The screen adjustments described in this manual are designed to set image position and minimize flicker or blur for the particular computer in use.
- The monitor is designed to provide the best performance at resolution of 1920 × 1080, but can not provide the best at resolutions of less than 1920 × 1080 because the picture is automatically stretched to fit the full screen. It is recommended to operate at resolution of 1920 × 1080 in normal use.
- Displayed text or lines will be blurred or irregular in thickness when the picture is stretched due to the screen enlargement process.
- It is preferable to adjust the image position and frequency with the monitor controls, rather than the computer software or utilities.
- Perform adjustments after a warm-up period of at least thirty minutes.
- Additional adjustments may be required after the Auto Adjust depending on the resolution or signal timing.
- The Auto Adjust may not work correctly when displaying the picture other than the screen adjustment pattern. In this case, manual adjustments are required.

There are two ways to adjust the screen. One way is automatic adjustment for Position, Clock and Phase. The other way is performing each adjustment manually.

Perform the Auto Adjust first when the monitor is connected to a new computer, or resolution is changed. If the screen has a flicker or blur, or the picture does not fit in the display area after performing the Auto Adjust, manual adjustments are required. Both adjustments should be made by using the screen adjustment pattern (Test.bmp) obtained via the IYAMA web site (<http://www.iiyama.com>).

Adjust the image by following the procedure below to get the desired picture.

This manual explains adjustment under Windows® OS.

- ① **Display the picture at the optimum resolution.**
- ② **Enter the Test.bmp (screen adjustment pattern) to wallpaper.**

NOTE

- Consult the appropriate documentation for doing this.
- Test.bmp is made at resolution of 1280 × 1024. Set the display position to center in the wallpaper setting dialogue box. If you use Microsoft® PLUS! 95/98 cancel the setting of "Stretch desktop wallpaper to fit the screen".

[Adjustment pattern]

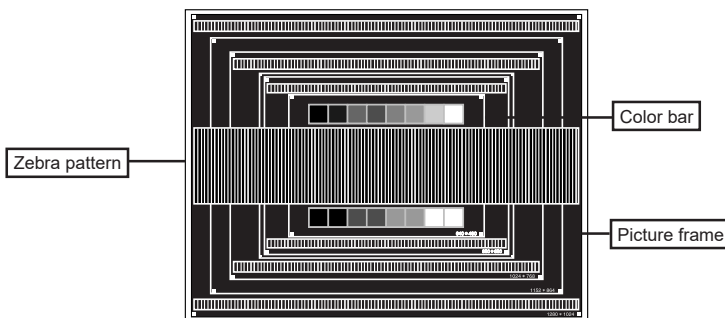

- ③ Adjust the Auto Adjustment.
- ④ Adjust the image manually by following procedure below when the screen has a flicker or blur, or the picture does not fit in the display area after performing the Auto Adjust.
- ⑤ Adjust the V-Position so that the top and bottom of the picture frame will fit to the display area.

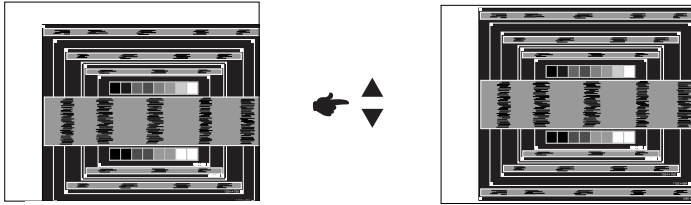

- ⑥ 1) Adjust the H-Position so that the left side of the picture frame will move to the left edge of the display area.

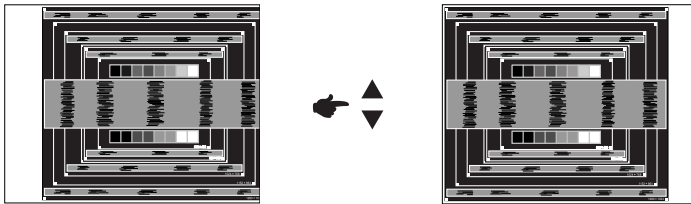

- 2) Stretch the right side of the picture frame to the right edge of the display area by adjusting the Clock.

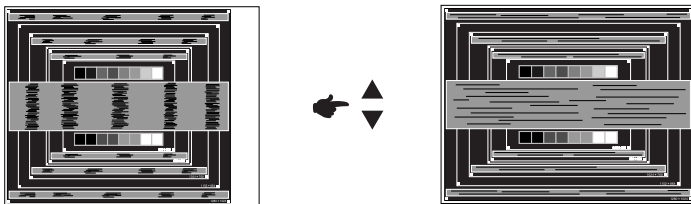
**NOTE**

- When the left side of the picture frame moves apart from the left edge of the display area during the Clock adjustment, adjust steps 1) and 2).
- Another way to make the Clock adjustment is to correct the vertical wavy lines in the zebra pattern.
- The picture may flicker during the Clock, H/V-Position adjustment.
- In case the picture frame is bigger or smaller than the data display area after the Clock adjustment, repeat steps from ③.

⑦ Adjust the Phase to correct horizontal wavy noise, flicker or blur in the zebra pattern.

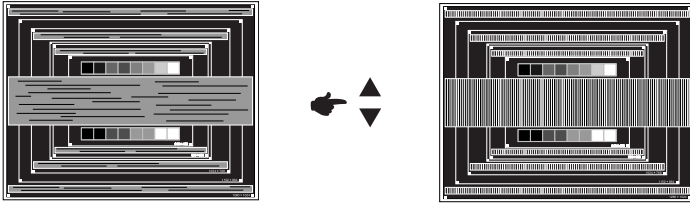

NOTE

- In case the strong flicker or blurs remain on a part of the screen, repeat steps ⑥ and ⑦ because the Clock may not be adjusted correctly. If the flicker or blurs still remain, set the refresh rate of computer to low (60Hz) and repeat steps from ③ again.
- Adjust the H-Position after the Phase adjustment if the horizontal position moves during the adjustment.

⑧ Adjust the Brightness and Color to get the desired picture after you complete the Clock and Phase adjustments.

Put back your favorite wallpaper.

POWER MANAGEMENT FEATURE

The power management feature of this product complies with power saving requirement of VESA DPMS. When activated, it automatically reduces unnecessary power consumption of the monitor when your computer is not in use.

To use the feature, the monitor needs to be connected to a VESA DPMS compliant computer. There is a power management step the monitor takes as described below. The power management function, including any timer settings is configured by the operating system. Check your operating system manual for information on how this can be configured.

■ Power Management Mode

When the H-sync signal / V-sync signal / H and V sync signals from the computer are off, the monitor enters into Power Management Mode which reduces the power consumption to less than 0.5W. The screen becomes dark. From Power Management Mode, the image reappears in several seconds when either the keyboard or the mouse are touched again.

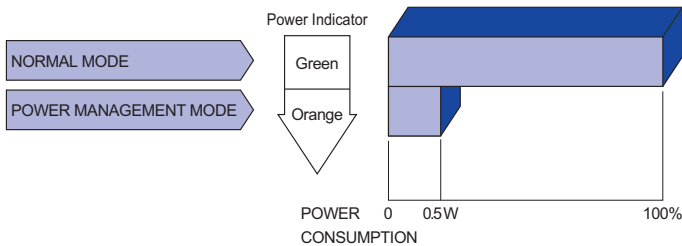

NOTE

- Even when using the power management mode, the monitor consumes electricity. Turn off the Power Switch whenever the monitor is not in use, during the night and weekends, to avoid unnecessary power consumption.
- It is possible that the video signal from the computer may be on while the H or V sync signal is missing. In this instance, the POWER MANAGEMENT feature may not work properly.

TROUBLE SHOOTING

If the monitor fails to operate correctly, please follow the steps below for a possible solution.

1. Perform the adjustments described in OPERATING THE MONITOR, depending on the problem you have. If the monitor does not get a picture, skip to 2.
2. Consult the following items if you cannot find an appropriate adjustment item in OPERATING THE MONITOR or if the problem persists.
3. If you are experiencing a problem which is not described below or you cannot correct the problem, discontinue using the monitor and contact your dealer or iiyama service center for further assistance.

| Problem | Check |
|---|--|
| ① The picture does not appear. | <input type="checkbox"/> The Power Cable is firmly seated in the socket. <input type="checkbox"/> The Power Switch is turned ON. <input type="checkbox"/> The AC socket is live. Please check with another piece of equipment. <input type="checkbox"/> If the blank screen saver is in active mode, touch the keyboard or the mouse. <input type="checkbox"/> Increase the Contrast and/or Brightness. <input type="checkbox"/> The computer is ON. <input type="checkbox"/> The Signal Cable is properly connected. <input type="checkbox"/> The signal timing of the computer is within the specification of the monitor. <input type="checkbox"/> If the monitor is in power management mode, touch the keyboard or the mouse. |
| ② The screen is not synchronized. | <input type="checkbox"/> The Signal Cable is properly connected. <input type="checkbox"/> The signal timing of the computer is within the specification of the monitor. <input type="checkbox"/> The video output level of the computer is within the specification of the monitor. |
| ③ The screen position is not in the center. | <input type="checkbox"/> The signal timing of the computer is within the specification of the monitor. |
| ④ The screen is too bright or too dark. | <input type="checkbox"/> The video output level of the computer is within the specification of the monitor. |
| ⑤ The screen is shaking. | <input type="checkbox"/> The power voltage is within the specification of the monitor. <input type="checkbox"/> The signal timing of the computer is within the specification of the monitor. |
| ⑥ No sound. | <input type="checkbox"/> The audio equipment (computer etc.) is ON. <input type="checkbox"/> The Audio Cable is properly connected. <input type="checkbox"/> The Volume is turned up. <input type="checkbox"/> The Mute is OFF. <input type="checkbox"/> The audio output level of the audio equipment is within the specification of the monitor. |
| ⑦ The sound is too loud or too quiet. | <input type="checkbox"/> The audio output level of the audio equipment is within the specification of the monitor. |
| ⑧ A strange noise is heard. | <input type="checkbox"/> The Audio Cable is properly connected. |
| ⑨ The touch screen shows no response. | <input type="checkbox"/> The USB Cable is firmly seated in the socket. <input type="checkbox"/> Touch screen driver software is installed. |
| ⑩ The touch position does not deviate. | <input type="checkbox"/> The calibration function set up correctly. |

RECYCLING INFORMATION

For better environment protection please don't dispose your monitor.
Please visit our web site: www.iiyama.com/recycle for monitor recycling.

ENGLISH

APPENDIX

Design and specifications are subject to change without prior notice.

SPECIFICATIONS : ProLite TF4637MSC

| | | |
|------------------------------|----------------------|---|
| Touch Screen | Technology | Projected Capacitive 12points |
| | Light transmission | 84% |
| | Hardness | 6H |
| | Thickness | 5mm |
| | Communication system | USB serial transfer |
| Size Category | | 46" |
| LCD Panel | Panel technology | MVA |
| | Size | Diagonal: 46" (116.8cm) |
| | Pixel pitch | 0.53025mm H × 0.53025mm V |
| | Brightness | 500cd/m ² (Typical: without Touch panel), 420cd/m ² (Typical: with Touch panel) |
| | Contrast ratio | 4000 : 1 (Typical) |
| | Viewable angle | Horizontal : 178 degrees, Vertical: 178 degrees (Typical) |
| | Response time | 6.5ms (Gray to Gray) |
| Display Colors | | Approx. 16.7M |
| Sync Frequency | | Analog: Horizontal: 31.47-67.50kHz, Vertical: 47-63Hz Digital: Horizontal: 15.62-67.50kHz, Vertical: 24-60Hz |
| Maximum Resolution | | 1920 × 1080, 2.1 MegaPixels |
| Input Connector | | VGA, DVI-D, HDMI |
| Input Audio Connector | | ø 3,5mm mini jack (Stereo) |
| Serial Port | | RS-232C |
| Plug & Play | | VESA DDC2B™ |
| Input Sync Signal | | Separate sync: TTL, Positive or Negative |
| Input Video Signal | | Analog: 0.7Vp-p (Standard), 75Ω, Positive Digital: DVI (Digital Visual Interface Standard Rev.1.0) compliance Digital: HDMI |
| Input Audio Signal | | 1.0Vrms maximum |
| Speakers | | 7W×2 (Stereo speakers) |
| IR Connector | | IR Extender |
| Maximum Screen Size | | 1018.08mm W × 572.67mm H / 40.1" W × 22.5" |
| Power Source | | 100-240VAC, 50/60Hz, 1.0A |
| Power Consumption*1 | | 90W typical, Power management mode: 0.5W maximum Energy Efficiency Class: B |
| Dimensions / Net Weight | | 1100.0 × 654.5 × 89.0mm / 43.3 × 25.8 × 3.5" (W×H×D) 34.0kg / 74.9lbs |
| Environmental Considerations | | Operating: Temperature 0 to 40°C / 32 to 104°F Humidity 85% (No condensation) Storage: Temperature -20 to 60°C / 4 to 140°F Humidity 85% (No condensation) |
| Approvals | | CE, TÜV-Bauart, CU, IPX1*2 |

NOTE *1 USB peripherals / Audio equipment are not connected.

*2 IPX1 Standard Compliant : Only front face

SPECIFICATIONS : ProLite TF5537MSC

| | | |
|------------------------------|----------------------|---|
| Touch Screen | Technology | Projected Capacitive 12points |
| | Light transmission | 84% |
| | Hardness | 6H |
| | Thickness | 5mm |
| | Communication system | USB serial transfer |
| Size Category | | 55" |
| LCD Panel | Panel technology | IPS |
| | Size | Diagonal: 55" (138.8cm) |
| | Pixel pitch | 0.4833mm H × 0.4833mm V |
| | Brightness | 500cd/m ² (Typical: without Touch panel), 420cd/m ² (Typical: with Touch panel) |
| | Contrast ratio | 1100 : 1 (Typical) |
| | Viewable angle | Horizontal : 178 degrees, Vertical: 178 degrees (Typical) |
| | Response time | 12ms (Gray to Gray) |
| Display Colors | | Approx.16.7M |
| Sync Frequency | | Analog: Horizontal: 31.47-67.50kHz, Vertical: 47-63Hz Digital: Horizontal: 15.62-67.50kHz, Vertical: 24-60Hz |
| Maximum Resolution | | 1920 × 1080, 2.1 MegaPixels |
| Input Connector | | VGA, DVI-D, HDMI |
| Input Audio Connector | | ø 3,5mm mini jack (Stereo) |
| Serial Port | | RS-232C |
| Plug & Play | | VESA DDC2B™ |
| Input Sync Signal | | Separate sync: TTL, Positive or Negative |
| Input Video Signal | | Analog: 0.7Vp-p (Standard), 75Ω, Positive Digital: DVI (Digital Visual Interface Standard Rev.1.0) compliance Digital: HDMI |
| Input Audio Signal | | 1.0Vrms maximum |
| Speakers | | 7W×2 (Stereo speakers) |
| IR Connector | | IR Extender |
| Maximum Screen Size | | 1209.6mm W × 680.4mm H / 47.6" W × 26.8" H |
| Power Source | | 100-240VAC, 50/60Hz, 1.2A |
| Power Consumption*1 | | 76W typical, Power management mode: 0.5W maximum Energy Efficiency Class: B |
| Dimensions / Net Weight | | 1294.5 × 765.5 × 67.5mm / 51.0 × 30.1 × 2.6" (W×H×D) 45.7kg / 100.7lbs |
| Environmental Considerations | | Operating: Temperature 0 to 40°C / 32 to 104°F Humidity 85% (No condensation) Storage: Temperature -20 to 60°C / 4 to 140°F Humidity 85% (No condensation) |
| Approvals | | CE, TÜV-Bauart, CU, IPX1*2 |

NOTE *1 USB peripherals / Audio equipment are not connected.

*2 IPX1 Standard Compliant : Only front face

DIMENSIONS : ProLite TF4637MSC

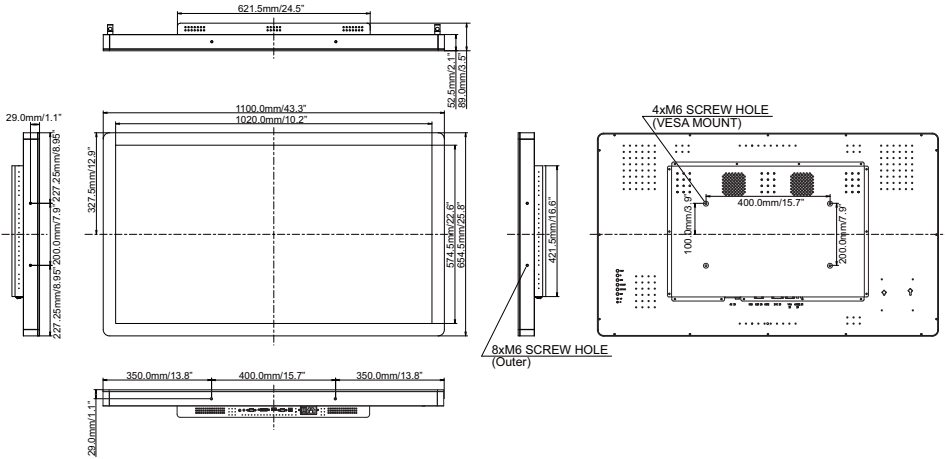

ENGLISH

DIMENSIONS : ProLite TF5537MSC

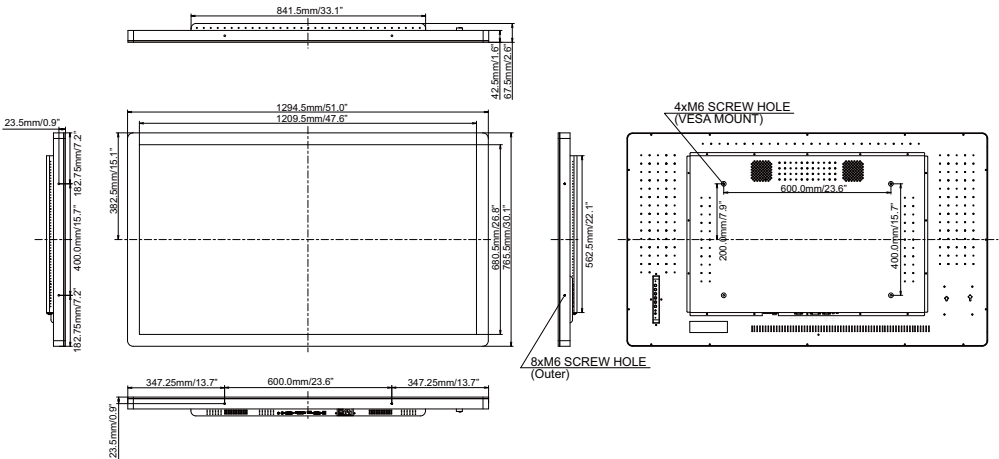

COMPLIANT TIMING

| Video Mode | | | Horizontal Frequency | Vertical Frequency | Dot Clock | |
|------------|-------------|-------------|----------------------|--------------------|------------|----|
| VESA | VGA | 640 × 480 | 31.469kHz | 59.940Hz | 25.175MHz | |
| | | 720 × 400 | 31.467kHz | 70.080Hz | 28.320MHz | |
| | SVGA | 800 × 600 | 37.879kHz | 60.317Hz | 40.000MHz | |
| | XGA | 1024 × 768 | 48.363kHz | 60.004Hz | 65.000MHz | |
| | | 1280 × 720 | 44.720kHz | 60.000Hz | 74.500MHz | |
| | | 1280 × 768 | 47.776kHz | 59.870Hz | 79.500MHz | |
| | SXGA | 1280 × 1024 | 63.981kHz | 60.020Hz | 108.000MHz | |
| | | 1366 × 768 | 47.712kHz | 59.790Hz | 85.500MHz | |
| | WSXGA+ | 1680 × 1050 | 65.290kHz | 59.954Hz | 146.250MHz | |
| Full HD | 1920 × 1080 | 67.500kHz | 60.000Hz | 148.500MHz | | |
| SD | 480i | 60Hz | 15.735kHz | 59.940Hz | 13.500MHz | *2 |
| | 576i | 50Hz | 15.625kHz | 50.000Hz | 13.500MHz | *2 |
| | 480p | 60Hz | 31.469kHz | 59.940Hz | 27.000MHz | *1 |
| | 576p | 50Hz | 31.250kHz | 50.000Hz | 27.000MHz | *1 |
| HD | 720p | 50Hz | 37.500kHz | 50.000Hz | 74.250MHz | *1 |
| | 720p | 60Hz | 45.000kHz | 60.000Hz | 74.250MHz | *1 |
| | 1080i | 50Hz | 28.125kHz | 50.000Hz | 74.250MHz | *1 |
| | 1080i | 60Hz | 33.750kHz | 60.000Hz | 74.250MHz | *1 |
| | 1080p | 24Hz | 27.000kHz | 24.000Hz | 74.250MHz | *1 |
| | 1080p | 30Hz | 33.750kHz | 30.000Hz | 74.250MHz | *1 |
| | 1080p | 50Hz | 56.250kHz | 50.000Hz | 148.500MHz | *1 |
| | 1080p | 60Hz | 67.500kHz | 60.000Hz | 148.500MHz | *1 |

NOTE *1 DVI/HDMI input only.

*2 HDMI input only.