

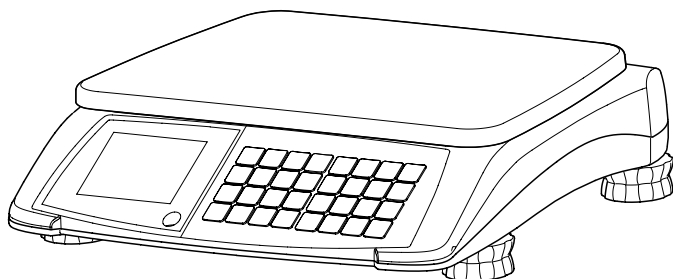

Operator Manual

# **OHAUS Aviator 7000**





# Contents

<b>1</b>	<b>Your new retail scale .....</b>	<b>5</b>
1.1	Most important functions .....	5
1.2	Device overview .....	5
1.3	Definition of signal warnings and symbols .....	8
1.4	Safety precautions .....	9
<b>2</b>	<b>Setting up .....</b>	<b>10</b>
2.1	Scope of delivery .....	10
2.2	Requirements for scale's location .....	10
2.3	Setting up the scale .....	10
2.4	Inserting the batteries .....	11
2.5	Connecting to mains power .....	12
2.6	Turning scale on/off .....	12
2.7	Cleaning .....	12
<b>3</b>	<b>Operation .....</b>	<b>13</b>
3.1	Free input .....	13
3.2	Working with PLUs .....	13
3.3	Using tare .....	17
3.4	Zeroing .....	18
3.5	By-count operation .....	18
3.6	Accumulating .....	19
3.7	Change function .....	20
3.8	Fix unit price and/or tare .....	21
3.9	Hold function .....	22
3.10	Weighing with 100 g (1/2 lb / 1/4 lb) price unit .....	22
3.11	Switching weighing unit between kg and lb .....	23
3.12	Displaying the price to pay in EURO .....	23
3.13	Backlight function .....	23
3.14	Ticket printing .....	24
3.15	Printing reports .....	26

<b>4</b>	<b>Operator setup .....</b>	<b>28</b>
4.1	Setup operation .....	28
4.2	Operator setup overview .....	29
4.3	Setting date and time .....	32
<b>5</b>	<b>What do you do if....? .....</b>	<b>33</b>
<b>6</b>	<b>Technical data and accessories .....</b>	<b>34</b>
6.1	Technical data .....	34
6.2	Accessories .....	35
6.3	Compliance .....	35
6.4	Important notice for verified weighing instruments used in Europe .....	36
6.5	Legal for Trade .....	36
<b>7</b>	<b>Annexe .....</b>	<b>37</b>
7.1	Disposal in Europe .....	37
7.2	FCC Note .....	37
7.3	ISO 9001 Registration .....	38

# 1 Your new retail scale

## 1.1 Most important functions

Congratulations on your new scale.

This robust digital price computing scale with its hygienic design and battery operation facilitates comfortable mobile selling while maintaining the highest accuracy.

POS connectivity provides external printing and/or data transfer with multiple protocols.

## 1.2 Device overview

The scale is available in two versions: as a compact scale or as a tower version.

### 1.2.1 Keyboard

The keyboard is divided into four sections. The advanced function keys depend on the region.

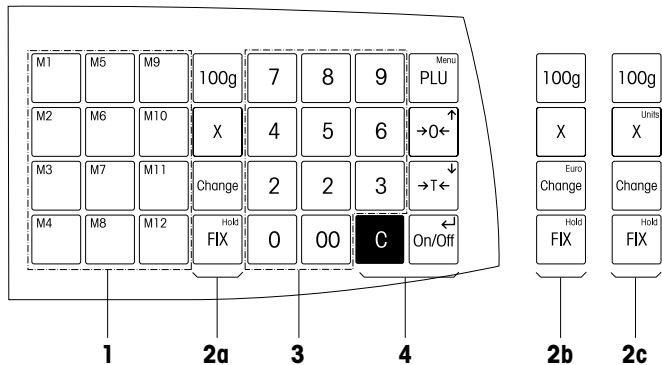

- 1** PLU preset keys
- 2a** Advanced function keys, Basic (rest of the world)
- 2b** Advanced function keys, Europe
- 2c** Advanced function keys, North America
- 3** Numeric keypad
- 4** Basic function keys

## Display

The display is laid out as follows from the customer and vendor point of view. Unit and currency will vary according to the region.

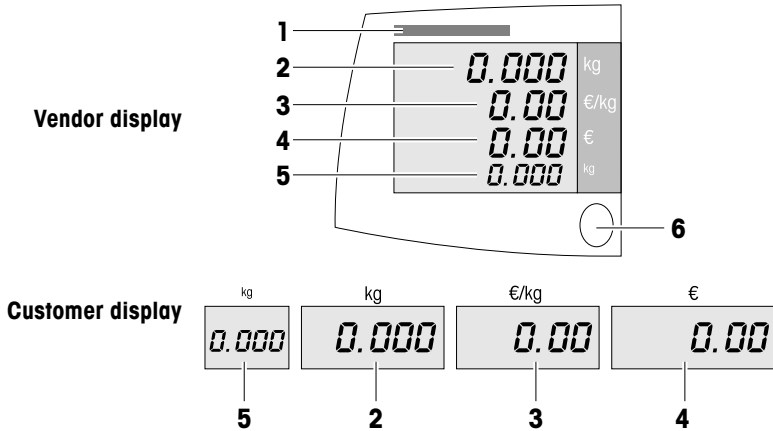

- 1 Capacity information
- 2 Weight display
- 3 Unit price
- 4 Price
- 5 Preset tare
- 6 Level indicator

In addition to the weight and price, the following status messages and indicators can be displayed:

- ZERO** Scale is at center of zero
- PT** Keyboard tare or tare recalled from PLU
- NET** Net value (gross minus tare); push button tare exists
- FIX** Unit price and/or tare is fixed
- X** Scale is in by-count mode
- 100 g** 100 g pricing is activated
- 1/2** 1/2 lb pricing is activated
- 1/4** 1/4 lb pricing is activated
- Add** Scale is in accumulation mode; data exists in the accumulation memory
- Total** The displayed total price is added into the accumulation memory
- Battery is approx. full
- 2/3 battery power left
- 1/3 battery power left
- Battery power at a critical level

## 1.2.2

### Connections and features on the underside

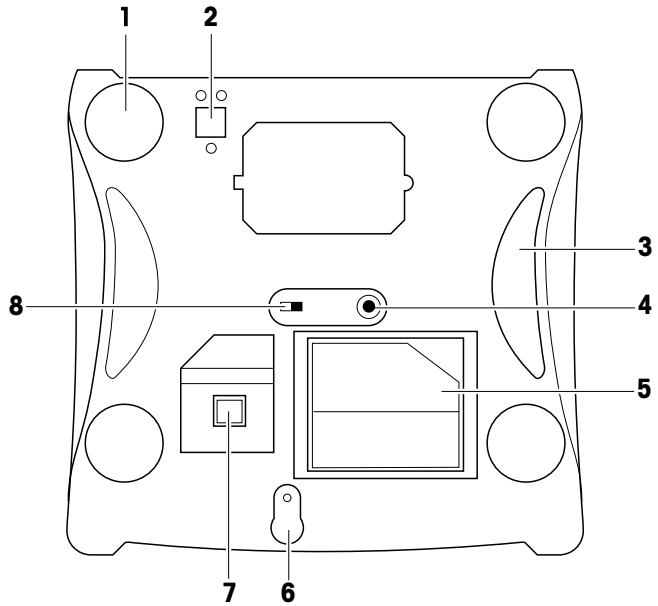

The following connections are located on the underside of the scale:

- 1 Adjustable feet
- 2 Tower mounting
- 3 Grips
- 4 Power supply connection
- 5 Power supply storage box
- 6 Calibration button
- 7 Interface connection; RS232/USB, depending on cable
- 8 Battery switch: NiMH (rechargeable) – D-cell (non-rechargeable)

### 1.3 Definition of signal words and warning symbols

Safety notes are marked with signal words and warning symbols. These show safety issues and warnings. Ignoring the safety notes may lead to personal injury, damage to the instrument, malfunctions and false results.

#### 1.3.1 Signal words

**WARNING** For a hazardous situation with medium risk, possibly resulting in injuries or death if not avoided

**CAUTION** For a hazardous situation with low risk, resulting in damage to the device or the property or in loss of data, or injuries if not avoided

**Attention** For important information about the product

**Note** For useful information about the product

#### 1.3.2 Warning Symbols



General hazard



Electrical shock hazard



## 1.4

### Safety precautions



#### CAUTION

Read all safety warnings before installing, making connections, or servicing the equipment. Failure to comply with these warnings could result in personal injury and/or property damage. Retain all instructions for future reference.

- ▶ Verify that the AC adapter's input voltage range and plug type are compatible with the local AC power to be used.
- ▶ Do not position the balance such that it is difficult to disconnect the AC adapter from the power receptacle.
- ▶ Make sure that the power cord does not pose a potential obstacle or tripping hazard.
- ▶ The balance is for indoor use only. Use the balance only in dry locations.
- ▶ Do not drop loads on the weighing pan.
- ▶ Use only approved accessories and peripherals.
- ▶ Operate the equipment only under ambient conditions specified in these instructions.
- ▶ Disconnect the equipment from the power supply when cleaning.
- ▶ Do not operate the equipment in hazardous or unstable environments.
- ▶ Service should only be performed by authorized personnel.

## 2 Setting up

### 2.1 Scope of delivery

- ▶ Check if the delivery is complete:
  - Scale
  - Stainless steel weighing pan
  - Power supply, stored in the power supply storage compartment under the scale
  - Operating instructions
  - Tower with mounting material, tower version only

### 2.2 Requirements for scale's location

The right location is critical to weighing accuracy.

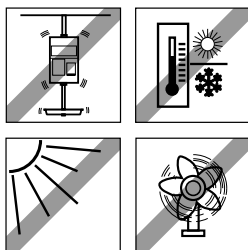

#### Conditions for an ideal location

- No shocks and vibrations
  - No excessive temperature fluctuations
  - No direct sunlight
  - No strong drafts
- Select a stable, vibration-free and preferably horizontal location for your scale.

### 2.3 Setting up the scale

#### 2.3.1 Levelling the scale

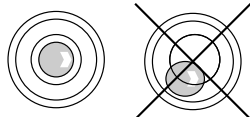

Only a perfectly levelled scale delivers accurate weighing results. The scale is equipped with a level indicator to make it easier to level the scale.

- ▶ To level the scale, turn the scale's adjustable feet until the air bubble in the level indicator is in the inner circle.

### 2.3.2

#### Mounting the tower

With the tower version the customer display is at eye level.  
The tower must be mounted first.

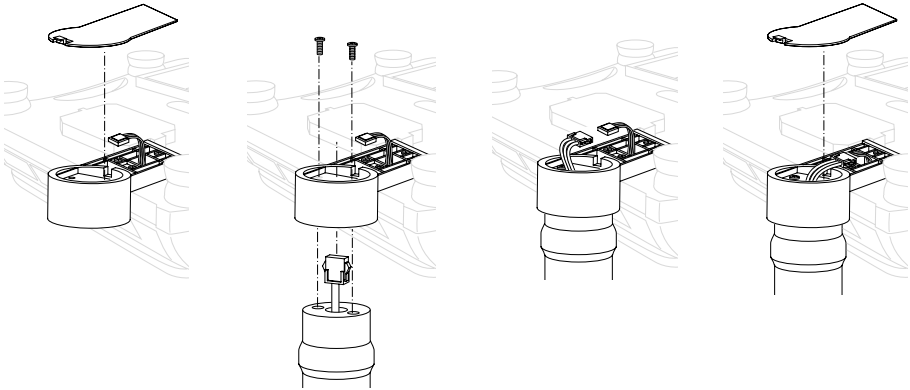

1. Remove the weighing pan and turn over the scale.
2. Open the tower base cover.
3. Route the cable from the tower through the tower base.
4. Put the tower on the tower base and fix it with two screws.
5. Clip the cable connectors together.
6. Put the cables and connectors in the tower base.
7. Close the tower base cover.
8. Turn over the scale and put the weighing pan back on.

### 2.4

#### Inserting the batteries

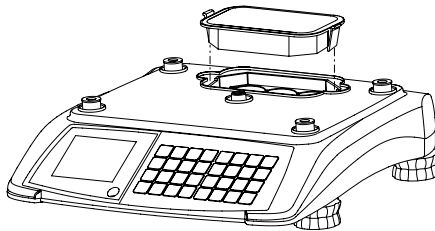

1. Make sure that the external power supply is disconnected.
2. Remove the weighing pan.
3. Remove the battery compartment cover.
4. Turn over the scale and ensure that the battery switch is set to the correct position:
  - for rechargeable D-cell batteries: "NiMH".
  - for non-rechargeable D-cell batteries: "Battery".

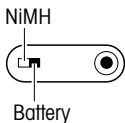

**WARNING**

Risk of explosion when the battery switch is not set correctly.

- ▶ Make sure that the battery switch is in the right position for the desired type of battery.
5. Turn over the scale.
  6. Place the batteries in the compartment so that the positive poles face the springs, see pole markings on cover and housing.
  7. Close the battery compartment and put the weighing pan back on.

**2.5****Connecting to mains power**

The power supply is stored in a compartment under the scale to support save transport.

1. Connect the supplied power supply unit to the power connection socket on the underside of the scale.
2. Plug the power supply unit into a correctly grounded power outlet.

**2.6****Turning scale on/off**

- ▶ To turn the scale on press the **On/Off** key.
- ▶ To turn the scale off press and hold the **On/Off** key until a long beep can be heard.



- After the scale is turned on, it runs through a short display test. All segments and status messages briefly light up, the software version is displayed.
- The scale is ready when the weight display appears.

**2.7****Cleaning****WARNING**

- ▶ Disconnect the AC adapter from the AC power supply and the balance before cleaning.
- ▶ Do not allow liquids to enter the AC adapter or the balance.

**Cleaning**

If cleaning is required, use a soft cloth dampened with water and a mild detergent.

**Attention**

Do not use harsh chemicals to clean the balance, as the finish may be damaged.

## 3 Operation

### 3.1



0 ... 9

#### Free input

You can immediately use your scale for weighing and selling – without prior configuration.

1. Place the item on the scale.
2. Enter the unit price.  
The price to pay is displayed.
3. Remove the item from the scale.  
All displays return to 0.



Enter the unit price as usual without the decimal point, but with all the decimal places.

### 3.2

#### Working with PLUs

You can save the price and/or tare for frequently sold goods in the scale's PLU memory and simply call it up later.

In the factory setting unit price and tare are saved in a PLU.

#### 3.2.1

#### Creating a PLU

0 ... 9

PLU



P

0 ... 9



1. Enter the unit price.
2. Press and hold the **PLU** key until a long beep can be heard.  
P appears in the weight display.
3. Enter the PLU number (between 1 and 9999).
4. Wait until the scale beeps twice.  
The PLU is stored and all displays return to 0.



- To save the tare weight in the PLU: before entering the unit price, first tare the corresponding container, see section 3.3.
- The scale can store 100 PLUs. If the memory is full and you want to store a new PLU the messages "Full" and "Delete" are displayed. You can either overwrite a specific PLU or delete the whole PLU memory.
  - To overwrite an existing PLU press the **C** key and create a new PLU with the number you want to overwrite.
  - To delete the whole PLU memory press the **Enter** (On/Off) key.

### 3.2.2

#### Calling up PLUs

Depending on the setting of operator setup Step 7, there are two ways to call up PLUs.



0 ... 9 **PLU**

#### Calling up via PLU key (factory setting, operator setup Step 7 = OFF)

1. Place the item on the scale.
2. Enter the corresponding PLU number and press the **PLU** key. Unit price and price to pay are displayed.
3. Remove the item from the scale. All displays return to 0.



0 ... 9

#### Calling up PLU automatically (operator setup Step 7 = ON)

1. Place the item on the scale.
2. Enter the corresponding PLU number. The PLU is called up automatically. Unit price and price to pay are displayed.
3. Remove the item from the scale. All displays return to 0.

### 3.2.3 Using PLU preset keys

You can save the most important PLUs to the keys in the left-hand key field.

Depending on the setting of operator setup Step 14, one or two PLUs can be assigned to a PLU preset key.

#### PLU preset keys with one PLU (operator setup Step 14 = OFF)

##### Storing one PLU to a preset key

1. Enter the unit price or recall PLU.
2. Press and hold the desired preset key, e.g., **M1**, until a long beep can be heard.  
Two short beeps indicate that the data has been stored.

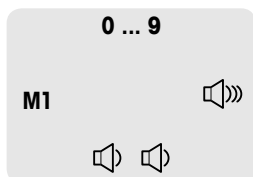

##### Calling up PLUs with preset keys

1. Place the item on the scale.
2. Press the corresponding preset key, e.g., **M1**.  
Unit price and price to pay are displayed.
3. Remove the item from the scale.  
All displays return to 0.

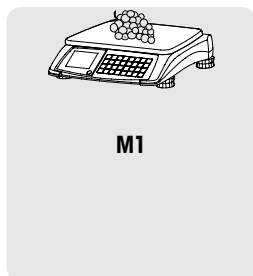

## PLU preset keys with two PLUs (factory setting, operator setup Step 14 = ON)

### Storing two PLUs to a preset key

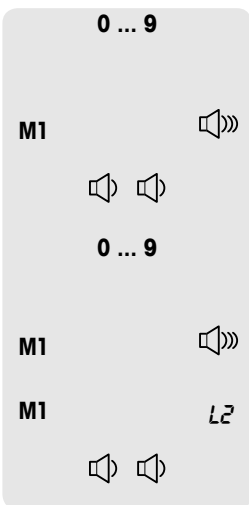

1. Enter the unit price or recall PLU of the **first** PLU to be assigned to the preset key.
2. Press and hold the desired preset key, e.g., **M1**, until a long beep can be heard.  
Two short beeps indicate that the data has been stored.
3. Enter the unit price or recall PLU of the **second** PLU to be assigned to the preset key.
4. Press and hold the desired preset key, e.g., **M1**, until a long beep can be heard.
5. Immediately press the desired preset key again, e.g., **M1**.  
L2 is displayed and two short beeps indicate that the data has been stored.



**M1**

**M1 M1**

### Calling up PLUs with preset keys

1. Place the item on the scale.
2. To call up the **first** PLU, press the corresponding preset key once, e.g., **M1**.  
Unit price and price to pay of the first PLU are displayed.  
  
or  
  
To call up the **second** PLU, press the corresponding preset key twice, e.g., **M1, M1**.  
Unit price and price to pay of the second PLU are displayed.
3. Remove the item from the scale.  
All displays return to 0.



### 3.3

#### Using tare

You fill containers with your products or customers bring their own container. The tare function makes sure that only the goods are entered and paid.

If you know the weight of your containers, you can enter the tare weight via the keyboard. So you do not have to tare the empty container.

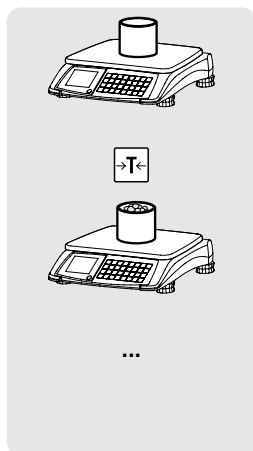

#### Taring an empty container

1. Place the empty container on the scale.
2. Press the **Tare** key.  
The weight display is reset to 0.000 and the NET symbol appears.  
The tare weight is displayed in the bottom line of the display.
3. Fill the container with the goods to be weighed.
4. Carry out pricing as described above.
5. Remove the container from the scale.  
All displays return to 0.

#### Keyboard tare

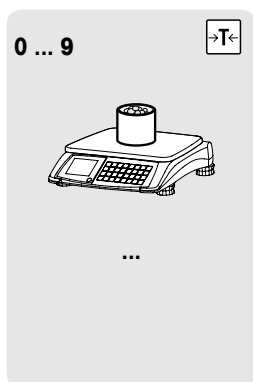

1. Input the known tare value and press the **Tare** key.  
The input tare value is displayed in the bottom line of the display and the PT cursor is lit.  
The weight display shows the negative tare value.
2. Place the item with container or wrapping material onto the scale.
3. Carry out pricing as described above.
4. Remove the item with container or wrapping material from the scale.  
All displays return to 0.

### 3.4

#### Zeroing

Due to soiling on the weighing pan or unfavourable external influences, it is possible that the weight display of an unloaded weighing pan may no longer be 0.000. In such cases, the scale must be reset to zero. The maximum allowed deviation to be compensated by zeroing is +/- 2 % of the weighing range.

0.0 10 kg



0.000 kg

- ▶ Press the **Zero** key.

The weight display is set to zero.

### 3.5

#### By-count operation

With the by-count function, you can price non-weighing items, e.g., in the bakery department.

0 ... 9



X

0 ... 9

1. Enter the unit price.
2. Press the **X** key to call up the by-count function.  
The by-count icon is displayed.
3. Enter the number of items (1 ... 99).  
The price to pay is displayed.



- The unit price is stored until by-count operation is ended.
- Use the **C** key to leave by-count operation.

### By-count operation (US version)

With the by-count function, you can price non-weighing items, e.g., in the bakery department. Pricing can base on a deal quantity of, e.g., 3 pieces.

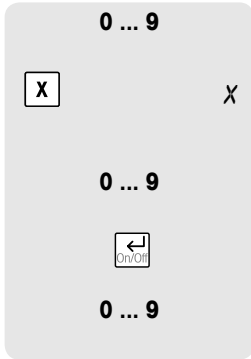

1. Enter the deal quantity (1 ... 99).
2. Press the **X** key to call up the by-count function. The by-count icon is displayed.
3. Enter the price per deal quantity.
4. Confirm with the **Enter** (On/Off) key.
5. Enter the number of items (1 ... 99). The price to pay is displayed.



- The unit price is stored until by-count operation is ended.
- Use the **C** key to leave by-count operation.

### 3.6

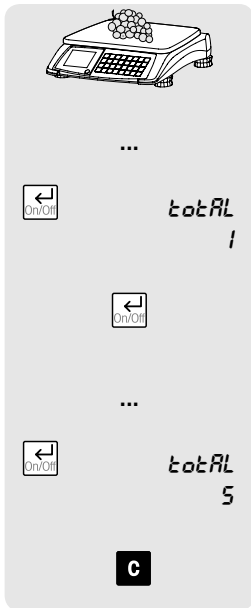

### Accumulating

This functionality is only legal in certain regions or, if admissible, if the weighing system is connected to an external printer.

1. Place the first item on the scale.
2. Enter the unit price.
3. Press the **Enter** (On/Off) key. The total price to pay and the number of items is displayed.
4. Remove the item and press the **Enter** (On/Off) key again. The weight display is shown.
5. Repeat steps 1 to 4 for more items.
6. To finish the transaction, press the **Enter** (On/Off) key. The total price to pay and the number of items is displayed.
7. To clear the total, press and hold the **C** key. The total is cleared.



If a printer is connected, a printout can be generated by pressing the **Enter** (On/Off) key twice. After printing, the total is cleared automatically.

**3.7****Change function**

Your scale is able to calculate the amount of change.

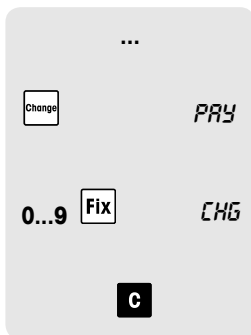
**Single item**

1. Carry out pricing as described in section 3.1.
2. Press the **Change** key.  
The total price to pay is displayed.
3. Enter the customer's payment and press the **FIX** key.  
The amount of change is displayed.
4. Press the **C** key to return to normal weighing mode.

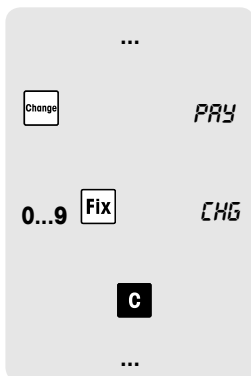
**Multiple items**

1. Carry out accumulating as described 3.6.
2. When the total is displayed press the **Change** key.  
The total price to pay is displayed.
3. Enter the customer's payment and press the **FIX** key.  
The amount of change is displayed.
4. Press the **C** key to finish the change function.
5. Clear total as described above.

### 3.8

#### Fix unit price and/or tare

In normal operation, unit price and tare weight – if applicable – are cleared when the item is removed from the scale.

For weighing and pricing, several samples of the same PLU, e.g., for prepacking or sweet sales, you can fix unit price and/or tare.

#### Fixing price and tare weight

1. Tare the container as described 3.1.

2. Place the first sample on the scale.

3. Carry out pricing as described above.

4. Press the **FIX** key.

When removing the item from the scale, the unit price and tare are still displayed.

5. Place the next sample on the scale.

The price to pay is displayed.

6. Remove the item from the scale.

7. Repeat steps 5 and 6 for more samples of the same unit price and tare.

8. Press the **FIX** key again to clear the unit price and tare.

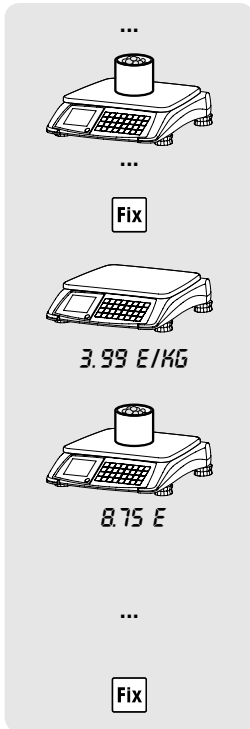

- To fix the price only, just begin with step 2.
- To fix the tare weight only, just leave out steps 2 and 3.

### 3.9

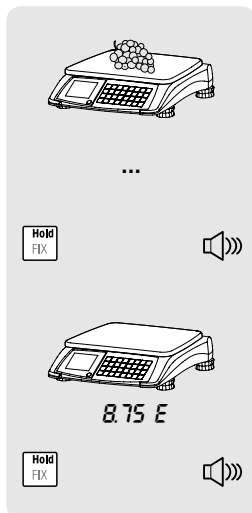

#### Hold function

When using the hold function, the price to pay is kept in the display when the item is removed from the scale.

1. Place the item on the scale.
2. Carry out pricing as described in section 3.1.
3. Press and hold the **Hold** (FIX) key until a long beep can be heard. Weight and unit price are cleared, the price to pay and "Hold" are displayed.
4. When removing the item from the scale, the price to pay is still displayed.
5. To return to normal weighing mode, press and hold the **Hold** key again until a long beep can be heard.

### 3.10

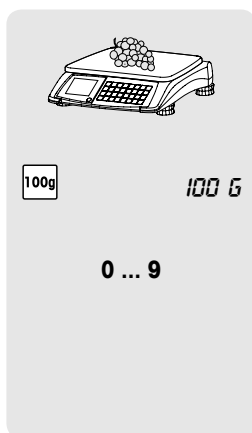

#### Weighing with 100 g (1/2 lb / 1/4 lb) price unit

For many products, customers are used to a price per 100 g (1/2 lb / 1/4 lb).

This function is only available if permitted by the national W & M regulations.

1. Place the item on the scale.
2. Press the **100 g** (1/2 lb / 1/4 lb) key. The icon 100 g (1/2 lb / 1/4 lb) is displayed.
3. Enter the unit price per 100 g (1/2 lb / 1/4 lb). The unit price per 100 g (1/2 lb / 1/4 lb) and the price to pay are displayed.
4. Remove the item from the scale. All displays return to 0.



100 g (1/2 lb / 1/4 lb) mode stays active until the **100 g** (1/2 lb / 1/4 lb) key is pressed again.

### 3.11 Switching weighing unit between kg and lb

This function is only available if permitted by the national W & M regulations.

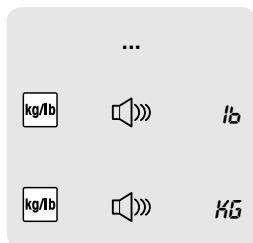

1. Carry out pricing as described above.
2. Press the **Units** key until a long beep can be heard. The weight is displayed in the second weight unit.
3. Press the **Units** key again until a long beep can be heard to return to the first weight unit.

### 3.12 Displaying the price to pay in EURO

Depending on the setting of operator setup Step 10, the price to pay can be converted, e.g., from EURO to the old local currency. This function is only available if permitted by the national W & M regulations.

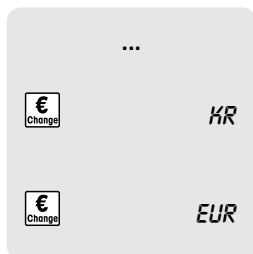

1. Carry out pricing as described above.
2. Press the **EUR** key. The price to pay is displayed in the second currency.
3. Press the **EUR** key again to return to the first currency.

### 3.13 Backlight function

If the light of the environment is not bright enough to get a clear reading from the display, the backlight can be switched on.

#### Switching backlight on/off



- ▶ Press and hold the **C** key until a long beep can be heard. The backlight is switched on/off.



When the scale is not used for 15 seconds, the backlight automatically switches off. When a weight is placed on the scale or when a key is pressed, the backlight switches on again.

### 3.14

### Ticket printing



- Ticket printing is not available in all countries.
- For ticket printing, operator setup Step 16 must be set to "1".

#### 3.14.1

#### Ticket without VAT

For ticket printing without VAT, operator setup Step 21 must be set to "OFF".

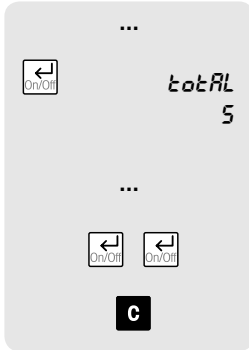

1. Carry out accumulating as described in section 3.6.
2. To finish the transaction, press the **Enter** (On/Off) key.  
The total price to pay and the number of items are displayed.
3. If desired, enter the amount of change as described above.
4. To initiate printing, press the **Enter** (On/Off) key twice.
5. Press the **C** key to cancel the transaction.

#### Printout example

TickNr 25		
2010-10-10 10:10		
-----		
PLU TEXT		
kg (pcs)	€/kg(pcs)	€
-----		
PLU 5		
0.110	45.67	5.02
Preset 1		
1.165	4.56	5.31
Non PLU		
5	0.95	4.75
-----		
Total	15.08	
Cash	20.00	
-----		
Change	4.92	



### 3.14.2 Ticket with VAT

For ticket printing with VAT, operator setup Step 21 must be set to "ON" (factory setting).

#### Storing VAT on a key

To store a VAT on the keys **M9** to **M1**, operator setup Step 22 must be set to "1".

**M9 ... M12**

**0 ... 9**



1. Press and hold one of the keys **M9** to **M12** until a long beep can be heard.
2. Enter VAT rate and confirm with the **Enter** (On/Off) key. E.g., enter 7.00 for VAT rate 7%.

#### Printing a ticket with VAT

1. Carry out pricing as described in section 3.1.
2. Press the corresponding VAT key (**M9** to **M12**).
3. Repeat steps 1 and 2 for further items.
4. To finish the transaction, press the **Enter** (On/Off) key. The total price to pay and the number of items are displayed.
5. If desired, enter the amount of change as described above.
6. To initiate printing, press the **Enter** (On/Off) key twice.
7. Press the **C** key to cancel the transaction.

...

**M9 ... M12**

...



*total*  
5

...



**C**

### Printout example

TickNr 25		
2010-10-10 10:10		
-----		
PLU TEXT		
kg (pcs)	€/kg(pcs)	€
-----		
PLU 5		
0.110	45.67	5.02
Preset 1		
1.165	4.56	5.31
Non PLU		
5	0.95	4.75
-----		
Total	15.08	
Tax	7.00 %	0.72
Tax	19.00 %	0.85
-----		
Cash	20,00	
-----		
Change	4.92	

## 3.15

### Printing reports

### 3.15.1

#### Printing sales report

**M5** 

- ▶ Press the report button **M5** and confirm with the **Enter** (On/Off) key.

The sales report is printed.

When printing is finished you are asked if you want to delete the sales report.

*DELETE*

### Sales report example

Sale Report		
Report number 25		
Start time	2010-10-10	20:53
To time	2010-10-16	21:02
Item	kg/pcs/time	€
By Weight	35.378	323.79
By Count	145	691.56
PLU Sales		923.44
Non PLU		191.91
Sales Total		1115.35
Tax		127.89

### 3.15.2 Printing Log report

M5 M5 

DELETE

1. Press the report button **M5** twice and confirm with the **Enter** (On/Off) key.
2. Select the range of transactions to be printed.

The log report is printed.

When printing is finished you are asked if you want to delete the transactions.

#### Log report example

Sale Log		
Ticket number 25		
2010-10-10 10:10		
Item	kg/pcs/time	€
PLU 5	0.110	5.02
Preset 1	1.165	5.31
Non PLU	5	4.75
-----		
Sale Log		
Ticket number 26		
2010-10-10 10:13		
Item	kg/pcs/time	€
PLU 3	0.155	15.02
Non PLU	3	2.97
Preset 2	1.855	7.39
-----		
...		

## 4 Operator setup

### 4.1 Setup operation

#### 4.1.1 Entering operator setup

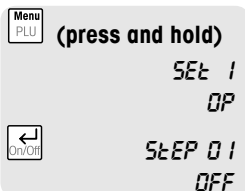

1. Press and hold the **Menu** (PLU) key until a long beep can be heard. SET 1 OP is displayed for "Operator Setup"
2. Press the **Enter** (On/Off) key to enter operator configuration. The first operator setup step and its current setting are displayed.

#### 4.1.2 Navigation in the setup

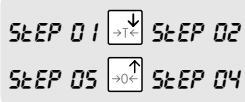

#### Selecting setup step

- ▶ To move to another setup step, use the **Arrow down** (Tare) key or **Arrow up** (Zero) key. In the line below, the current setting of the step is displayed.

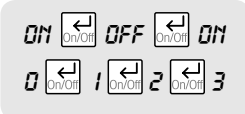

#### Changing settings

- ▶ To toggle between the settings of a setup step, use the **Enter** (On/Off) key. When moving to another setup step, the selected setting is confirmed.

#### 4.1.3 Ending setup



1. Press the **Menu** (PLU) key to leave operator setup steps.
2. Press the **Menu** (PLU) key again to leave the setup mode. SAVE is displayed.
3. If you do not want to save, use the **Enter** (On/Off) key to toggle between SAVE and ABORT.
4. Press the **Menu** (PLU) key a third time to return to the weighing mode.

#### 4.1.4

#### Example: Setting digital filter to low (operator setup Step 8 = 0)

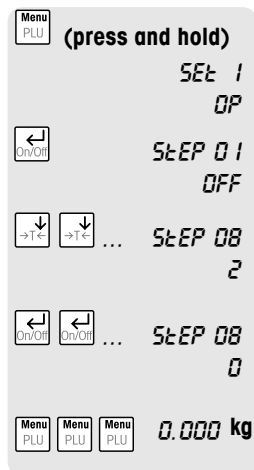

1. Press and hold the **Menu (PLU)** key until a long beep can be heard. SET 1 OP is displayed for "Operator Setup".
2. Press the **Enter (On/Off)** key to enter operator configuration. The first operator setup step and its current setting are displayed.
3. To move to setup Step 8, press the **Arrow down (Tare)** key repeatedly until Step 08 with its current setting is displayed.
4. To change the setting of setup Step 8, press the **Enter (On/Off)** key repeatedly until the setting is 0.
5. End setup by pressing the **Menu (PLU)** key three times.

#### 4.2

#### Operator setup overview

Factory settings are indicated in **bold** print.

#### No. Setting Description

##### 1 Reset

- ON Reset operator setup functions to factory settings  
**OFF** Do not reset operator setup functions

##### 2 Beeper

- ON** Beep when a key is pressed  
 OFF No sound when a key is pressed

##### 3 Backlighting

- ON Backlighting on  
**OFF** Backlighting off

##### 4 Power off / sleep

- 0 Both disabled, power off and sleep function  
 1 No sleep funktion,  
 automatic power off after 30 minutes of non-use  
 2 Sleep funktion after 5 minutes of non-use,  
 no automatic power off  
 3 Sleep funktion after 5 minutes of non-use,  
 automatic power off after 30 minutes of non-use  
 4 Sleep funktion after 15 minutes of non-use,  
 no automatic power off  
**5** Sleep funktion after 15 minutes of non-use,  
 automatic power off after 30 minutes of non-use

No.	Setting	Description
<b>5</b>	<b>Auto clear tare</b>	
	<b>ON</b>	Automatic clearing of the tare weight when the load is removed from the platform
	<b>OFF</b>	No automatic clearing of the tare weight
<b>6</b>	<b>Prepack / fix mode</b>	
	<b>ON</b>	Prepack / fix mode enabled
	<b>OFF</b>	Prepack / fix mode disabled
<b>7</b>	<b>Auto PLU</b>	
	<b>ON</b>	Find PLU as soon as a number is entered
	<b>OFF</b>	Find PLU after pressing the PLU key
<b>8</b>	<b>Digital filter</b>	
	<b>0</b>	Low digital filtering
	<b>1</b>	Medium digital filtering
	<b>2</b>	High digital filtering
<b>9</b>	<b>Charging function</b>	
	<b>ON</b>	Battery charging function enabled
	<b>OFF</b>	Battery charging function disabled To change charging function you are asked to enter a password: 55555
<b>10</b>	<b>Function keys</b>	
	<b>0</b>	Function keys disabled
	<b>1</b>	Function keys enabled
<b>11</b>	<b>PLU</b>	
	<b>ON</b>	Storing PLUs enabled
	<b>OFF</b>	Storing PLUs disabled
<b>12</b>	<b>By-count operation</b>	
	<b>ON</b>	By-count operation enabled
	<b>OFF</b>	By-count operation disabled
<b>13</b>	<b>Euro</b>	
	<b>1</b>	Only the local currency is displayed
	<b>2</b>	You are asked to enter the conversion rate from the local currency into EUR. When pressing the EUR key, the local currency is converted into EUR.
	<b>3</b>	You are asked to enter the conversion rate from EUR into the local currency. When pressing the EUR key, EUR is converted into the local currency.
	<b>4</b>	Only EUR is displayed.

---

**No. Setting Description****14 Two PLUs in one preset key**

- ON** Two PLUs can be preset in one preset key  
**OFF** Only one PLU can be preset in a preset key
- 

**15 Communication port**

- 0** RS232  
**1** USB
- 

**16 Communication type**

- 0** Protocol transfer to a connected computer  
**1** Printout on a connected printer (not available in all countries)
- 

**17 Ticket language (not available in all countries)**

- 0** English  
**1** French  
**2** German  
**3** Spanish  
**4** Italian
- 

**18 RS232 communication speed**

- 0** 1200 bps  
**1** 2400 bps  
**2** 4800 bps  
**3** 9600 bps  
**4** 19200 bps  
**5** 38400 bps  
**6** 57600 bps
- 

**19 Communication format**

- 0** 7 data bits, parity even, 1 stop bit  
**1** 7 data bits, parity odd, 1 stop bit  
**2** 7 data bits, no parity, 1 stop bit  
**3** 8 data bits, no parity, 1 stop bit  
**4** 7 data bits, parity even, 2 stop bits  
**5** 7 data bits, parity odd, 2 stop bits  
**6** 7 data bits, no parity, 2 stop bits  
**7** 8 data bits, no parity, 2 stop bits
-

No.	Setting	Description
<b>20</b>	<b>Price computing protocol type</b>	
0	CAS	
1	Avery Berkel	
<b>2</b>	Dialog 06	
3	L2 Mettler Toledo	
4	Anker	
5	Dialog 02/04	
6	NCI Protocol	
<b>21</b>	<b>VAT (not available in all countries)</b>	
<b>ON</b>	Price is with VAT	
<b>OFF</b>	Price is without VAT	
<b>22</b>	<b>VAT key (not available in all countries)</b>	
<b>0</b>	VAT key disabled	
<b>1</b>	VAT key enabled	
<b>23</b>	<b>PLU tare</b>	
<b>ON</b>	Storing unit price and tare weight in the PLU	
<b>OFF</b>	Storing unit price only in the PLU	

### 4.3

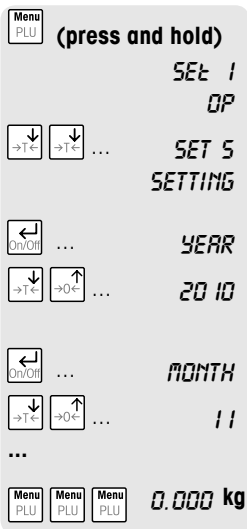

### Setting date and time

1. Press and hold the **Menu** (PLU) key until a long beep can be heard.
2. Press the **Arrow down** (Tare) key repeatedly until SET 05 SETTING is displayed.
3. Press the **Enter** (On/Off) key to set the year.
4. Use the **Arrow down** (Tare) key or **Arrow up** (Zero) key to change the year.
5. Repeat steps 3 and 4 to set month, day, hour, minute and second.
6. End setup by pressing the **Menu** (PLU) key three times.



# 5 What do you do if....?

## General

If the scale shows an error message, proceed as follows:

1. Turn off the scale and wait for approx. 5 seconds.
2. Turn on the scale.
3. If the error message is still displayed, refer to the error message list.

## Error message list

<b>Error</b>	<b>Cause</b>	<b>Remedy</b>
E11	RAM error	▶ Call service technician
E16	ROM error	▶ Call service technician
E18	EEPROM error	▶ Call service technician
E34	PLU No. too high	▶ Enter PLU No. from 1 to 99
No PLU	PLU not found	▶ Store PLU
nnnnnn	Overload	▶ Reduce load
uuuuuu	Load too small	▶ Re-zero the scale

## 6 Technical data and accessories

### 6.1 Technical data

#### Display

Weight display	6 digits
Unit price display	6 digits
Total price display	7 digits

#### Ambient conditions

Operating temperature	-10 °C to +40 °C / 14 °F to 104 °F
Storage temperature	-25 °C to +50 °C / -13 °F to 122 °F
Relative humidity	Max. 80 % for up to 31 °C / 88 °F, decreasing linearly to 50 % at 40 °C / 104 °F
Altitude	up to 2000 m
General usage	Indoor use only

#### Electrical data

Power supply	12 V DC
Power consumption	50 mA
Plug-in adapter	Input: 100-240 V~ / 50-60 Hz Output: 12 V $\equiv$ / 0.8 A
Battery type	6 Alkaline or 6 NiMH D-cells
Charging current	500 mA
NiMH battery capacity	7000 mAh recommended

#### Interface

1 connector on the under-side	RS232C or USB, depending on the interface cable
-------------------------------	---

## 6.2

### Accessories

The following optional accessories are available from your sales representative:

- Plug-in adapter
- Weighing platform cover
- Scale cover
- POS connector RS232
- POS connector USB
- External printer
- Deep bowl
- Rechargeable NiMH batteries
- Printer cable



The offering of accessories may vary by the region.

## 6.3

### Compliance

Compliance to the following standards is indicated by the corresponding mark on the product.



This product conforms to the EMC directive 2004/108/EC, the Low Voltage Directive 2006/95/EC and the Non-automatic Weighing Instruments Directive 2009/23/EC. The complete Declaration of Conformity is available online at

<http://europe.ohaus.com/europe/en/home/support/compliance/declaration-of-conformity.aspx>.



CAN/CSA C22.2 No. 61010-1-07, UL Std No. 61010-1 (2nd edition)

6.4

**Important notice for verified weighing instruments used in Europe**



Weighing instruments verified at the place of manufacture bear one of the preceding marks on the packing label and the green "M" (metrology) sticker on the descriptive plate. They may be put into service immediately.



Weighing instruments to be verified in two stages have no green "M" (metrology) sticker on the descriptive plate and bear one of the preceding identification marks on the packing label. The second stage of the initial verification must be carried out by the approved service organization of the authorized representative within the EC or by the national weights & measures (W+M) authorities.

The first stage of the initial verification has been carried out at the manufacturer's work. It comprises all tests according to the adopted European standard EN 45501:1992, paragraph 8.2.2

If national regulations limit the validity period of the verification, the user of the weighing instrument must strictly observe the re-verification period and inform the respective W+M authorities.

6.5

**Legal for Trade**

When the scale is used in trade or a legally controlled application, it must be set up, verified and sealed in accordance with local weights and measures regulations. It is the responsibility of the purchaser to ensure that all pertinent legal requirements are met. As verification requirements vary by jurisdiction, the purchaser should contact their local weights and measures office if they are not familiar with the requirements.

For products sold in Europe, the verification process has been completed at the place of manufacture. These products will already be sealed and will bear the green "M" (metrology) sticker on the descriptive plate. They may be put into service immediately.

For products sold in other regions, the verification process must be performed at the place of use.

To prevent access to calibration and metrological settings, the scale must be sealed using a paper seal or wire seal as shown below.

**Paper seal    Wire seal**

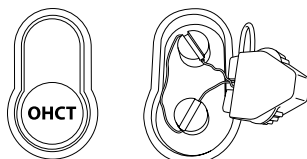

# 7

## Annexe



### Disposal in Europe

In conformance with the European Directive 2002/96 EC on Waste Electrical and Electronic Equipment (WEEE), this device may not be disposed of in domestic waste. This also applies to countries outside the EU, per their specific requirements.

The Batteries Directive 2006/66/EC introduces new requirements from September 2008 on removability of batteries from waste equipment in EU Member States. To comply with this Directive, this device has been designed for safe removal of the batteries at end-of-life by a waste treatment facility.

- ▶ Please dispose of this product in accordance with local regulations at the collecting point specified for electrical and electronic equipment.

If you have any questions, please contact the responsible authority or the distributor from which you purchased this device.

Should this device be passed on to other parties (for private or professional use), the content of this regulation must also be related.

For disposal instructions in Europe, refer to  
<http://europe.ohaus.com/europe/en/home/support/weee.aspx>.

Thank you for your contribution to environmental protection.

### 7.2

#### FCC Note

This equipment has been tested and found to comply with the limits for a Class A digital device, pursuant to Part 15 of the FCC Rules. These limits are designed to provide reasonable protection against harmful interference when the equipment is operated in a commercial environment. This equipment generates, uses, and can radiate radio frequency energy and, if not installed and used in accordance with the instruction manual, may cause harmful interference to radio communications. Operation of this equipment in a residential area is likely to cause harmful interference in which case the user will be required to correct the interference at his own expense.

### 7.3

#### **ISO 9001 Registration**

In 1994, Ohaus Corporation, USA, was awarded a certificate of registration to ISO 9001 by Bureau Veritus Quality International (BVQI), confirming that the Ohaus quality management system is compliant with the ISO 9001 standard's requirements. On May 21, 2009, Ohaus Corporation, USA; was re-registered to the ISO 9001:2009 standard.





Subject to technical changes  
© 2013 Ohaus Corporation  
Printed in Switzerland  
Order number 72246392C  
[www.ohaus.com](http://www.ohaus.com)