

Android 10 Rugged Tablet

- TB85 Plus-



User's Manual

Version 1.1



Revision History

Date	Change Description	Version
2021/8/31	first published version	1.0
2022/1/10	Update ch.2 (Add 2.12)	1.1

Preface

About This Manual

Thank you for purchasing the unitech product.

This manual explains how to install, operate and maintain our product.

No part of this publication may be reproduced or used in any form, or by any electrical or mechanical means, such as photocopying, recording, or information storage and retrieval systems, without permission in writing from the manufacturer. The material in this manual is subject to change without notice.

Regulatory Compliance Statements



FCC Warning Statement

This device has been tested and found to comply with the limits for a Class B digital device, pursuant to part 15 of the FCC rules. These limits are designed to provide reasonable protection against harmful interference in a residential installation. This equipment generates, uses and can radiate radio frequency energy and, if not installed and used in accordance with the instructions, may cause harmful interference with radio communications. However, there is no guarantee that interference will not occur in a particular installation. If this equipment does cause harmful interference with radio or television reception, which can be determined by turning the equipment off and on, the user is encouraged to try to correct the interference by one or more of the following measures:

- Reorient or relocate the receiving antenna.
 - Increase the separation between the equipment and receiver.
 - Connect the equipment into an outlet on a circuit different from that to which the receiver is connected.
 - Consult the dealer or an experienced radio/TV technician for help.
1. This transmitter must not be co-located or operating in conjunction with any other antenna or transmitter.
 2. This device complies with FCC RF radiation exposure limits set forth for an uncontrolled environment. To maintain compliance with FCC RF exposure requirements, avoid direct contact to the transmitting antenna during transmitting.
 3. Any changes or modifications (including the antennas) made to this device that are not expressly approved by the manufacturer may void the user's authority to operate the equipment.

FCC Label Statement

This device complies with part 15 of the FCC rules. Operation is subject to the following two conditions:

1. This device may not cause harmful interference.
2. This device must accept any interference received, including interference that may cause undesired operation.

RF Radiation Exposure Statement

For body contact during operation, this device has been tested and meets FCC RF exposure guidelines when used with an accessory that contains no metal and that positions the handset a minimum of 1.0 cm from the body. Use of other accessories may not ensure compliance with FCC RF exposure guidelines.

European Conformity Statement

unitech Electronics co., Ltd herewith declares that the unitech product is in compliance with the essential requirements and all other provisions of the RED 2014/53/EU directive.

The declaration of conformity is available for download at :
<https://portal.unitech.eu/public/Safetyregulatorystatement>

CE RF Exposure Compliance

For body-worn operation, this device has been tested and meets the ICNIRP guidelines and the European Standard EN 62209-2, for use with dedicated accessories, SAR is measured with this device at a separation of 0.5 cm to the body, while transmitting at the highest certified output power level in all frequency bands of this device. Use of other accessories which contain metals may not ensure compliance with ICNIRP exposure guidelines.

CE Mark Warning



RoHS Statement



This device conforms to RoHS (Restriction Of Hazardous Substances) European Union regulations that set maximum concentration limits on hazardous materials used in electrical and electronic equipment.

Waste electrical and electronic equipment (WEEE)

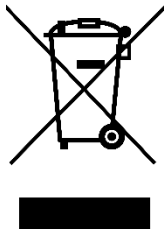

unitech has set up a policy and process to meet the 2012/19/EU concerning electronic waste disposal.

For more detailed information of the electronic waste disposal of the products you have purchased from unitech directly or via unitech's resellers, you shall either contact your local supplier or visit us at :

<https://portal.unitech.eu/public/WEEE>

Taiwan NCC Warning Statement

低功率電波輻射性電機管理辦法

第十二條：經型式認證合格之低功率射頻電機，非經許可，公司、商號或使用者均不得擅自變更頻率、加大功率或變更原設計之特性及功能。

第十四條：低功率射頻電機之使用不得影響飛航安全及干擾合法通信；經發現有干擾現象時，應立即停用，並改善至無干擾時方得繼續使用。

前項合法通信，指依電信法規定作業之無線電通信。

低功率射頻電機需忍受合法通信或工業、科學及醫療用電波輻射性電機設備之干擾。

SAR標準值2.0W/KG, 送測產品實測值為： (W/KG)

注意事項：

1. 使用過度恐傷害視力。
2. 使用30分鐘請休息10分鐘；2歲以下幼兒不看螢幕，2歲以上每天看螢幕不要超過1小時。
3. 減少電磁波影響，請妥適使用。
4. 因應各地區/國家開放頻道不同，請依據當地主管機關與電信業者實際公告資訊為主，如服務細則有所變更，請自行洽詢電信業者，恕不另通知。
5. 無線資訊傳輸設備避免影響附近雷達系統之操作

Note:

Within the 5.25-5.35 GHz band, U-NII devices will be restricted to indoor operations to reduce any potential for harmful interference to co-channel MSS operations.

Laser Information

The unitech product is certified in the U.S. to conform to the requirements of DHHS/CDRH 21CFR Subchapter J and to the requirements of IEC 60825-1. Class II and Class 2 products are not considered to be hazardous. The unitech product contains internally a Visible Laser Diode (VLD) whose emissions do not exceed the maximum limits as set forth in the above regulations. The scanner is designed so that there is no human access to harmful laser light during normal operation, user maintenance or prescribed service operations.

The laser safety warning label required by the DHHS/IEC for the unitech product's optional laser scanner module is located on the memory compartment cover, on the back of the unit.

* Laser information only applies to the products with laser components.

CAUTION! Use of controls or adjustments or performance of procedures other than those specified herein may result in hazardous laser light. Use of optical instruments with the scanner, including binoculars, microscopes, and magnifying glasses, with will increase eye damage. This does not include eyeglasses worn by the user.

LED Information

The unitech product contains LED indicator(s) or LED ring whose luminance is not harmful to human eyes during normal operation, user maintenance or prescribed service operations.

*LED information only applies to the products with LED components.

Battery Notice

1. To guarantee optimal performance, it is recommended that rechargeable batteries be replaced every year, or after 500 charging cycles are completed. It is normal for the battery to balloon or expand after one year or 500 cycles. Although it does not cause damage, it cannot be used again and must be disposed of according to the location's safe battery disposal procedures.
2. If a battery performance decreases more than 20%, the battery is at the end of its life cycle. Stop use and ensure the battery is disposed of properly.
3. The length of time that a battery lasts depends on the battery type and how the device is used. Conserve the battery life by doing the following:
 - Avoid fully uncharging the battery because this places additional strain on it. Several partial uncharges with frequent charges are better than a fully uncharged battery. Charging a partially charged battery does not cause harm to the unit.
 - Keep the battery cool. Avoid hot vehicles. For prolonged storage, keep the battery at a 40% charge level.
 - Do not leave the battery uncharged and unused for an extended period of time, the battery will wear out and the longevity of the battery will be at least half of one with frequent charges.
4. Protect battery life by not over or under charging the battery.
5. Please do not leave battery unused for long time without charging it. Despite unitech's safety precautions, the battery pack may begin to change shape. If so, stop using it immediately. Please check to see if you are using a proper power adapter to charge the battery or contact your service provider for service.
6. If you cannot charge the battery after it has been idle for an extended period of time and it begins to heat up, please do not try to charge it. It may not be functional anymore.
7. Please only use the original battery from unitech. Using a third party battery can damage our products. Please note that when such damage occurs, it is not covered by unitech's warranty policy.

CAUTION!

- RISK OF EXPLOSION IF BATTERY IS REPLACED INCORRECTLY. DISPOSE OF USED BATTERIES ACCORDING TO THE INSTRUCTIONS.
- 如果更換不正確之電池行事會有爆炸的風險請依製造商說明書處理用過之電池
- 如果更換不正確之電池行事會有爆炸的風險請依製造商說明書處理用過之電池

Battery charge notice

It is important to consider temperature when the battery pack is charging. Charging is most efficient at normal room temperature or in a slightly cooler environment. It is essential that batteries are charged within the stated range of 0°C to 40°C. Charging batteries outside of the specified range could damage the batteries and shorten their life cycle.

CAUTION! Do not charge batteries at a temperature lower than 0°C. This will make the batteries unstable and dangerous. Please use a battery temperature detecting device for a charger to ensure a safe charging temperature range.

CAUTION! To ensure the unit working properly, please keep all connectors away from the contaminants staying inside of them such as dust, grease, mud, and water. The negligence may cause the unit with no communication, short circuited, overheated and so on.

CAUTION! If the connector is damaged, please ensure the connector is being fully repaired before use the unit to avoid causing short circuited.

Storage and safety notice

Although charged batteries may be left unused for several months, their capacity may be depleted due to build up of internal resistance. If this happens, they will require recharging prior to use. Batteries may be stored at temperatures between -20°C to 60°C, however they may deplete more rapidly at higher temperatures. It is recommended to store batteries at room temperature.

** The message above only applies to the usage of the removable batteries. For the products with non-removable batteries / without batteries, please refer to the specification of each product.*

Product Operation and Storage Notice

The unitech product has applicable operation and storage temperature conditions. Please follow the limitation of suggested temperature conditions to avoid failure, damage or malfunction.

**For applicable temperature conditions, please refer to the specification of each product.*

Adapter Notice

1. Please do not leave the power adapter in the socket when it is not connected to your unitech product for charging.
2. Please remove the power adapter when the battery is fully recharged.
3. The bundled power adapter that comes with your unitech product is not meant to be used outdoors. An adapter exposed to water or rain, or a very humid environment can cause damage to both the adapter and the product.
4. Please only use the bundled power adapter or same specification of adapter to charge your unitech product. Using the wrong power adapter can damage your unitech product.

** The message above only applies to the product connected to the adapter. For the products without using the adapters, please refer to the specification of each product.*

Hearing Damage Warning

To prevent possible hearing damage, do not listen at high volume levels for long periods.



Figure 1 – Warning label (IEC 60417-6044)

Worldwide Support

unitech's professional support team is available to quickly answer questions or assist with technical-related issues. Should an equipment problem occur, please contact the nearest unitech regional service representative.

For complete contact information please visit the Web sites listed below:

Taipei, Taiwan – Headquarters	Europe
Tel: +886-2-89121122 E-mail: info@hq.ute.com Address: 5F, No. 136, Lane 235, Baoqiao Road, Xindian District, New Taipei City 231, Taiwan (R.O.C.) Website: http://www.ute.com	Tel: +31-13-4609292 E-mail: info@eu.ute.com Address: Kapitein Hatterasstraat 19, 5015 BB, Tilburg, the Netherlands Website: http://eu.ute.com
China	Japan
Tel: +86-59-2310-9966 E-mail: info@cn.ute.com Address: Room401C, 4F, RIHUA International Mansion, Xinfeng 3rd Road, Huoju Hi-tech District, Xiamen, Fujan , China Website: http://cn.ute.com	Tel: +81-3-35232766 E-mail: info@jp.ute.com Address: Kayabacho Nagaoka Building 8F.,1-5-19 Shinkawa, Chuo-Ku, Tokyo, 104-0033, Japan Website: http://jp.ute.com
Asia & Pacific / Middle East	Latin America
Tel: +886-2-27911556 E-mail: info@apac.ute.com info@india.ute.com info@mideast.ute.com Address: 4F., No. 236, ShinHu 2nd Rd., NeiHu Chiu, 114, Taipei,Taiwan Website: http://apac.ute.com / http://mideast.ute.com	Tel: +52-55-5171-0528 E-mail: info@latin.ute.com Address: 17171 Park Row, Suite 210 Houston, TX 77084USA (Rep.) Website: http://latin.ute.com
North America	Please scan QR Code to visit us :
Tel: +1-714-8916400 E-mail: info@us.ute.com / info@can.ute.com Address: 6182 Katella Ave, Cypress, CA 90630, USA Website: http://us.ute.com	

Warranty Policy

The following items covered under the unitech Limited Warranty are free from defects during normal use:

The warranty period is varied from each country. Please consult with your supplier or unitech local office for actual length of warranty period to your purchased product.

Warranty becomes void if equipment is modified, improperly installed or used, damaged by accident or neglect, or if any parts are improperly installed or replaced by the user.

Table of Contents

Preface	i
About This Manual	i
Regulatory Compliance Statements	i
Laser Information	vi
LED Information	vi
Battery Notice.....	vii
Adapter Notice.....	ix
Hearing Damage Warning	x
Worldwide Support	xii
Warranty Policy	xiii
Chapter 1 - Overview	1
1.1 Package	1
1.2 Product Detail.....	2
1.3 Specifications	5
1.4 Getting Started	8
Chapter 2 – Installation & Operation	15
2.1 TB85 Plus 2D module Assembly	15
2.2 HF Setting	16
2.3 WWAN Setting.....	18
2.4 WLAN Setting.....	20
2.5 PAN Setting	22
2.6 GPS Setting.....	24
2.7 PC Setting	25
2.8 Camera Settings.....	28
2.9 Dark Theme and Night Light	33
2.10 Performing a Hardware Reset.....	37
2.11 Performing a Factory Data Reset	38

2.12 How to map the F1 & F2 Key	40
Chapter 3 – Introduction to Applications	42
3.1 Scan Service	42
3.2 StageGO	47
3.3 Software Update.....	50
3.4 MoboLink.....	52

Chapter 1 - Overview

1.1 Package

Please make sure the following contents are in the TB85 Plus gift box.
If something is missing or damaged, please contact your unitech representative.

The package contents

- TB85 Plus Android rugged tablet
- Battery
- Adapter (with plugs)
- Quick Start Guide
- USB Type-C Cable
- Regulatory Compliance Statements

1.2 Product Detail

Product View (Front View)

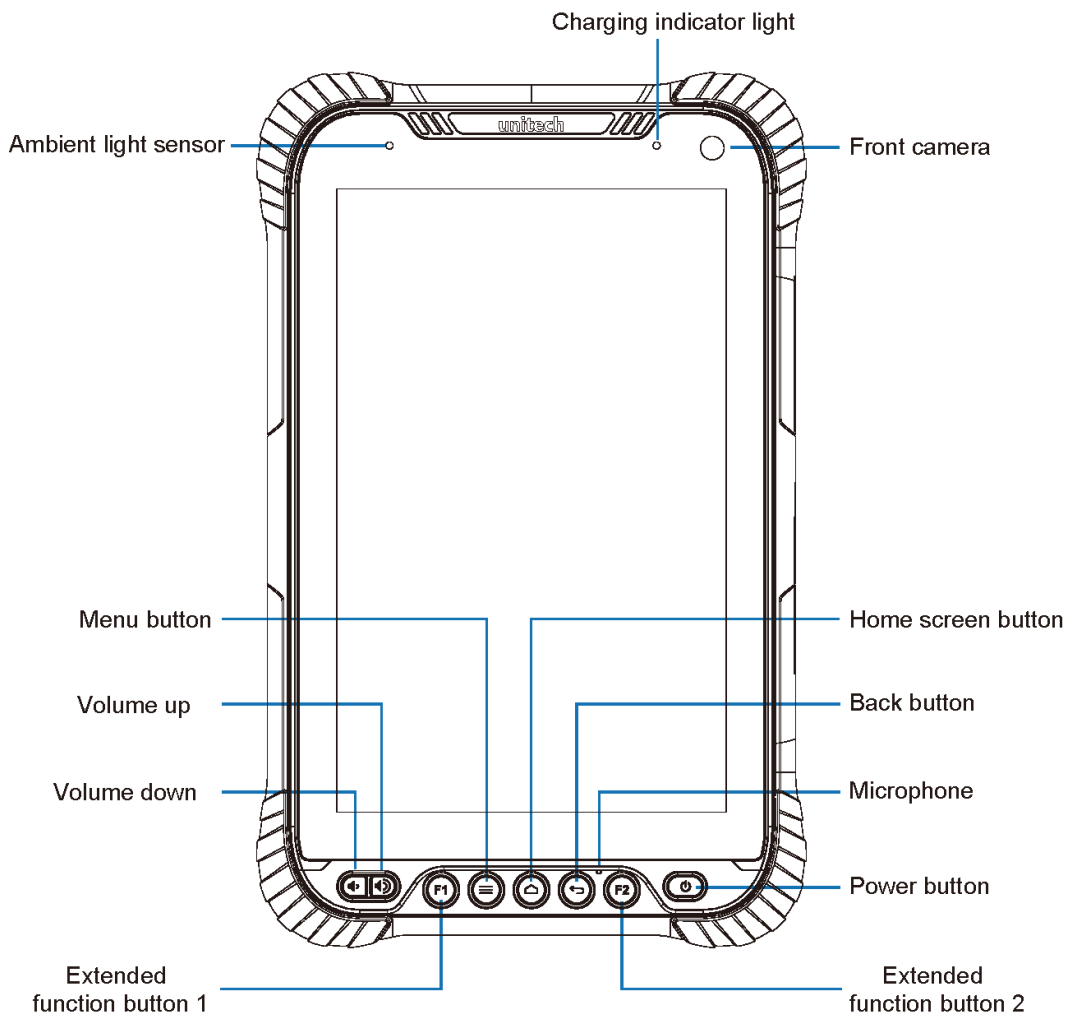

Product View (Rear View)

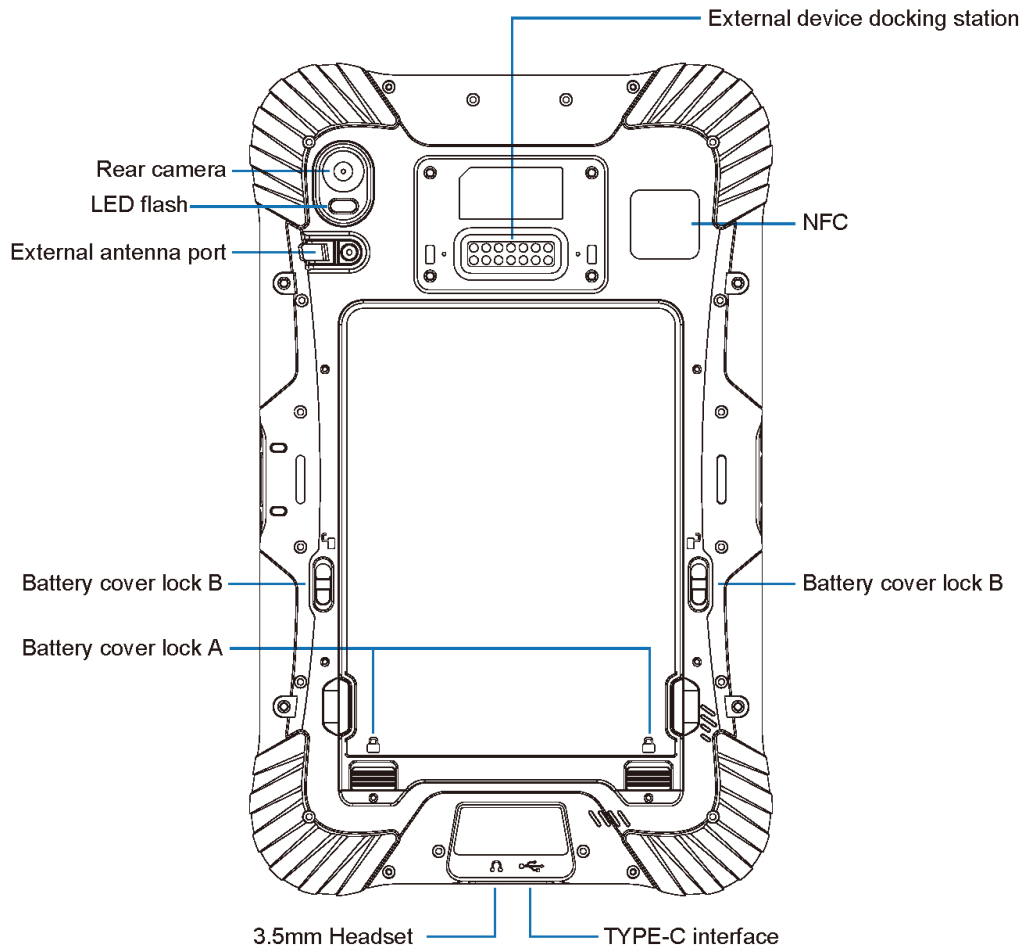

Product View (Side View)

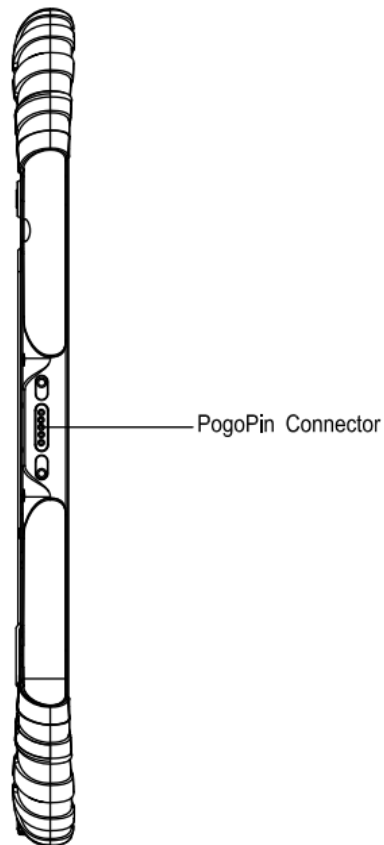

1.3 Specifications

Operating System	
CPU	2.2 Ghz, Qualcomm MSM8953 PRO Octa-Core
Memory	64GB RAM / 4GB Flash
OS	Android 10.0
GMS Certified	GMS Certified
Languages support	English, Thai, Simplified Chinese, Traditional Chinese, Japanese, Spanish, German, French Italian, Portuguese, Korean and multiple languages
Input Chinese/ English	Input Chinese/ English
Enclosure	
Dimensions	9.5 x 5.9 x 0.7 in (241.92 x 152 x 17.76mm)
Weight	1.3 lbs (630 grams) including battery
Display	
8" color (1280 x 800) LCD display 450nits Gorilla Glass III with capacitive touch panel. Support Capacitive Touch Screen.	
Keypad	
8 Function Keys: Power key, volume +/-, return key, home key, menu key and 2 customizable keys	
Indicator	
LEDs, Vibrator	
Camera	
5MP front camera 13M rear camera, AF with LED flash	
Symbologies	
2D Imager	2D / 1D barcode scan module with triggers
HF	Support HF/NFC Frequency 13.56Mhz Support: ISO14443A/B, ISO15693 standard

Regulatory approvals	
GMS, CE, RED, FCC, BSMI, NCC, RoHS	
Power Source	
Main Battery	8200 mAh Li-ION battery
I/O Interfaces	
USB	USB TYPE-C
POGO PIN	POGO pin
SIM Slot	Nano SIMx1
SIM Slot	Nano SIM x1
Expansion Slot	Micro SD x1
Audio	Microphone, speaker and 3.5mm audio jack
Communication	
WLAN	802.11 a/b/g/n/ac
WWAN	GSM: 850 / 900 / 1800 / 1900 TD-SCDMA: B34, 39 WCDMA: B1, 2, 5, 8 CDMA/EVDO: BC0 LTE-TDD: B38, 39, 40, 41 LTE-FDD: B1, 2, 3, 4, 5, 7, 8, 12, 13, 17, 20, 25, 28
GPS	GNSS-GLONASS (Global Navigation Satellite System)
Sensors	Ambient light sensor Hall sensor support for accessory Acceleration sensor Atmosphere pressure sensor
Environment	
Operating Temperature	-4° to 140° F (-20° to 60 °C)
Storage Temperature	-40° to 158° F (-40°C to 70 °C)
Relative Humidity	5% ~ 95% (Non-Condensing)
Drop Specification	1.2m
Sealing	IP67
Vibration/ Tumble test	MIL-STD-810G
Software	
Airwatch, SOTI	

Accessories

- Glass Screen Protector
- Power Adapter
- Rotatable Hand-Strap
- Shoulder Strap Case
- X-Hand Strap

Comes with the Google™ app and Google Chrome™

Android is a trademark of Google LLC.

Note:

The device is restricted to indoor use only when operating in the 5150 to 5350 MHz frequency range.

	AT	BE	BG	HR	CY	CZ	DK
	EE	FI	FR	DE	EL	HU	IE
	IT	LV	LT	LU	MT	NL	PL
	PT	RO	SK	SI	ES	SE	UK
	IS	LI	NO	CH	TR		

1.4 Getting Started

1.4.1 Peel off the screen protector

Before you peel off the screen protector, please note that there are two layers of the screen protector. Kindly pull on the white tab and remove the top layer of screen protector. Keep the second layer on the screen.

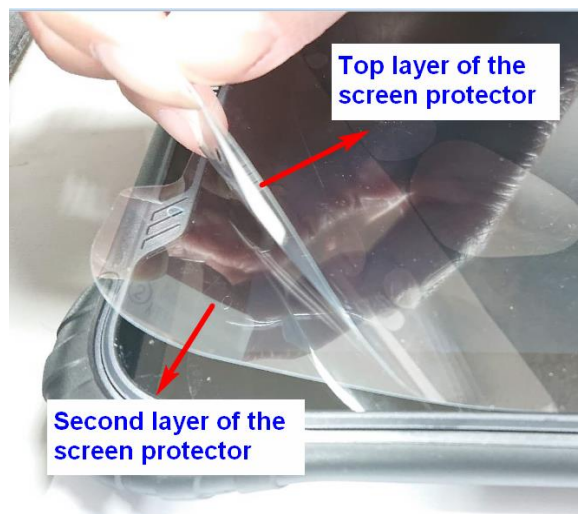

WARNING! Please DO NOT kink, shake or bend the cable. It may cause damage.

1.4.2 Turning the device on and off

Turn on the device: firmly press and hold the bottom right **【Power Button】** until the boot screen appears.

Turn off the device: firmly press and hold the **【Power Button】** to display the options menu. Select the **Power off** option to shut down.

Sleep mode: with the device turned on, press the **【Power Button】** to turn off the screen and go into sleep mode.

Wake and unlock the device: Press the **【Power Button】** to wake the device in the sleep mode, and swipe upwards to unlock the screen.

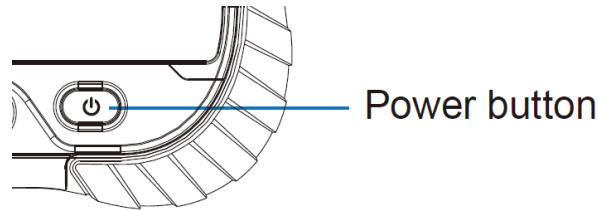

Note: If the device has been idle for a period of time, the screen will automatically go into sleep mode.

1.4.3 Insert Micro SD / Nano SIM card

1. Power off the device before inserting or removing the Micro SD card or the Nano SIM card.
2. Flip the device to its rear side.
3. Push the battery cover locks A and B upward to the open position (according to FIG. 1).
4. Detach the battery cover.
5. Insert the Micro SD card and SIM card according to the battery compartment (according to FIG. 2):
 - Face the Micro SD card metal contacts downwards and push into the slot.
 - Face the SIM card metal contacts downwards and push into the slot.

Note: When the battery is in, please remove the battery first following the instructions in the **1.4.5 Remove the Battery** before you insert or remove the Micro SD card or the Nano SIM card.

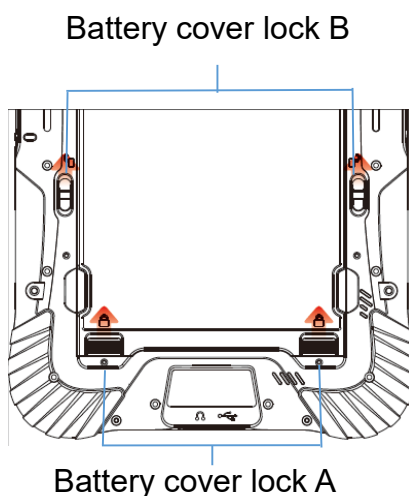

FIG. 1

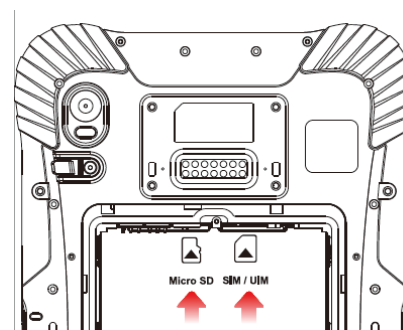

FIG. 2

1.4.4 Install the Battery

1. Flip the device to its rear side.
2. Push the battery cover locks A and B upward to the open position (according to FIG. 1).
3. Detach the battery cover.
4. Push the battery lock to the left (open position).
5. Insert the Battery: Align the contacts of the battery with the terminals of the battery compartment, and put in the battery gently. (①)
6. Push the battery lock to the right (close position). (②)
7. Attach the battery cover. (③)
8. Push the back cover locks A and B downward to the close position to secure the battery cover. (④)

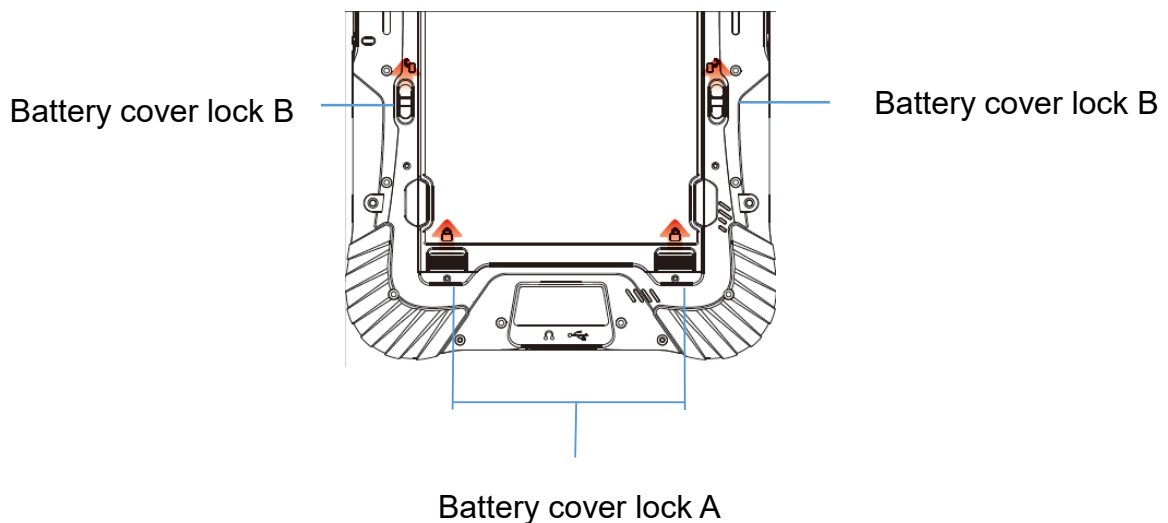
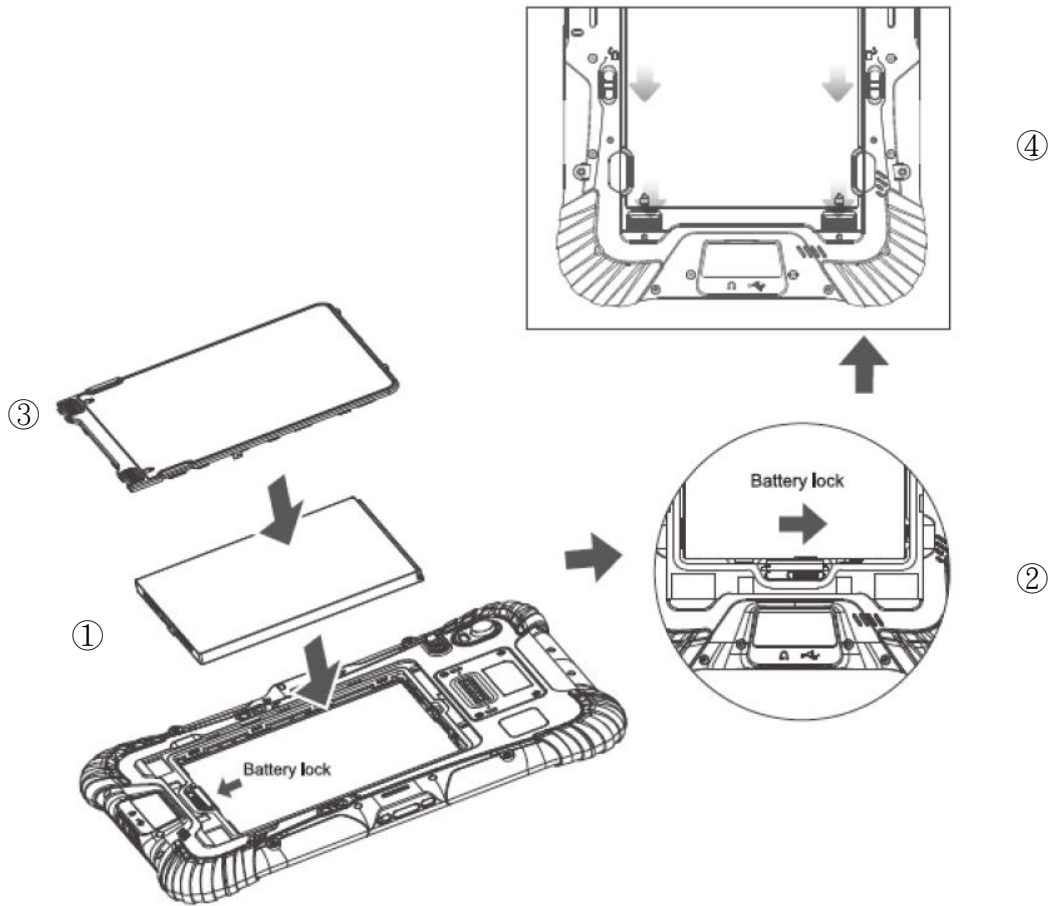

FIG. 1



WARNING! There is a risk of fire and burns if the battery is handled improperly. DO NOT disassemble, crush, puncture, short external contacts, or dispose the battery pack in fire or water. DO NOT attempt to open or service the battery. Dispose of used batteries according to local recycling guidelines in your area.

1.4.5 Remove the Battery

1. Power off the device before removing the battery.
2. Push the battery cover locks A and B upward to the open position (according to FIG. 1).
3. Detach the battery cover. (①)
4. Push the battery lock to the left (open position). (②)
5. Remove the battery. (③)

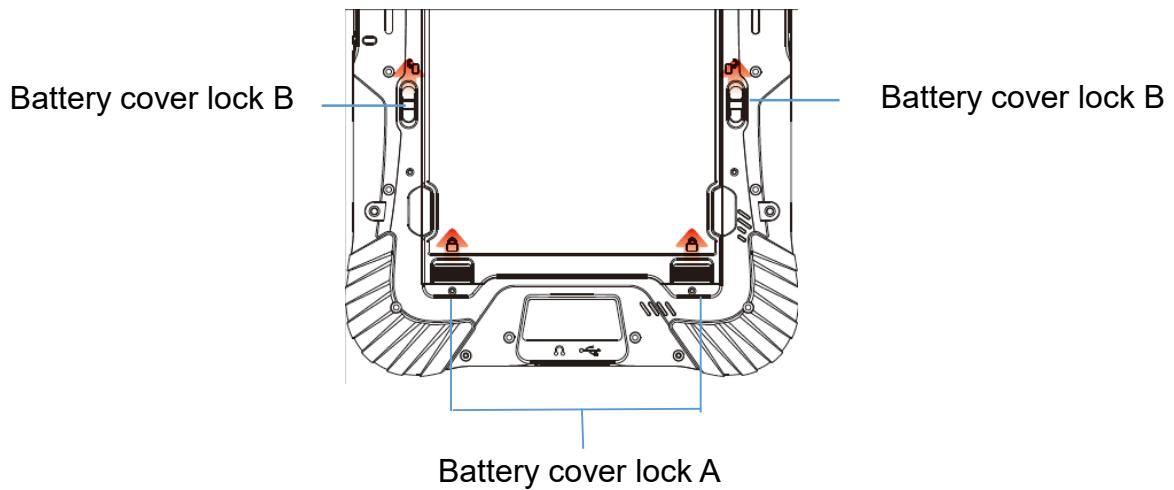
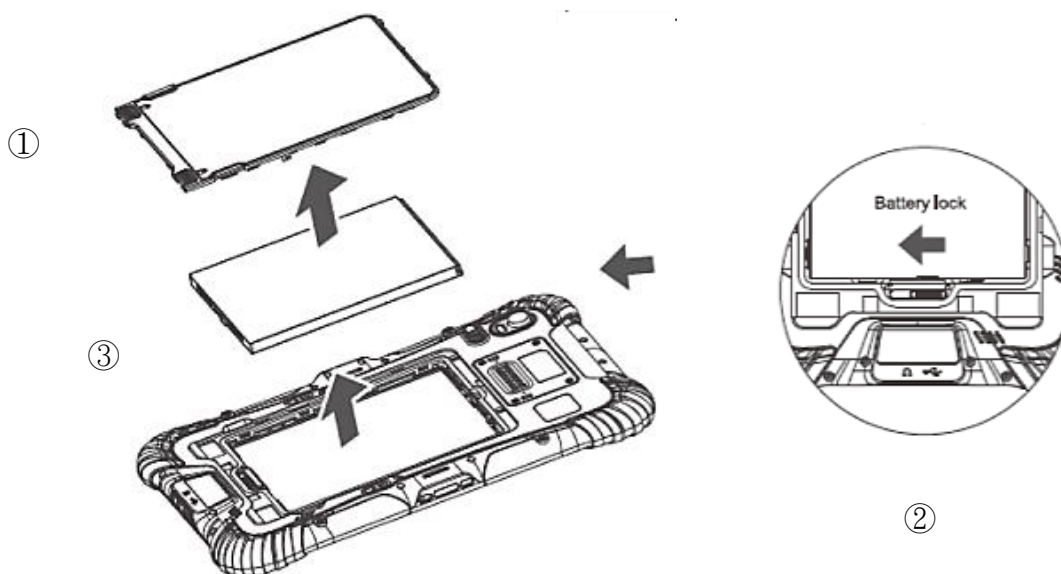

FIG. 1



1.4.6 Charging the Battery

Connect the cable and the device with USB type-c interface, and plug in the other end with adapter.

During normal charging, the home screen status bar will display the charging icon when screen is on. When the charging is completed, the home screen status bar will display the full battery icon when screen is on.



WARNING! There is a risk of fire and burns if the battery is handled improperly. DO NOT disassemble, crush, puncture, short external contacts, or dispose the battery pack in fire or water. DO NOT attempt to open or service the battery. Dispose of used batteries according to local recycling guidelines in your area.

1.4.7 Checking LED Status

LED	Description
Red Light	Battery charging
Blue Light	Battery fully charged

1.4.8 Battery Status

The TB85 Plus provides **battery info** for users to check the battery status, history view and also set up users preferences.

1. On the main screen, scroll the screen from bottom to top to reach the

APPS, and tap  **Settings** and then tap **Battery**.

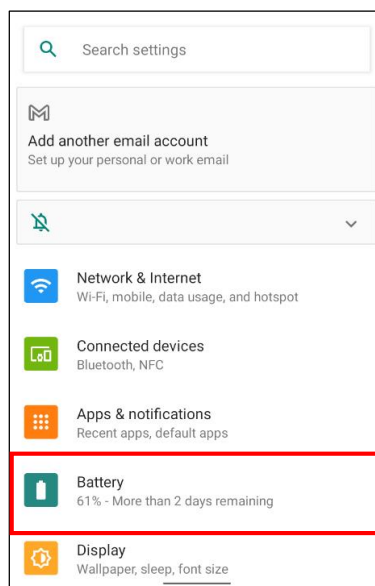

2. **Battery** shows the details of the battery usage.

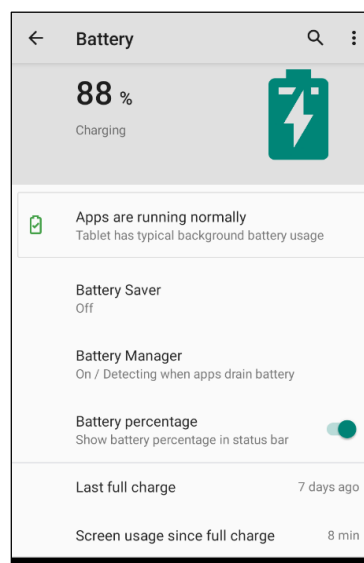

Chapter 2 – Installation & Operation

2.1 TB85 Plus 2D module Assembly

(Only available for TB85 Plus -QALFUMDG)

Peel off the transparent protection film (red arrow) from terminal.



2D module Assembly

Step 1: Align the TB85 Plus 2D module with the four terminals of the device.

Step 2: Secure the 2D module by inserting and tightening four screws on the back of TB85 Plus.



2.2 HF Setting

1. On the main screen, scroll the screen from bottom to top to reach the

APPS, tap  **Settings** and then tap **Connected devices**.

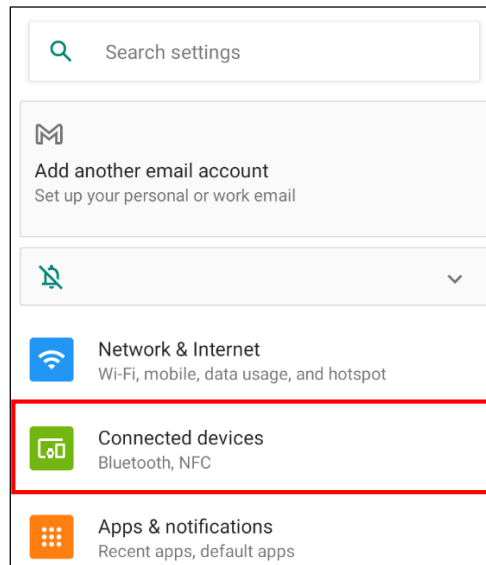

2. Tap **Connection preferences**.

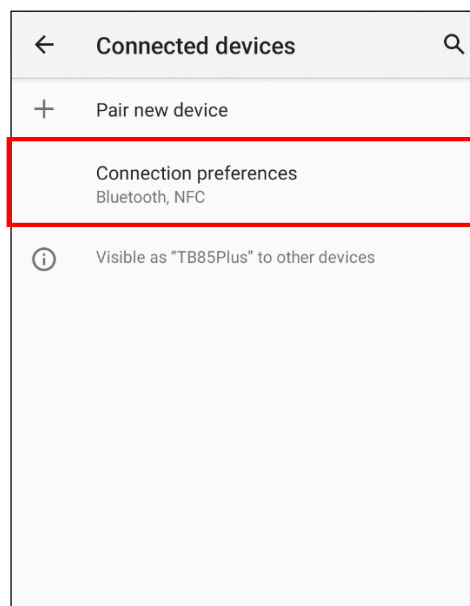

3. Tap **NFC** to enable **NFC**

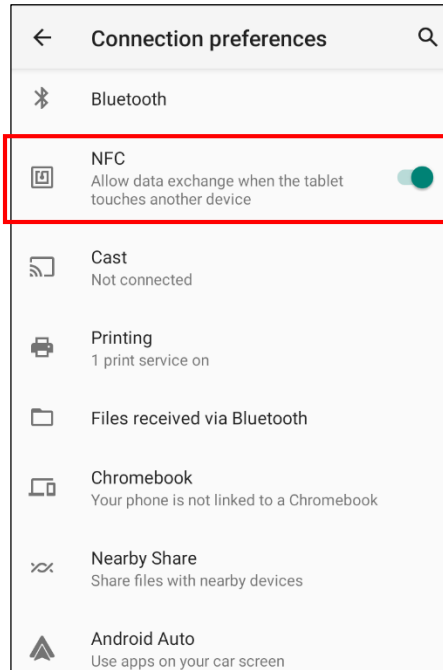

4. Make sure that both devices are unlocked and have NFC turned on. Slightly holding the two devices close together back to back until a connection is made. Tap the screen.

2.3 WWAN Setting

1. Turn off the device to insert the SIM card.

Note : For the instruction, please refer to [1.4.3 Insert Micro SD/ Nano SIM card](#)

2. Turn on the device, 4G signal will show at the top of the screen.

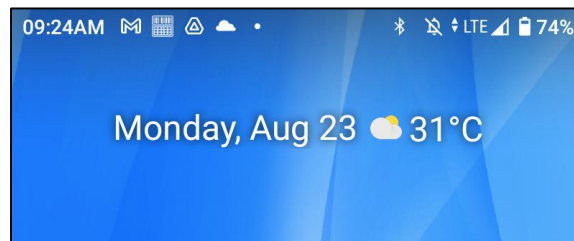

2.3.1 Mobile Network Settings

1. On the main screen, scroll the screen from bottom to top to reach the

APPS, and tap  **Settings** and then tap **Network & Internet**.

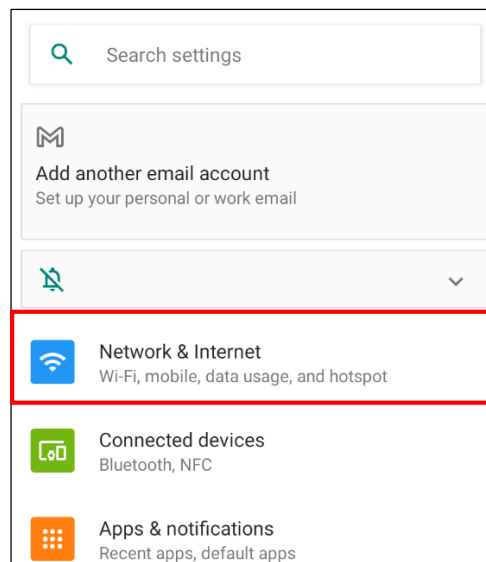

2. Tap **Mobile network** for more network settings.

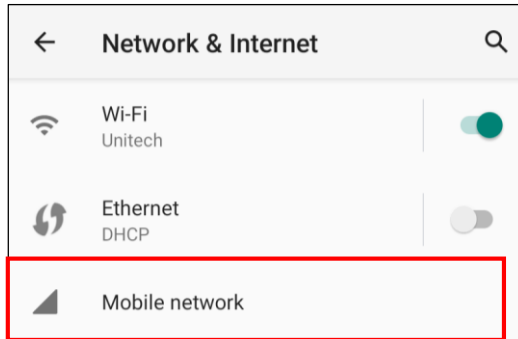

3. To choose different network type, please tap **Preferred network type**.

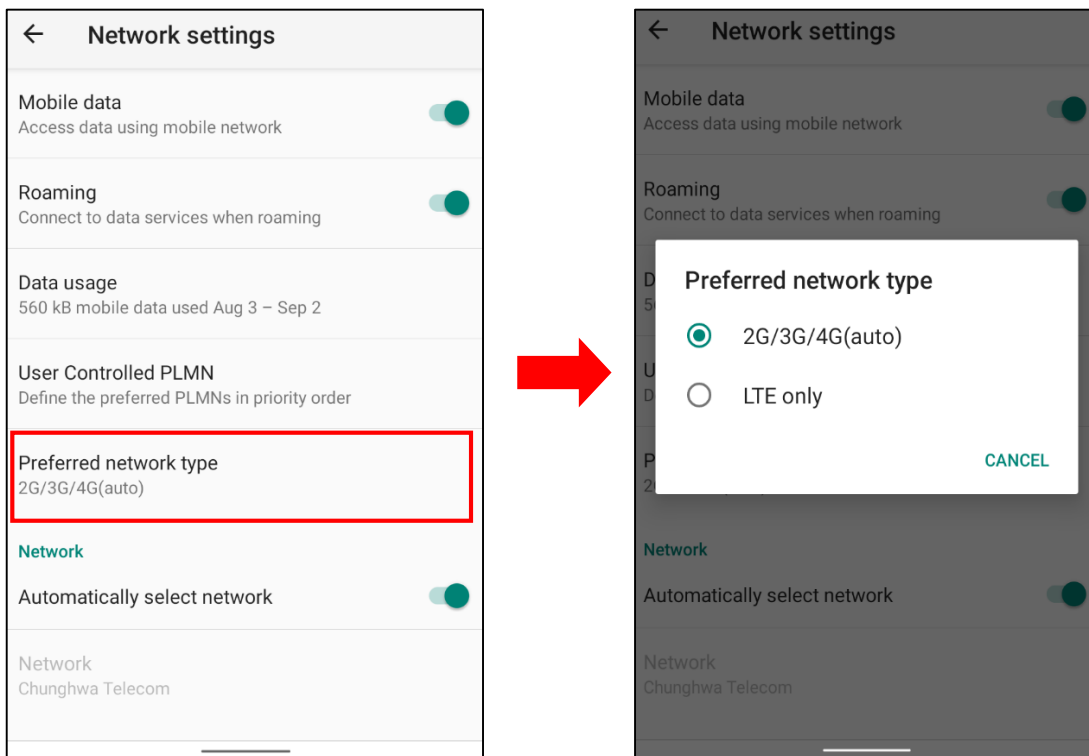

2.4 WLAN Setting

1. On the main screen, scroll the screen from bottom to top to reach the

APPS, and tap  **Settings** and then tap **Network & Internet**.

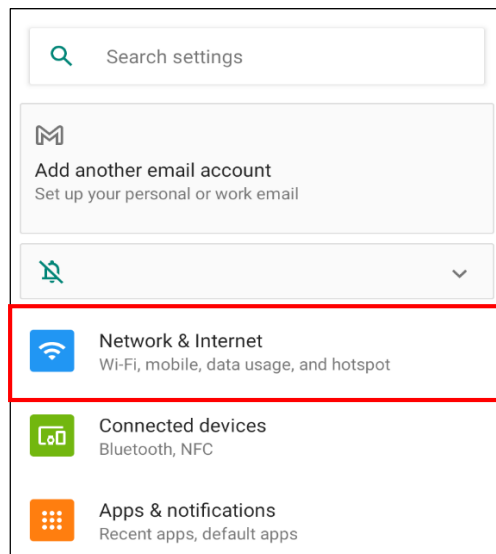

2. To see available networks, turn Wi-Fi **ON**, and tap to choose the available networks.

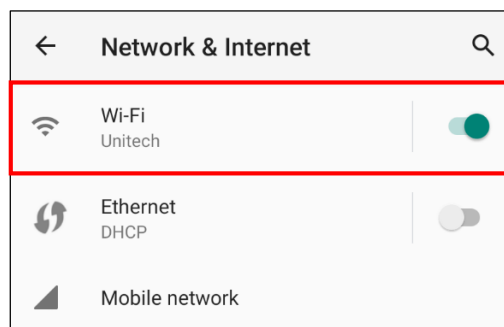

3. Choose the available networks, and enter the Password then tap **Connect**.

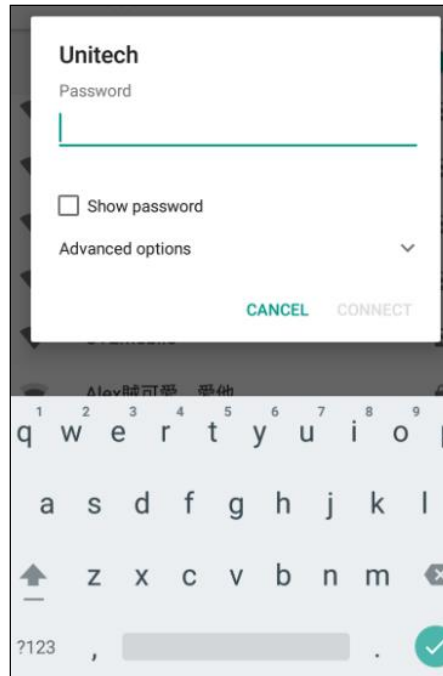

4. If the wireless network that you want is not listed, tap **+ Add network** to manually add it.

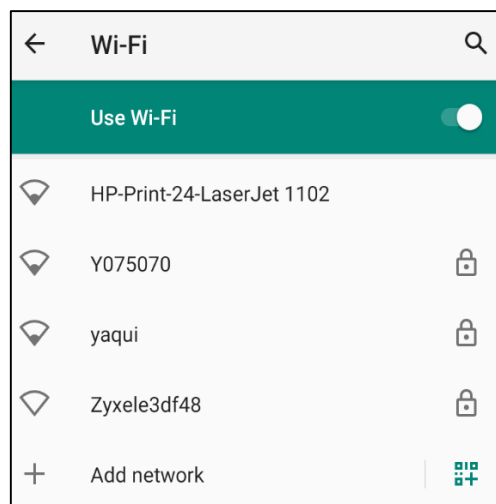

5. When enabled, the Wi-Fi icon  is displayed on the status bar.

2.5 PAN Setting

1. On the main screen, scroll the screen from bottom to top to reach the

APPS, and tap  **Settings** and then tap **Connected devices**.

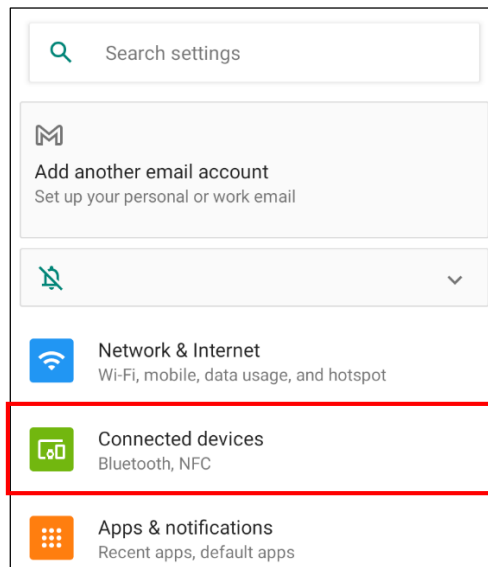

2. Tap **Connection preferences**.

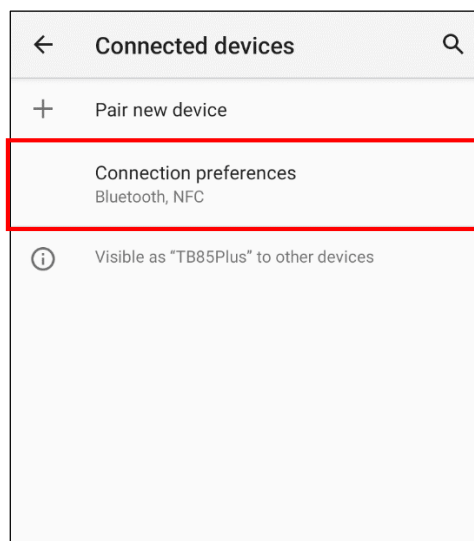

3. Tap **Bluetooth®**.

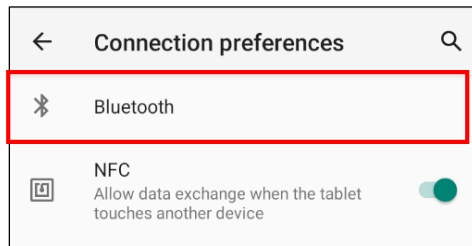

4. Tap **ON / OFF** to enable / disable Bluetooth®.
To pair the available device, turn Bluetooth® **ON** to choose the available device.

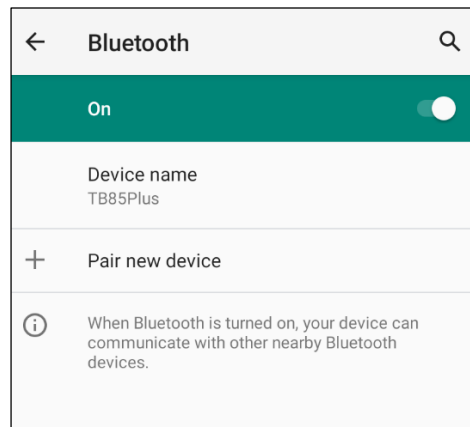

2.6 GPS Setting

1. On the main screen, scroll the screen from bottom to top to reach the

APPS, and tap  **Settings** and then tap **Location**.

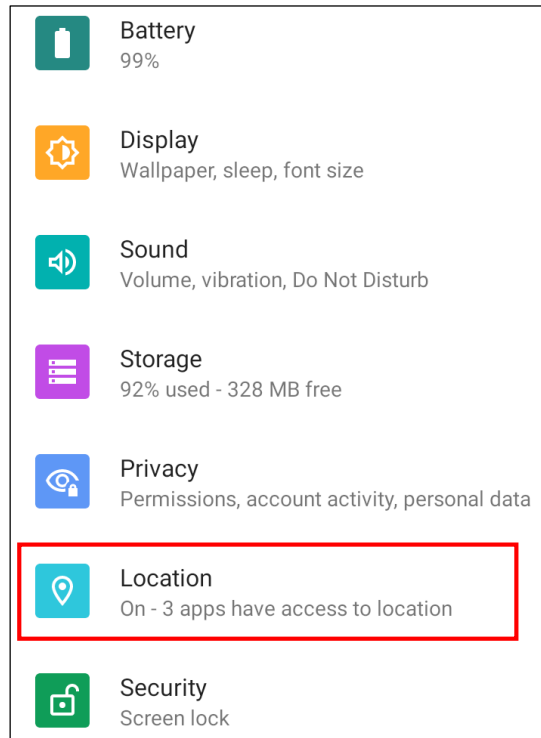

2. Tap **Use location** to open the permission to use your location information.

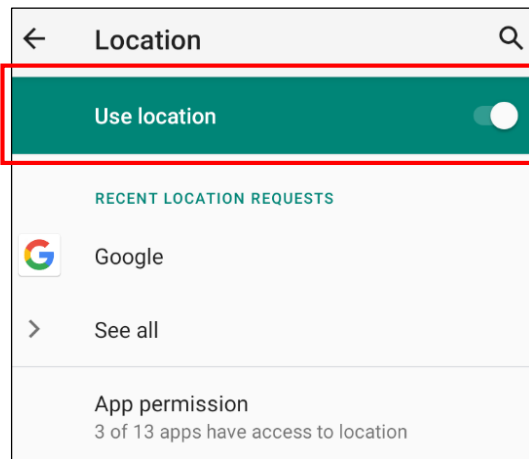

2.7 PC Setting

1. Connect TB85 Plus to your computer with the USB type C cable. Your computer will recognize it as USB charging.

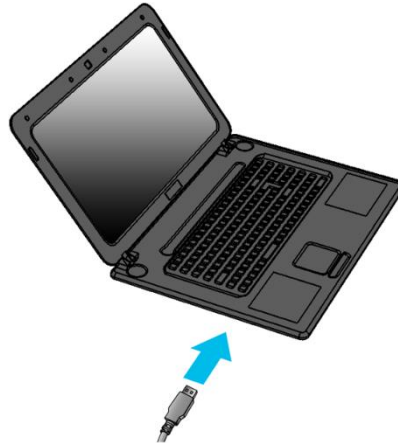

2. Slide from top to bottom, the system will show as follow the picture, then tap on Android System • Charging this device via USB.

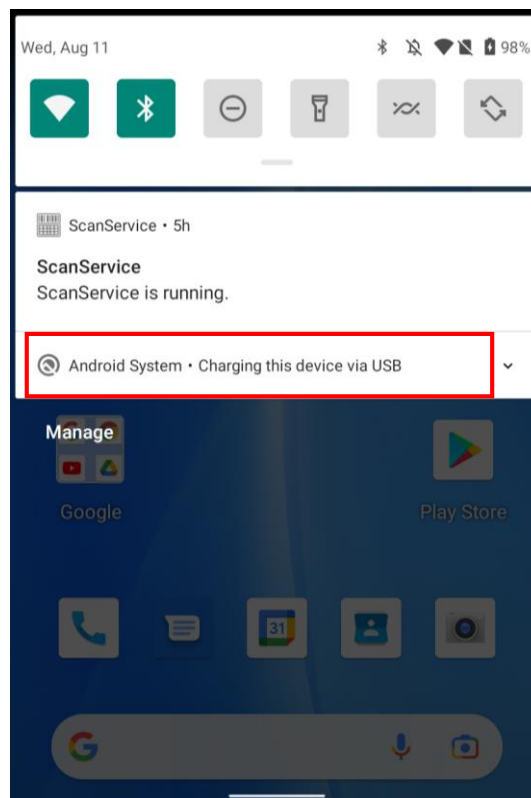

3. Tap on **Charging the device via USB**

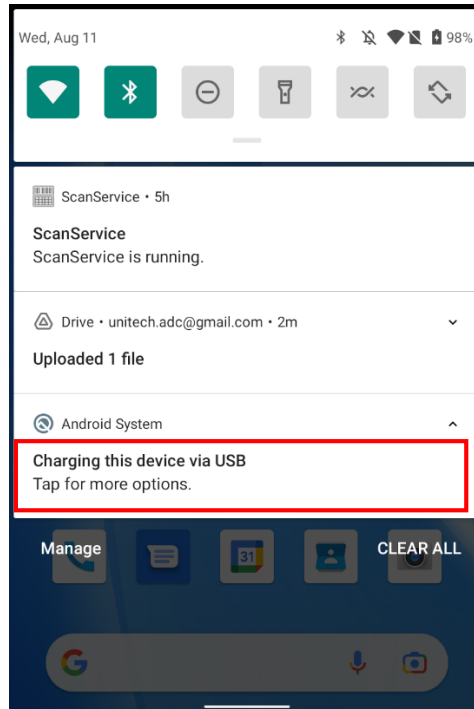

Note: If you cannot find the Android System • Charging this device via USB notification in step 2, click on CLEAR ALL and try again.

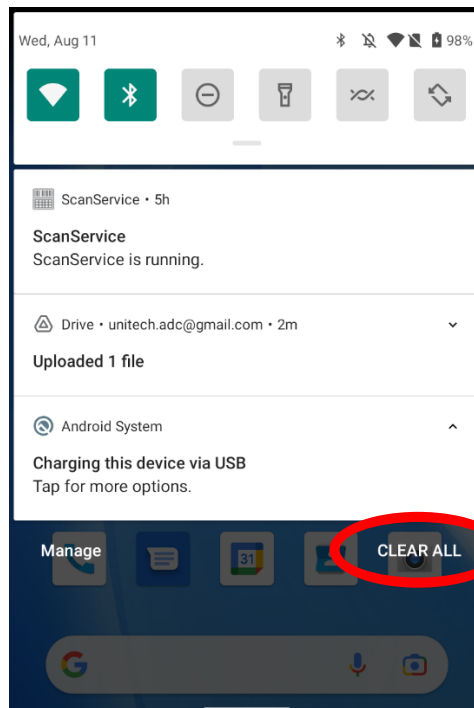

4. Then you can select File Transfer.

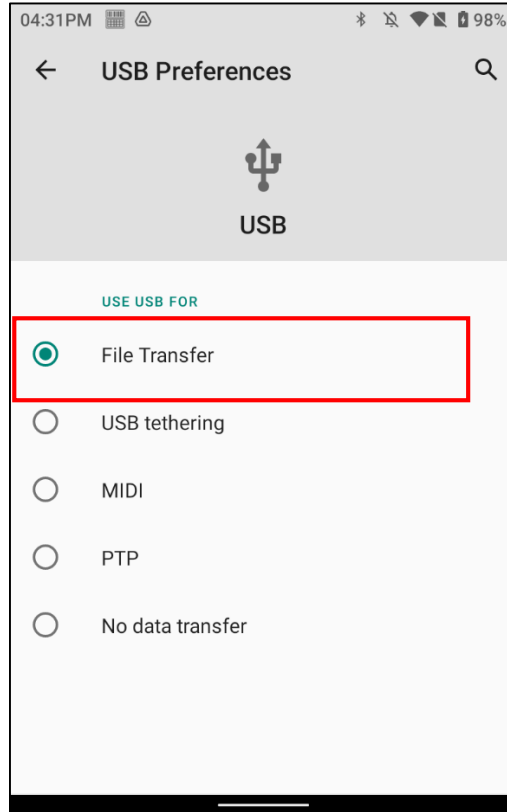

2.8 Camera Settings



1. Tap **Camera** on the main screen, or scroll the screen from bottom to top to reach the APPS, and tap **Camera**.

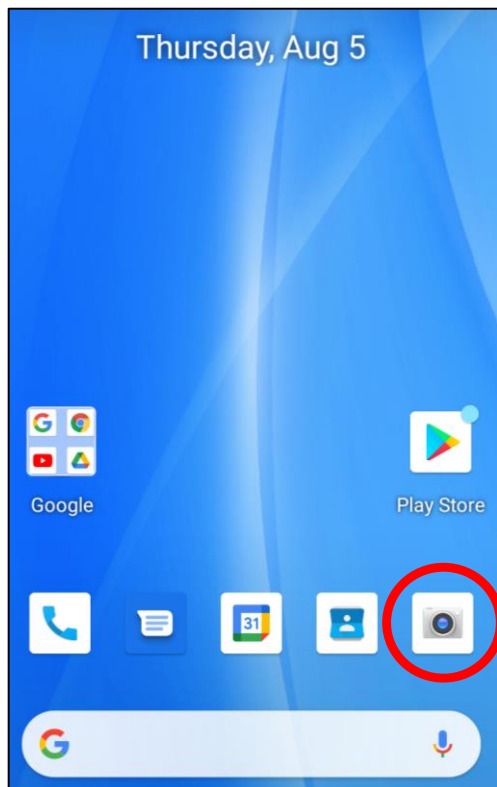

OR

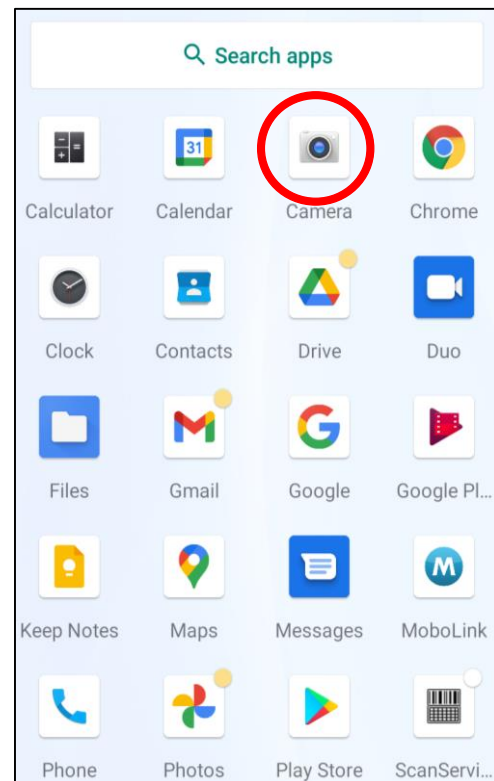

2.8.1 Introduction

For the first time turn on, the screen will show a brief introduction about camera settings.

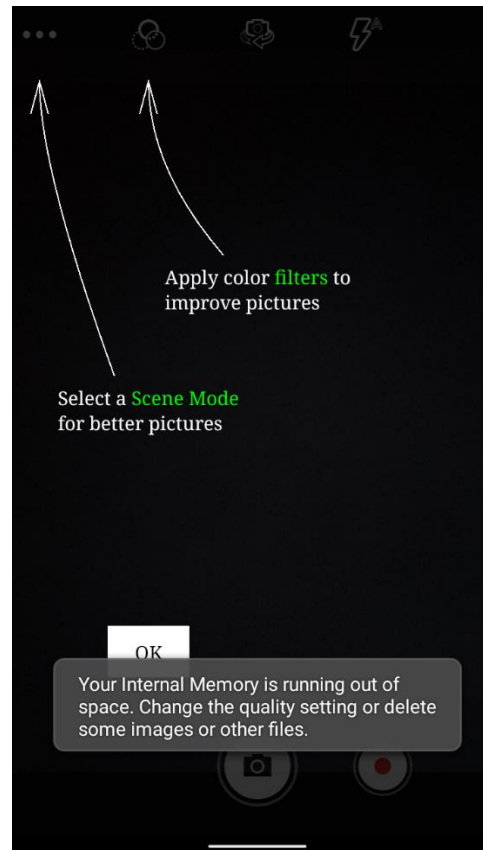

2.8.2 Camera / Video mode

Tap  to switch to video mode

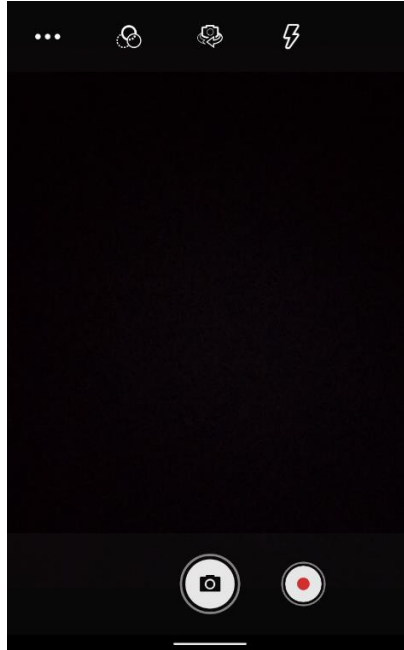

2.8.3 Camera filter effects

Scroll left to view more filter options.

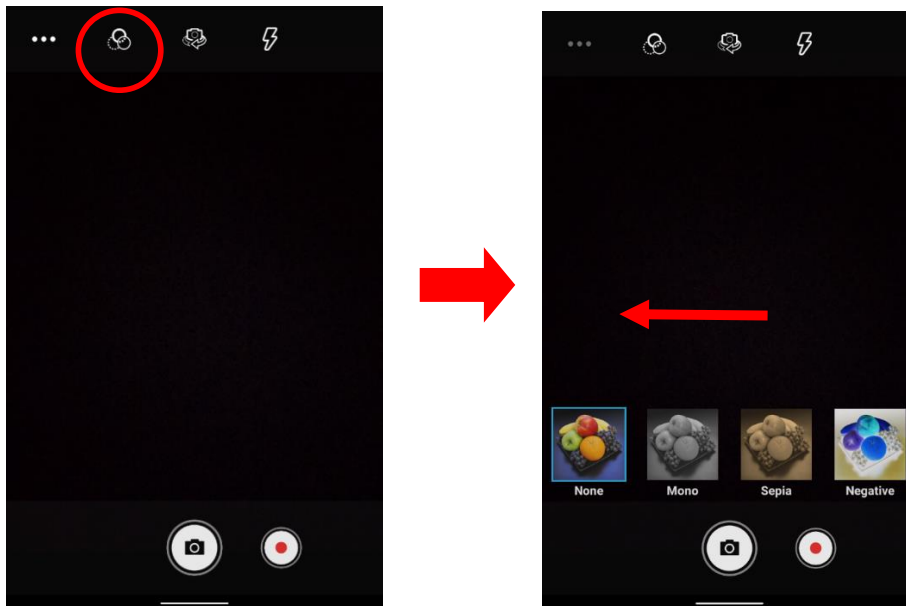

2.8.4 Advanced Settings

Press  then press  to access advanced setting.

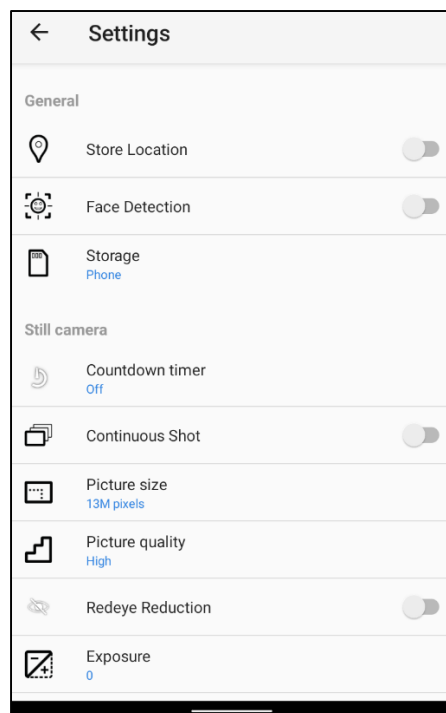
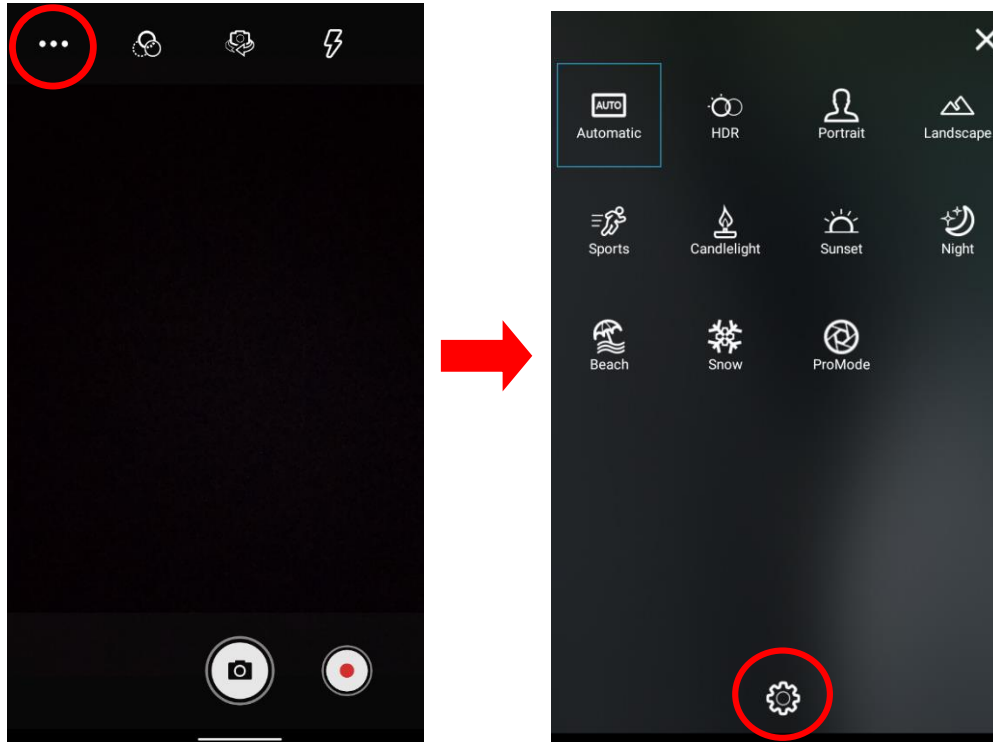

2.8.5 Mode Settings

Press  to access mode setting.

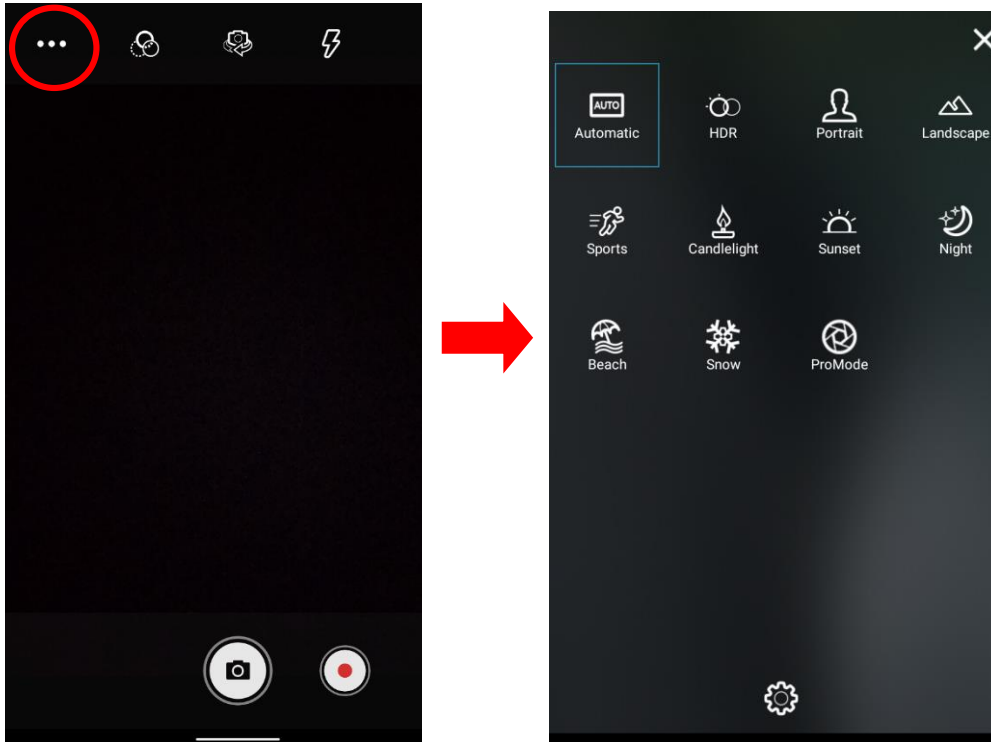

2.9 Dark Theme and Night Light

2.9.1 How to Enable Dark Theme

Dark mode is a feature that allows you to switch to the dark theme on an app or an entire desktop operating system.

1. On the main screen, scroll the screen from bottom to top to reach the

APPS, and tap  **Settings** and then tap **Display**.

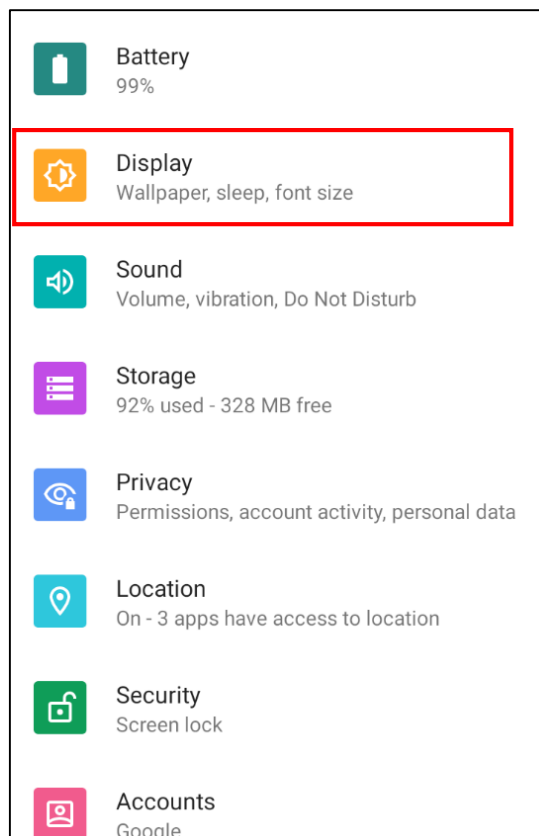

2. Tap **Dark theme** to enable dark theme.

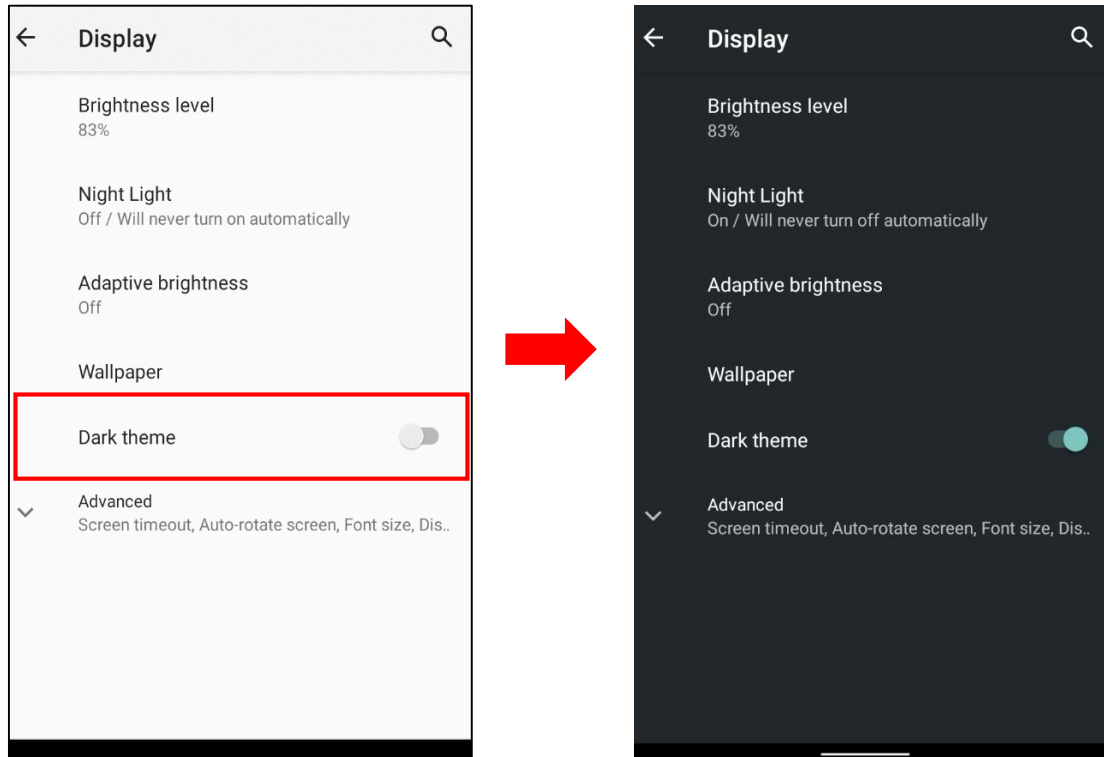

2.9.2 How to Enable Night Light

Night Light is a feature that tints your screen amber, making it easier to look at the screen or read in dim light, and may help you fall asleep more easily.

1. On the main screen, scroll the screen from bottom to top to reach the

APPS, and tap  **Settings** and then tap **Display**.

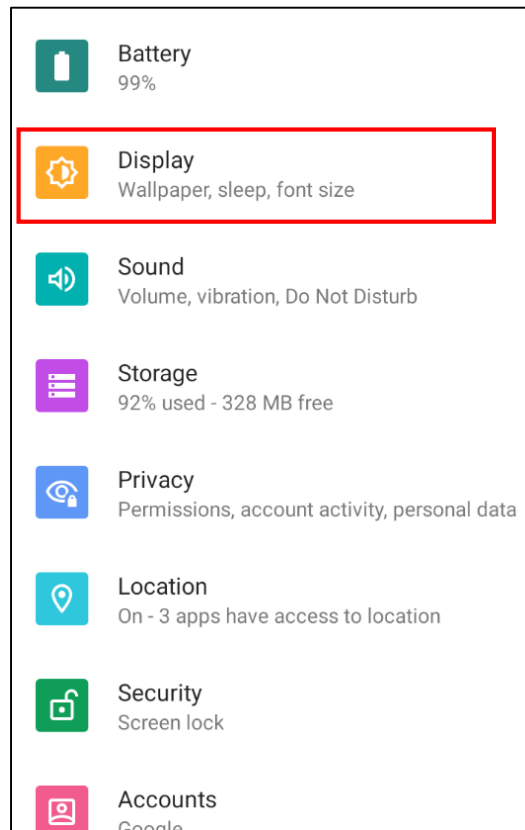

2. Tap on **Night Light** and tap **TURN ON NOW** to enable night light.

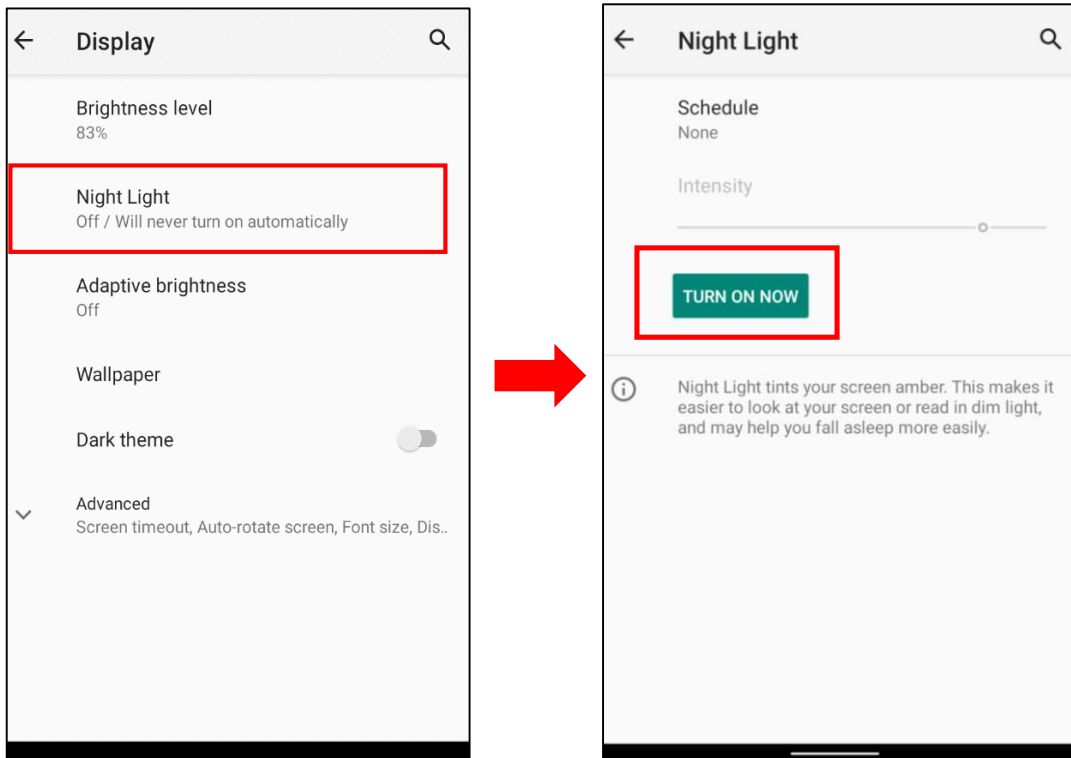

2.10 Performing a Hardware Reset

You may have to perform a reset if the device freezes (i.e., the device no longer responds to the buttons or tapping on the screen).

Long press and hold **Power button** around 16 seconds to restart the device.

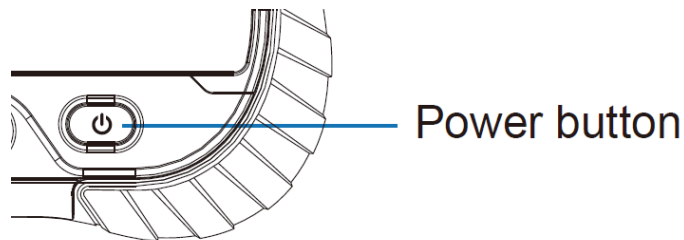

2.11 Performing a Factory Data Reset

1. On the main screen, scroll the screen from bottom to top to reach the

APPS, and tap  **Settings** and then tap **System**.

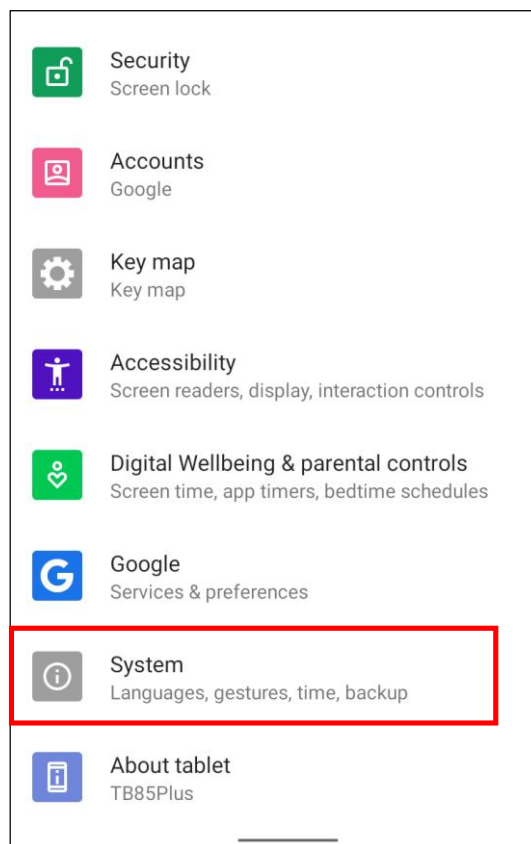

2. Tap **Reset options** for more options.

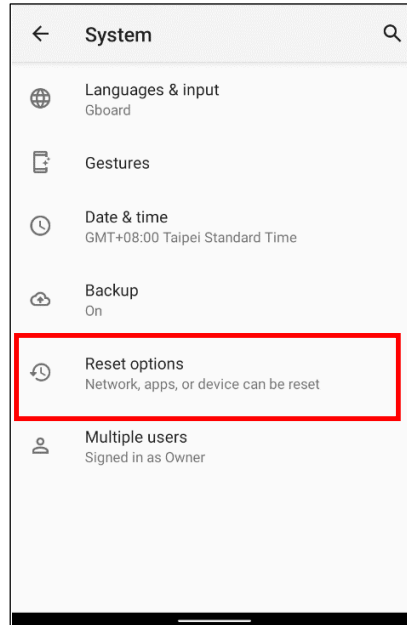

3. You can reset the system on **Reset Options**.

When you select **Factory data reset**, it will erase all folders.

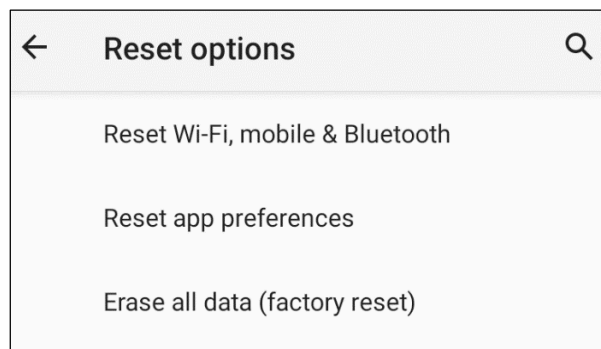

2.12 How to map the F1 & F2 Key

1. Settings→ Key map→ Key→ Value
2. Key item, there are four keys that can be remapped and default values on the brackets as shown in the below list:
 - Volume Up/(Volume Up)
 - Volume Down/(Volume Down)
 - F1/(Disable)
 - F2/(Disable)

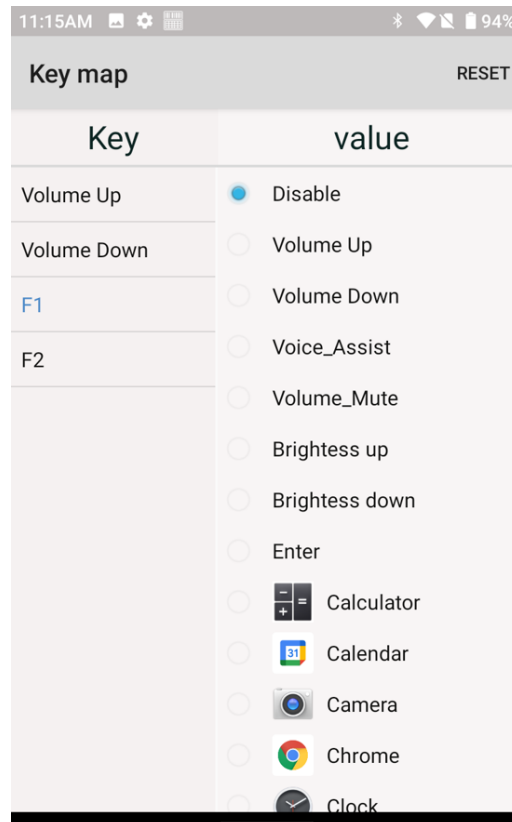

3. Value item, include the commands and APPs that you can remap, see above shown.

- Map the F1 key and F2 key to the below command or APP that you wonder to map.

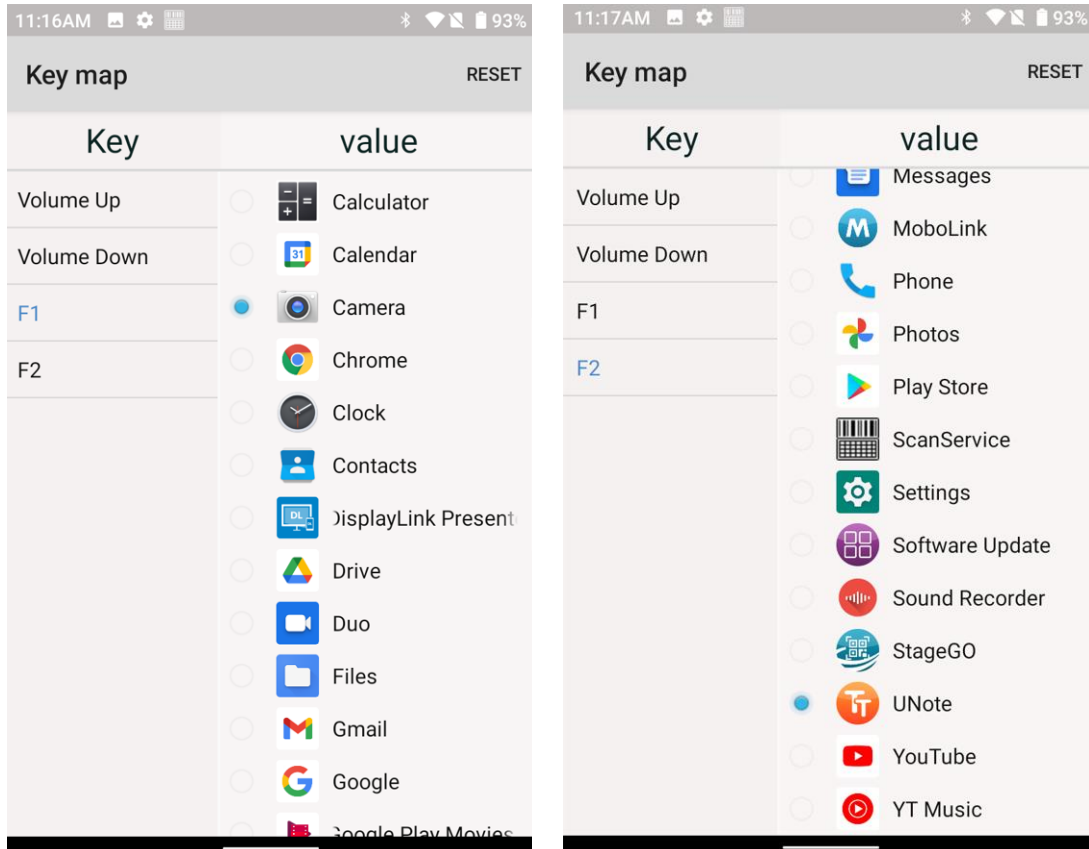

- Once you finished the set, you can press the F1 key or the F2 key to launch the command or the APP that you already defined.

Chapter 3 – Introduction to Applications

3.1 Scan Service

3.1.1 How to Scan

1. On the main screen, scroll the screen from bottom to top to reach the

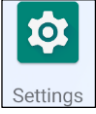
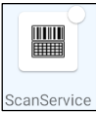
APPS, and tap  **Settings** and then tap  **ScanService**.
Or from the notification bar to tap **ScanService**.

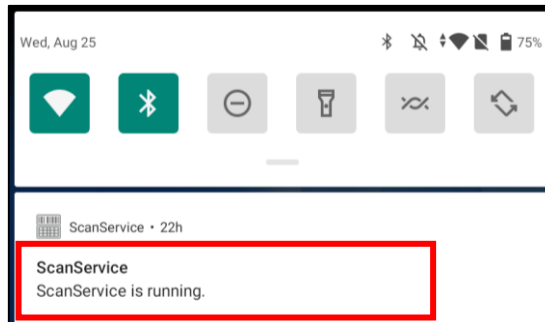

2. You have now entered the unitech scan service application.

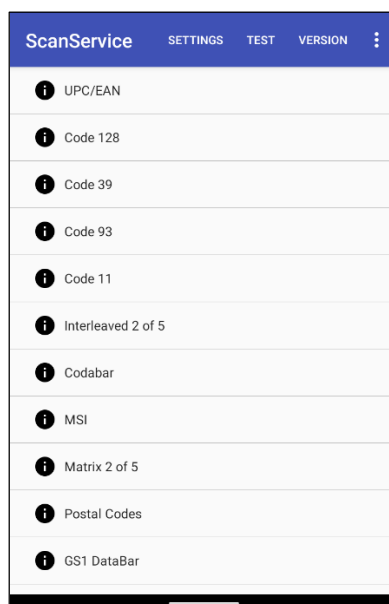

3. Tap the **TEST** Option.

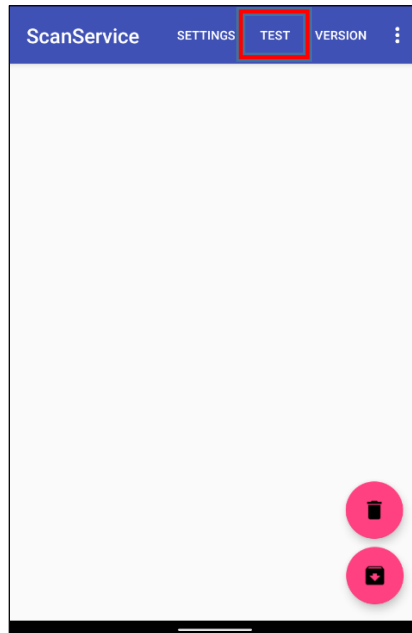

4. Press and hold one of the two scanner trigger keys and aim the barcode scan engine at the barcode.



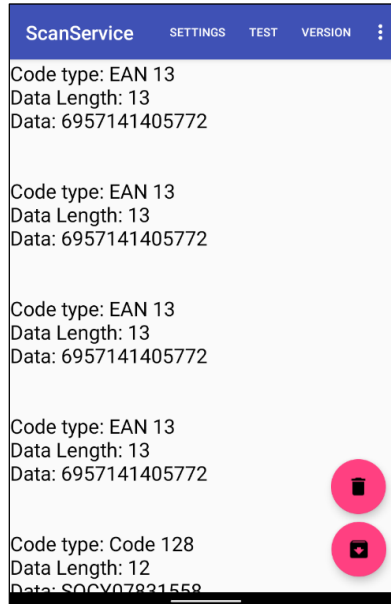

5. After scanning the barcodes, the barcode information is shown as below.

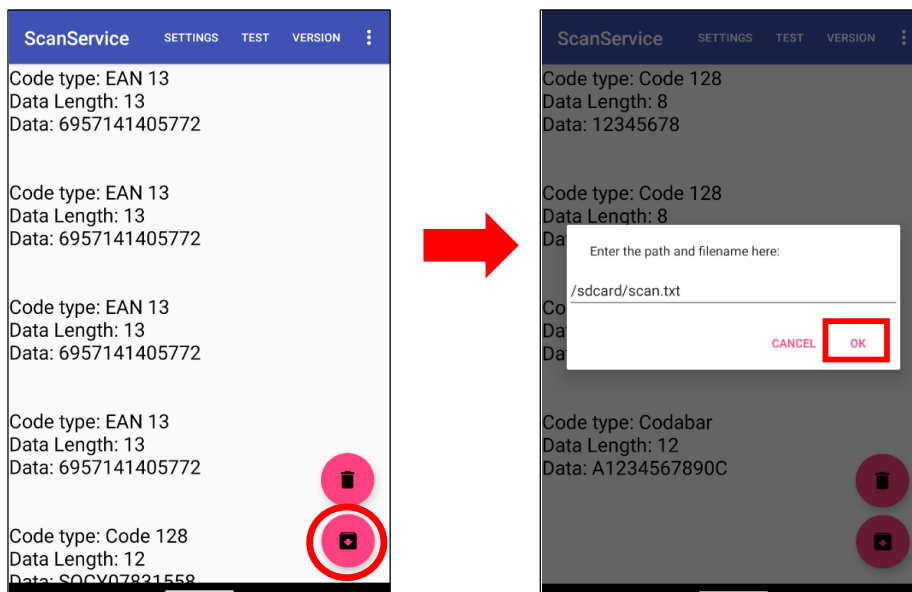

3.1.2 Save/Clear the Scanned data

To save the scanned data, tap  and enter the path and filename, then tap OK.



Tap  to clear the scanned data.

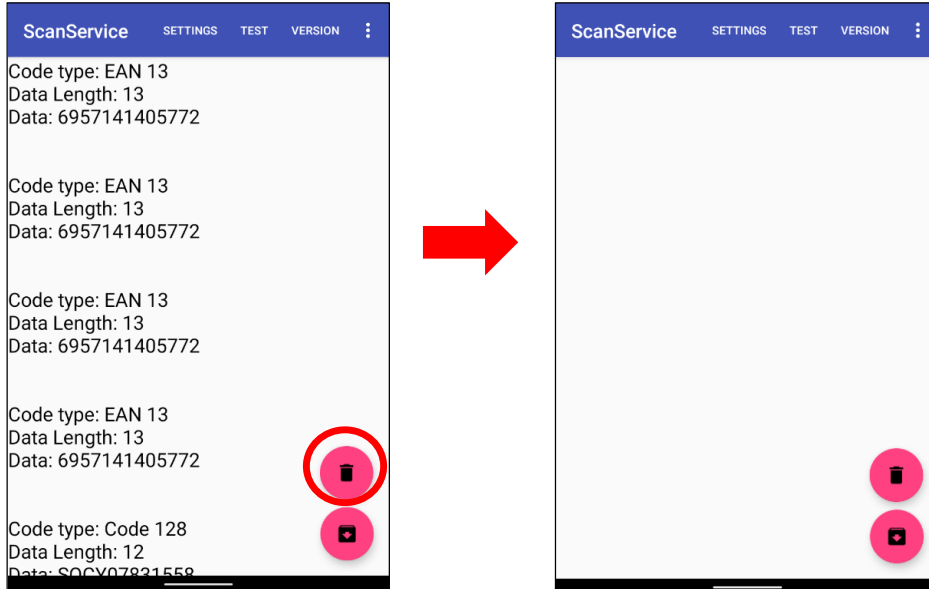

3.1.3 More Options

For more options and settings, please tap .

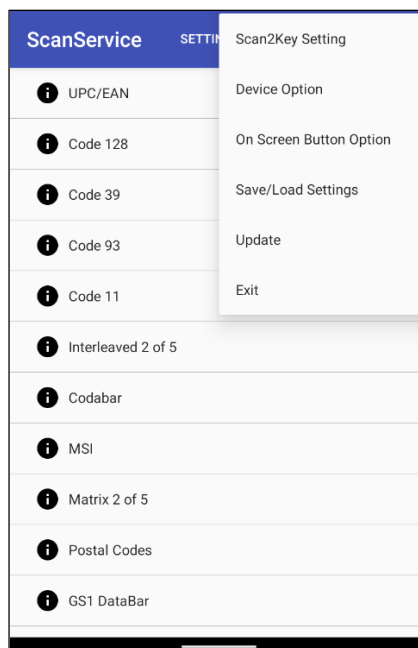

3.1.4 More information about Scan Service

For more information about unitech scan service, please download the document through the link below:

http://w3.tw.ute.com/pub/cs/manual/uss/USS-RA-1-MANUAL_en20210326.pdf

3.2 StageGO

StageGO is a barcode-based device staging solution from unitech. StageGO helps IT admins to swiftly set up a device by just a few barcode scans.

Features

- Swift and effortless device staging for Unitech Android Mobile Devices.
- Device staging becomes more accessible, time-efficient, and secure.
- Complete device control at your fingertips.
- Data Compression.
- Security and Privacy.
- No installation required.

Using StageGO to configure a device is in 3 simple steps:

Step1: Create Script –



Create Script

It all begins with IT staff creating a StageGO Script on the easy-to-use and secure web-based Script Editor. A StageGO script can contain one or more staging commands such as change system settings, connect to WiFi, download files, install apps, or set restrictions, etc.





**Print
QRCode**

This is when the script is ready to be transformed into QR Codes and get printed out for distribution to the fields. The QR Codes are always encrypted so that sensitive information such as username and passwords will stay hidden. You can also choose to save your script as an encrypted file and share it with a colleague.

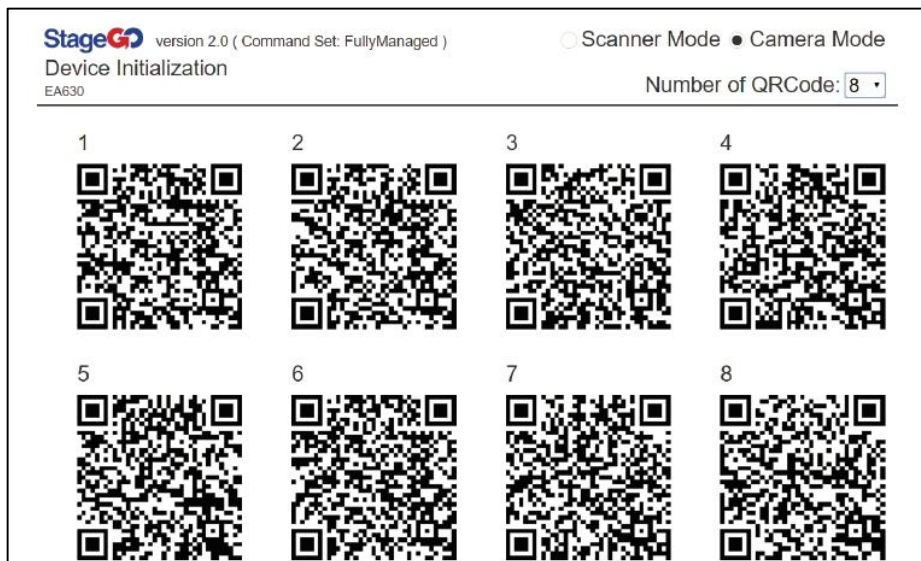

Step 3. Scan QRCode:



Scan
QRCode

The device user scans all the QRcodes into the StageGO app, or alternatively load script from file. The script will then automatically start to execute. Users will be informed of the progress of the execution, and should any execution errors occur, the execution report can be shared to IT admins for investigation.

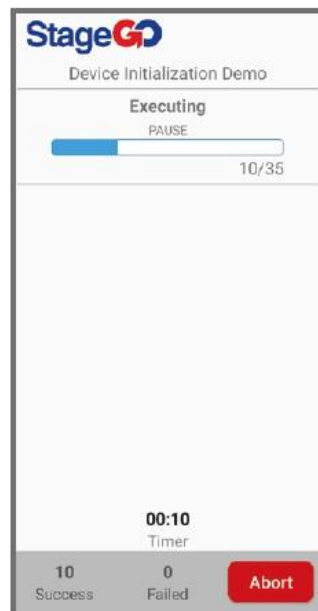
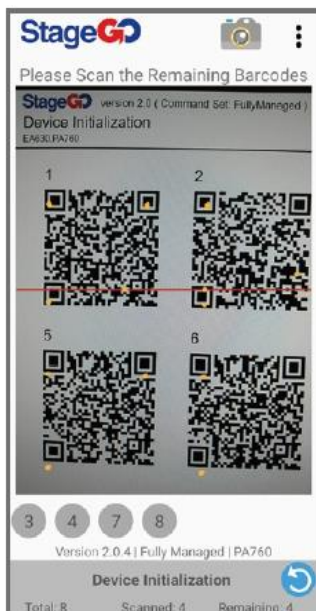

3.3 Software Update

Software update lets you check for updates of the unitech applications installed on this device. It also lets you to install new applications as they become available for this device. Please make sure your device is connected to the internet before checking for updates.

On the main screen, scroll the screen from bottom to top to reach the APPS,

and tap  **Software Update.**

1. Tap **CHECK UPDATE** button to start checking for updates.

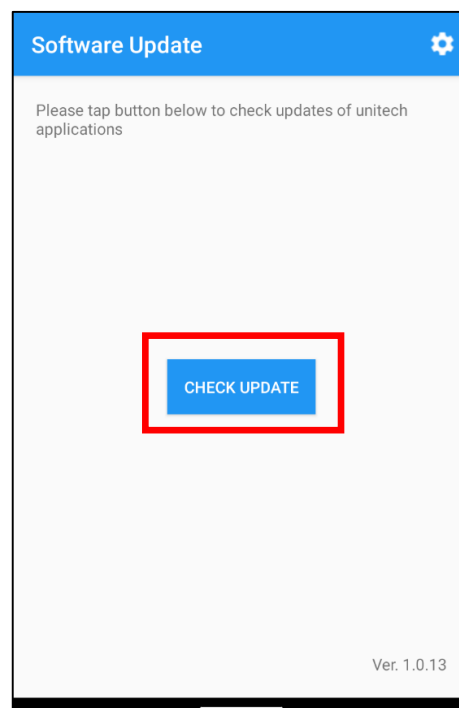

2. If there are available updates, select the ones you wish to update, and then tap the **UPDATE** button to continue.

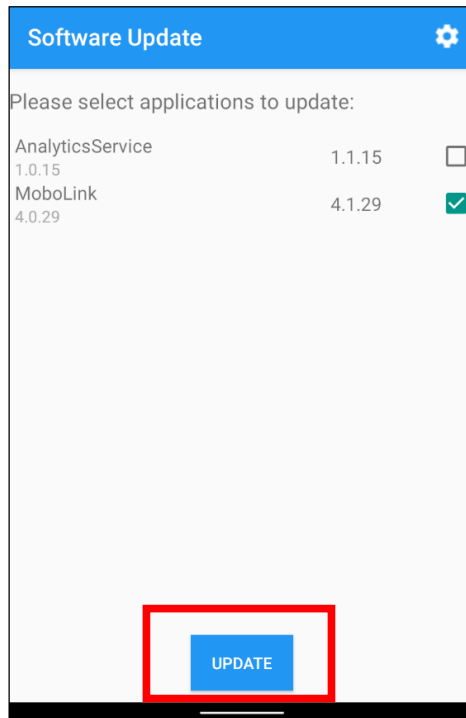

3. When updates are complete, tap the **OK** button to go back to home page.

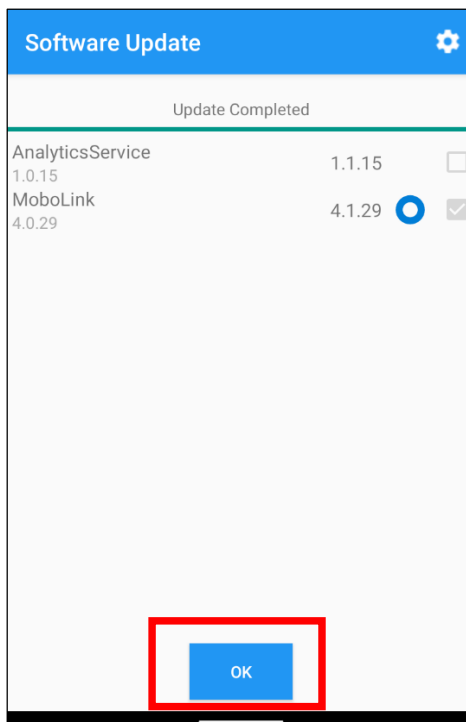

3.4 MoboLink

MoboLink is a software platform that helps unitech customers to remote manage their purchased devices and applications. The core of the MoboLink platform provides functionalities in the MDM (Mobile Device Management) and MAM (Mobile Application Management) domains, and then further extends into other management functions such as alert notification management and account management.

On the main screen, scroll the screen from bottom to top to reach the APPS,



and tap **MoboLink**.

